

REPORT

City of Edmonton

2019-3585

Rainbow Valley Bridges Renewal & Widening Terwillegar Drive Stage 2 Upgrades Environmental Impact Assessment



JANUARY 2022

CONFIDENTIALITY AND © COPYRIGHT

This document is for the sole use of the addressee and Associated Engineering Alberta Ltd. The document contains proprietary and confidential information that shall not be reproduced in any manner or disclosed to or discussed with any other parties without the express written permission of Associated Engineering Alberta Ltd. Information in this document is to be considered the intellectual property of Associated Engineering Alberta Ltd. in accordance with Canadian copyright law.

This report was prepared by Associated Engineering Alberta Ltd. for the account of City of Edmonton. The material in it reflects Associated Engineering Alberta Ltd.'s best judgement, in the light of the information available to it, at the time of preparation. Any use which a third party makes of this report, or any reliance on or decisions to be made based on it, are the responsibility of such third parties. Associated Engineering Alberta Ltd. accepts no responsibility for damages, if any, suffered by any third party as a result of decisions made or actions based on this report.

TABLE OF CONTENTS

SECTION	PAGE NO.
Table of Contents	i
List of Tables	iii
List of Figures	iv
1 Introduction	1-1
2 The Property	2-1
2.1 Land Use and Zoning	2-1
3 Environmental Context	3-1
3.1 Assessment Methods	3-1
3.2 Groundwater, Surface Water, and Fish	3-2
3.3 Geomorphology, Geology, and Soils	3-8
3.4 Vegetation	3-8
3.5 Wildlife	3-13
3.6 Historical Resources	3-19
3.7 Contaminated Sites	3-22
4 The Project	4-1
4.1 Rainbow Valley Bridges Rehabilitation and Widening	4-1
4.2 New Pedestrian / Cyclist Bridge over Whitemud Creek	4-2
4.3 Retaining Walls	4-2
4.4 Landscape Restoration and Enhancement	4-2
5 Regulatory Framework	5-1
6 Project Impacts and Mitigation Measures	6-1
6.1 Environmental Impacts	6-1
6.2 Identifying Cumulative Impacts	6-5
6.3 Mitigation Measures	6-10
7 Environmental Monitoring	7-1
8 Public Consultation	8-1
9 Conclusions and Supporting Information	9-1
Closure	
References	
Appendix A – Historical Resources Overview Report, Historical Resources Impact Assessment, and Approval	
Appendix B - Wildlife Passage Engineering Design Guidelines	
Appendix C - Draft Geotechnical Investigation Reports	
Appendix D - Limited Phase I Environmental Site Assessment	
Appendix E - Phase II Environmental Site Assessment	

Appendix F - Contaminated Soils Management Strategy

Appendix G - Draft Preliminary Design Drawings

Appendix H - Draft Noise Impact Assessment

Appendix I - Site Location Study

LIST OF TABLES

	PAGE NO.
Table 2-1 Environmental Sensitivity Class	2-2
Table 3-1 Alberta Environment and Parks Water Wells Within 500 m of the Project Area	3-2
Table 3-2 Fish Species Identified in Whitemud Creek	3-4
Table 3-3 Elemental Occurrences Within 2km of the Project Area	3-10
Table 3-4 Wildlife Species of Conservation Concern Previously Recorded Within or Near the Study Area	3-15
Table 5-1 Anticipated Environmental Permitting Required for the Project	5-2
Table 5-2 Environmental Legislation and Recommendations for General Compliance	5-5
Table 6-1 Project Impacts on Groundwater, Surface Water, and Fish	6-1
Table 6-2 Project Impacts on Geomorphology, Geology, and Soils	6-2
Table 6-3 Project Impacts on Vegetation	6-3
Table 6-4 Project Impacts on Wildlife	6-4
Table 6-5 Project Impacts on Historical Resources	6-5
Table 6-6 Project Impacts on Contaminated Sites	6-5
Table 6-7 Mitigation Measures to Address Environmental Impacts of the Project	6-11

LIST OF FIGURES

	PAGE NO.
Figure 2-1 Project Overview and Zoning of Fox Drive Interchange	2-5
Figure 2-2 Project Overview and Zoning of Rainbow Valley Bridges	2-6
Figure 2-3 Environmental Sensitivity Scores at Fox Drive Interchange	2-7
Figure 2-4 Environmental Sensitivity Scores at Rainbow Valley Bridges	2-8
Figure 3-1 View of Whitemud Creek Looking Downstream (North)	3-4
Figure 3-2 Groundwater, Surface Water, and Topography at Fox Drive Interchange	3-6
Figure 3-3 Groundwater, Surface Water, and Topography at Rainbow Valley Bridges	3-7
Figure 3-4 Vegetation at Fox Drive Interchange	3-11
Figure 3-5 Vegetation at Rainbow Valley Bridges	3-12
Figure 3-6 Wildlife Fox Drive Interchange	3-17
Figure 3-7 Wildlife Rainbow Valley Bridges	3-18
Figure 3-8 Historical Resource at Fox Drive Interchange	3-20
Figure 3-9 Historical Resources at Rainbow Valley Bridges	3-21
Figure 4-1 Project Components Fox Drive Interchange	4-3
Figure 4-2 Project Components Rainbow Valley Bridges	4-4
Figure 6-1 Planned Vegetation Removal and Retention Areas	6-7
Figure 6-2 Planned Vegetation Removal and Retention Areas	6-8
Figure 6-3 Planned Vegetation Removal and Retention Areas	6-9

1 INTRODUCTION

Terwillegar Drive, in Edmonton, Alberta, connects Whitemud Drive to Anthony Henday Drive and ultimately south to Highway 19. The roadway was originally envisioned to be a freeway to improve movement around the city. In 2019, the City of Edmonton (the City) hired Associated Engineering Alberta Inc. (Associated) and CIMA+ to undertake a functional planning and bridge assessment study to determine rehabilitation options for the Rainbow Valley Bridges, express transit routing options, and capacity improvements. The Terwillegar Drive upgrade project is divided into three stages:

Stage 1: Terwillegar Drive Expressway including widening to four lanes in each direction, a shared-use path along the east side of the corridor, and intersection upgrades with enhanced bus stops. *This stage began in 2020 and is currently under construction.*

Stage 2: Whitemud Drive / Terwillegar Drive Interchange, Rainbow Valley Bridges including Whitemud Drive upgrades and widening from Fox Drive to 122 Street, rehabilitation and widening of the Rainbow Valley Bridges to four lanes in each direction, upgrades to the shared use pathway between 122nd street and Fox Drive, Whitemud Drive / Terwillegar Drive interchange ramp upgrades, transit priority measures throughout the project area, and a pedestrian bridge over Whitemud Creek north of the existing bridges. Stage 2 is a part of the City's plan to support the projected growth of travel demand in southwest Edmonton.

Stage 3: Anthony Henday Drive Interchange Upgrades including additional northbound bridge, ramp upgrades, active mode upgrades and potentially transit priority measures, and Terwillegar Drive / 170 Street widening.

The City retained CIMA+ to undertake preliminary design, detailed design, tender support, resident engineering, and post-construction services for Stage 2. CIMA+ retained Associated to assist with project management, design, and environmental services. This project includes the work associated with Stage 2.

The interchange at Whitemud Drive / Fox Drive and the portion of Whitemud Drive that extends from the west of the Rainbow Valley Bridges to 122 Street are situated in the North Saskatchewan River Ravine System (**Figure 2-1** and **2-2**). As such, project components and activities in these lands are subject to Bylaw 7188 and require environmental review (City of Edmonton 2018). The study area is the extent of the project area that overlaps with the Bylaw 7188 area (**Figure 2-1** and **2-2**). The purpose of this Environmental Impact Assessment is to support the environmental review of the project and satisfy the requirements of Bylaw 7188.

2 THE PROPERTY

2.1 Land Use and Zoning

The project occurs in southwest Edmonton and extends from Fox Drive south to the project limits of Stage 1 between Whitemud Drive and 40 Avenue and east to the intersection of Whitemud Drive with 122 Street (Figure 2-1 and 2-2). The Rainbow Valley Bridges cross Whitemud Creek between 142 Street and 122 Street. The project area covers a 4.9 km segment of the Whitemud Drive freeway and ranges from approximately 100 to 200 metres in width. Currently, the freeway is divided and has three lanes of traffic going in both directions. The Whitemud Drive / Fox Drive interchange accounts for 0.5 km of the project area length. The north-south segment from the Whitemud Drive / Fox Drive interchange to the Whitemud Drive / Terwillegar Drive interchange is approximately 2.3 km. The east-west segment from the Whitemud Drive / Terwillegar Drive interchange to the Whitemud Drive / 122 Street interchange is approximately 2.1 km. The location of the planned pedestrian/cyclist bridge is 250 metres east of Terwillegar Drive, which will connect 142 Street north of Whitemud Drive to a pathway on the south side. The Rainbow Valley Bridges cross Whitemud Creek and are approximately midway between Terwillegar Drive and 122 Street.

The project area intersects the following Alberta Township Survey (ATS) system sections (Figure 2-1 and 2-2):

- NW-07-52-24-W4M;
- SW-18-52-24-W4M;
- NE-11-52-25-W4M;
- NW & NE-12-52-25-W4M;
- SW & SE-13-52-25-W4M;
- NE & SE-14-52-25-W4M;
- SE-23-52-25-W4M; and
- SW-24-52-25-W4M.

The project area intersects the following parcels outside of the road right-of-way:

- 501 - Butchart Drive NW
 - Block F, Plan 22NY
- 4501 - 142 Street NW
 - Block OT, Plan 8822507
- 13140 - Rainbow Valley Road NW
 - Block H, Plan 18KS
- 13110 - Rainbow Valley Road NW
- Lot A, Plan 2815HW
- 13204 - Rainbow Valley Road NW
 - Lot R, Plan 4002MC
- 4145 - Aspen Drive East NW
 - Lot R5, Plan 6773MC
- 7000 - 143 Street NW
 - Block A, Plan 8521469

The dominant land use within the project area is municipal-owned land including major arterial roadways and pedestrian traffic on shared-use paths adjacent to roadways. Current land use within the project area is freeway transportation. Based on the review of municipal zoning plans, the project area is adjacent to multiple zones within Edmonton, most of which are residential (City of Edmonton 2021a):

- A: Metropolitan Recreation Zone
- AGU: Urban Reserve Zone
- AN: River Valley Activity Node Zone
- AJ: Alternative Jurisdiction Zone
- AP: Public Parks Zone
- DC2: Site Specific Development Control Provision
- RA7: Low Rise Apartment Zone
- RF1: Single Detached Residential Zone
- RF5: Row Housing Zone
- US: Urban Services Zone

Most of the area surrounding the project area is developed and consists of residential areas (AJ, DC2, RA7, RF1, RF5). Other land uses include schools (AGU and US), churches (US), public parks (AP), and the recreational park area surrounding Whitemud Creek (A). Lands zoned as A and AP are regulated under the Parkland Bylaw, details regarding the Parkland Bylaw can be found in [Section 5](#). The recreational park area has multiple trails, a campground, and the Snow Valley Ski Club. The boundaries of the North Saskatchewan River Valley and Ravine System are shown on [Figures 2-1](#) and [2-2](#).

Most of the lands within the project area have moderate value according to the City’s Environmental Sensitivities database (City of Edmonton 2019c) ([Figure 2-3](#) and [2-4](#)). There are small areas of habitat to the east and west of the Whitemud Drive / Fox Drive interchange and to the north and south of the Rainbow Valley Bridges, which are classified as high to extremely high value (City of Edmonton 2019c) ([Figure 2-3](#) and [2-4](#)). [Table 2-1](#) provides an overview of the environmental sensitivity classes identified, best practices when working in these areas, and the Ribbon of Green (City of Edmonton 2020d) equivalent.

Natural sensitivities in the area are regulated as per municipal, provincial, and federal legislation. Landscaped and natural trees and shrubs are subject to the City of Edmonton’s Tree Policy (City of Edmonton. 2020a). Removal of or impacts on these require coordination with Urban Forestry and/or Natural Areas Operations. The bed and shore of Whitemud Creek are owned by the Province as per the *Public Lands Act* and the water is regulated under the *Water Act*. The fish and aquatic resources are regulated by the federal *Fisheries Act*. A detailed description of the regulatory requirements is provided in [Section 5](#).

Table 2-1
Environmental Sensitivity Class

Environmental Sensitivity Class	Description of Sensitivity	Best Practices	Ribbon of Green Equivalent
Extremely high	These sites are mostly found in the River Valley, its tributary ravines, and near Big Lake. Sites are often dominated by native vegetation and have multiple ecological and physical assets and steep slopes or other physical or cultural constraints that would limit development activities. Threats due to land use or aquatic impacts to these sites are minimal.	<ul style="list-style-type: none"> Protect these areas from future development. Buffer these areas to help sustain their assets and minimize impacts due to adjacent land use. Maintain or enhance connectivity at these sites. Assess projects across the city through the development and planning process. Engage developers or residents in conservation, restoration and stewardship of these sites, to promote broader awareness and support for their conservation. 	Protection
Very high	These areas are found in the River Valley, in and near its tributary ravines, and at Big Lake. They are often dominated by native vegetation and have multiple ecological assets and/or cultural or physical	<ul style="list-style-type: none"> Protect these areas from future development. Limit land use to passive recreation and development to low impact infrastructure. 	Protection

Environmental Sensitivity Class	Description of Sensitivity	Best Practices	Ribbon of Green Equivalent
	<p>constraints, and less likely to be affected by land use or aquatic threats.</p>	<ul style="list-style-type: none"> • Buffer these areas to help sustain their assets and minimize impacts due to adjacent land use. • Engage developers or residents in conservation, restoration and stewardship of these sites, to promote broader awareness and support for their conservation. • Complete detailed evaluation to ensure appropriate planning and land use for the assets at a given site. • Explore opportunities to buffer these sites, enhance connectivity, or restore key ecological functions within the site and in adjacent sensitive sites. 	
<p>High</p>	<p>These sites are found across the city and range in size from relatively small sites to larger sites in the River Valley, Big Lake, Beaver Hills moraine and Devon Dunes areas. These sites have various combinations of ecological and physical assets and may be affected by threats. Vegetation could include some non-native vegetation communities but would mainly comprise native communities.</p> <p>In the River Valley, these sites could contain any one or a combination of ecological or physical and/or cultural or development constraints.</p>	<ul style="list-style-type: none"> • Consider conservation and protection of these sites to add to the ecological network. • Complete detailed evaluation to ensure appropriate planning and land use for the assets at a given site. • Explore opportunities to buffer these sites, enhance connectivity or restore key ecological functions within the site and in adjacent sensitive sites. 	<p>Conservation</p>
<p>Moderate</p>	<p>These sites are the most abundant type of sensitive site in the city and are distributed across the city. They support fewer assets than higher sensitivity sites and are more likely to include non-native vegetation. They are located in areas that are influenced by human land use. Larger sites lie within unique landscapes that may have limited development in the past. Such sites may contain ecological assets that are limited distribution or are easily disturbed by</p>	<ul style="list-style-type: none"> • Explore opportunities to conserve all or part of these sites during the land development or redevelopment planning process, or as part of open space planning. • Where possible, complete site-specific conservation or restoration. • Consider City-sponsored habitat enhancement and stewardship programs to enhance ecological functions. 	<p>Conservation</p> <p>Restoration/ Stewardship</p>

Environmental Sensitivity Class	Description of Sensitivity	Best Practices	Ribbon of Green Equivalent
	<p>development (e.g., sandy soils, wetlands).</p> <p>These areas often have strong restoration potential that can benefit surrounding ecological assets, as well as sustaining their own ecological value. They also often lie within connective habitat and play a role in linking other sensitive areas.</p>		

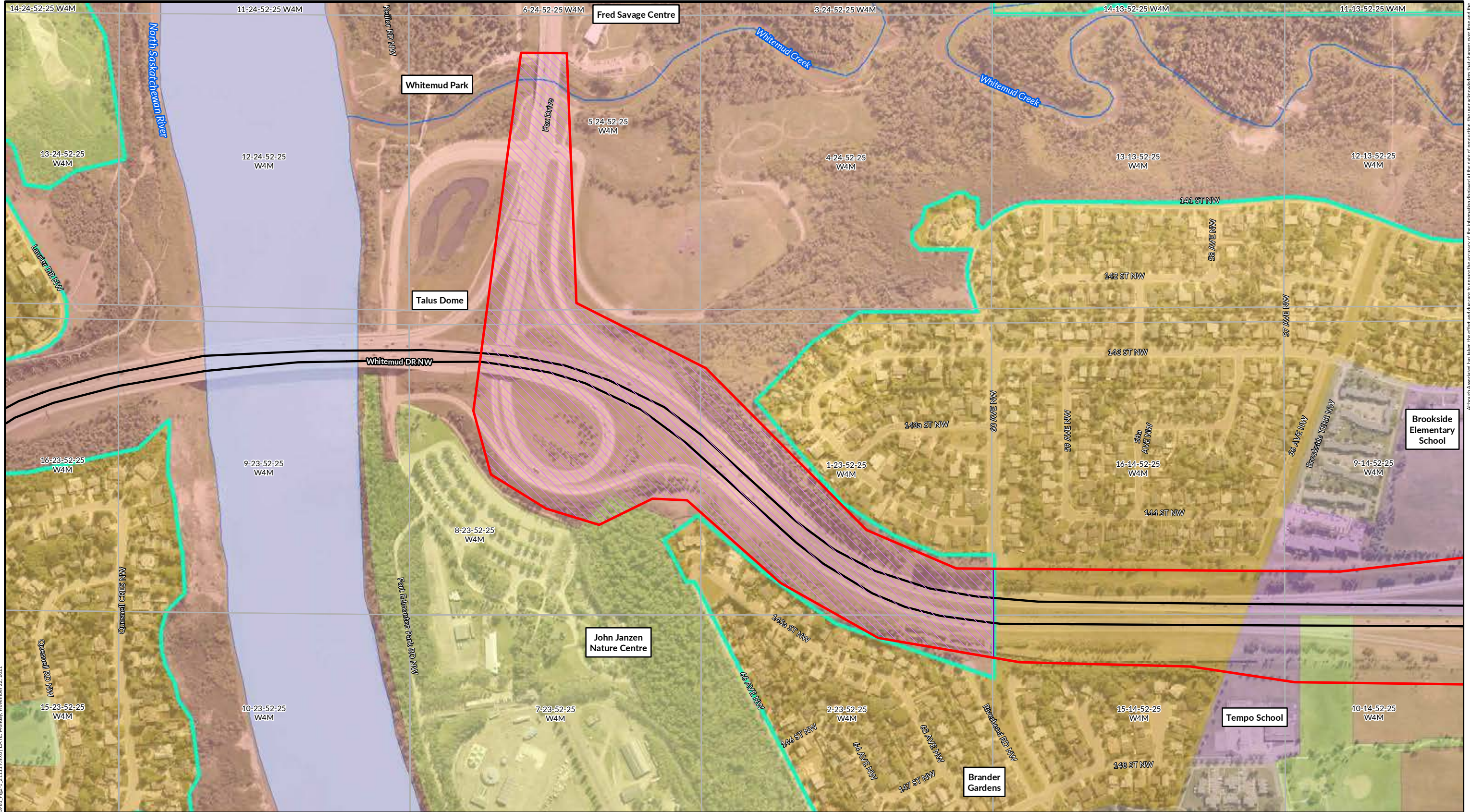

FILE: C:\Users\law\Desktop\Proj\Arch\Map\Rev\VAE\2021\9918_Fig-1_211119.mxd | DATE: Monday, November 22, 2021

Although Associated has taken the effort and expense to prepare this map, the accuracy of the information displayed is the sole responsibility of the user. The user acknowledges that changes over time and the currency of the datasets may impact the accuracy of the information without notice. Associated shall not be held liable towards the results obtained from the use of this information.



- Legend**
- Project Area
 - NSR Bylaw 7188 Area
 - Study Area
 - Water Body
 - Base Data**
 - Highway
 - Watercourse

City Of Edmonton Zoning Zone

 A	 AGU	 AJ	 AN	 AP	 RA7	 RF1	 RF5	 US
---	---	--	--	--	---	---	---	--

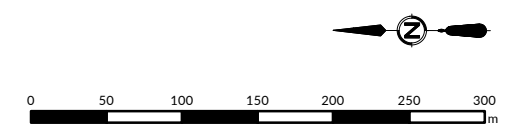

Imagery: Esri, DigitalGlobe, GeoEye, i-cubed, USDA FSA, USGS, AEX, Getmapping, Road: Statistics Canada, 2019; Hydrography: Altalis Ltd., 1996; A1S Grid: Altalis Ltd., 2005; Bylaw 7188 Area: Associated Engineering 2020; Bylaw Zones: City of Edmonton 2020.

AE PROJECT No.	2021-3981
DATE	2021 NOVEMBER
SCALE	1:5,000
COORD. SYSTEM	NAD 1983 3TM 114
REV	1
DESCRIPTION	ISSUED FOR REPORT
DRAWN BY	WL
CHECKED BY	KP

FIGURE 2-1
Project Overview And Zoning
 TWD Stage 2 Upgrades and RVB Renewal and Widening
 Fox Drive Interchange
 Environmental Impact Assessment

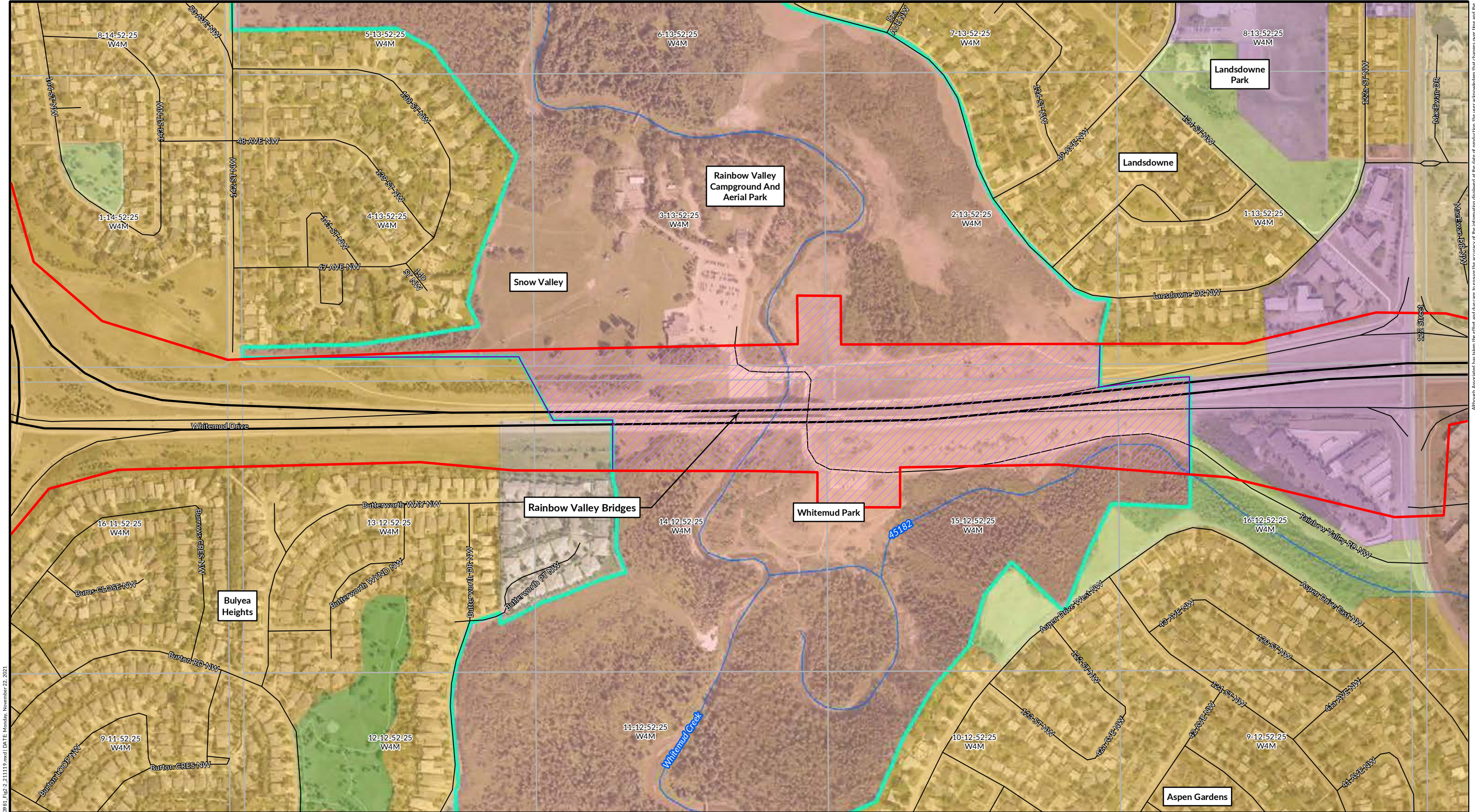

FILE: C:\Users\law\Desktop\Proj\ArchMap\Rev\VAE\2021\998L_Fig_2_211119.mxd | DATE: Monday, November 22, 2021

Although Associated has taken the effect and due care to ensure the accuracy of the information displayed on this map, the user acknowledges that changes over time and the currency of the datasets may impact the accuracy of the information without notice. Associated shall not be held liable towards the results obtained from the use of this information.



Legend

Project Area (Red outline)
 Study Area (Pink hatched)
 NSR Bylaw 7188 Area (Cyan outline)

Base Data

Highway (Black line)
 Watercourse (Blue line)

City Of Edmonton Zoning

Zone	Color
A	Light Red
AJ	Light Orange
AP	Light Green
DC2	Light Purple
PU	Light Green
RA7	Light Purple
RF1	Light Orange
RF5	Light Brown
US	Light Purple

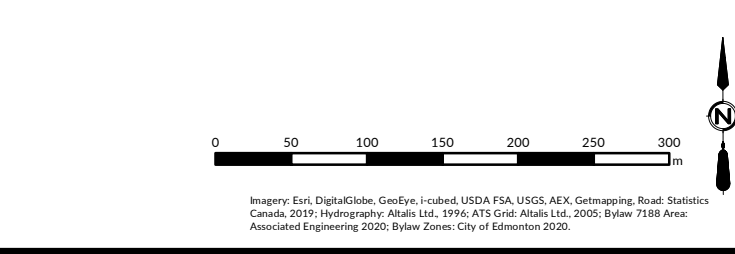

AE PROJECT No.	2021-3981
DATE	2021 NOVEMBER
SCALE	1:5,000
COORD. SYSTEM	NAD 1983 3TM 114
REV	1
DESCRIPTION	ISSUED FOR REPORT
DRAWN BY	WL
CHECKED BY	KP

FIGURE 2-2
Project Overview And Zoning

TWD Stage 2 Upgrades and RVB Renewal and Widening
 Rainbow Valley Bridges

Environmental Impact Assessment

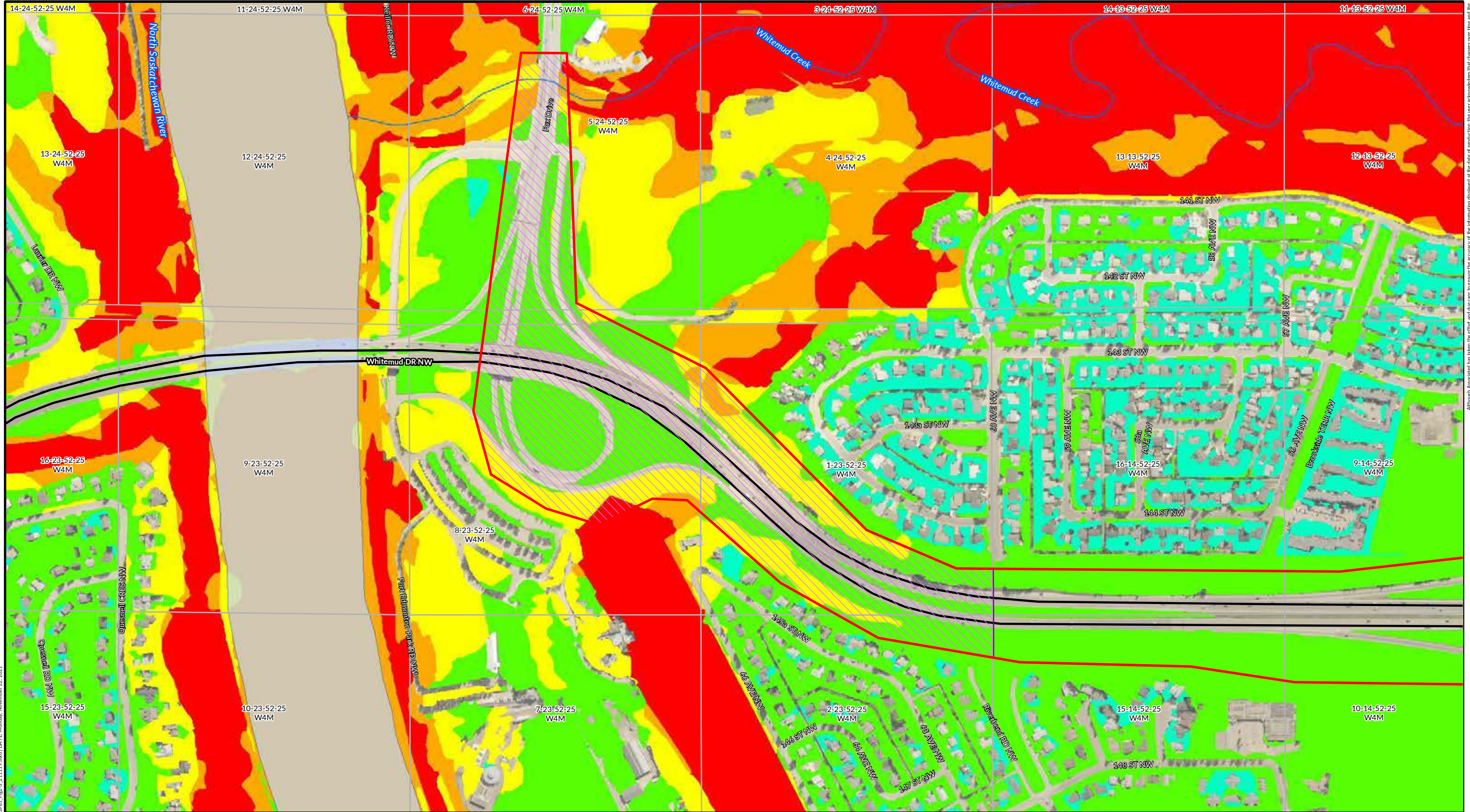

FILE: C:\Users\law\Desktop\Proj\ArcMap\Rev\VAE\2021\9981_Fig_2_211119.mxd | DATE: Monday, November 22, 2021

Although Associated has taken the effort and expense to prepare the accuracy of the information depicted in this plan of production, the user acknowledges that changes over time and the currency of the datasets may impact the accuracy of the information without notice. Associated shall not be held liable towards the results obtained from the use of this information.



Legend

Project Area	Water Body	High Value
Study Area	Environmental Sensitivity Score	Very High Value
Base Data	Low Value	Extremely High Value
Highway	Moderate Value	
Watercourse		

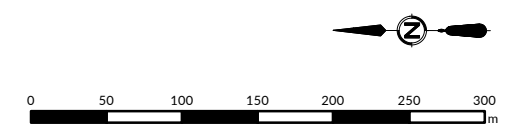

Imagery: Esri, DigitalGlobe, GeoEye, i-cubed, USDA FSA, USGS, AEX, Getmapping, Road: Statistics Canada, 2019; Hydrography: Altalis Ltd., 1996; ATIS Grid: Altalis Ltd., 2005; Environmental Sensitivity Score: City of Edmonton, 2017.

AE PROJECT No.	2021-3981
DATE	2021 NOVEMBER
SCALE	1:5,000
COORD. SYSTEM	NAD 1983 3TM 114
REV	1
DESCRIPTION	ISSUED FOR REPORT
DRAWN BY	WL
CHECKED BY	KP

FIGURE 2-3
Environmental Sensitivity Score
 TWD Stage 2 Upgrades and
 RVB Renewal and Widening
 Fox Drive Interchange
 Environmental Impact Assessment

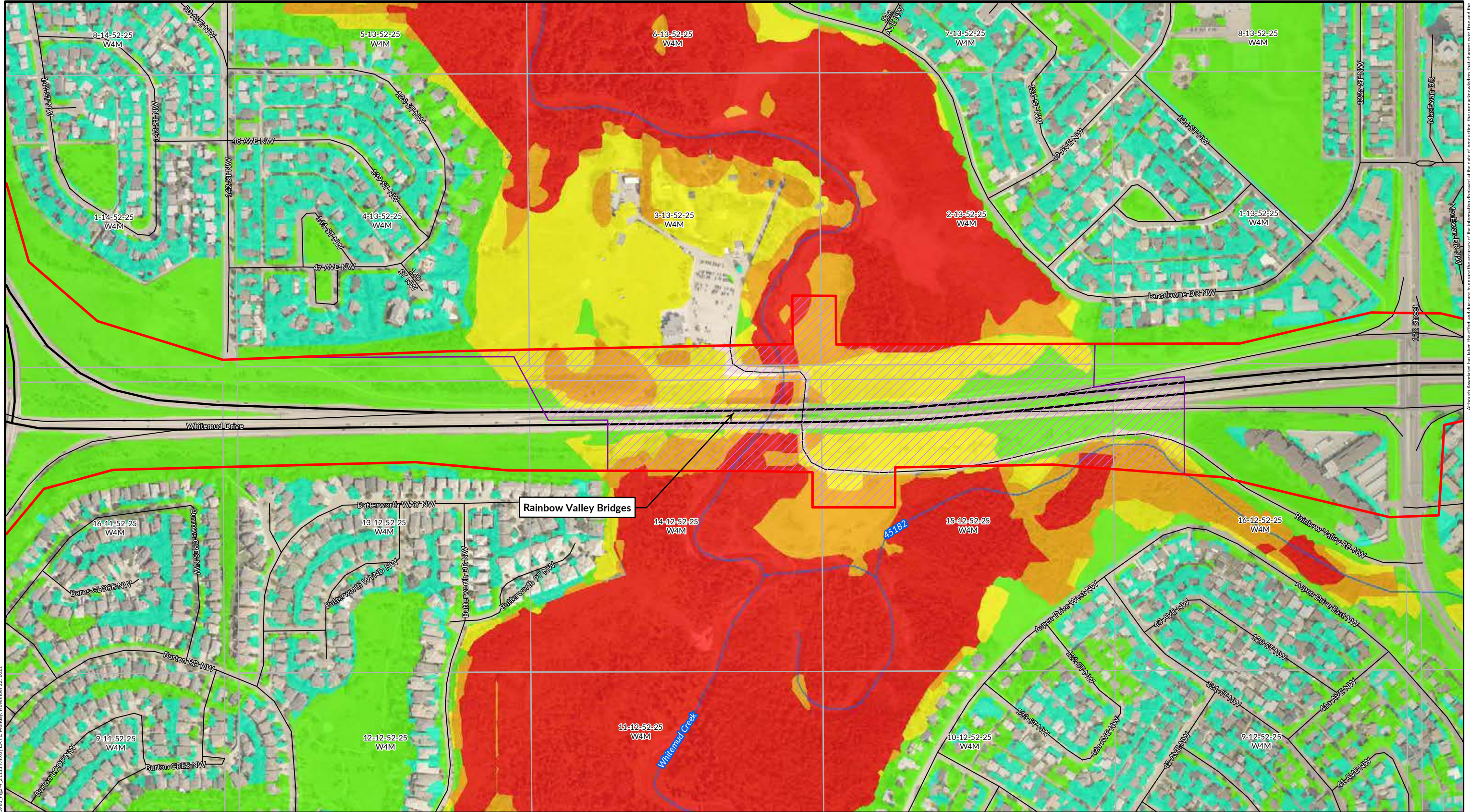

FILE: C:\Users\laur\Desktop\Proj\ArchMap\Rev\VAE\2021\9981_Fig_4_211119.mxd | DATE: Monday, November 22, 2021

Although Associated Engineering has taken the effect and due care to ensure the accuracy of the information displayed on this map, the accuracy of the data sets may impact the accuracy of the information without notice. Associated shall not be held liable towards the results obtained from the use of this information.



Legend

Project Area	Environmental Sensitivity Score Low Value	High Value
Study Area	Moderate Value	Very High Value
Highway	Extremely High Value	
Watercourse		

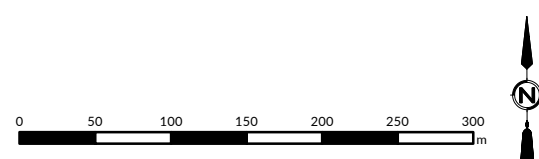

Imagery: Esri, DigitalGlobe, GeoEye, i-cubed, USDA FSA, USGS, AEX, Getmapping, Road, Statistics Canada, 2019; Hydrography: Altalis Ltd., 1996; ATIS Grid: Altalis Ltd., 2005; Environmental Sensitivity Score: City of Edmonton, 2017.

AE PROJECT No.	2021-3981
DATE	2021 NOVEMBER
SCALE	1:5,000
COORD. SYSTEM	NAD 1983 3TM 114
REV	1
DESCRIPTION	ISSUED FOR REPORT
DRAWN BY	WL
CHECKED BY	KP

FIGURE 2-4
Environmental Sensitivity Score
 TWD Stage 2 Upgrades and
 RVB Renewal and Widening
 Rainbow Valley Bridges
 Environmental Impact Assessment

3 ENVIRONMENTAL CONTEXT

Overall, the study area includes two dominant environmental features the North Saskatchewan River Valley and Whitemud Creek and its surrounding ravine. The North Saskatchewan River Valley and ravine around Whitemud Creek provide habitat to native plants and wildlife and support wildlife movement throughout the City. Whitemud Creek provides aquatic habitat for various species of fish as well as amphibians. Lands in the study area have relatively high potential to support potential archaeological and paleontological resources. In addition, soils near to the road have a high potential for salt contamination resulting from the application of road salts for ice mitigation.

3.1 Assessment Methods

3.1.1 Desktop Assessment

The assessment involved a review of publicly available data and information to identify the baseline environment and potential environmental constraints within the study area. Sources of information included:

- Significant Landforms of Alberta (Government of Alberta 2014);
- Agricultural Regions of Alberta Soil Inventory Database (AGRASID) (Government of Alberta 2021a);
- Alberta Water Well Information Database (Government of Alberta 2021b);
- Alberta Flood Hazard Map Application (Government of Alberta 2021c);
- Fisheries and Wildlife Management Information System (FWMIS) database (Government of Alberta 2021d);
- Alberta Conservation Information Management System (ACIMS) database (Government of Alberta 2019);
- Listing of Historic Resources (Government of Alberta 2021e);
- Environmental Site Assessment Repository (AEP 2020); and
- Historical Resources Overview Report ([Appendix A](#)).

3.1.2 Field Assessments

An initial field assessment was conducted by Portia Lloyd, P.Biol. of Associated on May 12, 2020. This survey identified wildlife, erosion, vegetation, and wetlands within the study area.

A general environmental field assessment was conducted by Brett Bodeux, P.Biol., and April Ziegler, P.Biol., of Associated on June 8, 2021. This survey focused on vegetation including rare plants and included incidental observations of wildlife and other notable environmental features within the study area.

A third field assessment was conducted by Erin Cawthorn, BIT, and Taylor Lowe, P.Biol., of Associated on August 26, 2021. The primary focus of this field assessment was a late-season rare plant survey.

A fourth survey was conducted by Brett Bodeux on October 19, 2021. This survey was completed in the area immediately east of Whitemud Creek and north of Rainbow Valley Bridges in an open field that may be used for construction laydown and staging. The survey focused on vegetation and potential rare plants.

The smooth concrete surfaces and lack of cracks, crevices, or ledges limit the potential for the Rainbow Valley Bridges to provide roosting or nest habitat for wildlife. Therefore, a bat survey was not conducted for this project. Habitats in the study area offer potential nesting habitat for breeding birds and it is assumed that they may support bird nests in the breeding season. Therefore, breeding bird surveys were not completed for the project as it is recognized that

appropriate surveys are needed prior to the commencement of activities with the potential to impact actively nesting birds. The study area is assumed to be used by a variety of terrestrial wildlife with the potential for ungulates to move through the area. A Wildlife Passage Engineering Design checklist (**Appendix B**) was completed to support the design of the bridge structures and it was assumed that the structures will need to accommodate for the passage of large terrestrial mammals. Therefore, wildlife tracking surveys were not completed areas as part of this Environmental Impact Assessment.

3.2 Groundwater, Surface Water, and Fish

3.2.1 Groundwater

A search of the Alberta Water Well Information Database revealed nine water wells within 500 m of the project area (Government of Alberta 2021b). Water depths in these wells range from 4.88 to 74.07 metres below ground surface (mbgs). A summary of the water wells is included in **Table 3-1**.

From the database, Well ID 75029 is reported to be a spring. Groundwater discharge may be occurring at this location. It is important to note that the database only provides approximate water well locations at the legal subdivision (LSD) scale of the ATS. Therefore, verification would be required to determine the precise location of these wells, the number of wells, and their status.

During drilling or the boreholes, groundwater seepage and soil sloughing were noted near the Rainbow Valley Bridges and at the Terwillegar Drive / Whitemud Drive interchange (Thurber 2021a,b,c). Groundwater levels range from 9.6 to 14.2 mbgs at the Rainbow Valley Bridges (Thurber 2021a), 9.4 to 29.7 mbgs at the Terwillegar Drive / Whitemud Drive interchange (Thurber 2021b), and 6.6 to 14.8 mbgs at the retaining wall locations southeast of the Terwillegar Drive / Whitemud Drive interchange (Thurber 2021c). Seasonal fluctuations in groundwater levels due to precipitation are expected. Piezometers were installed across the project area to monitor groundwater levels during design and construction.

Table 3-1
Alberta Environment and Parks Water Wells Within 500 m of the Project Area

Well ID	Approximate Distance from Project Site	Use	Date Completed or Date Report Received
75036	100 m southwest of Whitemud Drive / Fox Drive interchange	Domestic	1966-10-21
75029	On site; on Fox Drive immediately east of project area boundary	Unknown	1970-10-16
75087	300 m east of Whitemud Drive near 143 Street	Industrial	1953-08-19
79200	100 m southeast of Whitemud Drive / 122 Street interchange	Domestic & stock	Unknown
2093334	On site; on Whitemud Drive, 250 m north of Whitemud Drive / Terwillegar Drive interchange	Domestic & stock	1921-08-08
2093443	500 m northwest of Rainbow Valley Bridges	Industrial	1958-07-08
2093480	500 m northeast of Rainbow Valley Bridges	Domestic	2019-12-31

Well ID	Approximate Distance from Project Site	Use	Date Completed or Date Report Received
2096405	500 m northeast of Rainbow Valley Bridges	Chemistry	1962-07-01
2096482	500 m northeast of Rainbow Valley Bridges	Chemistry	2014-11-13

3.2.2 Surface Water

The study area occurs predominately outside of the floodway and flood fringe of the North Saskatchewan River (Government of Alberta 2021c) (Figure 3-2 and 3-3). In the northern section of the study area, at the Fox Drive / Whitemud Drive interchange, construction will occur within the flood fringe.

Topography in the study area is directed towards the North Saskatchewan River and Whitemud Creek with the highest elevations at the Terwillegar Drive / Whitemud Drive interchange. All surface water is anticipated to move towards the water bodies to the north and east of the study area. The elevation in the project area ranges from 623.5 metres above sea level (masl) to 677 masl. The lowest points in the project area are in the Whitemud Creek valley beneath the Rainbow Valley Bridges and on the east side of the Whitemud Drive / Fox Drive interchange. The highest point on the landscape is at the Whitemud Drive / Terwillegar Drive interchange. Slopes of the Whitemud Creek valley are between 4 and 5%.

The study area overlaps with Whitemud Creek at the Rainbow Valley Bridges on Whitemud Drive (Figure 3-1). Whitemud Creek conveys water north to its confluence with the North Saskatchewan River. Under the Code of Practice for Watercourse Crossings, Whitemud Creek is a Class B watercourse and has a Restricted Activity Period (RAP) of April 16 to June 30 (Government of Alberta 2012).

A portion of an unnamed tributary (ID 45182) of Whitemud Creek occurs in the study area on the south side of Whitemud Drive and east of the Rainbow Valley Bridges (Figure 3-2 and 3-3). This unnamed watercourse has the same classification (Class B) and RAP (April 16 to June 30) as Whitemud Creek (Government of Alberta 2012). Field verification revealed no evidence of a channel with no surface water present. This waterbody is likely an ephemeral drainage that is only present during heavy precipitation events.

The field assessment determined that there are no wetlands within the study area.

3.2.3 Fish

The project area is located in the yellow zone on the Whirling Disease Decontamination Risk Zone Map (Government of Alberta 2020). Whirling disease is caused by a parasite (*Myxobolus cerebralis*) that affects salmonid fish such as trout and whitefish (Government of Alberta 2021g).

The FWMIS database includes records of 19 fish species previously captured from Whitemud Creek, which are summarized in Table 3-2 (Government of Alberta 2021d). No previous fish surveys have been conducted within the unnamed tributary of Whitemud Creek. It is assumed no fish reside in the unnamed tributary due to the lack of surface water.

Fish habitat available within the study area is provided in Whitemud Creek. Whitemud Creek is a fairly straight channel at the crossing location and does not have sharp bends. The habitat within the crossing is predominantly run

with small sections of riffle (Figure 3-1). Substrates consist of fines, cobbles, and gravels. Cover is provided by turbidity, large woody debris and sections of overhanging banks. The crossing location may be used by many small-bodied fish species for foraging and spawning. It is unlikely that fish overwinter at the crossing location due to the inadequate depth of water. Large-bodied fish species may migrate through the study area, but it is unlikely they use the crossing location for spawning.



Figure 3-1
View of Whitemud Creek Looking Downstream (North)

Table 3-2
Fish Species Identified in Whitemud Creek

Common Name	Scientific Name	General Status of Alberta Wild Species ¹	Wildlife Act ²	COSEWIC ³	Species at Risk Act ⁴
Brook Stickleback	<i>Culaea inconstans</i>	Secure	N/A	N/A	N/A
Burbot	<i>Lota lota</i>	Secure	N/A	N/A	N/A
Emerald Shiner	<i>Notropis atherinoides</i>	Secure	N/A	N/A	N/A
Fathead Minnow	<i>Pimephales promelas</i>	Secure	N/A	N/A	N/A
Finescale Dace	<i>Phoxinus neogaeus</i>	Undetermined	N/A	N/A	N/A
Goldfish	<i>Carassius auratus</i>	Exotic/Alien	N/A	N/A	N/A
Lake Chub	<i>Couesius plumbeus</i>	Secure	N/A	N/A	N/A
Longnose Dace	<i>Rhinichthys cataractae</i>	Secure	N/A	N/A	N/A

Common Name	Scientific Name	General Status of Alberta Wild Species ¹	Wildlife Act ²	COSEWIC ³	Species at Risk Act ⁴
Longnose Sucker	<i>Catostomus</i>	Secure	N/A	N/A	N/A
Mountain Sucker	<i>Catostomus platyrhynchus</i>	Secure	N/A	N/A	N/A
Northern Pike	<i>Esox Lucius</i>	Secure	N/A	N/A	N/A
Pearl Dace	<i>Margariscus margarita</i>	Undetermined	N/A	N/A	N/A
River Shiner	<i>Notropis blennius</i>	Undetermined	N/A	N/A	N/A
Spottail Shiner	<i>Notropis hudsonius</i>	Secure	N/A	N/A	N/A
Threespine Stickleback	<i>Casterosteus aculeatus</i>	Exotic/Alien	N/A	N/A	N/A
Trout-perch	<i>Percopsis omiscomaycus</i>	Secure	N/A	N/A	N/A
Walleye	<i>Stizostedion vitreum</i>	Secure	N/A	N/A	N/A
White Sucker	<i>Catostomus commersoni</i>	Secure	N/A	N/A	N/A
Yellow Perch	<i>Perca flavescens</i>	Secure	N/A	N/A	N/A

¹ Government of Alberta (2017)
² Revised Statutes of Alberta 2000, Chapter W-10
³ Government of Canada (2021a)
⁴ S.C. 2002, c. 29

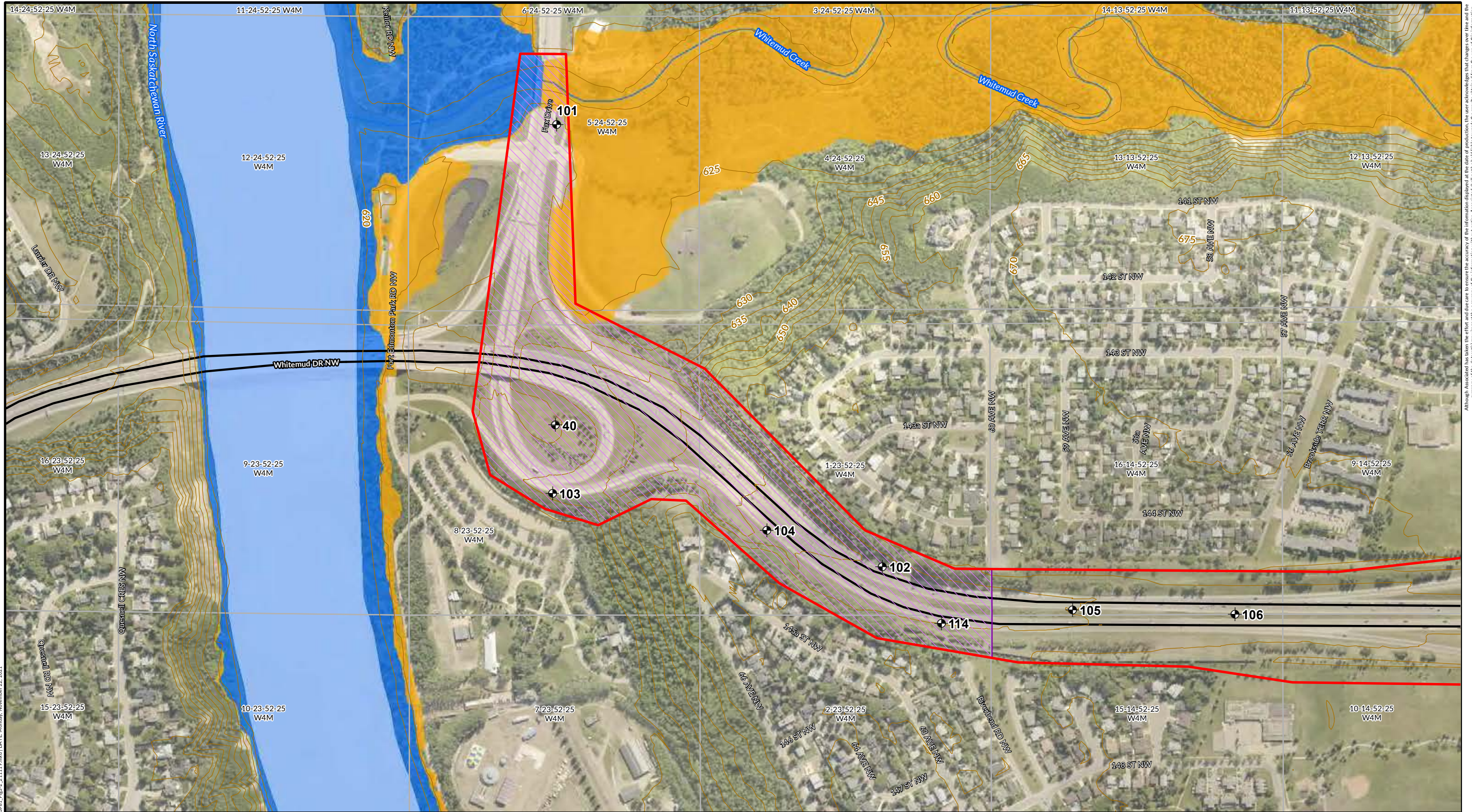

FILE: C:\Users\law\Desktop\Proj\ArcMap\Rev\VAE\2021\9981L_Fig_2_211119.mxd | DATE: Monday, November 22, 2021

Although Associated has taken the effort and expense to prepare this accuracy of the information displayed on this map. The user acknowledges that changes over time and the currency of the datasets may impact the accuracy of the information without notice. Associated shall not be held liable towards the results obtained from the use of this information.



- Legend**
- Borehole (TH21-XX)
 - Project Area
 - Study Area
 - 1 m Contour Line
 - Highway
 - Watercourse
 - Flood Fringe
 - Floodway
 - Water Body

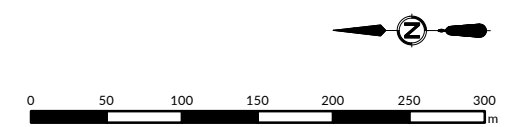

Imagery: Esri, DigitalGlobe, GeoEye, i-cubed, USDA FSA, USGS, AEX, Getmapping, Road: Statistics Canada, 2019; Hydrography: Altalis Ltd., 1996; ATIS Grid: Altalis Ltd., 2005; Contour Lines: City of Edmonton 2019; Flood Mapping: Government of Alberta, 2020.

AE PROJECT No.	2021-3981
DATE	2021 NOVEMBER
SCALE	1:5,000
COORD. SYSTEM	NAD 1983 3TM 114
REV	1
DESCRIPTION	ISSUED FOR REPORT
DRAWN BY	WL
CHECKED BY	KP

FIGURE 3-2
Groundwater, Surface Water, And Topography
 TWD Stage 2 Upgrades and RVB Renewal and Widening Fox Drive Interchange
 Environmental Impact Assessment

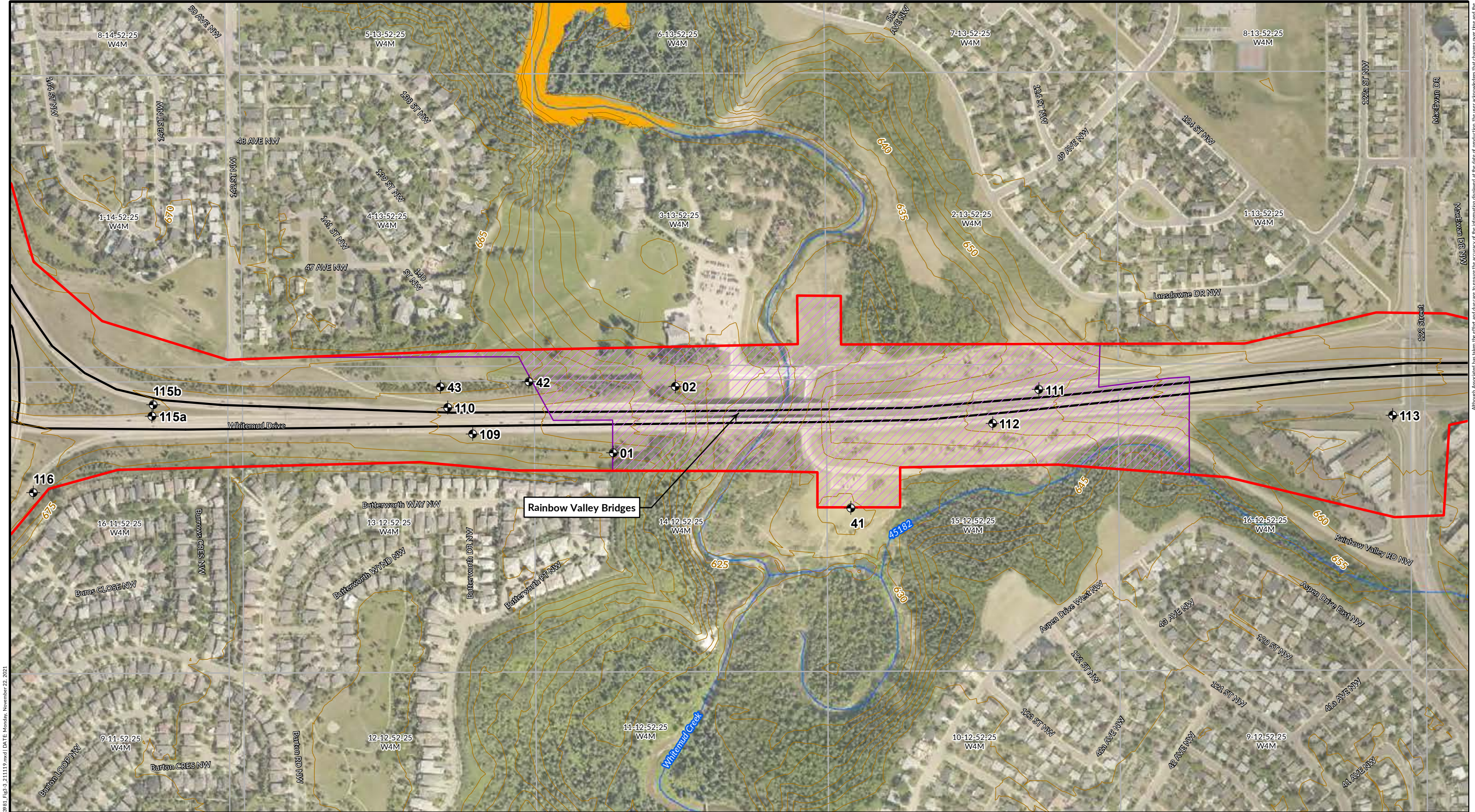

FILE: C:\Users\law\Desktop\Proj\ArchMap\Rev\VAE\2021\9981L_Figs_3_211119.mxd | DATE: Monday, November 22, 2021

Although Associated has taken the effect and date into account to prepare the information displayed on this map, the user acknowledges that changes over time and the accuracy of the datasets may impact the accuracy of the information without notice. Associated shall not be held liable towards the results obtained from the use of this information.



Legend	
	Borehole (TH21-XX)
	Project Area
	Study Area
Base Data	
	Highway
	Watercourse
	Flood Fringe
	Floodway
	1 m Contour Line

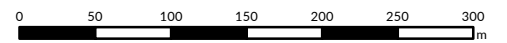

AE PROJECT No.	2021-3981
DATE	2021 NOVEMBER
SCALE	1:5,000
COORD. SYSTEM	NAD 1983 3TM 114
REV	1
DESCRIPTION	ISSUED FOR REPORT
DRAWN BY	WL
CHECKED BY	KP

FIGURE 3-3
Groundwater, Surface Water, And Topography
 TWD Stage 2 Upgrades and RVB Renewal and Widening Rainbow Valley Bridges
 Environmental Impact Assessment

3.3 Geomorphology, Geology, and Soils

The project area is located in the Central Parkland Natural Subregion where the dominant landform is undulating glacial till plains, with approximately 30% hummocky, rolling and undulating uplands (Natural Regions Committee 2006). Surficial materials are dominantly medium to moderately fine-textured, moderately calcareous glacial till that may be a thin (less than 2 m) blanket over bedrock in some of the low-relief plains (Natural Regions Committee 2006). Bedrock formations underlying the project area are tertiary sandstones and mudstones (Natural Regions Committee 2006). There is a significant component (10%) of glaciofluvial sands and organic deposits but only minor inclusions of glaciolacustrine materials (Natural Regions Committee 2006).

The project is not located within an area designated as a significant landform element by the Government of Alberta (2014). The significant landforms of Alberta project was initiated to record the geomorphic features of the province.

The bedrock geology of the project area consists of sandstone interbedded with siltstones, mudstones, and coal seams of the Upper Cretaceous Horseshoe Canyon Formation (Prior et al. 2013).

Surficial geology primarily consists of glaciolacustrine deposits (i.e. sediments associated with former glacial lakes) that range from massive fine-grained sand, silt and clay for offshore sediments, to silty or pebbly sand with gravel for nearshore sediments (Fenton et al. 2013). The glaciolacustrine deposits overlie glacial till, consisting of mixed clay, silt, sand, gravel, and boulders. The glaciolacustrine deposits have been eroded by Whitemud Creek and the North Saskatchewan River, and reach approximately 9 metres in thickness near Terwillegar Drive and 122 Street interchanges (Andriashek and MacMillan 1981, Kathol and McPherson 1975).

Surficial deposits within Whitemud Creek consist of gravel, sand, silt and clay alluvium (i.e., deposited by streams), and surficial deposits within the North Saskatchewan River consists of gravel, sand and silt alluvium. Both the Whitemud Creek and North Saskatchewan River valley slopes consist of colluvial sediments (i.e., displaced by gravity) from stream alluvium, and mixed glacial and bedrock materials. No evidence of water body erosion was identified.

Detailed information on the geology and geomorphology pertaining to the project is provided in the geotechnical investigations completed by Thurber Engineering Ltd. ([Appendix C](#)). These reports indicate that the general stratigraphy in the area consists of clay fill underlain by glaciolacustrine clay, sand, silt and clay layers, clay till, and clay shale and sandstone.

The project area is located in Soil Correlation Area 10 (Pedocan Land Evaluation Ltd. 1993), within the Thick Black Soil Zone of central Alberta. The Agricultural Region of Alberta Soil Inventory Database (AGRASID) identifies soils in the area as miscellaneous undifferentiated mineral soils (Government of Alberta 2021a). Most of the soils in the project area are likely disturbed and consist of fill material given the extent of previous development and anthropogenic disturbance. Soils with naturally developed profiles likely occur in the undisturbed areas associated with the North Saskatchewan River Valley and Ravine System around the Rainbow Valley Bridges.

3.4 Vegetation

3.4.1 General Vegetation

Much of the study area is developed roads and paths ([Figures 3-4](#) and [3-5](#)). The Urban Primary Land Vegetation Inventory (City of Edmonton 2016b) reveals that the dominant vegetated site types in the study area are non-maintained grass and shrubs and maintained grass occurring adjacent to the roads and within the rights-of-way

(Figures 3-4 and 3-5). Modifications to the Urban Primary Land Vegetation Inventory, based on a combination of fine scale mapping and field observations, show that there are 10 polygons of forested site types and three polygons of medial shrub site types within the study area (Figures 3-4 and 3-5). The dominant tree types of the sections of the forested polygons within the study area are shown on Figures 3-4 and 3-5. At the Whitemud Drive / Fox Drive interchange, there is an area of medial shrub dominated by caragana (*Caragana arborescens*) west of the loop and the areas of non-maintained grass and shrubs in the middle of the loop contain scattered coniferous trees. Additionally, there are scattered trees within the non-maintained grass and shrubs polygons to the north and south of Whitemud Drive and east of the Rainbow Valley Bridges. Outside of the study area, there are many trees adjacent to the roadways and inside of the interchange loops.

Tree species in the canopy of deciduous-dominated forested areas primarily consist of trembling aspen (*Populus tremuloides*) and balsam poplar (*Populus balsamifera*). Typically, the understorey of these forested areas is dense with shrub species including beaked hazelnut (*Corylus cornuta*), choke cherry (*Prunus virginiana*), prickly rose (*Rosa acicularis*), red-osier dogwood (*Cornus stolonifera*), saskatoon (*Amelanchier alnifolia*), and snowberry (*Symphoricarpos albus*). Common forbs to these forested areas include northern bedstraw (*Galium boreale*), star-flowered Solomon's seal (*Maianthemum stellatum*), low goldenrod (*Solidago missouriensis*), wild lily-of-the-valley (*Maianthemum canadense*), and wild sarsaparilla (*Aralia nudicaulis*).

Tree species in the canopy of mixedwood forested areas consist of a mixture of trembling aspen, balsam poplar, and white spruce (*Picea glauca*). The portions of mixedwood forested areas that overlap with the study area consist mainly of deciduous trees, and the understorey composition is similar to the deciduous-dominated forested areas.

The dominant tree species in the coniferous forested area southeast of the Fox Drive interchange is white spruce. Generally, the understorey of the coniferous forested area is less dense compared to the other forested areas. Common understorey shrub species include prickly rose, red-osier dogwood, and saskatoon. Forbs that are common to the coniferous forested area include common fireweed (*Chamerion angustifolium*), common horsetail (*Equisetum arvense*), showy aster (*Eurybia conspicua*), and star-flowered Solomon's seal.

3.4.2 Rare Plants

The ACIMS database has records of several non-sensitive elemental occurrences documented within 2 km of the study area. A summary of element occurrences is presented in Table 3-1. The element occurrences within and adjacent to the study area are shown on Figure 3-4 and 3-5. These species have been assigned subnational status ranks that indicate they are uncommon and of conservation concern or lacking information to adequately determine their status in Alberta. None of the species are listed under the provincial *Wildlife Act* or the federal *Species at Risk Act* (SARA) or tracked by the Committee on the Status of Endangered Wildlife in Canada (COSEWIC).

No rare plants were observed during the early and late season rare plant surveys. The vegetation survey of the proposed laydown/staging area to the northeast of Rainbow Valley Bridges revealed the area to be an open field dominated by disturbance adapted/tolerant and exotic vegetation species and regulated weeds. Canada thistle is the most abundant of the regulated weeds but there are also occurrences of scentless chamomile, and common tansy. Overall, there is low rare plant potential in most of this area; however, on the edges near to Whitemud Creek and the forest stand to the east there are more native plant species and higher potential for rare plants.

**Table 3-3
Elemental Occurrences Within 2km of the Project Area**

Common Name	Scientific Name	Location (Sec-52-25 W4M)	ACIMS Subnational Status Rank ¹	Preferred Habitat
Blunt-leaved hair moss	<i>Didymodon tophaceus</i>	24	S2S3	Hard substrates including limestone, limy shale, dolomite, cliffs, and rock in moist area such as seepage and waterfalls or moist clay (Flora of North America Association 2014).
Dot lichen	<i>Micarea melaena</i>	13	S1	Wood of conifer snags and logs in humid forests at lower to middle elevations (Björk and Goward 2010).
Flat fruited pelt lichen	<i>Peltigera horizontalis</i>	12, 13	S2S4	Mossy soil, logs, and rocks in forests (Goward et al. 1994).
Flat-topped white aster	<i>Doellingeria umbellata</i> var. <i>pubens</i>	12	S3	Part shade, part sun in moist fields, edges of woods, bogs and swamps (Minnesota Wildflowers 2021).
Lichen	<i>Pseudevernia consocians</i>	13	S2	Bark in wet northern forests such as black spruce wetlands (Wisconsin Department of Natural Resources 2021).
Moss	<i>Ptychostomum cernuum</i>	24	S1S2	Wet soils associated with streams, wetlands, and calcareous habitats (Flora of North America Association 2014).
Ontario Rhodobryum moss	<i>Rhodobryum ontariense</i>	12, 24	S1S2	Moist ground in woodlands, wooded hillsides, thin soil over sandstone rocks in wooded areas, shaded ground in hanging fens, and sandy clay banks along creeks (Hilty 2020).
Schleicher's silk moss	<i>Entodon schleicheri</i>	13	S2S3	Rock and bark and bases of trees (Flora of North America Association 2020).
Smooth sweet cicely	<i>Osmorhiza longistylis</i>	12	S3	Moist to medic deciduous woodlands and gentle slopes of wooded ravines (Hilty 2020).

3.4.3 Regulated Weeds

Patches of creeping thistle (*Cirsium arvense*), perennial sow-thistle (*Sonchus arvensis*), scentless chamomile (*Tripleurospermum inodorum*), and white cockle (*Silene latifolia*) occur throughout the study area. These species are listed as noxious and are regulated under the Alberta *Weed Control Regulation* (Alberta Reg. 19/2010) of the *Weed Control Act* (S.A. 2008, c. W-5.1). Creeping thistle and perennial sow-thistle are the most prevalent weeds in the study area whereas scentless chamomile and white cockle are less widely distributed. Infestations of these weeds are most frequent adjacent to existing infrastructure where previous disturbance has occurred.



FILE: C:\Users\law\Desktop\Proj\ArcMap\Rev\VAE\2021\981L_Fig_4_211119.mxd | DATE: Monday, November 22, 2021

Although Associated has taken the effort and expense to prepare this accuracy of the information displayed on this map. The user acknowledges that the user will use the information at their own risk. Associated shall not be held liable towards the results obtained from the use of this information.



Legend	
	Project Area
	Study Area
Base Data	
	Highway
	Watercourse
	Non-Sensitive ACIMS Occurrence
	Water Body
Urban Primary Land Vegetation Inventory	
Type	
	Closed Shrub
	Farmyard/Acreage
	Forested
	Maintained Grass
	Medial Shrub
	Non maintained Grass/Shrubs
	Tame Pasture
	Transplant Trees
	Annual Crops

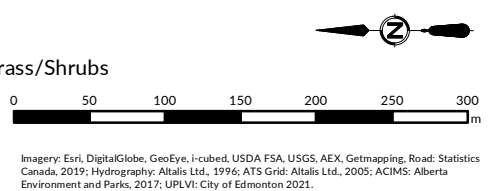

Imagery: Esri, DigitalGlobe, GeoEye, i-cubed, USDA FSA, USGS, AEX, Getmapping, Road Statistics Canada, 2019; Hydrography: Altalis Ltd., 1996; ATIS Grid: Altalis Ltd., 2005; ACIMS: Alberta Environment and Parks, 2017; UPLV: City of Edmonton 2021.

AE PROJECT No.	2021-3981
DATE	2021 NOVEMBER
SCALE	1:5,000
COORD. SYSTEM	NAD 1983 3TM 114
REV	1
DESCRIPTION	ISSUED FOR REPORT
DRAWN BY	WL
CHECKED BY	KP

FIGURE 3-4
Vegetation
TWD Stage 2 Upgrades and RVB Renewal and Widening Fox Drive Interchange
Environmental Impact Assessment

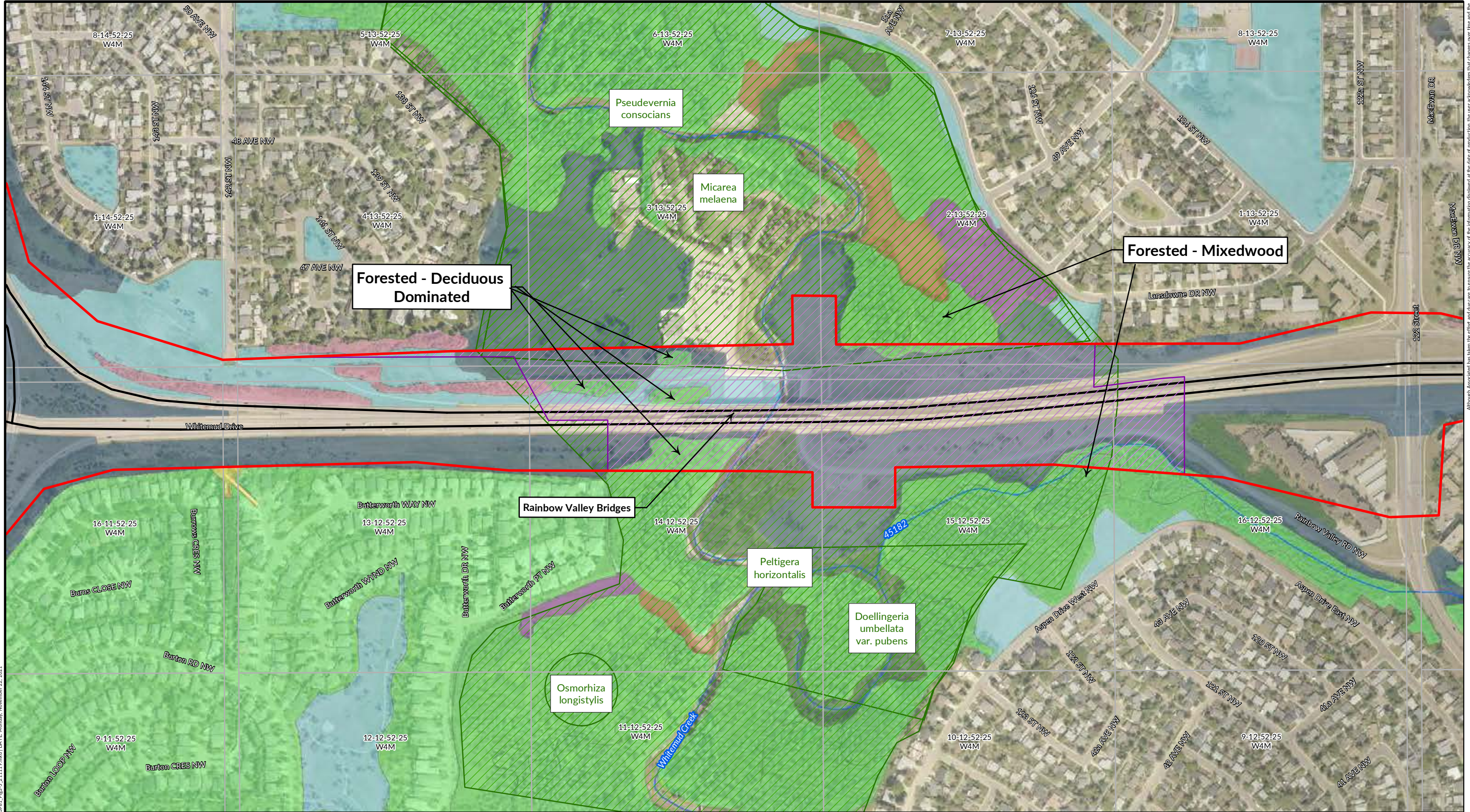

FILE: C:\Users\law\Desktop\Proj\ArcMap\RevA\AE\2021\981L_Fig_5_2_11119.mxd | DATE: Monday, November 22, 2021

Although Associated has taken the effort and care to ensure the accuracy of the information displayed on this map, the user acknowledges that changes over time and the currency of the datasets may impact the accuracy of the information without notice. Associated shall not be held liable towards the results obtained from the use of this information.



Legend

Project Area	Non-Sensitive ACIMS Occurrence	Herbaceous Grass	Non maintained Grass/Shrubs
Study Area	Urban Primary Land Vegetation Inventory	Maintained Grass	Transplant Trees
Base Data	Type	Maintained Trails	
Highway	Closed Shrub	Forested	
Watercourse		Medial Shrub	

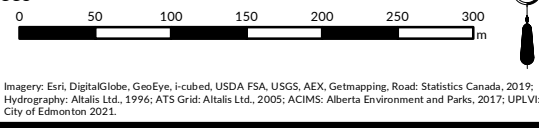

AE PROJECT No.	2021-3981
DATE	2021 NOVEMBER
SCALE	1:5,000
COORD. SYSTEM	NAD 1983 3TM 114
REV	1
DESCRIPTION	ISSUED FOR REPORT
DRAWN BY	WL
CHECKED BY	KP

FIGURE 3-5
Vegetation
 TWD Stage 2 Upgrades and
 RVB Renewal and Widening
 Rainbow Valley Bridges
 Environmental Impact Assessment

3.5 Wildlife

3.5.1 Wildlife Zones

The project area occurs in the B4 Nesting Zone where the general bird nesting period is from mid-April to late August (Government of Canada 2018). Migratory bird nesting potential is highest in the forested medial shrub and non-maintained grass/shrubs vegetation site types and along the banks of Whitemud Creek. However, migratory birds may nest in vegetation within other site types or on manmade structures such as bridges and buildings.

Some non-migratory birds, such as owls, may begin nesting as early as mid-February. Although there is no wildlife zone or nesting period specific to owls, the ranges of several species including barred owl (*Strix varia*), great-horned owl (*Bubo virginianus*), and northern saw-whet owl (*Aegolius acadicus*) overlap with the study area. Individuals of these species have potential to nest in trees and forested habitats of the study area.

Wildlife Sensitivity Maps show that the study area is located within the Sensitive Raptor Range for bald eagle (*Haliaeetus leucocephalus*) and the known range of sharp-tailed grouse (*Tympanuchus phasianellus*) (Government of Alberta 2021f; **Figure 3-6** and **3-7**). Although bald eagles' nest in forested areas near large bodies of water, such as rivers and lakes, they typically avoid heavily developed areas (Cornell University 2019). Sharp-tailed grouse leks typically occur in open areas with short, sparse vegetation within landscapes dominated by agricultural production (Stavne 2006). Given the habitat requirements and the urban setting, the presence of sharp-tailed grouse leks within or near to the study area is unlikely.

The study area is also located in a Key Wildlife Biodiversity Zone corresponding with the North Saskatchewan River and Whitemud Creek valleys (**Figure 3-6** and **3-7**), as these landforms contain topographic variation and vegetation productivity that increase biodiversity and provide important winter browse conditions for ungulates (Government of Alberta 2015). Timing restrictions can apply to activities occurring in this zone; however, these are focused on industrial activities and may be adjusted in localized situations if other considerations are applied that still protect the wildlife resource. Generally, construction activities within Key Wildlife Biodiversity Zones should be minimized between January 15 and April 30 to avoid the displacement of ungulates (Government of Alberta 2015).

3.5.2 Wildlife Corridors and Movement

The North Saskatchewan River Valley provides a linkage within the regional biological corridor (City of Edmonton 2021b). Whitemud Creek is a biodiversity core area identified on the City's Ecological Network Map (City of Edmonton 2021b). Whitemud Creek provides a wildlife corridor between the North Saskatchewan River valley and Blackmud Creek.

The forested and medial shrub habitats adjacent to the northwest portion of the Whitemud Drive/Fox Drive interchange are recognized as terrestrial winter pinch points for terrestrial wildlife (**Figure 3-6**; City of Edmonton 2019c). Areas surrounding the Rainbow Valley Bridges and Whitemud Creek are recognized as summer and winter pinch points for terrestrial wildlife (**Figure 3-7**; City of Edmonton 2019c). Habitats in these areas offer cover and connectivity that supports terrestrial wildlife movement through the North Saskatchewan River Valley and Ravine System.

At Rainbow Valley Bridges, there are four open spaces between abutments and piers beneath the existing structures. The cross-sectional area of these spaces from east to west is approximately 350 m², 740 m², 620 m², 290 m². The total width of the eastbound and westbound bridges, including the 4.4 m gap between them, is 36 m, which corresponds to

the length of wildlife passage. Therefore, openness ratios of the four open spaces beneath the existing bridges are 9.7, 20.6, 17.2, and 8.2, from east to west, respectively. These openness ratios are well above the minimum ratio of 1.5 that is required for large terrestrial mammals (City of Edmonton 2010).

There are trails in forested and medial shrub vegetated areas to the east and west of the Whitemud Drive/Fox Drive interchange (Figure 3-6). These trails appear to be frequented by humans and are likely used by terrestrial wildlife as well. Deer droppings observed adjacent to the trail to the southeast of the Whitemud Drive/Fox Drive interchange suggest deer travel on the trail. In addition, there is a trail in the vegetated area along the east side of Whitemud Creek that is likely frequented by terrestrial mammals (Figure 3-7). Deer tracks crossing beneath the Rainbow Valley Bridges were observed in the open space between the two sets of piers on the west side of Whitemud Creek as well as the open space between the western most pier and abutment.

To the north of the Rainbow Valley Bridges, a bridge takes Rainbow Valley Road NW over Whitemud Creek to the Snow Valley Ski Club. There is limited space beneath this bridge as well as extensive riprap that likely limits the potential for wildlife movement along the Whitemud Creek.

3.5.3 Wildlife Observations

Detailed data from the Fish and Wildlife Management Information System (FWMIS) revealed that 43 wildlife species have been documented within Sections 11 through 14, 23, and 24 of 052-25 W4M (Government of Alberta 2021d). Seven of these are species of conservation concern with some protected under the provincial *Wildlife Act* and/or the federal *Species at Risk Act* (Table 3-4). Nest sites of barred owl (*Strix varia*), cedar waxwing (*Bombycilla cedrorum*), clay-coloured sparrow (*Spizella pallida*), gadwall (*Anas strepera*), and peregrine falcon (*Falco peregrinus*) have been documented in the area (Government of Alberta 2021d). Nest sites of barred owl and peregrine falcon were located outside of the study area. The barred owl nest site was located adjacent to Whitemud Creek, within the North Saskatchewan River Valley and Ravine System Protection Overlay. The peregrine falcon nest site was located to the northwest of the study area along the North Saskatchewan River. Two of the previously documented migratory bird nests including the cedar waxwing and clay-coloured sparrow occurred within a non-maintained grass/shrubs site within the study area. The gadwall nest site was located outside of the study area within the North Saskatchewan River Valley and Ravine System Protection Overlay, associated with Whitemud Creek.

Incidental observations of birds in the study area included chipping sparrow (*Spizella passerina*), black-capped chickadee (*Poecile atricapillus*), clay-coloured sparrow, yellow warbler (*Setophaga petechia*), cedar waxwing, song sparrow (*Melospiza melodia*), American crow (*Corvus brachyrhynchos*), gray catbird (*Dumetella carolinensis*), Canada goose (*Branta canadensis*), common goldeneye (*Bucephala clangula*), hooded merganser (*Lophodytes cucullatus*), and red-eyed vireo (*Vireo olivaceus*). Wildlife features including inactive stick nests, trails, red squirrel drey, beaver felled trees, and wildlife trees were observed within the study area (Figure 3-6 and 3-7).

**Table 3-4
Wildlife Species of Conservation Concern Previously Recorded Within or Near the Study Area**

Common Name / Scientific Name	General Status of Alberta Wild Species ¹	Wildlife Act ²	Species at Risk Act ³	COSEWIC ⁴	Habitat Requirements	Habitat Presence in Study Area
Amphibians						
Canadian Toad (<i>Anaxyrus hemiophrys</i>)	May be at Risk	N/A	Not at Risk	Not at Risk	Breeding habitat includes shallows of lakes, ponds, ditches, marshes and other temporary bodies of water (Russell and Bauer 2000).	Low to moderate potential to occur within riparian areas of Whitemud Creek.
Northern Leopard Frog (<i>Lithobates pipiens</i>)	At Risk	Threatened	Special Concern	Special Concern	Breeding habitat includes water bodies with shallow standing water, lacking fish, and containing abundant aquatic vegetation. These water bodies may include ponds, marshes, oxbows of rivers, beaver ponds, backwaters of flowing watercourses, irrigation ditches, dugouts, lake margins, or reservoirs. (Government of Alberta. 2007).	Low potential as the range of this species has been dramatically reduced and it is thought to be absent from central Alberta (Government of Alberta. 2007).
Birds						
Barred Owl (<i>Strix varia</i>)	Sensitive	Special Concern	N/A	N/A	Mixed forests with large trees and often near water (Cornell Lab of Ornithology 2019b).	Moderate to high potential to occur in forested site types within the North Saskatchewan River Valley and Ravine System Protection Overlay.

Common Name / Scientific Name	General Status of Alberta Wild Species ¹	Wildlife Act ²	Species at Risk Act ³	COSEWIC ⁴	Habitat Requirements	Habitat Presence in Study Area
Olive-sided flycatcher (<i>Contopus cooperi</i>)	May be at Risk	May be at Risk	Threatened	Special Concern	Nest in openings or edges in forested areas often near meadows, rivers and streams, partially logged areas, recent burns, beaver ponds, bogs, and muskegs (Cornell Lab of Ornithology 2019c).	Moderate potential to occur near forested site types within the North Saskatchewan River Valley and Ravine System Protection Overlay.
Peregrine Falcon (<i>Falco peregrinus</i>)	At Risk	Threatened	Special Concern	Not at Risk	Nest on buildings and other manmade structures, and on cliffs in natural areas (Cornell Lab of Ornithology 2019d).	Low potential as buildings of suitable size or cliffs are not located in the study area.
Pileated Woodpecker (<i>Dryocopus pileatus</i>)	Sensitive	N/A	N/A	N/A	Mature deciduous or mixed wood forests. and nest in tree cavities, often in dead trees (Cornell Lab of Ornithology 2019e).	Moderate to high potential to occur in forested site types within the North Saskatchewan River Valley and Ravine System Protection Overlay.
Short-eared Owl (<i>Asio flammeus</i>)	May Be at Risk	N/A	Special Concern	Special Concern	Nest on the ground in large, open areas with low vegetation, including prairie grasslands, meadows, marshes, and agricultural areas (Cornell Lab of Ornithology 2019f).	Low potential to occur within the study area given the lack of open grassland and marshes as well as the surrounding urban landscape.



FILE: C:\Users\law\Desktop\Proj\ArchMap\Rev1\AE\2021\981L_Fig_6_211119.mxd | DATE: Monday, November 22, 2021

Although Associated has taken the effort and expense to prepare this accuracy of the information displayed in this atlas of products. We are not responsible for the accuracy of the information. Associated shall not be held liable towards the results obtained from the use of this information.



Legend

- Wildlife Observation
- Existing Trail (Approximate Location)
- Project Area
- Study Area

Base Data

- Highway
- Watercourse
- Key Wildlife and Biodiversity Zone

- Terrestrial Pinch Point (Summer)
- Terrestrial Pinch Point (Winter)
- Water Body

Entire Project Area Is Within Sensitive Raptor Zone and Sharp-tailed Grouse Zone.

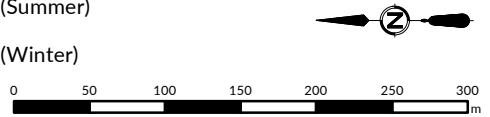

Imagery: Esri, DigitalGlobe, GeoEye, i-cubed, USDA FSA, USGS, AEX, Getmapping, Road: Statistics Canada, 2019; Hydrography: Altalis Ltd., 1996; ATIS Grid: Altalis Ltd., 2005; Wildlife Sensitivity: Government of Alberta, 2018; Pinch Points: City of Edmonton, 2017.

AE PROJECT No.	2021-3981
DATE	2021 NOVEMBER
SCALE	1:5,000
COORD. SYSTEM	NAD 1983 3TM 114
REV	1
DESCRIPTION	ISSUED FOR REPORT
DRAWN BY	WL
CHECKED BY	KP

FIGURE 3-6 Wildlife

TWD Stage 2 Upgrades and RVB Renewal and Widening
 Fox Drive Interchange
 Environmental Impact Assessment

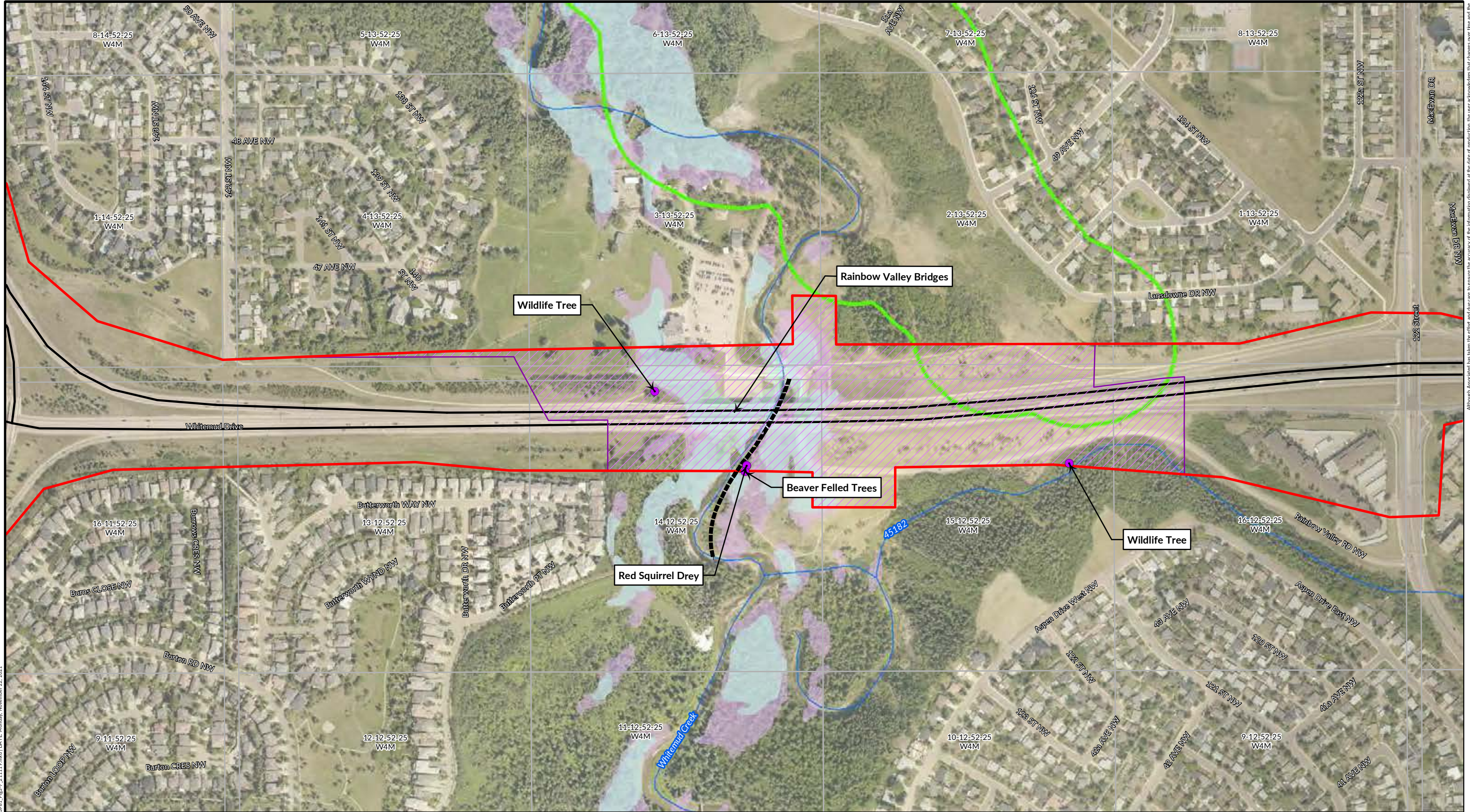

FILE: C:\Users\law\Desktop\Proj\ArchMap\Rev\VAE2021\981L_Fig3-7_211119.mxd | DATE: Monday, November 22, 2021

Although Associated has taken the effort and care to ensure the accuracy of the information displayed on this site, the user acknowledges that changes over time and the currency of the datasets may impact the accuracy of the information without notice. Associated shall not be held liable towards the results obtained from the use of this information.



Legend

- Wildlife Observation
- Existing Trail (Approximate Location)
- Project Area
- Study Area

Base Data

- Highway
- Watercourse
- Key Wildlife and Biodiversity Zone

- Terrestrial Pinch Point (Summer)
- Terrestrial Pinch Point (Winter)
- Water Body

Entire Project Area Is Within Sensitive Raptor Zone and Sharp-tailed Grouse Zone.

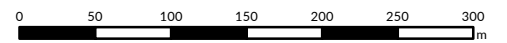

AE PROJECT No.	2021-3981
DATE	2021 NOVEMBER
SCALE	1:5,000
COORD. SYSTEM	NAD 1983 3TM 114
REV	1
DESCRIPTION	ISSUED FOR REPORT
DRAWN BY	WL
CHECKED BY	KP

FIGURE 3-7
Wildlife
 TWD Stage 2 Upgrades and RVB Renewal and Widening
 Rainbow Valley Bridges
 Environmental Impact Assessment

3.6 Historical Resources

A Historical Resources Overview has been completed for the project and is included in **Appendix A**. Lands in the project area have been assigned the following Historic Resource Values (HRVs) (**Figure 3-8** and **3-9**):

- 4 for palaeontology;
- 5 for archaeology; and
- 5 for palaeontology.

Archaeology sites do not occur within the project area; however, there are 16 known archaeological sites within 1 km of the project area. Three of these sites are significant HRV 4 sites and occur within 300 m of the project area.

A *Historical Resources Act* Approval (# 4715-21-0020-001) for the project was received on April 22, 2021 (**Appendix A**). This Approval contained a condition requiring the completion of a Historic Resources Impact Assessment for palaeontological resources. To satisfy this condition, a Historical Resources Impact Assessment Report for palaeontological resources (**Appendix A**) was completed, which recommends palaeontological monitoring in areas of significant ground disturbance.

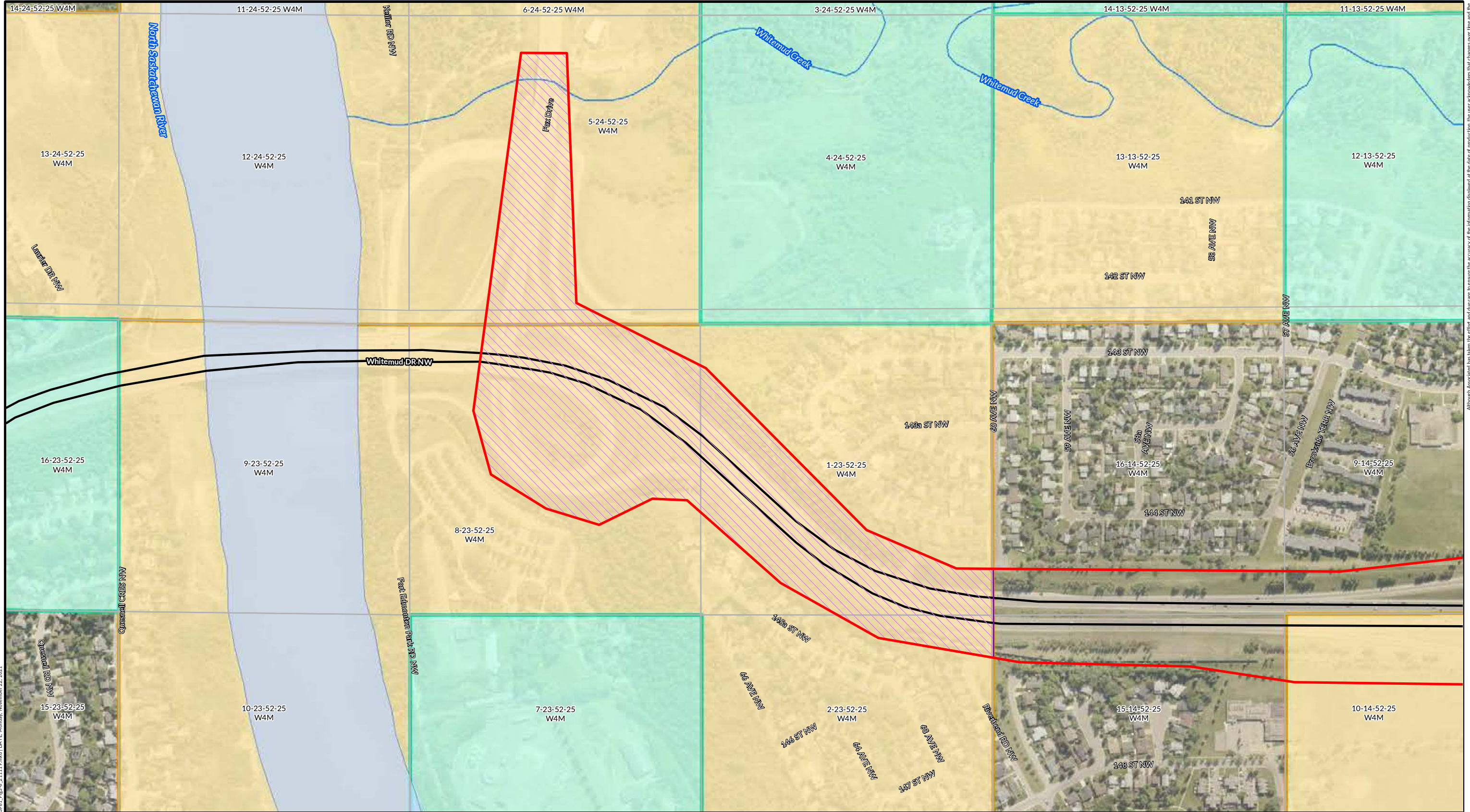

FILE: C:\Users\law\Desktop\Proj\ArchMap\RevA\AE\2021\998L_Figs_B_211119.mxd | DATE: Monday, November 22, 2021

Although Associated has taken the effort and expense to prepare the accuracy of this information, it is not a warranty, and the user acknowledges that changes over time and the currency of the datasets may impact the accuracy of the information without notice. Associated shall not be held liable towards the results obtained from the use of this information.



Legend	
	Project Area
	Study Area
	Watercourse
	HRV 4
	HRV 5
	Water Body
	Highway
Base Data	

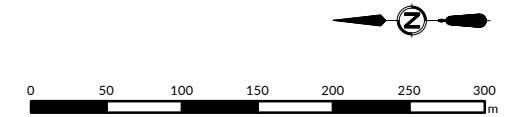

Imagery: Esri, DigitalGlobe, GeoEye, i-cubed, USDA FSA, USGS, AEX, Getmapping, Road: Statistics Canada, 2019; Hydrography: Altalis Ltd., 1996; ATS Grid: Altalis Ltd., 2005; Historic Resource: Government of Alberta, 2021.

AE PROJECT No.	2021-3981
DATE	2021 NOVEMBER
SCALE	1:5,000
COORD. SYSTEM	NAD 1983 3TM 114
REV	1
DESCRIPTION	ISSUED FOR REPORT
DRAWN BY	WL
CHECKED BY	KP

FIGURE 3-8
Historical Resources

TWD Stage 2 Upgrades and
 RVB Renewal and Widening
 Fox Drive Interchange

Environmental Impact Assessment

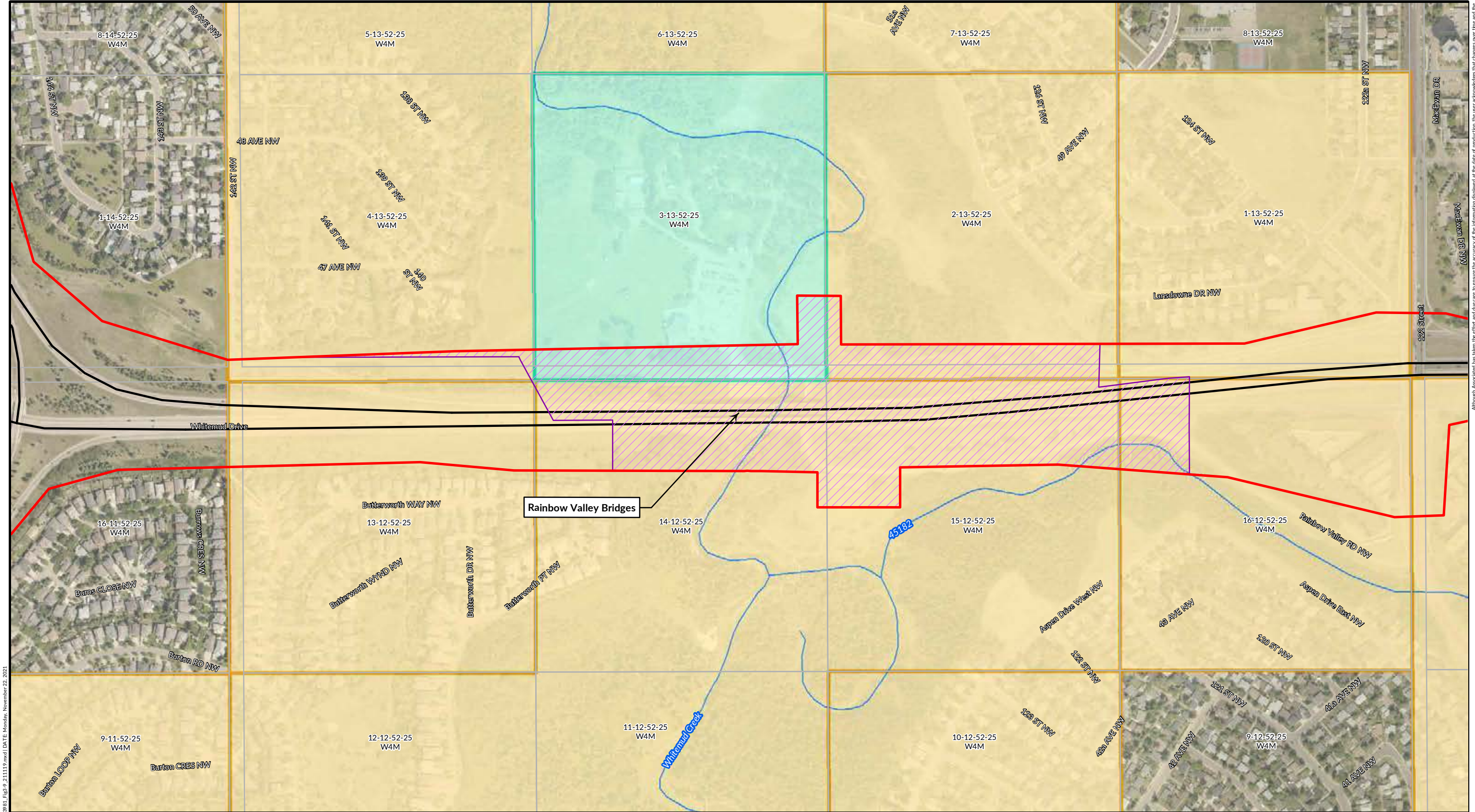

FILE: C:\Users\law\Desktop\Proj\ArchMap\Rev\VAE2021\981L_Figs\Fig_3-9_211119.mxd | DATE: Monday, November 22, 2021

Although Associated has taken the effect and date to prepare this report, the user acknowledges that changes over time and the currency of the datasets may impact the accuracy of the information without notice. Associated shall not be held liable towards the results obtained from the use of this information.



- Legend**
- Project Area
 - HRV 4
 - Study Area
 - HRV 5
 - Base Data**
 - Highway
 - Watercourse

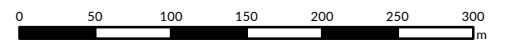

AE PROJECT No.	2021-3981
DATE	2021 NOVEMBER
SCALE	1:5,000
COORD. SYSTEM	NAD 1983 3TM 114
REV	1
DESCRIPTION	ISSUED FOR REPORT
DRAWN BY	WL
CHECKED BY	KP

FIGURE 3-9
Historical Resources

TWD Stage 2 Upgrades and
 RVB Renewal and Widening
 Rainbow Valley Bridges

Environmental Impact Assessment

3.7 Contaminated Sites

A limited Phase I Environmental Site Assessment (ESA) ([Appendix D](#)) was completed by Associated in August 2020 and a Phase II ESA ([Appendix E](#)) was completed by Associated in July 2021 for the project.

The limited Phase I ESA encompassed a 4.9 km segment of Whitemud Drive. Based on the results of this ESA, there is high potential that current or past land use activities at Whitemud Drive have resulted in contamination of soil, vapour, and/or groundwater. Two areas of potential environmental concern (APECs) were identified:

- APEC 1: A diesel spill area near Rainbow Valley Bridges where sampling for Per- and polyfluoroalkyl substances related to firefighting foam was not completed.
- APEC 2: Salt staining present along Whitemud Drive.

The Phase II ESA was completed in the project area to assess shallow soil quality along Whitemud Drive and identify contaminants of concern that may be encountered during project earthworks and construction. The Phase II ESA concluded that there are salt impacts in soil from ground surface to the maximum depth of investigation where salinity was tested (1.0 mbgs). Contaminants of concern include chloride and sodium. Soils within the entire project area are considered to be impacted by historical road salt applications and soils from all depths should be considered as salt-impacted.

A Contaminated Soils Management Strategy (CSMS) was developed to outline measures to for the management of both clean and contaminated soil generated through the excavation works associated with the project ([Appendix F](#)). Procedures pertaining to excavation, stockpiling, soil re-use or disposal, import fill/soils, surface and groundwater, and contamination discovery are described in detail in the CSMS and referenced under the mitigation measures section of this report.

A discussion with Alberta Environment and Parks is planned to confirm whether the CSMS approach is acceptable to manage salt contamination within roadways. The CSMS may be revised following discussions with Alberta Environment and Parks.

4 THE PROJECT

The Terwillegar Drive Stage 2 project is a part of the City's plan to support the projected growth of travel demand in southwest Edmonton.

The Stage 2 concept planning study was initiated by the City in 2019 and completed in 2020. The study included a condition assessment of the Rainbow Valley Bridges, a transit planning study between the Whitemud Drive / Terwillegar Drive interchange and South Campus LRT Station, conceptual roadway planning, and conceptual rehabilitation and widening strategy for the Rainbow Valley Bridges. The project is currently in preliminary design with several main components including:

- Rainbow Valley Bridges Rehabilitation and Widening;
- New Pedestrian / Cyclist Bridge over Whitemud Creek;
- Terwillegar Drive / Whitemud Drive Interchange;
- 53 Avenue /Terwillegar Drive Bus Only Ramp Retaining Wall;
- 53 Avenue over Whitemud Drive Bridge; and
- Whitemud Drive over Fox Drive Bridge.

Draft preliminary design drawings are located in [Appendix G](#). Detailed information on the components and activities occurring inside the Bylaw 7188 area is provided in the subsections below. The construction of noise walls was considered as a part of this project and a draft noise impact assessment ([Appendix H](#)) was completed; however, at this time, no noise walls have been included in the design.

Laydown / staging areas for widening of the Rainbow Valley Bridges and construction of the new pedestrian bridge will be located in the snow valley overflow parking lot, an open grassy area to the north of Rainbow Valley Road just east of the Rainbow Valley Access Bridge, and / or at the Whitemud Park parking and immediately surrounding open landscaped area. The Whitemud Park laydown area has the potential to become a permanent expansion of the existing parking lot following project completion; however, a decision on the permanence of the parking lot expansion has not yet been made. A figure outlining the location of the proposed laydowns and other disturbance areas can be found in [Figure 4-1](#) and [4-2](#). The planned grading limits for the construction phase of the project are also shown on [Figure 4-1](#) and [4-2](#).

4.1 Rainbow Valley Bridges Rehabilitation and Widening

The westbound bridge (B162) was constructed in 1979 and the eastbound bridge (B180) was constructed in 1982. Both bridges span over Whitemud Creek and Rainbow Valley Road with overall lengths of approximately 189 m. The westbound bridge is 15 m wide and the eastbound bridge is 16 m wide. Both bridges carry three lanes of traffic with approximately 55,000 vehicles per day on Whitemud Drive. Both bridge superstructures consist of four spans (42.7 m – 51.8 m – 51.8 m – 42.7 m).

Rehabilitation of the Rainbow Valley Bridges includes:

- Girder repairs and new girder installation for widening;
- Deck replacement;
- Barrier replacement;
- Roof slab replacement;
- Approach slab replacement;
- Wing wall removal;
- Partial depth repairs of abutments;

- Pedestal repairs;
- New drainage installation;
- Sealing of exterior/interior surface;
- Slope protection replacement;
- Bearing replacement;
- Deck joint replacement;
- Abutment widening; and
- New pier installation for road widening.

Preliminary design included two types of deck rehabilitations and five types of wearing surface systems. The substructure and girders were the same for all options. It was determined that a partial depth deck and reinforcing replacement would be completed with HPC steel fibre overlay.

The eastbound and westbound bridge decks will be widened by approximately 5.5 and 6.6 m, respectively. To support this widening, six new single column concrete piers will be placed immediately adjacent to the existing piers. Each of the piers will be supported by newly placed concrete bell piles. The middle pier of the eastbound bridge is directly adjacent to Whitemud Creek. The piles extend beneath Whitemud Creek and the bottom portion of the aboveground pier occurs within the 1:100 year flood elevation of the creek. The bottom portion of the eastern most pier of the westbound bridge occurs within the 1:100 year flood elevation of Whitemud Creek. Instream work is required for construction of the new piers. Mitigations related to instream work can be found in [Section 6.3](#).

Lighting on the bridges will be replaced during widening. Lighting will be switched to LED to reduce spillage; however, additional lighting will be required to illuminate the widened area of the bridge.

4.2 New Pedestrian / Cyclist Bridge over Whitemud Creek

The new pedestrian / cyclist bridge will be a three span (58.0 m – 70.0 m – 58.0 m) single steel trapezoidal box girder bridge that will match the vertical profile of the existing Rainbow Valley Bridges. This new bridge will be approximately 5 m north of the widened westbound bridge. A new concrete deck will be installed over the steel trapezoidal box girders. The new piers will be a reinforced concrete shaft supported on 1.0 m diameter concrete piles with a pile cap. The piers will be in a different arrangement as the Rainbow Valley Bridges because there are only three spans. Conventional style abutments, made of cast-in-place reinforced concrete, will be installed and supported by steel HP piles.

Lighting on the new bridge is still in design; however, LED lights will be used to reduce spillage and less lighting will be used compared to the Rainbow Valley Bridges to reduce wildlife disturbance during operation.

4.3 Retaining Walls

Three retaining walls are planned as part of the project. These retaining walls will reduce the requirements for extensive grading and vegetation clearing, such that areas to the outside of the retaining walls will be undisturbed. One of the retaining walls is located within the study area and the other two are outside of it and in the overall project area. The planned locations of the retaining walls are shown on [Figure 4-1](#) and [4-2](#).

4.4 Landscape Restoration and Enhancement

A landscape / restoration plan is being developed as part of detailed designs to address the restoration of temporarily disturbed areas and the enhancement of the surrounding landscape. The landscape / restoration plan will be included as part of the 60% detailed design submission for the project and will be circulated to appropriate City reviewers.

The amount of vegetation to be removed during construction is currently being confirmed and will be communicated with the City's Urban Forestry and Natural Area Operations groups. Once these groups provide the asset value of vegetation in the vegetation removal areas, a multiplier will be determined and applied to calculate the asset value of vegetation within a 2 m root perimeter around each area. The project will replace total asset value provided by the City plus the asset value of vegetation in the 2 m root perimeter areas.

The landscape / restoration plan will account for the ecological information identified in this EIA report. Tree compensation is planned and will be prioritized in areas where it will supplement existing tree planting adjacent to residential developments, provide noise and visual buffering, add to existing corridor access, and enhance the landscape around new infrastructure. In addition to the tree compensation, native tree and shrub reclamation may be used at the eastbound and westbound bridges, the new pedestrian / cyclist bridge, and retaining wall locations. Topsoil replacement and the use of native seed mixtures will be used to restore areas where woody vegetation is not planned. It is anticipated that imported topsoil will be needed to supplement use of native topsoil and achieve the City's standards for topsoil depth (300 mm).

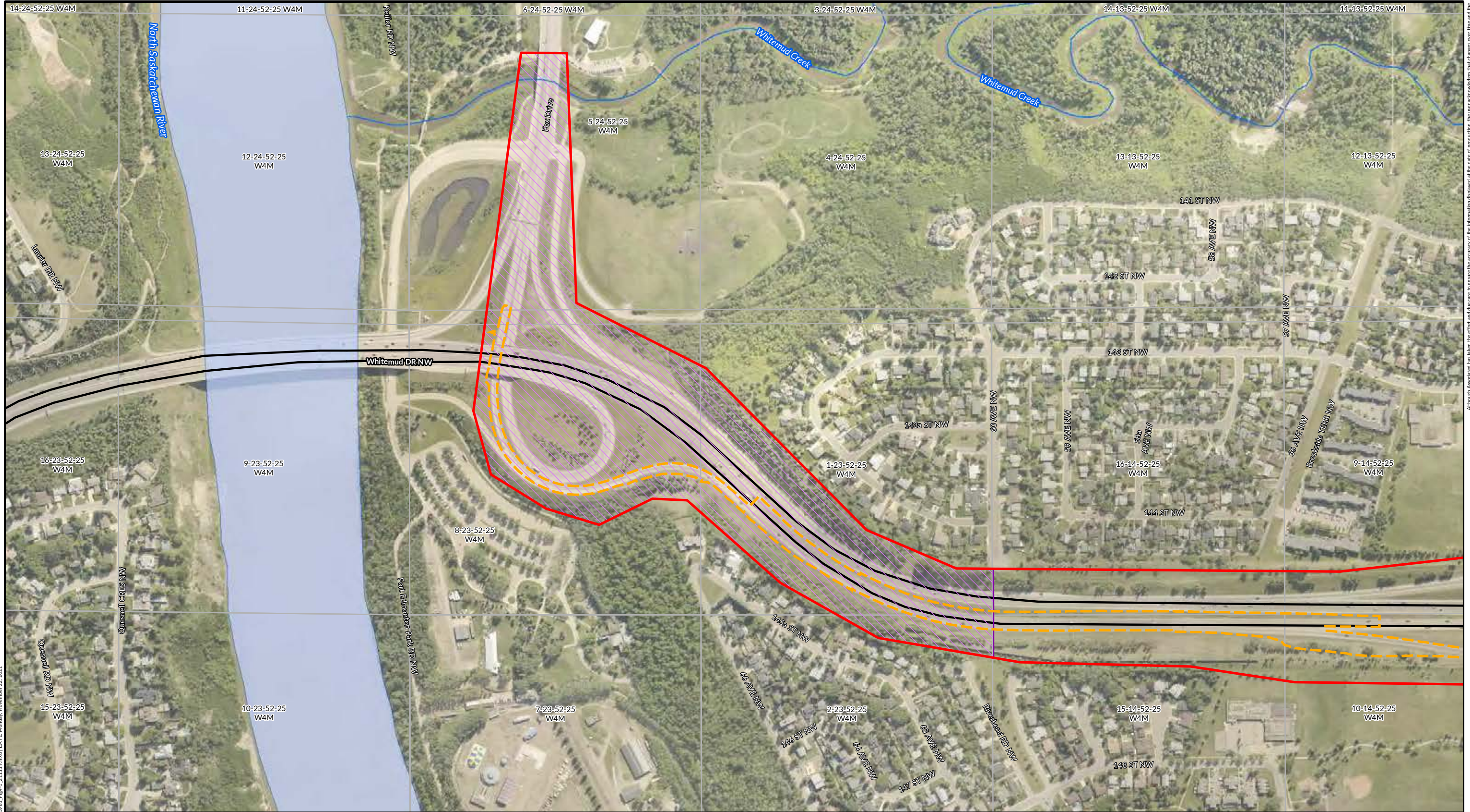

FILE: C:\Users\law\Desktop\Proj\ArchMap\Rev1\AE\2021\9981_Fig-1_211119.mxd | DATE: Monday, November 22, 2021

Although Associated has taken the effort and expense to prepare this accuracy of the information displayed in this plan. We are not responsible for the accuracy of the information. Associated shall not be held liable towards the results obtained from the use of this information.



Legend

- Grading Limit
- Project Area
- Study Area
- Highway
- Watercourse
- Water Body

Base Data

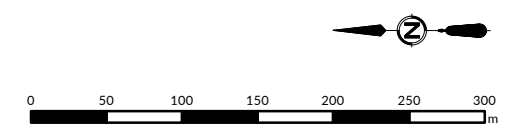

Imagery: Esri, DigitalGlobe, GeoEye, i-cubed, USDA FSA, USGS, AEX, Getmapping, Road: Statistics Canada, 2019; Hydrography: Altalis Ltd., 1996; A1S Grid: Altalis Ltd., 2005; Bylaw 7188 Area: Associated Engineering 2020; Bylaw Zones: City of Edmonton 2020.

AE PROJECT No.	2021-3981
DATE	2021 NOVEMBER
SCALE	1:5,000
COORD. SYSTEM	NAD 1983 3TM 114
REV	1
DESCRIPTION	ISSUED FOR REPORT
DRAWN BY	WL
CHECKED BY	EC

FIGURE 4-1
Project Components
 TWD Stage 2 Upgrades and
 RVB Renewal and Widening
 Fox Drive Interchange
 Environmental Impact Assessment

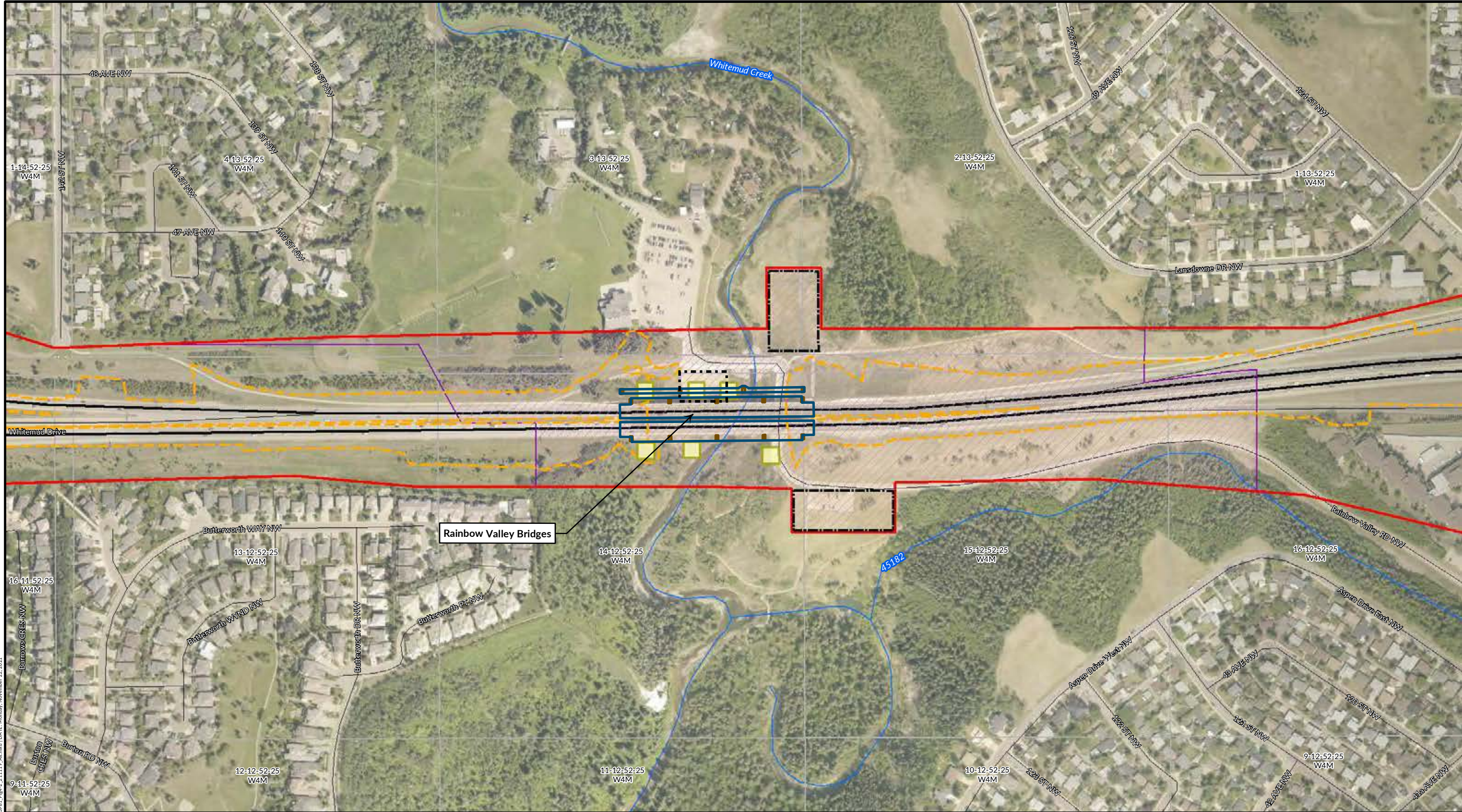

FILE: C:\Users\law\Desktop\Proj\ArchMap\Rev\VAE\2021\9818_L_Fig_2_211119_Air.mxd | DATE: Monday, November 22, 2021

Although Associated has taken the effort and expense to prepare the accuracy of the information displayed on this site, it understands that no warranty, representation, or acknowledgment that changes over time and the accuracy of the data(s) may impact the accuracy of the information without notice. Associated shall not be held liable towards the results obtained from the use of this information.



- Legend**
- Bridge
 - Crane Pad
 - Grading Limit
 - Potential Laydown And Parking
 - Pier
 - Project Area
 - Study Area
- Base Data**
- Highway
 - Watercourse

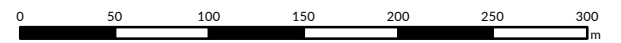

AE PROJECT No.	2021-3981
DATE	2021 NOVEMBER
SCALE	1:4,000
COORD. SYSTEM	NAD 1983 3TM 114
REV	1
DESCRIPTION	ISSUED FOR REPORT
DRAWN BY	WL
CHECKED BY	EC

FIGURE 4-2
Project Components

TWD Stage 2 Upgrades and
 RVB Renewal and Widening
 Rainbow Valley Bridges

Environmental Impact Assessment

Imagery: Esri, DigitalGlobe, GeoEye, i-cubed, USDA FSA, USGS, AEX, Getmapping, Road: Statistics Canada, 2019; Hydrography: Altalis Ltd., 1996; A1S Grid: Altalis Ltd., 2005; Bylaw 7188 Area: Associated Engineering 2020; Bylaw Zones: City of Edmonton 2020.

5 REGULATORY FRAMEWORK

A summary of the permitting requirements for the project is provided in **Table 5-1**. This information is based on a review of environmental sensitivities and the current understanding of the project area based on the preliminary design information. These regulatory requirements should be revisited throughout project planning and detailed design as they are subject to change.

Regulatory permits requirements are to be considered in the development of the detailed design report for the project. All permits must be in place prior to the start of construction activities. An Approvals Package will be issued following receipt of all project permits, to be included in the project tender package and kept on site during construction.

An overview of environmental legislation with recommendations and general practices to promote project compliance is available in **Table 5-2**. Recommendations for project compliance are relevant to the construction phase of the project and are important for the contractor to be aware of and incorporate into their project-specific Environmental Construction Operations (ECO) Plan.

**Table 5-1
Anticipated Environmental Permitting Required for the Project**

Legislation / Permit Type	Trigger	Notes on Requirements	Estimated Agency Review Timeline	Date Submitted	Approval Date	Expiry Date
Federal						
<i>Fisheries Act / Request for Review</i>	Instream construction activities below the high-water mark of Whitemud Creek or with the potential to cause serious harm to fish and/or fish habitat (i.e., permanent loss of fish habitat).	<p>A Request for Review will be submitted to Fisheries and Oceans Canada to determine if Authorization is required.</p> <p>Given the current extent of disturbance, Authorization is not anticipated.</p>	6-8 weeks	In-progress	TBD	N/A
<i>Canadian Navigable Waters Act / Approval</i>	A new pedestrian bridge and bridge widening over Whitemud Creek including the bridge substructure (i.e., separate works from surface bridge deck repairs such as scaffolding) fall under the <i>Major Works Order</i> . Whitemud Creek is not a scheduled water body under this Act; however, it is considered navigable.	<p>Approval is required for activity on navigable waters. The submission requires design information for works within the navigation envelope.</p> <p>Project to be posted on a public registry for 30 days.</p>	6-8 months	In-progress	TBD	N/A
Provincial						
<i>Environmental Protection and Enhancement Act / Notification</i>	Extensions or replacements of existing stormwater or wastewater collection systems require Notification under the <i>Wastewater and Storm Drainage Regulation</i> (Alberta Regulation 119/1993) of this Act.	Stamped and signed design drawings are required for submission of notifications.	N/A	TBD	TBD	N/A

Legislation / Permit Type	Trigger	Notes on Requirements	Estimated Agency Review Timeline	Date Submitted	Approval Date	Expiry Date
<i>Historical Resources Act / Approval</i> File No. 4715-21-0020-001	New construction/ground disturbance within designated Historical Resource Value (HRV) lands.	<p>A Historical Resources Approval (Number: 4715-21-0020-001) for the project was obtained on April 22, 2021 and a <u>Historical Resources Impact Assessment</u> was subsequently completed.</p> <p>Submit an amendment application if the project footprint changes.</p>	2-4 months	<p>Approval: March 10, 2021</p> <p>HRIA: June 24, 2021</p>	<p>April 22, 2021.</p> <p>HRIA: September 22, 2021</p>	N/A
<i>Public Lands Act / Temporary Field Authorization (TFA)</i>	Temporary works/activities occurring on Crown administered lands. The bed and shore of Whitemud Creek are Crown land.	Obtain a TFA if temporary workspace extends outside of the ROW, below the high-water mark of Whitemud Creek.	2 months	As the TFA is required to support construction, the contractor shall be responsible for obtaining this permit.	TBD	TBD
<i>Water Act Code of Practice for Watercourse Crossings / Notification</i>	Instream construction activities.	<p>Whitemud Creek is a Class B water body with a RAP of April 16 to June 30.</p> <p>Notification requires written specifications and recommendations prepared by a Qualified Aquatic Environment Specialist (QAES).</p>	2 weeks (Notification period prior to the start of construction)	TBD	TBD	TBD
Municipal						

Legislation / Permit Type	Trigger	Notes on Requirements	Estimated Agency Review Timeline	Date Submitted	Approval Date	Expiry Date
Bylaw 7188 / Initial Project Review Form File No. 403036550-001, 389117472-001, 394474708-001, 389117472-001	Vegetation clearing, use of pathways, and trail closure notifications required for the geotechnical investigation and utility hydrovac.	A new project review form was required for additional boreholes during the geotechnical investigation. Approval was obtained prior to all works.	1 month	June 28, 2021 May 19, 2021 April 29, 2021 March 11, 2021	August 11, 2021 June 1, 2021 May 28, 2021 March 30, 2021	N/A
Bylaw 7188 / Environmental Impact Assessment Approval	All development in the North Saskatchewan River Valley and Ravine System requires an Environmental Impact Assessment (EIA). A Site Location Study (SLS) is also required.	Approval of the EIA and SLS (Appendix I) is required under the Bylaw. This includes approval by River Valley Bylaw and Edmonton City Council.	6 months	September 17, 2021	TBD	N/A
Bylaw 2202 / Parkland Access Permit File No. 391053806-001 341221211-001	Access to lands zoned as parkland.	The City's Project Manager will coordinate with Parkland Management personnel to arrange for appropriate permits to support activities in parkland areas.	1 month	TBD	TBD	TBD

**Table 5-2
Environmental Legislation and Recommendations for General Compliance**

Legislation	Recommendations and General Practices for Compliance
Federal	
<p><i>Migratory Birds Convention Act</i> S.C. 1994, c. 22 This Act protects migratory birds, their eggs, and their active nests.</p>	<ul style="list-style-type: none"> • Conduct vegetation clearing activities outside of the general bird nesting period for the region (mid April to late August). • Consult with a qualified professional if vegetation clearing activities must be completed within this period. • Conduct a pre-construction bird nest sweep by a qualified professional with a valid permit prior to any vegetation clearing activities within the general bird nesting period.
<p><i>Species at Risk Act</i> S.C. 2002, c. 29 This Act regulates activities with potential to impact species at risk/of concern and/or their habitat.</p>	<ul style="list-style-type: none"> • Engage a qualified professional and/or federal representative from the Canadian Wildlife Service if a species at risk is encountered during project construction. • Stop work and implement additional mitigation measures if required.
Provincial	
<p><i>Environmental Protection and Enhancement Act</i> R.S.A. 2000, c. E-12 This Act regulates activities with potential for environmental contamination.</p>	<ul style="list-style-type: none"> • Develop an Environmental Construction Operations (ECO) Plan that addresses erosion and sediment controls and spill prevention and response. • Perform weekly environmental monitoring to ensure that project activities are not resulting in sedimentation or contamination.
<p><i>Soil Conservation Act</i> R.S.A. 2000, c. S-15 This Act imposes a duty upon every landholder to take appropriate measures to prevent soil loss or deterioration, or to mitigate the same where it has occurred.</p>	<ul style="list-style-type: none"> • Incorporate permanent erosion control measures as part of designs such as bioengineering or retaining walls. • Develop an Erosion and Sediment Control Plan as part of the project specific ECO Plan.
<p><i>Weed Control Act</i> S.A. 2008, c. W-5.1 This Act regulates the specific weed species that are listed in Schedule 1 (prohibited noxious weeds) and Schedule 2 (noxious weeds) of the Act.</p>	<ul style="list-style-type: none"> • Incorporate measures to prevent the introduction and spread of weed species in the ECO Plan. • Ensure equipment arrives on site in clean condition. • Use seed mixes that have been certified free of noxious and prohibited noxious weeds for any revegetation activities. • Destroy any prohibited noxious weeds and control noxious weeds in project area.

Legislation	Recommendations and General Practices for Compliance
<p>Wildlife Act R.S.A. 2000, c. W-10 This Act prohibits wilful molestation, disruption, or destruction of wildlife, or a house, nest, or den of wildlife.</p>	<ul style="list-style-type: none"> • Conduct vegetation clearing activities outside of migratory and non-migratory bird nesting periods (mid February to late August). • Consult with a qualified professional if vegetation clearing activities must be completed within this nesting period. • Follow appropriate mitigation strategies to prevent/minimize potential human-wildlife interactions during construction activities, such as removing wastes from site. • If an active nest, den or animal residence is discovered within the project area, stop work and consult a qualified professional.
Municipal	
<p>Community Standards Bylaw 14600 (City of Edmonton 2020b) This Bylaw regulates noise within the city. Under this Bylaw, construction activity is restricted to a timeframe between 7 a.m. and 9 p.m. on most days other than Sundays and holidays when construction is restricted to a timeframe between 9 a.m. and 7 p.m.</p>	<ul style="list-style-type: none"> • Adhere to time restrictions for construction activities. • Contact City representative if construction is required outside of these time periods as a permit may be required.
<p>Corporate Tree Management Policy C456A (City of Edmonton 2020a) This policy protects the tree canopy on City lands from destruction, loss, or damage. The Urban Forestry unit determines the financial value of ornamental trees based on their size, species, and condition, and the Natural Area Operations unit determines the valuation of areas of natural vegetation to be removed. These units coordinate vegetation removal activities.</p>	<ul style="list-style-type: none"> • Maintain engagement with Natural Areas Operations regarding vegetation removal requirements in the natural areas. • Engage Urban Forestry for project conflicts with natural tree stands or landscape trees on City lands. • Submit a Tree Preservation/Protection Plan for approval through Natural Areas Operations prior to the start of construction. The tree preservation/protection plan must separate inventoried and non inventoried trees within the City.
<p>Public Tree Bylaw 18825 (City of Edmonton 2021c) This bylaw preserves and protects trees in public spaces owned by the City of Edmonton.</p>	<ul style="list-style-type: none"> • Coming into force May 2022. • Obtain a permit to work within 5m of the trunk of any boulevard and open space tree or within 10m of any boundary of a natural stand. • Obtain an approval for a tree preservation plan and/or tree protection plan for all work within 5m of the trunk of any boulevard and open space tree or within 10m of any boundary of a natural stand. The tree preservation/protection plan must separate inventoried and non inventoried trees within the City.

Legislation	Recommendations and General Practices for Compliance
<p>Drainage Bylaw 18093 (City of Edmonton 2019) This Bylaw regulates surface drainage on public and private land and fosters the well-being of the environment by prohibiting the release of dangerous or hazardous materials into the sewerage system.</p>	<ul style="list-style-type: none"> • Incorporate mitigation measures to prevent releases of prohibited wastes and control releases of restricted wastes into the sewerage system.
<p>EPCOR Drainage Bylaw 18100 (City of Edmonton 2020c) The purpose of this Bylaw is to approve the terms and conditions for drainage services and a mechanism whereby Drainage Services Guidelines may be implemented by EPCOR Water Services Inc.</p>	<ul style="list-style-type: none"> • Obtain permission from EPCOR to use their infrastructure and ensure water quality meets the standards outlined in this Bylaw.

6 PROJECT IMPACTS AND MITIGATION MEASURES

6.1 Environmental Impacts

6.1.1 Groundwater, Surface Water, and Fish

The potential project impacts on groundwater, surface water, and fish habitat are presented in [Table 6-1](#).

Table 6-1
Project Impacts on Groundwater, Surface Water, and Fish

Ecosystem Component	Direction and Description of Impact	Characteristics of Impact Before Mitigation Measures
Groundwater – Exposed groundwater from construction excavations on land	Negative – Excess withdrawal of groundwater from construction dewatering activities.	Nature: Direct Magnitude: Low Spatial Extent: Local Duration: Long-term Likelihood: Low
Groundwater – Exposed groundwater from construction excavations on land	Negative – Contamination of groundwater within excavations from construction materials.	Nature: Direct Magnitude: Low Spatial Extent: Local Duration: Long-term Likelihood: Low
Groundwater – Exposed groundwater from construction excavations on land	Negative – Contamination of groundwater within excavations from previously contaminated soils.	Nature: Direct Magnitude: Low Spatial Extent: Local Duration: Long-term Likelihood: Low
Surface Water – Bed and banks of Whitemud Creek	Negative – Erosion of downstream bed and banks due to changes in flow/velocity as a result of instream isolation.	Nature: Indirect Magnitude: Moderate Spatial Extent: Local Duration: Long-term Likelihood: Moderate
Surface Water – Water quality in Whitemud Creek	Negative – Sedimentation of Whitemud Creek from instream works to install bridge piers and/or erosion of bare soil during construction.	Nature: Direct Magnitude: Moderate Spatial Extent: Local Duration: Short-term Likelihood: High
Surface Water and Fish Habitat – Whitemud Creek	Negative – Contamination of Whitemud Creek from materials used during the construction.	Nature: Indirect Magnitude: Moderate Spatial Extent: Local Duration: Long-term Likelihood: Moderate
Surface Water and Soils – Stormwater runoff	Negative – Changes to local hydrology patterns and increased impervious surface causing increased amount of stormwater drainage and erosion.	Nature: Indirect Magnitude: Moderate Spatial Extent: Local Duration: Long-term Likelihood: High

Ecosystem Component	Direction and Description of Impact	Characteristics of Impact Before Mitigation Measures
Fish Habitat – Aquatic habitat in Whitemud Creek	Negative – Temporary isolation installed in water resulting in the temporary loss and alteration of fish habitat.	Nature: Direct Magnitude: High Spatial Extent: Local Duration: Short-term Likelihood: Certain
Fish – Fish inhabiting Whitemud Creek	Negative – Increased sedimentation of fish habitat from instream construction, and sediment-laden runoff.	Nature: Indirect Magnitude: Moderate Spatial Extent: Local Duration: Short-term Likelihood: Moderate
Fish – Fish inhabiting Whitemud Creek	Negative – Death or injury to fish during the fish rescue for instream work.	Nature: Direct Magnitude: Low Spatial Extent: Local Duration: Long-term Likelihood: Low
Fish – Fish inhabiting Whitemud Creek	Negative – Sensory disturbance to fish from construction lighting and noise.	Nature: Direct Magnitude: Low Spatial Extent: Local Duration: Short-term Likelihood: Moderate
Fish – Fish inhabiting Whitemud Creek	Negative – Spread of whirling disease and/or invasive species.	Nature: Indirect Magnitude: Moderate Spatial Extent: Regional Duration: Long-term Likelihood: Moderate

6.1.2 Geomorphology, Geology, and Soils

The potential project impacts on geology, geomorphology, and soils are presented in [Table 6-2](#).

Table 6-2
Project Impacts on Geomorphology, Geology, and Soils

Ecosystem Component	Direction and Description of Impact	Characteristics of Impact Before Mitigation Measures
Soils – Areas of native soil	Negative – Removal and replacement of native topsoil with non-native fill or use of imported topsoil for restoration.	Nature: Direct Magnitude: Moderate Spatial Extent: Local Duration: Long-term Likelihood: Moderate
Soils – Areas of native soil or fill	Negative – Contamination of soils from spills of construction materials or equipment leaks.	Nature: Direct Magnitude: Moderate Spatial Extent: Local Duration: Long-term

Ecosystem Component	Direction and Description of Impact	Characteristics of Impact Before Mitigation Measures
		Likelihood: Moderate
Soils – Exposed soils during construction phase, specially during unfrozen conditions	Negative – Erosion of exposed soil resulting in loss of material.	Nature: Direct Magnitude: Low Spatial Extent: Local Duration: Long-term Likelihood: High
Soils – Areas of contaminated soils exposed during construction	Negative – Exposure of contaminated soils to precipitation can cause the contamination of surface water.	Nature: Direct Magnitude: Low Spatial Extent: Local Duration: Long-term Likelihood: High
Surface Water and Soils – Stormwater runoff	Negative – Changes to local hydrology patterns and increased impervious surface causing increased amount of stormwater drainage and erosion.	Nature: Indirect Magnitude: Moderate Spatial Extent: Local Duration: Long-term Likelihood: High

6.1.3 Vegetation

The potential project impacts on vegetation are presented in [Table 6-3](#).

Table 6-3
Project Impacts on Vegetation

Ecosystem Component	Direction and Description of Impact	Characteristics of Impact Before Mitigation Measures
Vegetation – Native plants in North Saskatchewan River valley	Negative – Temporary and permanent loss of native plants and vegetation structure in the study area from removal of vegetation.	Nature: Direct Magnitude: Moderate Spatial Extent: Local Duration: Long-term Likelihood: Certain
Vegetation – Landscaped vegetation in the study area	Negative – Removal and damage of landscaped vegetation, including trees, shrubs, and maintained grass from construction activities.	Nature: Direct Magnitude: Low Spatial Extent: Local Duration: Long-term Likelihood: High
Vegetation – Existing populations of weeds and non-native plants	Negative – Introduction and/or spread of weed populations and non-native plants.	Nature: Indirect Magnitude: Low Spatial Extent: Local Duration: Long-term Likelihood: Moderate
Vegetation – Existing populations of rare plants	Negative – Accidental destruction of rare plants.	Nature: Direct Magnitude: Low Spatial Extent: Local

Ecosystem Component	Direction and Description of Impact	Characteristics of Impact Before Mitigation Measures
		Duration: Long-term Likelihood: Low

6.1.4 Wildlife

The potential project impacts on wildlife are presented in [Table 6-4](#).

Table 6-4
Project Impacts on Wildlife

Ecosystem Component	Direction and Description of Impact	Characteristics of Impact Before Mitigation Measures
Wildlife – Wildlife passage and habitat connectivity	Negative – Restriction of wildlife movement between habitats in the Whitemud Ravine at operational stage of rehabilitated bridges and new pedestrian / cyclist bridge.	Nature: Direct Magnitude: High Spatial Extent: Regional Duration: Long-term Likelihood: Moderate
Wildlife – Wildlife passage and habitat connectivity	Negative – Restriction of wildlife movement between habitats in the Whitemud Ravine and the North Saskatchewan River valley during construction.	Nature: Direct Magnitude: High Spatial Extent: Regional Duration: Short-term Likelihood: Moderate
Wildlife – Bird nesting habitat within the native or landscaped vegetation	Negative - Temporary or permanent loss of bird nesting habitat from vegetation removal to support construction and operation.	Nature: Direct Magnitude: Moderate Spatial Extent: Local Duration: Long-term Likelihood: High
Wildlife – Actively nesting birds within or adjacent to construction limits	Negative - Incidental take of active bird nests from construction activities.	Nature: Direct Magnitude: High Spatial Extent: Local Duration: Short-term Likelihood: Moderate
Wildlife – Sensory perceptions of individuals using habitats near construction	Negative – Interference of hearing or sight from construction noise or use of artificial lighting during construction and operation.	Nature: Direct Magnitude: Low Spatial Extent: Local Duration: Long-term Likelihood: Moderate

6.1.5 Historical Resources

The potential project impacts on historical resources are presented in [Table 6-5](#).

**Table 6-5
Project Impacts on Historical Resources**

Ecosystem Component	Direction and Description of Impact	Characteristics of Impact Before Mitigation Measures
Historical Resources – Potentially undiscovered archaeological, palaeontological, and/or provincially designated historic resources and/or Indigenous traditional use sites within study areas.	Negative – Disturbance of unanticipated historic resources through ground disturbance activities during construction.	Nature: Direct Magnitude: Moderate Spatial Extent: Local Duration: Short-term Likelihood: Low

6.1.6 Contaminated Sites

The potential project impacts on contaminated sites are presented in [Table 6-6](#).

**Table 6-6
Project Impacts on Contaminated Sites**

Ecosystem Component	Direction and Description of Impact	Characteristics of Impact Before Mitigation Measures
Contamination – Existing wastes or debris in construction area	Negative – Deposition of wastes into excavations or Whitemud Creek during construction activities.	Nature: Direct Magnitude: Low Spatial Extent: Local Duration: Long-term Likelihood: Moderate
Contamination – Salinity impacted soils	Negative – Transfer of soils with high salinity to locations outside of the project area resulting in salinity impacts on soil and water elsewhere.	Nature: Indirect Magnitude: Low Spatial Extent: Regional Duration: Long-term Likelihood: High
Contamination – Soils potentially containing chemicals commonly found within firefighting foams at site of former diesel spill	Negative – Transfer of chemicals to locations outside of the project area resulting in impacts on soil and water elsewhere.	Nature: Indirect Magnitude: Low Spatial Extent: Regional Duration: Long-term Likelihood: Low

6.2 Identifying Cumulative Impacts

Minimal cumulative impacts are anticipated, including a small increase in surface water discharge from the road/bridge widening. This is considered inconsequential to the overall drainage throughout the area. The project will have some localized impacts surrounding Whitemud Creek with the addition of new piers for the Rainbow Valley Bridges and a new pedestrian bridge; however, there is previous development in the area and direct construction within the water body is not anticipated.

There is extensive vegetation removal required in the project area and outside of the study area. Most of the vegetation removal outside of the study area occurs in areas of maintained turf and non-maintained grass. Scattered trees occur throughout most of the areas where vegetation removal is required. Vegetation removal is required within the grading limits of the project; however, vegetation to the outside of the planned retaining walls will be maintained (Figure 6-1 and 6-2). All vegetation removals that are part of the project require coordination with the City of Edmonton Natural Areas Operations, Parks and Landscape Inventory, and Urban Forestry units. Restoration of the entire project area, including the replacement of trees, will be outlined in a project specific landscape / restoration plan that is being developed as part of detailed design. The landscape / restoration plan will include tree compensation that will be prioritized in areas that are near to residential neighbourhoods and adjacent to new infrastructure, such as shared use paths. A combination of native and imported topsoil will be used to establish a topsoil depth of 300 mm where native seed mixes will be applied to vegetated areas temporarily disturbed through construction. Native tree / shrub reclamation will be prioritized in areas around the widened eastbound and westbound bridges, the new pedestrian / cyclist bridge over Whitemud Creek, and areas where retaining walls are implemented. There will be a temporal delay in the regrowth of restored vegetation. Additionally, there will be a lesser volume of vegetated areas due to the widening of the existing roadway. Cumulative impacts as a result of vegetation removal are expected to be minimal following restoration and temporal delays associated with regrowth.

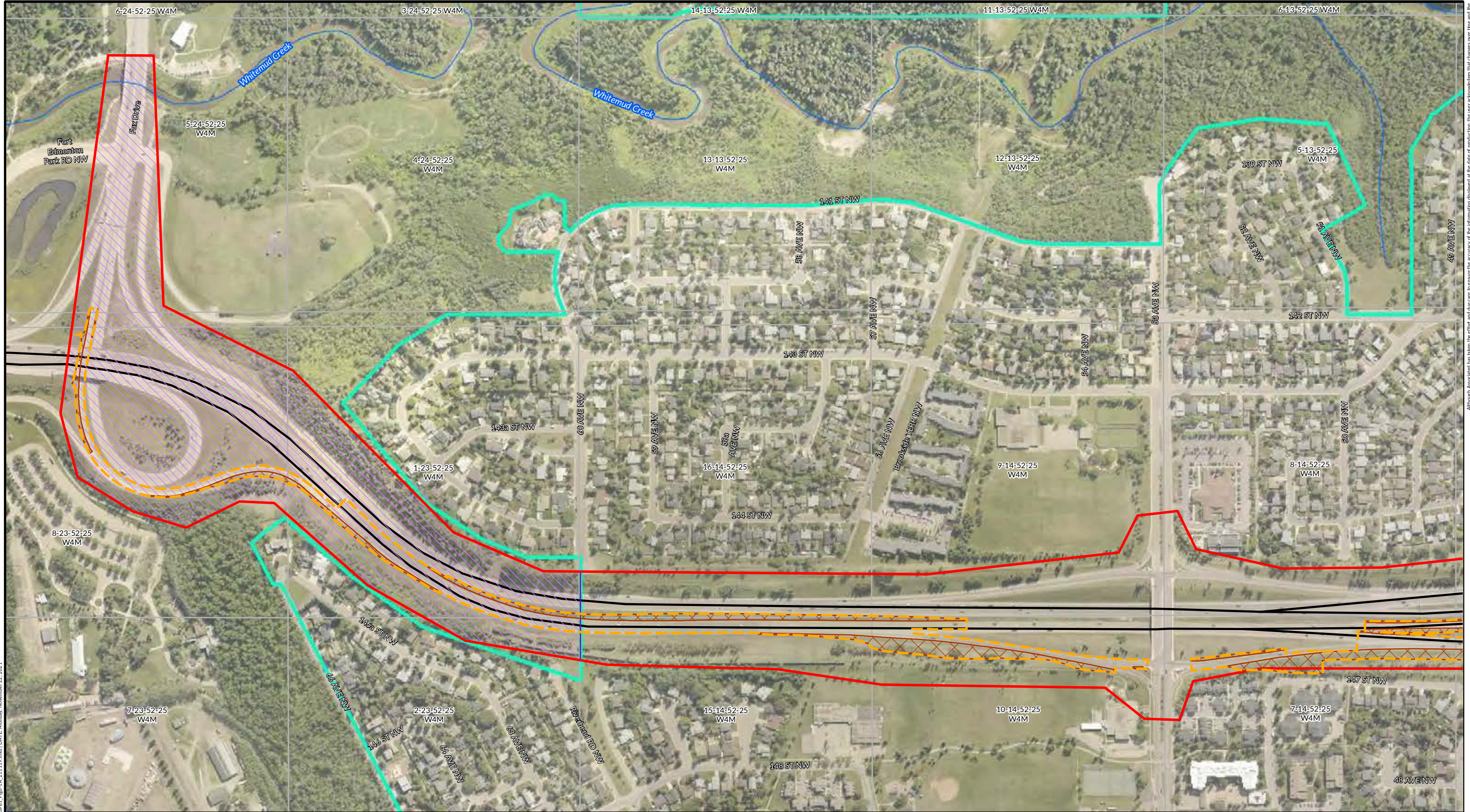

FILE: C:\Users\law\Desktop\Proj\ArcMap\Rev\VAE2021\998L_Fig-1A_211119.mxd [DATE: Monday, November 22, 2021]

Although Associated has taken the effort and expense to ensure the accuracy of the information displayed on this map, the user acknowledges that changes over time and the currency of the datasets may impact the accuracy of the information without notice. Associated shall not be held liable towards the results obtained from the use of this information.



Legend	
	Planned Vegetation Removal
	Project Area
	Study Area
	Water Body
	Watercourse
	NSR Bylaw 7188 Area
	Highway
Base Data	

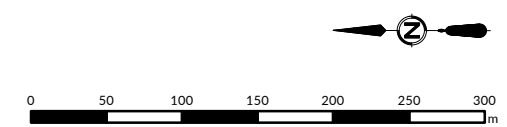

Imagery: Esri, DigitalGlobe, GeoEye, i-cubed, USDA FSA, USGS, AEX, Getmapping, Road: Statistics Canada, 2019; Hydrography: Altalis Ltd., 1996; ATS Grid: Altalis Ltd., 2005; Bylaw 7188 Area: Associated Engineering 2020.

AE PROJECT No.	2021-3981
DATE	2021 NOVEMBER
SCALE	1:5,000
COORD. SYSTEM	NAD 1983 3TM 114
REV	0
DESCRIPTION	ISSUED FOR REPORT
DRAWN BY	WL
CHECKED BY	EC

FIGURE 6-1
Planned Vegetation Removal
And Retention Areas
 TWD Stage 2 Upgrades and
 RVB Renewal and Widening
 Fox Drive Interchange
 Environmental Impact Assessment

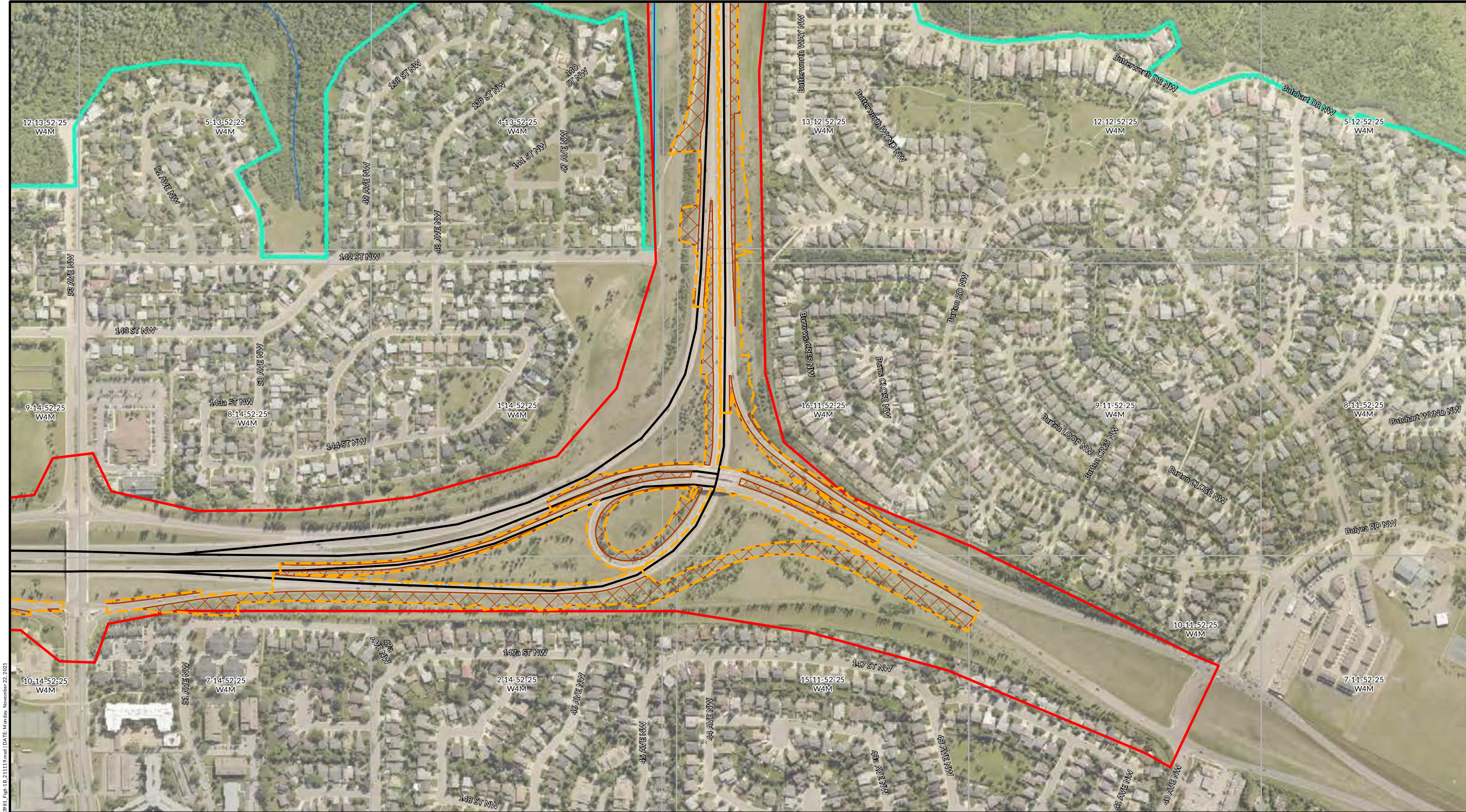

FILE: C:\Users\law\Desktop\Proj\ArcMap\Rev\VAE\2021\9981L_Fig-1B_211117.mxd | DATE: Monday, November 22, 2021



Legend

- Planned Vegetation Removal
- Project Area
- Study Area
- Watercourse
- NSR Bylaw 7188 Area
- Water Body

Base Data

- Highway

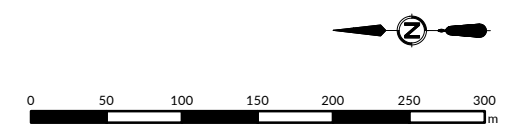

Imagery: Esri, DigitalGlobe, GeoEye, i-cubed, USDA FSA, USGS, AEX, Getmapping, Road, Statistics Canada, 2019; Hydrography: Altalis Ltd., 1996; ATIS Grid: Altalis Ltd., 2005; Bylaw 7188 Area: Associated Engineering 2020.

AE PROJECT No.	2021-3981
DATE	2021 NOVEMBER
SCALE	1:5,000
COORD. SYSTEM	NAD 1983 3TM 114
REV	0
DESCRIPTION	ISSUED FOR REPORT
DRAWN BY	WL
CHECKED BY	EC

FIGURE 6-2
Planned Vegetation Removal
And Retention Areas

TWD Stage 2 Upgrades and
RVB Renewal and Widening
Fox Drive Interchange

Environmental Impact Assessment

Although Associated has taken the effort and expense to prepare this information, it provides the user with the accuracy of the information displayed. The user acknowledges that changes over time and the currency of the datasets may impact the accuracy of the information without notice. Associated shall not be held liable towards the results obtained from the use of this information.

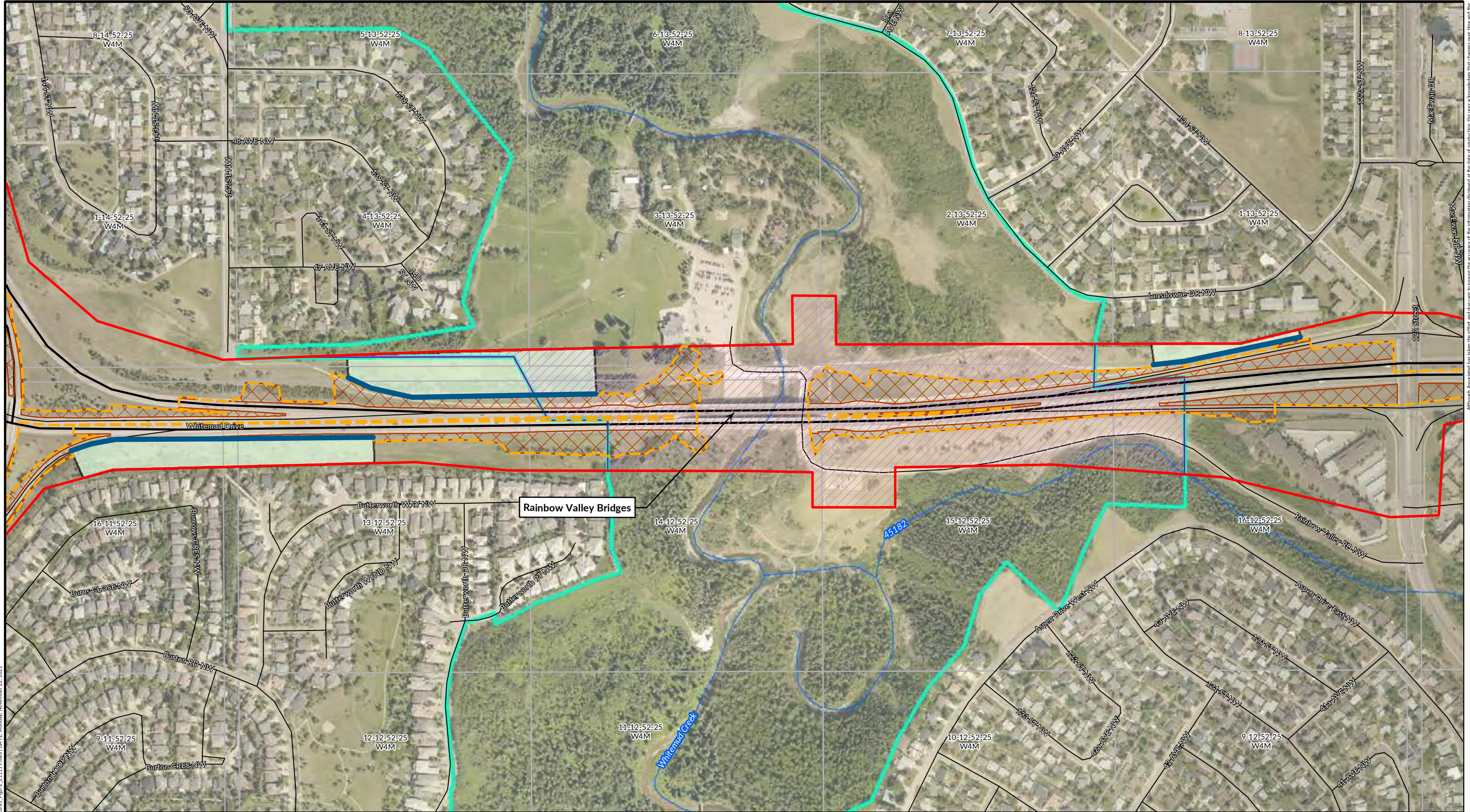

FILE: C:\Users\law\Desktop\Proj\Arch\Map\Rev\VAE\2021\9981L_Figs\2_211119.mxd | DATE: Monday, November 22, 2021

Although Associated has taken the effect and due care to ensure the accuracy of the information displayed on this map, the user acknowledges that changes over time and the currency of the datasets may impact the accuracy of the information without notice. Associated shall not be held liable towards the results obtained from the use of this information.



Legend	
	Planned Retaining Wall
	Planned Vegetation Removal
	Planned Vegetation Retention
	Project Area
	Study Area
	Highway
	Watercourse
	NSR Bylaw 7188 Area
Base Data	

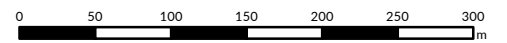

AE PROJECT No.	2021-3981
DATE	2021 NOVEMBER
SCALE	1:5,000
COORD. SYSTEM	NAD 1983 3TM 114
REV	0
DESCRIPTION	ISSUED FOR REPORT
DRAWN BY	WL
CHECKED BY	EC

FIGURE 6-3
Planned Vegetation Removal
And Retention Areas

TWD Stage 2 Upgrades and
 RVB Renewal and Widening
 Rainbow Valley Bridges

Environmental Impact Assessment

6.3 Mitigation Measures

Overall, environmental impacts can be mitigated by reducing the footprint of infrastructure and the spatial extent and duration of construction. Therefore, opportunities for mitigating environmental impacts by minimizing the permanent infrastructure footprint and extent and duration of construction should be considered throughout detailed design and construction.

Specific mitigation measures addressing the anticipated or potential environmental impacts identified previously are outlined in **Table 6-7**. Mitigation measures identified under planning and design are the responsibility of the design consultants and Project Managers. The remainder of mitigation measures are required to be implemented at the construction phase of the project and are the responsibility of the contractor.

With the addition of the new 5 m wide pedestrian bridge and the extension of the eastbound and westbound bridges, the length of the wildlife passage will increase from 36 m to approximately 58 m. Wildlife crossing will be most limited by the open spaces beneath the extended bridges and the cross-sectional areas of these open spaces will change minimally due to the new crossfall of the bridges. Therefore, openness ratios of the four open spaces beneath the extended bridges and new pedestrian bridge become 6.0, 12.8, 10.7, and 5.0, from east to west, respectively. These openness ratios are still well above the minimum ratio of 1.5 that is required for large terrestrial mammals (City of Edmonton 2010) and wildlife are not likely to be inhibited by the lack of openness beneath the bridges.

Prior to the start of construction, the contractor will be required to develop an ECO Plan that is specific to the project. This ECO Plan is to be reviewed and accepted prior to the commencement of construction activities. The contractor's ECO Plan is to be developed in accordance with the most recent version of the ECO Plan Framework prepared by the City of Calgary and City of Edmonton (2020). In addition, the contractor is to include an Erosion and Sediment Control (ESC) Plan, that follows the City of Edmonton Erosion and Sediment Control Guidelines (City of Edmonton 2005) and is endorsed by a Certified Professional Erosion and Sediment Control (CPESC) specialist, as part of the ECO Plan. Finally, the development of a Tree Preservation Plan will be required in accordance with the City of Edmonton Corporate Tree Management Policy. The contractor will be required to develop a Tree Preservation Plan that is approved through Natural Areas Operations and Urban Forestry.

Effective implementation of mitigation measures requires planning, communication, and coordination among the project owners, the consultant, and the contractor awarded the project. The environmental mitigation measures in this Environmental Impact Assessment, regulatory permits, and other project documents are to be included in regular project meetings.

**Table 6-7
Mitigation Measures to Address Environmental Impacts of the Project**

Ecosystem Component	Environmental Impact	Mitigation Measures for Planning and Design Phase	Mandatory Mitigation Measures for Construction Phase
Groundwater – Exposed groundwater from construction excavations	Excess withdrawal of groundwater from construction dewatering activities.	<ul style="list-style-type: none"> • Not applicable. 	<ul style="list-style-type: none"> • Inform Project Management Team if construction dewatering is anticipated to be required for greater than 6 months as a Temporary Diversion Licence would be required.
Groundwater – Exposed groundwater from construction excavations	Contamination of groundwater within excavations from construction materials.	<ul style="list-style-type: none"> • Not applicable. 	<ul style="list-style-type: none"> • Include material storage and handling practices in the project specific ECO Plan with awareness that groundwater in open excavation may be an important environmental sensitivity.
Groundwater – Exposed groundwater from construction excavations	Contamination of groundwater within excavations from previously contaminated soils.	<ul style="list-style-type: none"> • Not applicable. 	<ul style="list-style-type: none"> • Where present, remove all debris prior to any excavation work. • Assess any soils encountered during ground disturbance with indications of potential contamination (e.g., odours, staining, or sheen) for PCOCs. These soils may need to be managed.
Surface Water – Stormwater runoff	Changes to local hydrology patterns and increased impervious surface causing increased amount of stormwater drainage.	<ul style="list-style-type: none"> • Consider the volume and rate of stormwater runoff that will be directed into the surrounding areas from the development of the project and incorporate grading and permanent erosion and sediment control (ESC) measures into design of the project. 	<ul style="list-style-type: none"> • Include temporary ESC measures in the project specific ECO Plan to control the volume and/or rate of water runoff from the construction area.
Surface Water – Bed and banks of Whitemud Creek	Erosion of downstream bed and banks due to changes in flow/velocity as a result of instream isolation.	<ul style="list-style-type: none"> • Consider the volume and rate of water that will be directed around instream isolation and include ESC measures in detailed design, as needed to prevent downstream erosion during isolation. 	<ul style="list-style-type: none"> • Include temporary ESC measures in the project-specific ECO Plan to control the volume and/or rate of water diverted around the construction area.

Ecosystem Component	Environmental Impact	Mitigation Measures for Planning and Design Phase	Mandatory Mitigation Measures for Construction Phase
Surface Water – Water quality in Whitemud Creek	Sedimentation of the Whitemud Creek from instream works to install bridge piers and/or erosion of bare soil during construction.	<ul style="list-style-type: none"> • Develop recommendations from a Qualified Aquatic Environment Specialist (QAES) in <i>Fisheries Act</i> and <i>Water Act</i> regulatory applications and design of the proposed footbridge. • Develop a restoration plan for vegetated areas temporarily disturbed by construction. • Incorporate permanent ESC measures into design of the proposed footbridge. • Retain a qualified professional to develop a water quality monitoring plan to follow the Alberta Environmental Quality Guidelines for Alberta Surface Water 	<ul style="list-style-type: none"> • Follow recommendations for instream work made by QAES in <i>Fisheries Act</i> and <i>Water Act</i> regulatory permits. • Minimize the extent and duration of soil exposure, especially during periods when the ground is not frozen. • Include an ESC Plan in the project-specific ECO Plan. • Install and maintain appropriate ESC measures throughout construction with attention to the North Saskatchewan River as an important environmental sensitivity. • Retain a qualified professional to complete water quality monitoring as per the water quality monitoring plan.
Surface Water and Fish Habitat – Whitemud Creek	Contamination of Whitemud Creek from materials used during the construction.	<ul style="list-style-type: none"> • Require the contractor to develop and implement an ESC Plan as per the City of Edmonton Erosion and Sedimentation Control Guidelines (2005). • Retain a qualified professional to develop a water quality monitoring plan to follow the Alberta Environmental Quality Guidelines for Alberta Surface Water 	<ul style="list-style-type: none"> • Include material storage and handling practices in the project-specific ECO Plan with awareness that groundwater in open excavation may be an important environmental sensitivity. • Avoid use of hazardous substances near to unnamed watercourse or existing catch basins. • Avoid refuelling or equipment repairs or maintenance near to unnamed watercourse or existing catch basins. • Use double-containment for hazardous material storage. • Install drip trays beneath stationary equipment. • Perform routine inspection of equipment and construction area to ensure equipment is in good working condition and hazardous materials are contained and stored adequately.

Ecosystem Component	Environmental Impact	Mitigation Measures for Planning and Design Phase	Mandatory Mitigation Measures for Construction Phase
Fish Habitat – Aquatic habitat in Whitemud Creek	Temporary isolation installed in water resulting in the temporary loss and alteration of fish habitat.	<ul style="list-style-type: none"> • Develop recommendations made by a QAES. • Minimize instream footprint of isolation wherever possible. 	<ul style="list-style-type: none"> • Avoid operation of equipment or machinery below the high-water mark. Equip machinery or equipment operating below the high-water mark with biodegradable hydraulic fluids. • Prepare a Spill Response Plan. Ensure all crew members and sub-consultants have reviewed the plan and are trained in the use of spill prevention and clean-up materials and procedures. • Follow recommendations for instream work made by a QAES. • Minimize duration and extent of instream berms, where possible. • Implement DFO’s measures to avoid harm to fish and fish habitat, where applicable. • Ensure installation and removal of isolation is completed outside of the RAP for the river. • Complete a fish rescue after the construction of isolation berms within the isolated areas. A fish rescue must be completed after isolation measures are installed but prior to instream works commencing. • Utilize a QAES to complete the fish rescue and ensure they are applying best practices and following the conditions/requirements outlined in the FRL.
Fish – Fish inhabiting Whitemud Creek and the Unnamed tributary	Increased sedimentation of fish habitat.	<ul style="list-style-type: none"> • Develop recommendations made by a QAES. • Retain a qualified professional to develop a water quality monitoring plan to follow the Alberta Environmental Quality Guidelines for Alberta Surface Water • Require the contractor to develop and implement an ESC 	<ul style="list-style-type: none"> • Follow recommendations for instream work made by a QAES. • Retain a qualified professional to complete water quality monitoring as per the water quality monitoring plan. • Dewater sediment-laden water within isolated areas to a well vegetated area to promote sediment filtration prior to re-entry to Whitemud Creek. Other methods of sediment filtration (e.g., silt bag) may also

Ecosystem Component	Environmental Impact	Mitigation Measures for Planning and Design Phase	Mandatory Mitigation Measures for Construction Phase
		Plan as per the City of Edmonton Erosion and Sedimentation Control Guidelines (2005).	be suitable to prevent the release of sediment-laden water.
Fish – Fish inhabiting Whitemud Creek	Death or injury to fish during the fish rescue for instream work.	<ul style="list-style-type: none"> Develop recommendations made by a QAES. 	<ul style="list-style-type: none"> Follow recommendations for instream work made by a QAES. Obtain a fish research license (FRL) to complete the fish rescue. Utilize a QAES to complete the fish rescue.
Fish – Fish inhabiting Whitemud Creek and the Unnamed tributary	Sensory disturbance to fish.	<ul style="list-style-type: none"> Develop recommendations made by a QAES. 	<ul style="list-style-type: none"> Follow recommendations for instream work made by a QAES. Minimize the duration of construction where possible.
Fish – Fish inhabiting Whitemud Creek and the Unnamed tributary	Spread of whirling disease and/or invasive species	<ul style="list-style-type: none"> Develop recommendations made by a QAES. 	<ul style="list-style-type: none"> Follow recommendations for instream work made by a QAES. Clean, drain, disinfect, and dry all equipment and machinery operating below the high-water mark following the Government of Alberta (2021g) Equipment Decontamination Protocols, to prevent the potential introduction of invasive species and whirling disease.
Soils – Areas of native soil	Removal and replacement of native topsoil with non-native fill or use of imported topsoil for restoration	<ul style="list-style-type: none"> Include the salvage and storage of native, non-contaminated topsoil in the restoration plan. All imported topsoil must be deemed acceptable with no contamination. 	<ul style="list-style-type: none"> Strip and stockpile native topsoil separate from other materials. Store topsoil on relatively flat terrain and a minimum of 30 m from Whitemud Creek. Install adequate ESC measures to prevent erosion and loss of native topsoil from stockpile(s).
Soils – Areas of native soil or fill	Contamination of soils from spills of construction materials or equipment leaks.	<ul style="list-style-type: none"> Not applicable. 	<ul style="list-style-type: none"> Include material storage and handling practices in the project-specific ECO Plan with awareness that groundwater in open excavation may be an important environmental sensitivity. Use double-containment for hazardous material storage.

Ecosystem Component	Environmental Impact	Mitigation Measures for Planning and Design Phase	Mandatory Mitigation Measures for Construction Phase
Soils – Exposed soils during construction phase, specially during unfrozen conditions	Erosion of exposed soil resulting in loss of material.	<ul style="list-style-type: none"> • Not applicable. 	<ul style="list-style-type: none"> • Install drip trays beneath stationary equipment. • Minimize the extent and duration of soil exposure, especially during periods when the ground is not frozen. • Include an ESC Plan in the project-specific ECO Plan. • Install and maintain appropriate ESC measures throughout construction with attention to areas of exposed soil as well as stockpiled materials.
Soils – Areas of contaminated soils exposed during construction	Exposure of contaminated soils to precipitation can cause the contamination of surface water	<ul style="list-style-type: none"> • Not applicable 	<ul style="list-style-type: none"> • Remove all debris from the site prior to any excavation work. • Assess any soils encountered during ground disturbance with indications of potential contamination (e.g., odours, staining, or sheen) for PCOCs. These soils may need to be managed.
Vegetation – Native plants in vegetated areas	Temporary and permanent loss of native plants and vegetation structure in the study area from removal of vegetation.	<ul style="list-style-type: none"> • Minimize extent of infrastructure within forested areas, as much as possible. • Design retaining walls to avoid unnecessary vegetation clearing and grading. • Coordinate with Natural Areas Operations and Urban Forestry regarding vegetation removals to support construction and operation of the project. • Develop a restoration plan in detailed design that includes revegetation with native species to restore vegetated areas that are disturbed through construction. • Require contractor to complete a Tree Preservation Plan for the 	<ul style="list-style-type: none"> • Install physical markers to delineate the construction limits and avoid over clearing of vegetation. • On City lands, ensure vegetation removal is only completed by contractors under the direction of Natural Areas Operations. • Require contractor to implement the Tree Preservation Plan for the project and obtain Tree Permit under Public Tree Bylaw 18825. • Implement the restoration plan as soon as possible following construction to encourage the establishment of vegetation as soon as possible.

Ecosystem Component	Environmental Impact	Mitigation Measures for Planning and Design Phase	Mandatory Mitigation Measures for Construction Phase
Vegetation – Landscaped vegetation in the study area	Removal and damage of landscaped vegetation, including trees, shrubs, and maintained grass from construction activities.	<p>project and obtain a Tree Permit under Public Tree Bylaw 18825.</p> <ul style="list-style-type: none"> • Include landscaped trees in detailed design and avoid conflicts with these trees. • Require contractor to include tree protection for landscaped trees as part of the Tree Preservation Plan. • Develop a restoration plan in detailed design that includes revegetation with native species to restore vegetated areas that are disturbed through construction. The plan is intended to replace the total asset value of trees removed during construction. • Coordinate with the City’s Urban Forestry and Parks and Landscape groups regarding removal of landscaped vegetation needed to support construction and operation of the project. 	<ul style="list-style-type: none"> • Include landscaped trees in the project-specific Tree Preservation Plan. • On City lands, ensure vegetation removal is only completed by contractors under the direction of members from Urban Forestry and/or Parks and Landscape. • Implement the restoration plan as soon as possible following construction to encourage the establishment of vegetation as soon as possible.
Vegetation – Existing populations of weeds and non-native plants	Introduction and/or spread of weed populations and non-native plants	<ul style="list-style-type: none"> • Use native species in restoration plan. 	<ul style="list-style-type: none"> • Clean equipment prior to arrival on site and after completion of work before equipment is moved to new location. • Delineate areas of weed infestation and avoid the use of machinery in these areas if possible. • Control noxious weeds in construction area through mechanical means such as hand pulling.

Ecosystem Component	Environmental Impact	Mitigation Measures for Planning and Design Phase	Mandatory Mitigation Measures for Construction Phase
Vegetation – Existing populations of rare plants	Accidental destruction of rare plants	<ul style="list-style-type: none"> • Not applicable 	<ul style="list-style-type: none"> • Avoid areas designated as having an elemental or non-elemental occurrence in the construction area. • If a rare plant is identified during construction, inform the Project Management Team as additional protections or translocation of the plant may be required.
Wildlife – Wildlife passage and habitat connectivity	Restriction of wildlife movement between habitats in the Whitemud Ravine at operational stage of rehabilitated bridges and new pedestrian / cyclist bridge.	<ul style="list-style-type: none"> • Minimize extent of riprap, in wildlife passage spaces of bridges. • Develop a restoration plan in detailed design that includes revegetation of habitats within the area that are temporarily disturbed. 	<ul style="list-style-type: none"> • Not applicable.
Wildlife – Wildlife passage and habitat connectivity	Restriction of wildlife movement between habitats in the Whitemud Ravine and the North Saskatchewan River valley during construction.	<ul style="list-style-type: none"> • Design wildlife passages according to the Wildlife Passage Engineering Design Guidelines (Appendix B). 	<ul style="list-style-type: none"> • Accommodate access through or around construction area for passage of medium to large mammals.
Wildlife – Bird nesting habitat within the native or landscaped vegetation	Temporary or permanent loss of bird nesting habitat from vegetation removal to support construction and operation.	<ul style="list-style-type: none"> • Plan for removal of vegetation outside of the general bird nesting period of mid February to late August. • Coordinate with Natural Areas Operations and Urban Forestry for vegetation removal on City lands. • Develop a restoration plan that includes revegetation with native species to restore areas 	<ul style="list-style-type: none"> • Coordinate with Project Management Team to ensure that the removal of vegetation is completed prior to construction activities. • Install physical markers to delineate the construction limits and avoid over clearing into potential bird nesting habitat.

Ecosystem Component	Environmental Impact	Mitigation Measures for Planning and Design Phase	Mandatory Mitigation Measures for Construction Phase
		that are disturbed through construction.	
Wildlife – Actively nesting birds within or adjacent to construction limits	Incidental take of active bird nests from construction activities.	<ul style="list-style-type: none"> Plan for removal of vegetation outside of the general bird nesting period of mid February to late August. 	<ul style="list-style-type: none"> Coordinate with Project Management Team to ensure that the removal of vegetation is completed prior to construction activities. For vegetation removal within the general bird nesting period of mid February to late August, complete a pre-construction nest sweep.
Wildlife – Sensory perceptions of individuals using habitats near construction	Interference of hearing or sight from construction noise or use of artificial lighting during construction and operation.	<ul style="list-style-type: none"> Include lights with low lumen output and dim the luminaire output, as needed. Note that current lights are to be 34 W luminaires dimmed to 31% of their output. Design lights with a type IV light distribution to minimize potential light spilling into the surrounding area. 	<ul style="list-style-type: none"> Limit construction activity to a timeframe between 7 a.m. and 9 p.m. Direct any construction lighting towards construction area and avoid the project of light out into the surrounding area. Keep construction area clean of garbage and waste and avoid feeding or harassment of wildlife.
Historical Resources – Potentially undiscovered archaeological, palaeontological, and/or provincially designated historic resources and/or Indigenous traditional use sites within study areas	Disturbance of unanticipated historic resource through ground disturbance activities during construction.	<ul style="list-style-type: none"> Amend the <i>Historical Resources Act</i> approval if footprint changes during the design phase of the project. Require that a qualified professional is retained to complete paleontological monitoring in areas of significant ground disturbance. 	<ul style="list-style-type: none"> Stop work and inform Project Management Team of discoveries of potential historical resources. Report discovery of potential historical resources to Alberta Culture, Multiculturalism and Status of Women. Have a qualified professional present to complete paleontological monitoring in areas of significant ground disturbance.
Contamination – Existing wastes or debris in construction area	Deposition of wastes into excavations or Whitemud Creek during construction activities.	<ul style="list-style-type: none"> Check contaminated site reports for recommendations. 	<ul style="list-style-type: none"> Check contaminated site reports for recommendations.

Ecosystem Component	Environmental Impact	Mitigation Measures for Planning and Design Phase	Mandatory Mitigation Measures for Construction Phase
Contamination – Salinity impacted soils	Transfer of soils with high salinity to locations outside of the project area resulting in salinity impacts to soil and water elsewhere.	<ul style="list-style-type: none"> • Check contaminated site reports for recommendations. 	<ul style="list-style-type: none"> • Follow all mitigation measures provided in the project specific CSMS (Appendix E).
Contamination –Soils potentially containing chemicals commonly found within firefighting foams at site of former diesel spill	Transfer of chemicals to locations outside of the project area resulting in impacts to soil and water elsewhere.	<ul style="list-style-type: none"> • Check contaminated site reports for recommendations. 	<ul style="list-style-type: none"> • Check contaminated site reports for recommendations.

7 ENVIRONMENTAL MONITORING

Routine environmental site inspections (e.g., weekly) should be completed by the contractor throughout the construction phase to confirm project compliance and that activities are following the ECO Plan. An environmental monitor should be retained before the project is initiated to monitor site preparation and construction activities. The environmental monitor may be associated with the contractor such that they ensure compliance. The monitor will be required to:

- Complete nesting and rare species surveys prior to site clearing, as required;
- Provide, initiate, and guide the implementation of the mitigation strategies discussed in the project ECO and ESC Plans;
- Inspect ESC devices prior to ground disturbance and during periods of high precipitation;
- Monitor wildlife access through the construction area;
- Monitor weather conditions and prepare contingency measures for flood events in Whitemud Creek that may reach elevations at or above the limit of construction;
- Monitor turbidity in Whitemud Creek during all instream work according to the Alberta Surface Water Quality Guidelines (Government of Alberta 2018);
- Document and photograph progress of site preparation and construction; and
- Report any non-compliances or wildlife encounters to the Contractor Representative and the City of Edmonton.

Following construction, the contractor shall adhere to any monitoring requirements in the contract to ensure that final acceptance criteria are met.

As per the Historical Resources Impact Assessment report, a qualified professional with a valid permit is required to be on-site during significant ground disturbance activities to complete monitoring for potential paleontological resources.

8 PUBLIC CONSULTATION

The public and stakeholder engagement process will create opportunities for area residents, communities, organizations, businesses, commuters, and stakeholders to learn the reason for the project, the stage of the project, and its scope.

At the Preliminary Design Phase, there is an opportunity to tap into local knowledge to discuss detouring, and construction scheduling, as well as to gather final input to consider as the design is finalized. This also presents the opportunity to keep citizens, including businesses, commuters, and stakeholders informed throughout the duration of the project.

The Decision Map indicates that limited public and stakeholder engagement is needed due to the stage of the project as decisions are predominantly technical at the Preliminary Design phase.

The City has determined that it would like to achieve five goals as they relate to the project.

- Build support and understanding for the project and trusting relationships.
- Ensure the program displays mutual respect and benefit, ensuring participants feel safe, respected and heard.
- Ensure that the program is inclusive and accessible, capturing input from a diverse range of people.
- Ensure the program is effective, well designed and transparent, with participants understanding how their input is being collected and how it was used to inform the decisions being made.
- Engage with local area residents to determine the appetite for noise walls along Whitemud Drive.

As design progresses further public consultation will be completed. Tree removal and tree replacement information will be shared with the public in multiple formats including website updates, E-newsletter, pre- construction bulletins, and public engagement open houses. Information about construction plans and environmental impacts will be made available for comment and input.

9 CONCLUSIONS AND SUPPORTING INFORMATION

Terwillegar Drive, in Edmonton, Alberta, is a road connecting Whitemud Drive to Anthony Henday Drive and ultimately south to Highway 19. The roadway was originally envisioned to be a freeway facility to improve movement around the city. The City is advancing an integrated, multi-modal expansion plan in 3 stages. The City has engaged CIMA+ as prime consultant for the Preliminary Design and Delivery of Stage 2, with Associated Engineering as sub-consultant for the structures, including:

- Rainbow Valley Bridges Rehabilitation and Widening;
- New Pedestrian / Cyclist Bridge over Whitemud Creek;
- Terwillegar Drive / Whitemud Drive Interchange;
- 53 Avenue / Terwillegar Drive Bus Only Ramp Retaining Wall;
- 53 Avenue over Whitemud Drive Bridge; and
- Whitemud Drive over Fox Drive Bridge.

Major environmental sensitivities within the project area include Whitemud Creek, an Unnamed waterbody, surrounding vegetation, bird nesting habitat, and historical resources.

During the construction phase, the contractor will be responsible for adhering to general construction mitigation measures. These mitigation measures will be outlined in a project-specific ECO Plan that is accepted by the City of Edmonton. As part of the ECO Plan, the contractor shall be required to develop an ESC Plan that is endorsed by a CPESC. In addition, the contractor is required to develop a Tree Preservation Plan following the City's requirements. The contractor is responsible for routine environmental inspections and maintenance throughout the construction phase of the project.

Provided the contractor follows the mitigation measures provided here and those outlined the ECO Plan, ESC Plan, and restoration plan any negative residual impacts from the project are anticipated to be negligible.

CLOSURE

This report was prepared for the City of Edmonton to support the City Planning Department's environmental review process and ultimately satisfy the requirements of Bylaw 7188.

The services provided by Associated Engineering Alberta Ltd. in the preparation of this report were conducted in a manner consistent with the level of skill ordinarily exercised by members of the profession currently practicing under similar conditions. No other warranty expressed or implied is made.

Respectfully submitted,

Prepared by:



Erin Cawthorn, BIT
Environmental Scientist

EC

Reviewed by:



Brett Bodeux, M.Sc., P.Biol., AIT
Environmental Scientist

BB

REFERENCES

Alberta Environment and Parks (AEP). 2020. Environmental Site Assessment Repository.

Andriashek, L. D., and MacMillan R. A. 1981. Preliminary Report on the Urban Geology of the Annexed Areas in Edmonton, Open File Report 1982-01.

Björk, C. R., and T. Goward. 2010. Epiphytic Crustose Lichens of the Clearwater Valley, British Columbia.

Canadian Navigable Waters Act. R.S., 1985, c. N-22, s. 1; 2012, c. 31, s. 316; 2019, c. 28, s. 46.

City of Edmonton. 2010. Wildlife Passage Engineering Design Guidelines. Prepared for: The City of Edmonton Office of Natural Areas. Prepared by: Stantec Consulting Ltd.

City of Edmonton. 2016a. Environmental Sensitivity Project, Model data. Prepared for: The City of Edmonton, Alberta. Prepared by: Solstice Canada. Edmonton Alberta.

City of Edmonton. 2016b. Urban Primary Land and Vegetation Inventory (uPLVI). Spatial Data. 2015 edition. Prepared for: Parks and Biodiversity Section, Sustainable Development, the City of Edmonton, Alberta. Prepared by: Greenlink Forestry Inc. Edmonton Alberta.

City of Edmonton. 2018. North Saskatchewan River Valley Area Redevelopment Plan, Bylaw 7188.

City of Edmonton. 2019a. Bylaw 2202. Parkland Bylaw. Edmonton, Alberta.

City of Edmonton. 2019b. City of Edmonton Bylaw 18093 Drainage Bylaw.

City of Edmonton. 2019c. Environmental Sensitivities – Score (map).

City of Edmonton. 2020a. Corporate Tree Management Policy C456C.

City of Edmonton. 2020b. City of Edmonton Bylaw 14600 Community Standards Bylaw.

City of Edmonton. 2020c. City of Edmonton Bylaw 18100 EPCOR Drainage Services Bylaw.

City of Edmonton. 2020d. Ribbon of Green. SW + NE.

City of Edmonton. 2021a. City of Edmonton: SLIM Maps. Zoning.

City of Edmonton. 2021b. Edmonton's Ecological Network Map.

City of Edmonton. 2021c. Bylaw 18825 Public Tree Bylaw.

Cornell University. 2019. All About Birds.

Environmental Protection and Enhancement Act. RSA 2000, c. E-12.

Fenton, M. M., Waters, E. J., Pawley, S. M., Atkinson, N., Utting, D. J., and McKay, K. 2013. Surficial Geology of Alberta, Map 601.

Fisheries Act. R.S.C., 1985, c. F-14.

Flora of North America Association. 2014. Flora of North America North of Mexico. Volume 28. Bryophyta, part 1. Oxford University Press.

Flora of North America Association. 2014. Flora of North America North of Mexico. Volume 28. Bryophyta, part 2. Oxford University Press.

Flora of North America Association. 2020. Flora of North America.

Government of Alberta. 2012. Code of Practice for watercourse crossings (map). St. Paul Management Area Map.

Government of Alberta. 2014. Significant Landforms of Alberta Project – an introduction.

Government of Alberta. 2015. Recommended Land Use Guidelines: Key Wildlife and Biodiversity Zones. Wildlife Land Use Guidelines. Environment and Sustainable Resource Development.

Government of Alberta. 2017. Alberta General Species Status Listing – 2015.

Government of Alberta. 2018. Environmental Quality Guidelines for Alberta Surface Waters.

Government of Alberta. 2019. Alberta Conservation Information Management System.

Government of Alberta. 2021a. Agricultural Regions of Alberta Soil Inventory Database (AGRASID).

Government of Alberta. 2021b. Water Well Information Database.

Government of Alberta. 2021c. Flood Hazard Maps. Alberta Floods.

Government of Alberta. 2021d. Fisheries and Wildlife Management Information System (FWMIS).

Government of Alberta. 2021e. Listing of Historical Resources.

Government of Alberta. 2021f. Wildlife Sensitivity Maps.

Government of Alberta. 2021g. Stop the Spread of Whirling Disease.

Government of Canada. 2018. General Nesting Periods of Migratory Birds in Canada. Environment Canada.

Government of Canada. 2021a. Species at Risk Public Registry – Species Search.

- Government of Canada. 2021b. Schedule 1 List of Wildlife Species at Risk.
- Goward, T., B. McCune, and D. Meidinger. 1994. The lichens of British Columbia, illustrated keys. British Columbia Ministry of Forest Research Program.
- Hilty, J. 2020. Illinois Wildflowers.
- Historical Resources Act*. RSA 2000, c H-9.
- Kathol, C. P., and McPherson, R. A. 1975. Urban Geology of Edmonton, Bulletin 032.
- Migratory Birds Convention Act*. SC 1994, c. 22.
- Minnesota Wildflowers. 2021. A Field Guide to the Flora of Minnesota – Flat-topped White Aster.
- Natural Regions Committee. 2006. Natural Regions and Subregions of Alberta.
- Pedocan Land Evaluation Ltd. 1993. Soil Series Information for Reclamation Planning in Alberta. Reclamation research technical advisory committee.
- Prior, G. J., Hathaway, B., Glombick, P.M., Pana, D.I., Banks, C.J., Hay, D.C., Schneider, C.L., Grobe, M., Elgr, R., and Weiss, J.A. 2013. Bedrock Geology of Alberta. Alberta Geological Survey, Map 600.
- Public Lands Act*. P-40 RSA 2000.
- Soil Conservation Act*. RSA 2000, c. S-15.
- Species at Risk Act*. SC 2002, c. 29.
- Stavne, R.B. 2006. Sharp-tailed grouse lek surveys, northwestern Alberta, 2005. Data Report, D-2006-011. Alberta Conservation Association, Peace River, Alberta.
- Thurber Engineering Ltd. (Thurber). 2021a. Terwillegar Drive Stage 2 Rainbow Valley Bridge Widening Edmonton, Alberta. Geotechnical investigation and geotechnical assessment of bridge foundations. 56pgs. File: 30442. DRAFT.
- Thurber Engineering Ltd. (Thurber). 2021b. Terwillegar Drive and Whitemud Drive, Terwillegar Drive Stage 2. Interim report for interchange retaining wall and embankment recommendations. 178 pgs. File: 30442. DRAFT.
- Thurber Engineering Ltd. (Thurber). 2021c. Geotechnical Assessment and Preliminary Recommendations for Retaining Walls East of Terwillegar Drive and South of Whitemud Drive, Terwillegar Drive Upgrading – Stage 2. 75 pgs. File: 30442. DRAFT.
- Water Act*. RSA 2000, c. W-3.

Weed Control Act. RSA 2008, c. W-5.1.

Weed Control Regulation. Alberta Reg. 19/2010.

Wildlife Act. RSA 2000, c. W-10.

Wildlife Act: Wildlife Regulation. Alberta Regulation 143/1997.

Wisconsin Department of Natural Resources. 2021. Common Antler Lichen (*Pseudevernia consocians*) – Life History.

APPENDIX A – HISTORICAL RESOURCES OVERVIEW REPORT, HISTORICAL RESOURCES IMPACT ASSESSMENT, AND APPROVAL



Heritage &
Archaeology
Consulting

Calgary Head Office
60, 4807 32 St. SE
Calgary, AB T2B 2X3
TEL: 403 984 8189
info@circleconsulting.ca
www.circleconsulting.ca

Edmonton Office
210, 10544 106 St. NW
Edmonton, AB T5H 2X6
TEL: 780 423 5840
info@circleconsulting.ca
www.circleconsulting.ca

Williams Lake Office
24, 605 Carson Drive
Williams Lake, BC V2G 1T7
TEL: 250 413 7092
info@circleconsulting.ca
www.circleconsulting.ca

MEMO

Date: March 11, 2020
To: Brett Bodeux
Associated Engineering Alberta Ltd.
From: Kristin McKay
Circle CRM Group Inc.
Project: **City of Edmonton**
Rainbow Valley Bridge Renewal & Widening and Terwillegar Drive Stage 2
Upgrades
Subject: **Historic Resources**

As requested, please find below requested information with regard to historic resources for the above-noted project.

1.0 Scope

The City of Edmonton is in the process of concept level planning for road upgrades and bridge widening of Terwillegar Drive, Whitemud Drive and the Rainbow Valley Bridge (the Project). The Project encompasses Whitemud Drive from the Whitemud/Fox Drive interchange south to the Whitemud/Terwillegar Drive interchange then east to the Whitemud Drive/122 Street intersection. Also included is Terwillegar Drive from the Whitemud/Terwillegar Drive interchange south to the Terwillegar Drive/40th Avenue intersection. While the project plans have yet to be finalized, the Project is within a variable width right-of-way of approximately 100 to 200-m wide, with additional width at the interchanges of Whitemud Drive with Fox Drive and Whitemud Drive with Terwillegar Drive.

Historic Resources work is generally undertaken in two phases. **Phase 1** consists of a desktop assessment to identify areas of high archaeological potential. The deliverable is an Historic Resources Application resulting in either *Historical Resources Act* Approval or a *Historical Resources Act* Requirements for completion of a Historical Resources Impact Assessment (HRIA) and/or a palaeontological Historical Resources Impact Assessment (pHRIA). **Phase 2** is triggered if HRIA/pHRIA is required.

Preliminary analysis shows that Project lands have been assigned a Historic Resource Value (HRV) of 4 for palaeontology (Outfall 3 Quaternary Shellbed (Of1), 5 for archaeology (High Archaeological Resource Sensitivity Zone and proximity to known HRV 4 sites FiPj-3, FiPj-22 and FjPj-119), and 5 for palaeontology (High Palaeontological Resource Sensitivity Zone) (October 2019). There are no known archaeology sites within the Project; however, there are 16 known sites within 1 km of the Project. Of these, three are significant HRV 4 sites (FiPj-3, FiPj-22 and FjPj-119) which are removed from the Project by a minimum of 300-m; the remaining 13 sites are of low significance (HRV 0).



The portion of the Project that encompasses Whitemud Drive has its northern terminus at the Whitemud/Fox Drive interchange, which occurs on a lower river terrace on the south side of the North Saskatchewan River. The Project then traverses up the valley slope to the south and crosses the valley rim to flatter terrain where it turns east at the Whitemud/Terwilliger Drive interchange and continues across generally flat terrain before crossing the upper rim of the Whitemud Creek valley, descends down the western wall of the creek valley, crosses the creek (Rainbow Valley bridge) and ascends up the eastern creek wall, crosses the upper rim and traverses generally flat terrain to the eastern project terminus. The portion of the Project that encompasses Terwilliger Drive is situated on generally flat terrain from the Whitemud/Terwilliger Drive interchange south to the southern project terminus at the Terwilliger/40th Avenue intersection.

Review of NTS maps, satellite imagery (ESRI World Imagery) and LiDAR (courtesy of Genesis) shows the Project occurs within lands previously disturbed by Terwilliger Drive, Whitemud Drive, the Rainbow Valley bridge, various smaller roads and associated infrastructure. Given the Project traverses the river floodplain and Whitemud Creek, there is moderate to high potential for deeply buried cultural deposits below any surface disturbances. Depending upon the final project footprint and depth of current and anticipated disturbances, *Historical Resources Act* Requirements for a Historical Resources Impact Assessment (HRIA) and/or a palaeontological Historical Resources Impact Assessment (pHRIA) may be issued for the Project.

2.0 Historic Resources Application

Requirements for a HR Application are set by Alberta Culture, Multiculturalism and Status of Women (ACMSW), and include submission of project plans and illustrative material showing development in association with previously recorded historic resource sites. While not required, Circle also submits a cover letter that notes potential to impact historic resources, with recommendations for either *Historical Resources Act* approval or further work. This recommendation assesses landscape and environmental information, as well as the extent of disturbance (both existing and proposed) and the anticipated impact to known historic resources.

3.0 Historical Resources Impact Assessment (Archaeology)

If the Historic Resources Application results in requirements for an HRIA, the HRIA will focus on the discovery of archaeological and historic sites within the project areas, employing traditional techniques of archaeological survey. This will include pedestrian reconnaissance and shovel testing of high and moderate potential zones identified during the pre-field research.

HRIA target areas will be subject to pedestrian reconnaissance and subsurface testing where lands are deemed to be of moderate to high historic resource potential. Any sites will be reported to the client with recommendations for management and/or mitigation, which will be included in the interim report (if necessary) and/or final report to ACMSW.

All methods incorporate, and are in accordance with, the Guidelines for Archaeological Permit Holders in Alberta, the Archaeological and Palaeontological Research Permit Regulation (Alberta



Regulation 254/2002) and the *Historical Resources Act*, as well as any subsequent *Historical Resources Act* Requirements issued by ACMSW.

4.0 Historical Resources Impact Assessment (Palaeontology)

Depending on the depth and extent of disturbance, a palaeontological HRIA (pHRIA) may be required. A pHRIA may entail a pre-construction site visit, or a construction monitoring program. Both will target any excavation deeper than 1 m, with exposures of bedrock or glacial deposits examined for fossils and the stratigraphy and lithology noted and photographed. During construction monitoring, spoil piles of excavated material will also be examined for lithology and fossils. Samples of any significant fossils found during the project will be collected, while common or poorly preserved fossils will be noted and photographed but not collected.

All methods incorporate, and are in accordance with, the Archaeological and Palaeontological Research Permit Regulation (Alberta Regulation 254/2002) and the *Historical Resources Act*, as well as any subsequent *Historical Resources Act* Requirements issued by ACMSW.

Historical Resources Act Requirements

Proponent: City of Edmonton
12th Floor, Edmonton Tower, 10111 - 104 Avenue NW, Edmonton, AB T5J 0J4

Contact: Christopher Wintle

Agent: Circle CRM Group
Contact: Shannon Wright

**Project Name: Terwillegar Drive Stage 2 - Rainbow Valley Bridges Renewal and Widening
Whitemud Drive and Terwillegar Drive Interchange Upgrades
Whitemud Drive Upgrades Between Fox Drive and 122 Street**

Project Components: Municipal Road
Bridge

Application Purpose: Requesting HRA Approval / Requirements

Pursuant to Section 37(2) of the *Historical Resources Act*, a Historic Resources Impact Assessment is required for all or portions of those activities described in this application and its attached plan(s)/sketch(es). The Historic Resources Impact Assessment is to be conducted in accordance with the instructions outlined in the following schedule.



David Link
Assistant Deputy Minister
Heritage Division
Alberta Culture, Multiculturalism
and Status of Women

SCHEDULE OF REQUIREMENTS

ARCHAEOLOGICAL RESOURCES

There are no *Historical Resources Act* requirements associated with archaeological resources; however, the proponent must comply with [Standard Requirements under the Historical Resources Act: Reporting the Discovery of Historic Resources](#), which are applicable to all land surface disturbance activities in the Province.

SCHEDULE OF REQUIREMENTS (continued)**PALAEONTOLOGICAL RESOURCES**

Pursuant to Section 37(2) of the *Historical Resources Act*, a Historic Resources Impact Assessment for palaeontological resources is to be conducted on behalf of the proponent by a palaeontologist qualified to hold a palaeontological research permit within the Province of Alberta. A permit must be issued by Alberta Culture, Multiculturalism and Status of Women prior to the initiation of any palaeontological field investigations. Please allow ten working days for the permit application to be processed.

1. The Historic Resources Impact Assessment must address all areas of high palaeontological potential within the project area.
2. The Historic Resources Impact Assessment is to be carried out prior to the initiation of any land surface disturbance activities under snow free, unfrozen ground conditions. Should the project require survey under winter conditions, assessment procedures must be discussed in advance with the Royal Tyrrell Museum of Palaeontology.
3. Results of the Historic Resources Impact Assessment must be reported to Alberta Culture, Multiculturalism and Status of Women and subsequent *Historical Resources Act* approval must be granted before development proceeds.

ABORIGINAL TRADITIONAL USE SITES

There are no *Historical Resources Act* requirements associated with Aboriginal traditional use sites of a historic resource nature; however, the proponent must comply with [Standard Requirements under the Historical Resources Act: Reporting the Discovery of Historic Resources](#), which are applicable to all land surface disturbance activities in the Province.

HISTORIC STRUCTURES

There are no *Historical Resources Act* requirements associated with historic structures; however, the proponent must comply with [Standard Requirements under the Historical Resources Act: Reporting the Discovery of Historic Resources](#), which are applicable to all land surface disturbance activities in the Province.

PROVINCIALY DESIGNATED HISTORIC RESOURCES

There are no *Historical Resources Act* requirements associated with Provincially Designated Historic Resources; however, the proponent must comply with [Standard Requirements under the Historical Resources Act: Reporting the Discovery of Historic Resources](#), which are applicable to all land surface disturbance activities in the Province.

ADDITIONAL COMMENTS

1. To obtain contact information for consultants qualified to undertake the assessment work specified above, please consult the list of [Alberta Historic Resource Consultants](#).
2. In addition to any specific conditions detailed above, the proponent must abide by all [Standard Conditions under the Historical Resources Act](#).

SCHEDULE OF REQUIREMENTS (continued)

Lands Affected: All New Lands

Proposed Development Area:

MER	RGE	TWP	SEC	LSD List
4	25	52	12	13-16
4	25	52	24	5-6
4	25	52	14	1-2,7-10,15-16
4	25	52	11	9-10,15-16
4	25	52	23	1-2,8
4	25	52	13	1-4
4	24	52	7	13
4	24	52	18	4

Documents Attached:

Document Name	Document Type
RVB_concept_drawings pdf	Illustrative Material
Whitemud_TWD_concept_drawings reduced file size	Illustrative Material

**HISTORICAL RESOURCES IMPACT ASSESSMENT
(PALAEOLOGICAL RESOURCES)**

**RAINBOW VALLEY BRIDGES RENEWAL AND WHITEMUD
DRIVE UPGRADES**

FINAL REPORT (PERMIT #21-040)

PREPARED FOR:

City of Edmonton
12th Floor, Edmonton Tower,
10111 - 104 Avenue NW, Edmonton, AB
T5J 0J4

PREPARED BY:



Cutbank Palaeontological Consulting
11006 O'Brien Lake Crescent
Grande Prairie, Alberta
T8W 0H6

This document contains sensitive information about Historic Resources that are protected under provisions of the Alberta Historical Resources Act. This information is to be used to assist in planning the proposed project only. It is not to be disseminated, and no copies of this document are to be made without written permission of the Historic Resources Management Branch, Alberta Culture, Multiculturalism and Status of Women.

Executive Summary

This represents the final report for the Historical Resources Impact Assessment (HRIA) for palaeontological resources that was conducted by Cutbank Palaeontological Consulting under contract to the City of Edmonton. Field work associated with this project was undertaken in May 2021, in accordance with the requirements outlined in the Schedule "B" Letter issued by Alberta Culture and Tourism, dated April 22, 2021 (HRA Number 4715-21-0020-001).

Whitemud Drive is a major traffic artery within the City of Edmonton, running roughly east to west, and takes its name from Whitemud Creek, a tributary of the North Saskatchewan River, that it crosses along its route. Whitemud Drive is a divided, six lane freeway with controlled access via overpasses for the majority of its path through the city.

Plans for upgrading the freeway are in progress, primarily along the central portion of its route from near where it crosses Whitemud Creek up to where it crosses the North Saskatchewan River. This upgrading plan was flagged for palaeontological assessment due to the high potential for Late Cretaceous aged fossils in the vicinity of Whitemud Creek, as well as where the freeway comes down into the North Saskatchewan River Valley. A major dinosaur bonebed locality is located along Whitemud Creek, approximately 5 km upstream from where the bridge crosses, and further fossil remains have been noted along the length of the creek as well as the river valley.

The area was thoroughly surveyed via car and on foot for any possible exposures of bedrock within are proximate to the construction footprint. There was only a single, small instance of exposed bedrock within the area that was located, as the majority of the slopes had been highly landscaped in order to control erosion. However, the single, small exposure that was located did contain several small vertebrate fossil fragments, though these fossils were not scientifically informative. However, based on the presence of fossils even within such restricted exposures, and the apparent lack of significant soil cover, particularly along the slopes of Whitemud Creek, I would recommend a palaeontological monitoring program for the project if the final plans involve any significant ground disturbance. However, if finalised plans indicate little to no excavations that would expose further bedrock, further monitoring would not be necessary.

1. Project Location and Description

Whitemud Drive is a major traffic artery that runs roughly east to west through the City of Edmonton. Part of the roadway passes across its namesake, Whitemud Creek. There are a pair of bridges referred to as the Rainbow Valley Bridges, each of which can accommodate 3 lanes of traffic. Just to the west of the creek crossing, Whitemud Drive turns northward, and this is also the location where it joins with Terwillegar Drive, another major route that serves the southwest corner of the city. Whitemud Drive continues north, where it eventually crosses the North Saskatchewan River. It is through this area that the current project will be upgrading the roadway itself as well as the various access points that connect with it.

1.1 Geological setting

The underlying bedrock in this area largely consists of the Late Cretaceous Horseshoe Canyon Formation (Dawson et al 1994; Eberth and Bell 2014). The formation consists of interbedded sandstones, siltstones and mudstones with abundant coal seams (Dawson et al 1994). In the Edmonton region, the coal seams were of at least some economic value, and coal was mined in the Whitemud Creek valley at various locations (Eberth and Bell 2014). The Horseshoe Canyon Formation was deposited in marginal marine to fluvial and lacustrine environments, though in the Whitemud Creek area the deposits are primarily terrestrial in origin (Eberth and Bell 2014). In addition, thick layers of undifferentiated Pleistocene to Recent deposits can be found capping the older bedrock in many areas, and may also be a potential source of fossil materials, particularly along the North Saskatchewan River (Burns and Young 1994).

2. Previous Palaeontological Studies

The Rainbow Valley Bridges cross Whitemud Creek approximately 5 km downstream from the Danek Bonebed, a well studied *Edmontosaurus* bonebed located along the creek edge (Burns et al 2014, Eberth and Bell 2014). While this bonebed is likely the most well known site in the immediate area, other Late Cretaceous aged fossils are well known from throughout the broader North Saskatchewan River valley and its tributaries (e.g. Russell 1931, Tanke 1984). As well as Late Cretaceous material, there are also occasional records of Pleistocene and other more recent mammal remains from the various glacial and river terrace deposits along the river valley (e.g. Burns and Young 1994; Jass et al. 2011; Jass and Allan 2016; Jass and Barrón-Ortiz 2017). A wide variety of Quaternary megafauna is known from this region of Alberta, including proboscideans (Churcher and Wilson 1979, Jass and Barrón-Ortiz 2017), camelids (Jass and Allan 2016), muskoxen (Jass et al. 2011), bison (Wilson 1996; Wilson et al. 2008), and carnivorans (Burns and Young 1994).

3. Historical Resources Impact Assessment Results

3.1. Methodology

I surveyed the project footprint on 23 May, 2021. The area was easily accessible, and a search pattern that covered the entire area was used to try and survey the site as thoroughly as possible, with particular attention paid to the areas near the river and creek valley slopes. HRIA investigations of the project met or exceeded all requirements outlined in the “Schedule of Requirements” letter (Appendix A) and adhered to all requirements stipulated in the Historical Resources Act (2000) and the Archaeological and Palaeontological Research Permit Regulations (254/2002).

The area was easily accessible by car and on foot, and was almost entirely covered by grass and other vegetation. Prior to the visit, Google Earth and Streetview were used to try and locate any areas of potential exposures, though none could be located through this method. Once on site, the route was driven several times in order to search for any areas that could contain exposed rock. Further surveys on foot were conducted, in particular around the Rainbow Valley Bridges and where the freeway descends into the North Saskatchewan River valley.

3.2. HRIA Results

The area was almost entirely covered in vegetation, primarily grassy slopes (Figures 2 to 5). Slopes were heavily graded and landscaped, and there was essentially no exposed bedrock anywhere along the freeway. In the area where the freeway descended into the North Saskatchewan River valley, the slopes were largely covered by trees, and no exposure could be seen (Figures 2, 3, and 6). Along the portion of the freeway where it travels north/south, south of the North Saskatchewan River, the slopes were highly graded and entirely covered in vegetation. South of the project footprint, along Terwillegar Road, some construction could be observed where the grass cover had been stripped, though no obvious bedding could be observed, and the sediments appeared to be previously disturbed (Figure 7).

The area around the Rainbow Valley Bridges was of particular focus for the survey, as this area appeared the most likely to contain exposed bedrock that could be surveyed. However, in this area as well, there was virtually no exposure, with the exception of a small patch of exposed bedrock to the north east of the bridges (Figure 8). The area under the bridges was fully surveyed, and no bedrock could be directly observed within the project

footprint. There was a small amount of exposed bank within some of the trees along the south west side of the bridges, though this appeared highly weathered and may have been redeposited more recently (Figure 9). There was also a cutbank along the west side of the river, upstream of the bridges, that could be observed, however the cutbank could not be inspected as the slope was too steep to walk and the creek was fully up to the base (Figure 10). The area under the bridges did not appear to have any exposed bedrock, though there were several spots where the vegetation had been removed; these sites all contained reworked gravels and muds, likely left from the construction of the bridges (Figures 11 and 12). Where the roads lead up to the bridges, the earthworks that are present appear to be man made, so even if there were exposed earth, it would not be of any significance palaeontologically.

The single area of exposure that could be definitely determined to be bedrock, and not reworked materials, was found to the northeast of the bridges (Figure 13). The exposure was primarily a light grey siltstone with no obvious features, capped by an orange ironstone concretionary layer. There appeared to be only a relatively thin layer of soil covering the bedrock in this area, likely because it is along the valley slope. Other areas of exposure along the creek valley could be observed downstream, well outside the footprint, but the presence of these exposures in the same vicinity implies that the soil cover overall in the area is likely relatively thin. The concretionary layer in the small exposure appeared to be associated with a possible low concentration of vertebrate fossils, as a close inspection of the site turned up several fragmentary vertebrate fossils (Figure 14). Although most of the fossils were relatively non diagnostic, one did appear to be a possible fragment of an ornithischian tooth, though it was so weathered that the identification was only tentative (Figure 15).

While the area was almost entirely covered in vegetation, the presence of fossils within the single patch of exposed bedrock within the surveyed area suggests a high likelihood that further fossil remains would be encountered if there is significant ground disturbance, particularly along the slopes of Whitemud Creek.

4. Summary and Management Recommendations

No significant palaeontological remains were encountered within the footprint of the project, however the presence of fragmentary fossil remains within the extremely limited exposure in the survey area suggests a high likelihood of further remains being encountered if significant ground disturbance is to take place. If finalised plans for the project require a large amount of excavation, particularly near the Whitemud Creek valley, I would recommend further palaeontological monitoring of the project. If there will not be any significant ground disturbance, Historic Resources Clearance could be granted.

All recommendations are subject to approval by Alberta Culture, Multiculturalism and Status of Women.

5. References

- Burns, J.A., and Young, R.R. 1994. Pleistocene mammals of the Edmonton area, Alberta. Part I. The carnivores. *Canadian Journal of Earth Sciences*, 31: 393–400.
- Burns, J.A. 2010. Mammalian faunal dynamics in Late Pleistocene Alberta, Canada. *Quaternary International*, 217: 37–42.
- Burns, M.E., C. Coy, V.M. Arbour, P.J. Currie, and E.B. Koppelhus. 2014. The Danek *Edmontosaurus* Bonebed: new insights on the systematics, biogeography, and palaeoecology of Late Cretaceous dinosaur communities. *Canadian Journal of Earth Sciences*, 51: v-vii.
- Churcher, C., and Wilson, M. 1979. Quaternary mammals from the eastern Peace River district, Alberta. *Journal of Paleontology*, 53: 71–76.
- Dawson, F., Evans, C., Marsh, R., and Richardson, R. 1994. Uppermost Cretaceous and Tertiary strata of the Western Canada Sedimentary Basin. In *Geological atlas of the Western Canada Sedimentary Basin*. Edited by G. Mossop and I. Shetson. Canadian Society of Petroleum Geologists and Alberta Research Council, Calgary, Alta., Chap. 24, 18 p.
- Jass, C.N., and Allan, T.E. 2016. Camel fossils from gravel pits near Edmonton and Vauxhall, and a review of the Quaternary camelid record of Alberta. *Canadian Journal of Earth Sciences*, 53: 485–493.
- Jass, C.N., and Barrón-Ortiz, C.I. 2017. A review of Quaternary proboscideans from Alberta, Canada. *Quaternary International*, 443: 88–104.
- Jass, C.N., Burns, J.A., and Milot, P.J. 2011. Description of fossil muskoxen and relative abundance of Pleistocene megafauna in central Alberta. *Canadian Journal of Earth Sciences*, 48: 793–800.
- Prior, G. J., B. Hathaway, P.M. Glombick, D.I. Pana, C.J. Banks, D.C. Hay, C.L. Schneider, M. Grobe, R. Elgr, and J.A. Weiss. 2013. *Bedrock Geology of Alberta*. Alberta Geological Survey, Map 600.
- Russell, L.S. 1931. Fresh-water plesiosaurs. *The Canadian Field-Naturalist* 45: 135–137
- Sternberg, C.M. 1930. New records of mastodons and mammoths in Canada. *Canadian Field Naturalist*, 44: 59–65.
- Tanke, D.H. 1984. Dinosaurs of the Devon area (Alberta, Canada) with reference to a large hadrosaur femur. *Fossils Quarterly*, 3:19-30.
- Wilson, M.C. 1996. Late Quaternary vertebrates and the opening of the ice-free corridor, with special reference to the genus bison. *Quaternary International*, 32: 97–105.
- Wilson, M.C., Hills, L. V., and Shapiro, B. 2008. Late Pleistocene northward-dispersing *Bison antiquus* from the Bighill Creek Formation, Gallelli Gravel Pit, Alberta, Canada, and the fate of *Bison occidentalis*. *Canadian Journal of Earth Sciences*, 45: 827–859.

6. Figures



Figure 1. Footprint for the proposed improvements to Whitemud Drive and the Rainbow Valley Bridge.



Figure 2. View of Whitemud Drive, looking west, from Fox Drive (on the right hand side of the picture). Note relatively shallow, graded slopes and heavy vegetation cover.



Figure 3. Panoramic view Whitemud Drive, looking east, near the interchange with Fox Drive.



Figure 4. Panoramic view of Whitemud Drive, looking east. The overpass for 53 Ave can be seen on the left hand side of the image. Note heavily landscaped slopes and vegetation cover (erosion control measures) along the entirety of the freeway.



Figure 5. Panoramic view of Whitemud Drive looking east, near where the freeway begins to drop down into the North Saskatchewan River Valley. The river valley is towards the left of the image. Note heavy vegetation cover along the length of the freeway.



Figure 6. Thick tree cover along river valley slopes next to the freeway where it descends into the North Saskatchewan River valley. Photo is looking to the south.



Figure 7. Construction area along Terwillegar Road, south of the project footprint, where vegetation cover had been removed. No obvious bedding could be observed, and the sediments appeared to be reworked.



Figure 8. Panoramic view of the Whitemud Creek Valley, looking from the west (left of image) to the east (right of image) from Whitemud Drive. The single, small patch of exposed bedrock that could be surveyed is located in the centre right of the image, just above the paved walking path, along a secondary dirt trail.



Figure 9. Small area of possible, highly weathered exposure. Note bridge deck at right of image. Photograph is taken looking north.



Figure 10. Cutbank along Whitemud Creek, on the west side of the creek, south of the Rainbow Valley Bridges.



Figure 11. View from Whitemud Creek, looking northwest, of the slopes underneath the Rainbow Valley Bridges. Note the small patches of exposures in the centre of the image; these patches are all reworked deposits, likely from the original construction of the bridges.



Figure 12. View of the Rainbow Valley Bridges, looking south. Note graded, vegetation covered slopes next to the bridges and lack of exposed bedrock in the area.



Figure 13. The single, small patch of exposed bedrock found northeast of the Rainbow Valley Bridges. Note ironstone horizon near the top of the exposure. The patch was likely exposed through erosion of the footpath across it.



Figure 14. Fragmentary vertebrate fossils recovered from the small patch of exposed bedrock seen in Figure 13.



Figure 15. Possible fragment of an ornithischian tooth found at the exposure in Figure 13.

APPENDIX B - WILDLIFE PASSAGE ENGINEERING DESIGN GUIDELINES



Appendix D – User Checklists

The checklist presented in this section is designed as an additional tool to highlight the important questions that must be answered when designing a wildlife passage and to provide a place to organize the information obtained during the process. Use of this checklist is not a requirement and it may or may not be helpful to certain individuals.

The checklist follows the general flow of both the document and Decision Tree 1 and Decision Tree 2. If additional information is required for a specific question section references have been provided. If “unknown” is checked for any of the questions additional study may be required.

Transportation engineers may have difficulty answering some questions with certainty. As a result, it is strongly advised that the process of designing a wildlife passage be a joint effort between both ecologists and engineers.

1.1 PLANNING CHECKLIST

Project: Rainbow Valley Bridges

Date: June 24, 2021

Location: Whitemud Drive Crossing Whitemud Creek and Rainbow Valley Road

1. IMPORTANT CONSIDERATIONS

Will the activity have a substantial adverse effect by habitat modifications on any species sensitive species or sensitive natural areas identified in local or regional policies or regulations? Yes No Unknown

Will the activity have an adverse effect on locally or provincially significant wetlands through removal, filling, hydrological interruption, or others activities? Yes No Unknown

Will the activity interfere with the movement of any resident or migratory fish or wildlife species or previously existing wildlife corridors? Yes No Unknown

*Please note: Checking “Yes” or “Unknown” to one or more of the questions stated above, may result in the requirement for further biological studies and/or correspondence with various governing agents to determine regulatory requirements

2. IDENTIFY PROPOSED LAND USE

Check any of the land uses that will apply to both the project area and adjacent area. Assess both current and future land uses. Please refer to Section 3.2.1 for additional information

Residential	<input type="checkbox"/>	Industrial	<input type="checkbox"/>
Commercial	<input checked="" type="checkbox"/>	Institutional	<input type="checkbox"/>
Agricultural	<input type="checkbox"/>	Conserved	<input checked="" type="checkbox"/>

2. IDENTIFY ECOLOGICAL COMPONENTS OF PROJECT AREA

Indicate whether any of the following ecological components are located on the project area and will be affected by the proposed activity. Refer to Section 3.2.2 for assistance

North Saskatchewan River (NSR)	<input type="checkbox"/> Yes	<input checked="" type="checkbox"/> No
Water courses (excluding the NSR)	<input checked="" type="checkbox"/> Yes	<input type="checkbox"/> No
Natural Areas (Geowest 1993, Spencer 2006)	<input checked="" type="checkbox"/> Yes	<input type="checkbox"/> No
Wildlife corridors (refer to question 4)	<input checked="" type="checkbox"/> Yes	<input type="checkbox"/> No
Wetlands	<input type="checkbox"/> Yes	<input checked="" type="checkbox"/> No
Lakes	<input type="checkbox"/> Yes	<input checked="" type="checkbox"/> No
Woodland	<input checked="" type="checkbox"/> Yes	<input type="checkbox"/> No

3. IDENTIFY ECOLOGICAL COMPONENTS OF ADJACENT AREA

Indicate whether any of the following ecological components are located on the adjacent land will be affected by the proposed activity. Refer to Section 3.2.2 for assistance

North Saskatchewan River (NSR)	<input checked="" type="checkbox"/> Yes	<input type="checkbox"/> No
Water courses (excluding the NSR)	<input checked="" type="checkbox"/> Yes	<input type="checkbox"/> No
Natural Areas (Geowest 1993, Spencer 2006)	<input checked="" type="checkbox"/> Yes	<input type="checkbox"/> No
Wildlife corridors (refer to question 4)	<input checked="" type="checkbox"/> Yes	<input type="checkbox"/> No
Wetlands	<input type="checkbox"/> Yes	<input checked="" type="checkbox"/> No
Lakes	<input type="checkbox"/> Yes	<input checked="" type="checkbox"/> No
Woodland	<input checked="" type="checkbox"/> Yes	<input type="checkbox"/> No

4. IDENTIFY WILDLIFE CORRIDORS

If you are unsure whether a wildlife corridor is located on the project area, please review the checklist below. A corridor may be present if your project area contains one of the following:

Linear landscape features (Ridges, valleys, rivers, sharp breaks in vegetative cover)	<input checked="" type="checkbox"/> Yes	<input type="checkbox"/> No
Identified Natural Areas (within 1 km of the project)	<input checked="" type="checkbox"/> Yes	<input type="checkbox"/> No
Water bodies (wetlands, lakes, rivers, streams)	<input checked="" type="checkbox"/> Yes	<input type="checkbox"/> No
Known migratory pathways	<input type="checkbox"/> Yes	<input checked="" type="checkbox"/> No
Hedgerows, shelterbelts, windbreaks	<input checked="" type="checkbox"/> Yes	<input type="checkbox"/> No
Greenways	<input checked="" type="checkbox"/> Yes	<input type="checkbox"/> No

Please note that some corridors are more important ecologically than others and will have greater wildlife use, for example, a natural riparian corridor will likely have a greater diversity and frequency of wildlife use than a greenway. Please refer to Section 3.2.2 for additional resources that may be used to identify wildlife corridors.

5. IDENTIFY HABITAT IN THE PROJECT AREA

Please indicate the types of habitat located on the project area

Riparian	<input checked="" type="checkbox"/> Yes	<input type="checkbox"/> No	<input type="checkbox"/> Unknown
Permanent Water Body (Stream/Lake)	<input checked="" type="checkbox"/> Yes	<input type="checkbox"/> No	<input type="checkbox"/> Unknown
Wetland/Slough/Marsh	<input type="checkbox"/> Yes	<input checked="" type="checkbox"/> No	<input type="checkbox"/> Unknown
Trees or Forested Land	<input checked="" type="checkbox"/> Yes	<input type="checkbox"/> No	<input type="checkbox"/> Unknown
Grassland/Pasture Land/ Hay Field	<input checked="" type="checkbox"/> Yes	<input type="checkbox"/> No	<input type="checkbox"/> Unknown

Please note: Each habitat type identified above has a corresponding species list found in Appendix B. If "unknown" is checked future studies will be required

6. IDENTIFY POTENTIAL LOCATIONS FOR HABITAT RESTORATION

Please identify any possibilities for restoration of habitat and connectivity. This could include restoring portions of a cattle-damaged creek or re-planting trees. Refer to Section 3.2.3.

Natural areas that are impacted temporarily as a result of construction will be restored.

APPENDIX D – USER CHECKLIST

7. IDENTIFY CONFLICTS WITH CURRENT/FUTURE LAND USE

Please identify any foreseen conflicts between the land use and wildlife movement (Use Questions 1 through 5). This may mean that no action is required. Please refer to Section 3.3.1. An example of a land use conflict could be an area slated for industrial development that is located adjacent to a natural feature. In this situation, you may not want to promote wildlife movement into the industrial park.

Whitemud Creek and natural terrestrial habitats within the Whitemud Ravine provide important habitats for wildlife movement within the project area. The existing bridge structures at this location have potential to conflict with wildlife movement and the new/updated structures will change the dynamics of any existing conflicts. There are no changes in future land use that are anticipated to conflict with wildlife movement.

Is there reason to believe that providing mobility through this area will be beneficial and sustainable? Yes No

Wildlife mitigation will likely be required if yes is checked

8. IDENTIFY CONFLICTS WITH HABITAT

Wildlife-vehicle conflicts may occur if the project area involves the items listed below

Natural Area within 1 km	<input checked="" type="checkbox"/> Yes	<input type="checkbox"/> No	<input type="checkbox"/> Unknown
Upland-Wetland Habitat is Bisected	<input checked="" type="checkbox"/> Yes	<input type="checkbox"/> No	<input type="checkbox"/> Unknown
Wetland-Wetland Habitat is Bisected	<input type="checkbox"/> Yes	<input checked="" type="checkbox"/> No	<input type="checkbox"/> Unknown
North Saskatchewan River Valley and any of its Tributaries	<input checked="" type="checkbox"/> Yes	<input type="checkbox"/> No	<input type="checkbox"/> Unknown
The project has high traffic or speed	<input checked="" type="checkbox"/> Yes	<input type="checkbox"/> No	<input type="checkbox"/> Unknown
The project area contains species with status (Section 3.2.4.1)	<input type="checkbox"/> Yes	<input type="checkbox"/> No	<input checked="" type="checkbox"/> Unknown

Wildlife mitigation will likely be required if yes is checked; additional studies may be required if unknown is checked

9. IDENTIFY PHYSICAL BARRIERS

Please identify the presence of any potential barriers to wildlife movement

High traffic volume and/or speed (see Section 3.3) (i.e. arterial roads for fast moving wildlife, local roads for slow moving wildlife)	<input type="checkbox"/> Yes	<input checked="" type="checkbox"/> No
Perched culverts (see Section 3.3.4)	<input type="checkbox"/> Yes	<input checked="" type="checkbox"/> No
Insufficient water depth for aquatic passage (i.e. water is not deep enough for organism to physically pass)	<input type="checkbox"/> Yes	<input checked="" type="checkbox"/> No
Water velocity in excess of upstream and downstream velocity	<input type="checkbox"/> Yes	<input checked="" type="checkbox"/> No
Culverts without dry passage area	<input type="checkbox"/> Yes	<input checked="" type="checkbox"/> No

Undersized Culverts (not physically large enough to accommodate EDG or becomes blocked with debris like branches) Yes No

Retaining walls Yes No

Traditional jersey barriers and/or noise barriers Yes No

Other There is anticipated to be rip rap placed beneath the bridge structures.

Please note: These barriers will affect different EDGs in different ways. Some barriers may not be applicable to your project (e.g. Jersey barriers may not be a barrier if only Large Terrestrial species are present)

10. WILDLIFE AND TRANSPORTATION CONFLICTS

a) Please indicate whether a conflict will exist between the project and wildlife in the area? (Refer to Section 3.3.5)

Yes No

b) Can this conflict be avoided? (Refer to Section 3.4)

Yes No

Wildlife mitigation will be required if “no” is checked for 9 b)

11. PROPOSED SOLUTIONS

Please indicate what types of solutions will be used to mitigate for the disturbance to wildlife in the project area (before, after, and during).

Retention of existing habitat Yes No

Restoration or enhancement of existing habitat (Section 3.2.3) Yes No

Habitat protection during construction Yes No

Wildlife corridors Yes No

Wildlife Crossings Yes No
(Please proceed to Section 4.0 and Checklist 12.2)

Management Plan Yes No

Monitoring Yes No

Wildlife mitigation will likely be required if yes is checked

1.2 DESIGN CHECKLIST

Project: _____

Date: _____

Location: _____

1. ECOLOGICAL DESIGN GROUP

Please identify the Ecological Design Group(s) located in the project area (Refer to Section 4.3.1)

Large Terrestrial	<input checked="" type="checkbox"/> Yes	<input type="checkbox"/> No	<input type="checkbox"/> Unknown
Medium Terrestrial	<input checked="" type="checkbox"/> Yes	<input type="checkbox"/> No	<input type="checkbox"/> Unknown
Small Terrestrial	<input checked="" type="checkbox"/> Yes	<input type="checkbox"/> No	<input type="checkbox"/> Unknown
Amphibian	<input checked="" type="checkbox"/> Yes	<input type="checkbox"/> No	<input type="checkbox"/> Unknown
Aquatic	<input checked="" type="checkbox"/> Yes	<input type="checkbox"/> No	<input type="checkbox"/> Unknown
Aerial Mammal	<input type="checkbox"/> Yes	<input type="checkbox"/> No	<input checked="" type="checkbox"/> Unknown
Scavenger Birds	<input checked="" type="checkbox"/> Yes	<input type="checkbox"/> No	<input type="checkbox"/> Unknown
Birds of Prey	<input type="checkbox"/> Yes	<input type="checkbox"/> No	<input checked="" type="checkbox"/> Unknown
Water Birds	<input checked="" type="checkbox"/> Yes	<input type="checkbox"/> No	<input type="checkbox"/> Unknown
Ground Dwelling Birds	<input type="checkbox"/> Yes	<input type="checkbox"/> No	<input checked="" type="checkbox"/> Unknown
Other Birds	<input checked="" type="checkbox"/> Yes	<input type="checkbox"/> No	<input type="checkbox"/> Unknown
Unknown	<input checked="" type="checkbox"/> Yes	<input type="checkbox"/> No	<input type="checkbox"/> Unknown

If unknown is checked, please refer to Appendix B for additional studies. Consult an ecologist for assistance.

2. RARE AND PROTECTED SPECIES

Please identify any rare or protected species (Red and Blue Listed or COWSEWIC Listed) (please see Section 3.2.3.1 for further information on identifying species with status.)

The project area contains potential habitat for species of conservation concern including but not limited to Northern Long-Eared Bat, Little Brown Bat, Canadian Toad, Cape May Warbler, Bay-Breasted Warbler, Barred Owl, and Western Tanager. Habitat for these species is generally in the forested and riparian vegetation types within the project area.

If any rare or protected species have been identified additional studies will be required to determine specific crossing requirements. Regulatory agencies must be contacted if rare or protected species are identified.

3. WILDLIFE PREFERENCES

Please identify any specific needs that are required by the Ecological Design Group(s). (Refer to Section 4.3.2 and Appendix B)

The primary Ecological Design Groups to consider are large terrestrial, forest birds, and aquatic with potential for birds of prey. Minimize the extent of temporary and permanent habitat loss for all of the Ecological Design Groups applicable. Maintain passage in Whitemud Creek for aquatic species. Maintain passage of terrestrial wildlife beneath the bridge structures.

If any rare or protected species have been identified additional studies will be required to determine specific crossing requirements. Regulatory agencies must be contacted if rare or protected species are identified.

Please indicate which mitigation possibilities meet the ecological, transportation, and regulatory requirements for your project (refer to Section 4.4 and 4.5)

4. IDENTIFY APPROPRIATE MITIGATION

a) Please indicate which mitigation possibilities meet the ecological, transportation, and regulatory requirements for your project (refer to Section 4.4 and 4.5). This table corresponds to Table 4.4 and is designed to help determine what mitigation options meet the three requirements. If an option does not meet all three then it should not be considered. More than one mitigation option may meet all three requirements. In this case, the best option should be chosen or a combination of several should be considered.

	Requirements		
	Ecological	Transportation	Regulatory
Signage and/or Reflectors	<input type="checkbox"/>	<input type="checkbox"/>	<input type="checkbox"/>
Fencing	<input type="checkbox"/>	<input type="checkbox"/>	<input type="checkbox"/>
Altered Lighting	<input type="checkbox"/>	<input type="checkbox"/>	<input type="checkbox"/>
Altered Sight Lines	<input type="checkbox"/>	<input type="checkbox"/>	<input type="checkbox"/>
Public Education	<input type="checkbox"/>	<input type="checkbox"/>	<input type="checkbox"/>
Traffic Calmed Areas	<input type="checkbox"/>	<input type="checkbox"/>	<input type="checkbox"/>
Reduced Speed Limits	<input type="checkbox"/>	<input type="checkbox"/>	<input type="checkbox"/>
Wildlife "Crosswalk"	<input type="checkbox"/>	<input type="checkbox"/>	<input type="checkbox"/>
Diversionsary Methods	<input type="checkbox"/>	<input type="checkbox"/>	<input type="checkbox"/>
Reduce/Remove Roadkill	<input type="checkbox"/>	<input type="checkbox"/>	<input type="checkbox"/>
Vegetation Management	<input checked="" type="checkbox"/>	<input type="checkbox"/>	<input type="checkbox"/>
Noise Barriers	<input type="checkbox"/>	<input type="checkbox"/>	<input type="checkbox"/>
Curb Improvements	<input type="checkbox"/>	<input type="checkbox"/>	<input type="checkbox"/>
Closed Bottom Culvert	<input type="checkbox"/>	<input type="checkbox"/>	<input type="checkbox"/>
Amphibian Tunnel	<input type="checkbox"/>	<input type="checkbox"/>	<input type="checkbox"/>

APPENDIX D – USER CHECKLIST

Open Bottom Culvert	<input type="checkbox"/>	<input type="checkbox"/>	<input type="checkbox"/>
Box Culvert	<input type="checkbox"/>	<input type="checkbox"/>	<input type="checkbox"/>
Bridges**	<input checked="" type="checkbox"/>	<input checked="" type="checkbox"/>	<input type="checkbox"/>
Tunnel/Overpass	<input type="checkbox"/>	<input type="checkbox"/>	<input type="checkbox"/>

b) Please identify the crossing mitigation(s) that will BEST meet all the requirements

Maintain openness beneath the bridge structures and accommodate terrestrial wildlife passage beneath the bridge structures. Minimize extent of habitat loss as much as possible and restore temporarily disturbed areas with native vegetation to re-establish wildlife habitat.

5. MITIGATION SIZE

If culvert or bridge-like structures are selected, please calculate the size of mitigation required. This will vary depending on the Ecological Design Group and the size of the road. Use the openness calculation to help assess mitigation size (Refer to Section 4.3.3)

$\text{Openness} = \frac{\text{Height} \times \text{Width}}{\text{Length}}$	Openness Ratio (m)				
	Large Terrestrial	Medium Terrestrial	Small Terrestrial	Amphibian	Aquatic
	1.5	0.4	≤0.4	0.16	Encompasses entire channel width

EDG Preferred Openness

Large terrestrial - 1.5

Structure Length

Rainbow Valley Bridges are combined 48 m (including open space between bridges).

Structure Width

Pedestrian bridge is approximately 5 m wide.

Structure Height

Rainbow Valley Bridges have a cross sectional area of approximately 2050 m². Openness ratio = 2050/48 = 42.7.

Pedestrian Bridge width is approximately 200 m. Pedestrian Bridge height is approximately 13 m. Openness ratio = 13x200/5 = 520.

6. MITIGATION FREQUENCY

If the project area encompasses a large portion of the EDGs home range, several structures may be required to reduce vehicle-wildlife collisions and provide habitat connectivity. Please refer to Section 4.3.5 for assistance in determining if multiple structures are required and how close they must be placed.

Not applicable.

7. COST-BENEFIT ANALYSIS

A cost-benefit analysis may be completed to determine the relative need for a structure. Please note that a cost-benefit analysis may not adequately reflect the value of important habitat and rare species. Please refer to Section 4.3.6 for additional information

Not applicable.

1.3 REGULATORY CHECKLIST

This checklist provides a summary of common legislation that may be applicable to the project. Additional legislation may apply depending on the area. Please refer to Appendix C for additional information on regulatory requirements.

APPENDIX C - DRAFT GEOTECHNICAL INVESTIGATION REPORTS

**TERWILLEGAR DRIVE STAGE 2
RAINBOW VALLEY BRIDGE WIDENING AND
SHARED USE PATH BRIDGE
EDMONTON, ALBERTA
GEOTECHNICAL INVESTIGATION**



THURBER ENGINEERING LTD.



THURBER ENGINEERING LTD.

**TERWILLEGAR DRIVE STAGE 2
RAINBOW VALLEY BRIDGE WIDENING AND
SHARED USE PATH BRIDGE
EDMONTON, ALBERTA
GEOTECHNICAL INVESTIGATION**

Report

to

CIMA+

Mark Gallego, M.Eng., P.Eng.
Geotechnical Engineer

Date: September 20, 2021
File: 30442

Tamer Elshimi, Ph.D., P.Eng.
Associate | Geotechnical Review Engineer



TABLE OF CONTENTS

1.	INTRODUCTION.....	1
2.	PROJECT OVERVIEW	1
2.1	Project Background.....	1
2.2	Proposed Development.....	2
2.3	Scope of Work	3
3.	GEOTECHNICAL INVESTIGATION.....	3
3.1	Field Drilling Program	3
3.2	Laboratory Testing Program	5
4.	SUBSURFACE SOIL CONDITIONS.....	9
4.1	General Stratigraphy.....	9
4.2	Topsoil.....	9
4.3	Fill.....	9
4.3.1	Clay Fill	10
4.3.2	Clay Till Fill.....	10
4.3.3	Gravel and Sand Fill.....	10
4.3.4	Clay Shale and Sandstone Fill.....	11
4.4	Clay.....	11
4.5	Clay Till.....	11
4.6	Sand	12
4.7	Bedrock	12
5.	GROUNDWATER CONDITIONS	13
6.	FROST ACTION.....	14
7.	GEOTECHNICAL ASSESSMENT AND RECOMMENDATIONS	14
7.1	General.....	14
7.2	Foundation Recommendations	15
7.2.1	Axial Capacity of Bored Cast-in-Place Concrete Piles	15
7.2.2	Pile Groups and Settlements	17
7.2.2.1	Design Criteria	17
7.2.2.2	Ultimate Pile Capacity.....	18
7.2.2.3	Pile Group Settlement.....	18
7.2.3	Negative Skin Friction.....	18



7.2.4	Lateral Pile Analysis	20
7.3	Foundations Deformation Analyses.....	24
7.3.1	General	24
7.3.2	Analysis Methodology and Assumptions.....	24
7.3.3	Structural Elements and Loads.....	25
7.3.4	Material Properties	26
7.3.5	Analysis Results	27
7.3.6	Conclusions and Recommendations	28
7.4	Excavation, Backfilling and Drainage	29
7.4.1	Excavation and Backfilling.....	29
7.4.2	Surface Drainage	31
7.5	Slope Stability Assessment.....	31
7.5.1	General	31
7.5.2	Analysis Methodology and Assumptions.....	31
7.5.3	Material Properties and Groundwater Conditions	32
7.5.4	Analysis Results	33
7.5.5	Conclusions and Recommendations	34
7.6	Fill Settlement Analyses.....	34
7.6.1	General	34
7.6.2	Methodology and Assumptions.....	34
7.6.3	Soil Stratigraphy and Material Properties.....	35
7.6.4	Analysis Results	35
7.7	Geotechnical Instrumentation Program	36
7.8	Tie-Back Anchored Retaining Wall.....	37
7.8.1	General	37
7.8.2	Lateral Earth Pressure.....	39
7.8.3	Anchor Design.....	40
7.8.4	Grout Bond Resistance	40
7.8.5	Load Testing	41
7.8.6	Global Stability	41
7.8.7	Wall Footing	42
7.8.8	Wall Drainage.....	42
7.8.9	Protection Against Frost	43
7.9	Cement Type	43
7.10	Site Classification.....	44



8.	CONSTRUCTION INSPECTIONS.....	44
9.	LIMITATION AND USE OF REPORT	44

STATEMENT OF LIMITATIONS AND CONDITIONS

APPENDICES

APPENDIX A

Drawing 30442-RVB-1 – Site Plan Showing Approximate Test Hole and Proposed Instrument Locations

Drawing 30442-RVB-2 – Stratigraphic Cross Section A-A'

Drawing 30442-RVB-3 – Stratigraphic Cross Section E1-E1' and E2-E2'

Drawing 30442-RVB-4 – Stratigraphic Cross Section E3-E3' and E4-E4'

Drawing 30442-RVB-5 – Stratigraphic Cross Section W1-W1' and W2-W2'

Drawing 30442-RVB-6 – Stratigraphic Cross Section W3-W3' and W4-W4'

Shared Use Path Conceptual Design Drawings (Provided by AEAL)

APPENDIX B

Modified Unified Soils Classification

Symbols and Terms Used on Test Hole Logs

Test Hole Logs (2021)

APPENDIX C

Laboratory Test Results

APPENDIX D

Foundations Deformation Analysis Results

APPENDIX E

Slope Stability Analysis Results

APPENDIX F

Fill Settlement Analysis Results



1. INTRODUCTION

This report presents the results of a geotechnical investigation undertaken by Thurber Engineering Ltd. (Thurber) to support the design of widening the Rainbow Valley Bridges and a Shared Use Path (SUP) bridge, as part of the Terwillegar Drive Stage 2 project.

The geotechnical investigation was carried out in general accordance with our proposal to Mr. Jack Niepsuj, P.Eng., of CIMA+ dated November 25, 2020. Authorization to proceed with the work was received from Mr. Reg Ball of CIMA+ during the project initiation meeting on February 24, 2021.

This report supersedes our geotechnical report dated June 25, 2021 and provides updated results of engineering assessments for the fill settlements and slopes stability associated with the widening the Rainbow Valley Bridges and the SUP bridge based on the findings from additional test holes drilled recently by Thurber. Comments received from the City of Edmonton on our June 25, 2021 report are also addressed in this report.

It is a condition of this report that Thurber's performance of its professional services is subject to the attached Statement of Limitations and Conditions.

2. PROJECT OVERVIEW

2.1 Project Background

To support the significant growth in southwest Edmonton and the projected increase in travel demand, the City of Edmonton has adopted an integrated multi-modal transit plan that involves the upgrading of Terwillegar Drive and sections of the Whitemud Drive as part of the Terwillegar Drive Expansion project. The transit plan will be implemented in three stages as follows:

- Stage 1: involves the widening of Terwillegar Drive to four lanes in each direction. Construction of Stage 1 began in the fall of 2020.
- Stage 2: involves upgrades to the Terwillegar Drive / Whitemud Drive Interchange and other upgrades along Whitemud Drive; and
- Stage 3: involves the upgrading of the Terwillegar Drive / Anthony Henday Drive Interchange. Planning and design of Stage 3 is anticipated to be completed between 2021 and 2023.



Thurber was retained by CIMA+ to carry out a geotechnical investigation and assessment for the Stage 2 upgrades of Terwillegar Drive and Whitemud Drive, which comprises the following key components:

- Whitemud Drive / Terwillegar Drive interchange upgrades, including ramp upgrades, two new bridges over the Whitemud Drive and transit priority measures
- Whitemud Drive widening (from three to four lanes in each direction) and upgrades between Fox Drive and 122 Street (approximately 4.8 km of roadway)
- Rainbow Valley Bridges rehabilitation and widening and the addition of an SUP bridge.
- 53 Avenue / Terwillegar Drive segregated bus only lane.

A desktop review for the existing Rainbow Valley Bridges has previously been completed by Thurber as part of the concept level geotechnical assessment. The findings of the desktop study are provided in Thurber's report titled "Renewal/Widening of Rainbow Valley Bridges in Edmonton Concept Level Geotechnical Assessment", dated May 20, 2020, which should be read in conjunction with this report.

This report provides the results of a site-specific geotechnical investigation carried out for the Rainbow Valley Bridges widening and the proposed SUP bridge. Recommendations for the design and construction of the proposed bridge foundations, and the results of settlement and slope stability assessments associated with the cut and fill slopes are also provided in this report.

2.2 Proposed Development

Details of the existing bridge foundations, based on the design drawings provided by Associated Engineering Alberta Ltd. (AEAL), are summarized in Thurber's desktop study report dated May 20, 2020. It is understood that Option 2A described in AEAL's report titled "Rainbow Valley Bridges, B162 (WB) and B180 (EB) Whitemud Drive Over Whitemud Creek Rehabilitation and Widening Recommendations", dated August 2020, is the selected option for upgrading the existing Rainbow Valley bridges. This option will involve widening the eastbound and westbound structures by 6.1 m and 7.1 m, respectively, and will not include bus lanes. It is understood that two bridge options are being considered for the SUP bridge as follows:

- Option 1: Steel Haunch Girder
- Option 2: Steel Trapezoid Curved Girder.



The foundation layouts of both options are similar with two pier foundations between the east and west abutments, as shown on the conceptual design drawings provided by AEAL, included in Appendix A. The proposed SUP bridge will be constructed along the north side of the Rainbow Valley westbound bridge and will be supported on a standalone structure.

Based on the latest design grade surfaces provided by CIMA+ on June 14, 2021, we understand that there will be planned grade changes, where fill is expected to be placed on the north sideslopes of the existing east and west abutments and potential cuts to the south backslope near the existing west abutment.

2.3 Scope of Work

Thurber's scope of work for the Rainbow Valley bridges widening and SUP bridge consisted of the following tasks:

- Geotechnical field investigation
- Installation of groundwater monitoring wells
- Laboratory testing
- Engineering evaluations and the preparation of geotechnical reports.

3. GEOTECHNICAL INVESTIGATION

3.1 Field Drilling Program

Twelve test holes (TH21-03 to TH21-14) were drilled at the Rainbow Valley bridges between April 1 and 9, 2021. Two additional test holes (TH21-01 and TH21-02) were drilled near the northwest and southwest abutments on July 30 and 31, 2021. The test holes were advanced to depths ranging between about 10.1 m and 19.2 m below existing ground surface. The approximate test hole locations are shown on Drawing No. 30442-RVB-1 in Appendix A.

The test holes were laid out in the field by CIMA+ based on input from Thurber, AEAL and CIMA+ design teams. Prior to drilling, the test hole locations were cleared of underground utilities using the Alberta One Call system and a third-party locator, Hawkeye Line Locators Inc. An Initial Project Review (IPR) was also completed by AEAL prior to drilling in accordance with the City of Edmonton River Valley Bylaws.

A summary of the test hole drilling program details is provided in Table 3.1.



**TABLE 3.1
SUMMARY OF TEST HOLE DETAILS**

TEST HOLE NO.	DEPTH (m)	INSTRUMENT	BRIDGE	STRUCTURE
TH21-01	19.2	SP	Eastbound	West Abutment
TH21-02	10.1	N/A	Westbound / SUP	West Abutment
TH21-03	14.6	N/A	Eastbound	East Abutment
TH21-04	14.6	SP	Westbound / SUP	East Abutment
TH21-05	16.1	SP	Eastbound	East Abutment
TH21-06	17.8	N/A	Westbound / SUP	East Abutment
TH21-07	15.7	SP and VWP	Eastbound	Pier 3 (East)
TH21-08	14.5	N/A	Westbound / SUP	Pier 3 (East)
TH21-09	14.6	N/A	Eastbound	Pier 2 (Middle)
TH21-10	14.6	SP	Westbound / SUP	Pier 2 (Middle)
TH21-11	14.7	N/A	Eastbound	Pier 1 (West)
TH21-12	15.7	SP and VWP	Westbound / SUP	Pier 1 (West)
TH21-13	14.9	SP	Eastbound	West Abutment
TH21-14	14.7	N/A	Westbound / SUP	West Abutment

Note: VWP = vibrating wire piezometer
 SP = standpipe piezometer
 SUP = shared use path bridge

The drilling investigation was completed using track-mounted drill rigs equipped with both solid and hollow stem augers provided by All Service Drilling Inc. of Nisku, Alberta. In addition, test holes TH21-07 and TH21-12 were advanced using a track-mounted, coring rig provided by Mobile Augers and Research Ltd. of Edmonton, Alberta.

The field work was conducted under the supervision of a senior drilling inspector who logged the subsoil conditions and collected soil samples at regular intervals for laboratory characterization and testing.

Disturbed soil samples were obtained from the auger flights at regular intervals during drilling, and Standard Penetration Tests (SPTs) were conducted at 1.5 m depth increments in all of the test holes. Undisturbed (Shelby Tube) samples were also obtained at selected depths. The undrained shear strength (C_{pu} value) of cohesive soil samples was estimated using a pocket



penetrometer. Rock cores were also retrieved from test holes TH21-07 and TH21-12 and logged in the field by Thurber's drilling inspector.

Observations of groundwater seepage and soil sloughing from the test hole walls were noted during and upon completion of drilling. Slotted 25-mm-diameter PVC standpipe piezometers were installed in seven of the test holes to allow for monitoring of groundwater levels. Additionally, two vibrating wire piezometers (VWPs) were installed in test holes TH21-07 and TH21-12 to allow for porewater pressure measurements in the bedrock units. The standpipe and vibrating wire piezometer installations details are noted on the respective test hole logs in Appendix B and summarized in Table 5.1.

Upon completion of drilling, all test holes were backfilled with drill cuttings and a bentonite surface seal.

3.2 Laboratory Testing Program

Laboratory testing included visual classification and the determination of natural water content for all disturbed soil samples. In addition, the following laboratory tests were carried out on selected soil samples:

- Atterberg limits
- Grain size analyses
- Direct shear tests
- One-dimensional consolidation tests
- Cyclic confined compression triaxial tests
- Consolidated undrained triaxial testing
- Hydraulic conductivity tests
- Water-soluble sulphate content tests.

The results of the laboratory tests completed are summarized in Tables 3.2 to 3.9 below. The laboratory test results are noted on the test hole logs in Appendix B, and the detailed laboratory data sheets are included in Appendix C.



**TABLE 3.2
SUMMARY OF ATTERBERG LIMITS TEST RESULTS**

TEST HOLE NO.	SAMPLE DEPTH (m)	MODIFIED UNIFIED SOILS CLASSIFICATION	ATTERBERG LIMITS		
			LIQUID LIMIT (%)	PLASTIC LIMIT (%)	PLASTICITY INDEX (%)
CLAY FILL					
TH21-5	5.3 – 5.8	CH	60	28	32
TH21-5	8.4 – 8.8	CH	70	27	43
TH21-6	3.8 – 4.3	CH	69	27	42
TH21-6	5.3 – 5.8	CH	70	28	42
TH21-6	8.4 – 8.8	CH	60	24	36
TH21-10	3.5	CI	43	21	22
TH21-11	1.5	CH	52	21	31
CLAY TILL FILL					
TH21-6	2.3 – 2.7	CI	39	16	23
CLAY SHALE FILL					
TH21-6	13.0 – 13.4	CH	58	25	33
TH21-8	2.3 – 2.7	CH	56	22	34
TH21-12	5.0	CH	94	27	67
CLAY					
TH21-2	5.3 – 5.8	CH	60	28	32
TH21-7	3.5	CI	42	22	20
CLAY SHALE					
TH21-7	5.1 – 5.2	CH	57	26	31

**TABLE 3.3
SUMMARY OF GRAIN SIZE ANALYSIS RESULTS**

TEST HOLE NO.	SAMPLE DEPTH (m)	SOIL TYPE	SOIL FRACTION BY WEIGHT (%)			
			GRAVEL	SAND	SILT	CLAY
TH21-4	2.3 – 2.7	Sandstone	0.0	48.7	31.8	19.5
TH21-9	2.3 – 2.7	Sand and Silt	0.0	35.8	47.9	16.3
TH21-11	1.5	Clay Fill	0.4	33.0	37.8	28.8

**TABLE 3.4
SUMMARY OF DIRECT SHEAR TEST RESULTS**

TEST HOLE NO.	SAMPLE DEPTH (m)	SOIL TYPE	PEAK STRENGTH PARAMETERS		RESIDUAL STRENGTH PARAMETERS	
			FRICTION ANGLE, ϕ' (degrees)	EFFECTIVE COHESION, c' (kPa)	FRICTION ANGLE, ϕ' (degrees)	EFFECTIVE COHESION, c' (kPa)
TH21-7	5.1 – 5.2	Clay Shale	29	110	20	0

**TABLE 3.5
SUMMARY OF OEDOMETER TEST RESULTS**

TEST HOLE NO.	SAMPLE DEPTH (m)	SOIL TYPE	PRE-CONSOLIDATION PRESSURE (kPa)	COMPRESSION INDEX, C_c	RECOMPRESSION INDEX, C_r
TH21-5	5.3 – 5.8	Clay Fill	360	0.274	0.093
TH21-6	8.4 – 8.8	Clay Fill	305	0.243	0.073
TH21-8	2.3 – 2.7	Clay Till and Clay Shale Fill	430	0.180	0.053

**TABLE 3.6
SUMMARY OF CONFINED COMPRESSION TEST RESULTS**

TEST HOLE NO.	SAMPLE DEPTH (m)	SOIL TYPE	BULK UNIT WEIGHT (kN/m ³)	UNDRAINED SHEAR STRENGTH (kPa)	MODULUS OF ELASTICITY ¹ (MPa)
TH21-4	2.3 – 2.7	Sandstone	21.5	662	109 - 174
TH21-6	13.0 – 13.4	Clay Shale	19.8	258	119 - 139
TH21-12	8.4 – 8.6	Sandstone (SC)	22.4	1378	159 - 261
TH21-12	10.7 – 10.9	Clay Shale	22.1	2839	70 - 88

¹ Obtained from compressive strength test with cyclic loading.

**TABLE 3.7
SUMMARY OF CONSOLIDATED UNDRAINED TRIAXIAL TEST RESULTS**

TEST HOLE	SAMPLE DEPTH (m)	SOIL TYPE	BULK UNIT WEIGHT (kN/m ³)	EFFECTIVE CONFINING PRESSURE (kPa)	MAXIMUM DEVIATOR STRESS (kPa)	PORE PRESSURE RESPONSE, B _{bar}
TH21-5	8.4 – 8.8	Clay Fill	19.0 – 19.7	100 – 200	120 – 165	0.24 – 0.45
TH21-6	3.8 – 4.3	Clay Fill	19.4	80 - 250	114 – 177	0.30 – 0.37

**TABLE 3.8
SUMMARY OF HYDRAULIC CONDUCTIVITY TEST RESULTS**

TEST HOLE	SAMPLE DEPTH (m)	SOIL TYPE	AVERAGE HYDRAULIC GRADIENT	AVERAGE. EFFECTIVE CONFINING STRESS (kPa)	COEFFICIENT OF PERMEABILITY (m/s)
TH21-6	2.3 – 2.7	Clay Till Fill	20	14	5.1 X 10 ⁻¹¹
TH21-6	5.3 – 5.8	Clay Fill	24	16	5.1 X 10 ⁻¹¹

**TABLE 3.9
SUMMARY OF WATER-SOLUBLE SULPHATE TEST RESULTS**

TEST HOLE NO.	SAMPLE DEPTH (m)	SOIL TYPE	WATER SOLUBLE SULPHATE CONTENT PFRA Method (%)
TH21-03	1.60	Clay (Till)	0.04
TH21-05	3.58	Clay Till (Fill)	0.02
TH21-05	13.79	Clay	0.02
TH21-07	3.58	Clay	0.02
TH21-08	5.56	Sand	0.02
TH21-09	4.04	Clay Shale	0.02
TH21-11	3.58	Clay (Fill)	0.02
TH21-14	3.12	Clay Shale (Fill)	0.02



4. SUBSURFACE SOIL CONDITIONS

4.1 General Stratigraphy

Detailed soil information from the field program is provided on the individual test hole logs in Appendix B. A simplified stratigraphic cross-section along the centerline of the Rainbow Valley bridges is presented on Drawing No. 30442-RVB-2 in Appendix A.

The results of the geotechnical investigation indicated the following main stratigraphic units in general descending order; however, the order of these units may vary in individual test holes:

- Topsoil
- Fill
- Clay
- Clay Till
- Sand
- Bedrock.

Brief generalized descriptions of the soil and bedrock units encountered in the test holes are provided in the following subsections.

4.2 Topsoil

A layer of topsoil was encountered at the surface in test holes TH21-01, TH21-02, TH21-03, TH21-04, TH21-06, TH21-08, and TH21-11. The thickness of the topsoil ranged from approximately 100 to 200 mm. The topsoil was generally black, silty, and contained variable amounts of organics, clay, sand, and gravel.

4.3 Fill

Fill was encountered in all of the test holes near the surface except for TH21-01 and extended to depths ranging between 0.7 m and 14.9 m. The deep fills were encountered mainly at the east abutment location, with fills extending to depths of 13.4 m and 14.9 m in TH21-05 and TH21-06, respectively.



4.3.1 Clay Fill

Clay fill was encountered in all test holes except for TH21-01, TH21-08, TH21-13 and TH21-14. The clay fill was generally brown to grey, silty, and contained some fine sand and trace amounts of organics, gravel, oxides, and rootlets. Standard Penetration Test (SPT) 'N' values of the clay fill generally ranged from seven to 23 blows per 300 mm of penetration, indicating a firm to very stiff consistency. Natural moisture content of the clay fill ranged from 13 to 67 percent. Atterberg Limits tests conducted on five selected clay fill samples yielded plastic limits ranging from 21 to 28 percent and liquid limits ranging from 52 to 70 percent, indicating that the clay fill was high plastic.

4.3.2 Clay Till Fill

Clay till fill was present in test holes TH21-05, TH21-06, TH21-08, and TH21-10. The clay till fill was brown to dark brown, silty, sandy, and contained trace amounts of topsoil, coal, gravel, clay shale and sandstone fragments. Standard Penetration Test (SPT) 'N' values of the clay till fill ranged from 10 to 16 blows per 300 mm of penetration, indicating a stiff to very stiff consistency. Natural moisture content of the clay till fill ranged from 16 to 28 percent. An Atterberg Limits test conducted on a selected clay till fill sample yielded a plastic limit of 16 percent and the liquid limit of 39 percent, indicative of medium plasticity.

4.3.3 Gravel and Sand Fill

Gravel and Sand fill was encountered at the surface in test holes TH21-07, TH21-10, and TH21-14 and extended to depths ranging from 0.2 to 0.5 m below existing ground surface. The gravel and sand fill was brown to dark brown, silty, medium to fine grained and contained some organics.

Sand fill was encountered in test holes TH21-05, TH21-09 and TH21-10 at the ground surface or within the clay fill and extended to depths ranging from 0.3 to 5.3 m below existing ground surface. The sand fill was generally brown to grey, silty, medium to fine grained, and contained trace amounts of coal and organics. Standard Penetration Test (SPT) 'N' value of the sand fill was 11 blows per 300 mm of penetration, indicating that the sand was compact. Natural moisture content of the sand fill ranged from 14 to 31 percent.



4.3.4 Clay Shale and Sandstone Fill

Clay shale and sandstone fill was encountered in test holes TH21-04, TH21-05, TH21-06, TH21-08, TH21-12, and TH21-13. The clay shale and sandstone fill extended to depths ranging from 0.8 to 14.5 m below existing ground surface.

The clay shale fill was grey to dark grey, silty, and contained trace amounts of wood fragments. Standard Penetration Test (SPT) 'N' values of the clay shale fill ranged from 10 to 38 blows per 300 mm of penetration, indicating a stiff to hard consistency. Natural moisture content of the clay shale fill ranged from 20 to 41 percent. An Atterberg Limits test conducted on a selected clay shale fill sample yielded a plastic limit of 27 percent and a liquid limit of 94 percent, indicative of high plasticity.

A layer of mixed clay shale and clay till fill was encountered in TH21-08 at a depth of about 1.7 m and extended to a depth of about 3.2 m below ground surface. Standard Penetration Test (SPT) 'N' value of the clay shale and clay till fill was 14 blows per 300 mm of penetration, indicating a stiff consistency.

The sandstone fill was dark brown to grey, fine grained and contained some oxides and siltstone pieces and trace amounts of rootlets. Standard Penetration Test (SPT) 'N' value of the sandstone fill was 19 blows per 300 mm of penetration, indicating a compact relative density. Natural moisture content of the sandstone fill ranged from 18 to 20 percent.

4.4 Clay

Clay was encountered beneath the fill and sand layers in test holes TH21-01, TH21-02, TH21-05, TH21-07, and TH21-09. The thickness of the clay layer ranged from 1.0 to 5 m. The clay was brown to dark brown, silty, sandy, and contained trace amounts of oxides, gravel, and coal. Natural moisture contents of the clay ranged from 18 to 41 percent. Atterberg Limits tests conducted on selected clay samples yielded plastic limits ranging from 22 to 28 percent, and liquid limits ranging from 42 to 60 percent, indicating that the clay is medium to high plastic.

Standard Penetration Test (SPT) 'N' values measured in the clay ranged between 9 and 39 blows per 300 mm penetration, indicating a stiff to hard consistency.

4.5 Clay Till

Clay till was encountered beneath the clay fill and clay in test holes TH21-01 and TH21-03 at a depth ranging from 1.2 to 1.4 m below existing ground surface. The thickness of the clay till layer



ranged from 1.7 to 5.3 m. The clay till was brown, silty, and sandy and contained trace amounts of coal and sandstone fragments. Natural moisture contents of the clay till ranged from 11 to 33 percent.

Standard Penetration Test (SPT) 'N' value measured in the clay till ranged from 18 to 34 blows per 300 mm penetration, indicating a very stiff to hard consistency.

4.6 Sand

Sand was encountered beneath the fill layers in TH21-07 and TH21-08, within the clay till in TH21-01 and below the clay in TH21-02. The sand extended to depths ranging from 3.2 to 9.9 m below existing ground surface. The thickness of the sand layer ranges from 0.3 to 1.0 m. The sand was brown to dark brown, silty, and medium to fine grained. Natural moisture contents of the sand ranged from 16 to 23 percent.

Standard Penetration Test (SPT) 'N' value measured in the sand ranged from 5 to 12 blows per 300 mm penetration, indicating a loose to compact relative density.

4.7 Bedrock

Clay shale bedrock was encountered in all test holes except for TH21-05 at depths varying from 1.2 to 15 m below ground surface. The clay shale was light brown to dark grey, silty, with interlayered siltstone and sandstone lenses. Natural moisture contents of the clay shale ranged from 12 to 29 percent. An Atterberg Limits test conducted on a selected clay shale sample yielded a plastic limit was 26 percent and a liquid limit of 57 percent, indicative of high plasticity. Standard Penetration Test (SPT) 'N' values measured in the clay shale ranged from 17 to over 50 blows per 300 mm penetration, indicating very stiff to very hard consistency, in soil mechanics terminology.

Sandstone bedrock was encountered in all the test holes except for TH21-02, TH21-09 and TH21-11 at depths varying from 1.4 to 18 m below ground surface, mostly within the clay shale bedrock layer. The sandstone was light grey to dark brown, fine grained, silty, with interlayered siltstone layers. Natural moisture contents of the sandstone ranged from 11 to 21 percent. Standard Penetration Test (SPT) 'N' values measured in the sandstone was over 50 blows per 300 mm penetration, indicating a very dense relative density, in soil mechanics terminology.



5. GROUNDWATER CONDITIONS

The depths of sloughing and groundwater levels encountered in the test holes during the drilling are shown on the test hole logs in Appendix B.

Standpipe piezometers consisting of 25-mm diameter slotted PVC standpipes were installed in seven of the test holes to permit monitoring of groundwater levels. Two vibrating wire piezometers were installed in test holes TH21-07 and TH21-12 to allow for porewater pressure measurements in the clay shale and sandstone bedrock. Groundwater levels in the standpipes and vibrating wire piezometers were measured at test hole drilling completion and again on May 10, 2021. The short-term groundwater levels are summarized in Table 5.1 below.

Seepage was encountered in the open test holes at depths ranging from 3.8 to 14.5 m below ground surface (elevations 623.8 m to 633.8 m).

It should be noted that groundwater levels may vary between test hole locations, and seasonal fluctuations in the groundwater level due to precipitation and other factors are expected. Therefore, the actual groundwater conditions at the time of construction may vary from those recorded during this investigation. The groundwater levels should continue to be periodically monitored as the design progresses.

**TABLE 5.1
SUMMARY OF GROUNDWATER LEVEL IN TEST HOLES**

TEST HOLE NO.	DEPTH OF INSTRUMENT (m)	GROUNDWATER AT END OF DRILLING		GROUNDWATER ON MAY 10, 2021	
		DEPTH (m)	ELEVATION (m)	DEPTH (m)	ELEVATION (m)
TH21-01	19.2	Dry	-	11.8	647
TH21-04	3.2	Dry	-	Dry	-
TH21-05	16.0	14.2	628.3	11.8	630.8
TH21-07	5.4	Dry	-	4.4	626.8
TH21-07*	15.5	N/A	N/A	4.9	626.3
TH21-10	14.5	9.6	619.9	5.6	623.9
TH21-12	8.4	Dry	-	4.4	629.2
TH21-12*	15.5	N/A	N/A	7.4	626.1
TH21-13	14.3	Dry	-	11.3	636.7

*Vibrating Wire Piezometer

**Groundwater levels measured on August 25, 2021



6. FROST ACTION

The surficial soils encountered at this site are anticipated to have medium to high frost susceptibility. As such, frost heave could be a concern for roadways. In addition, frost uplift forces on piles will also have to be considered. The expected depth of frost penetration has been estimated for the averaged soil properties of in-situ materials encountered in the test holes for both the mean annual Air Freezing Index (AFI) of 1,440°C-days and the 50-year return period Air Freezing Index of 2,220°C-days. The estimated mean annual and 50-year return period depths of frost penetration are 1.6 m and 2.4 m, respectively.

The estimated depth of frost penetration is for a uniform soil type with no snow cover. The depth of frost penetration will be reduced if turf or snow cover is present. The 50-year return frost penetration depth is typically used for design, whereas the mean annual depth can be used for construction with some risk.

7. GEOTECHNICAL ASSESSMENT AND RECOMMENDATIONS

7.1 General

The results of the geotechnical investigation indicated that the subsurface conditions consist mainly of fill layers overlying native clay, clay till and sand, over clay shale and sandstone bedrock.

The construction of the new foundations should be carefully planned and executed to avoid loss of vertical or lateral support to the existing bridge foundations. We understand that belled cast-in-place concrete piles are the preferred option for the proposed bridge foundations. Driven steel piles are not recommended for the piers and west abutment foundations due to the presence of very hard clay shale and very dense sandstone bedrock at shallow depths.

To minimize the differential settlement between the existing bridge foundations (which have fully settled) and the proposed bridge foundations, it is not recommended to support the new substructures on spread footings.

A three-dimensional design surface for the proposed fills on the northeast and northwest abutments, as well as the proposed cut adjacent to the southwest abutment, was provided by CIMA+ on June 14, 2021.

Recommendations for the design of the Rainbow Valley bridges widening and SUP bridge foundations, and the results of the stability and settlement assessments of the proposed abutment fills and cut slopes are provided in the following sections.



7.2 Foundation Recommendations

7.2.1 Axial Capacity of Bored Cast-in-Place Concrete Piles

The bridge substructures may be founded on bored cast in place concrete end bearing piles embedded into the hard bedrock stratum. Both straight shaft and belled piles are feasible. The piles may be designed based on the following recommendations:

- Piles should be embedded at least 3 m into competent bedrock. It should be noted, however, that the elevation of the top of bedrock and the bedrock conditions at the bridge site vary over short distances (refer to test hole logs) and greater pile embedment depths may be required, based on field observation during construction, to find the piles in competent bedrock.
- Piles founded in undisturbed, hard bedrock may be designed based on the end bearing parameters provided in Table 7.1.
- Where necessary, skin friction along the bedrock may be included in the pile design. Skin friction parameters for the bedrock encountered at this site are provided in Table 7.2. Skin friction should be neglected along the upper fills, clay, and sand layers, and to the full depth/thickness of any new fill soils added to raise the site grades.
- For belled piles, shaft resistance along the sides of the bell and for a vertical height of one shaft diameter above the top of the bell should also be ignored in design to account for the effects of disturbances caused by bell construction and pile settlement on the skin friction along the bottom portion of the pile.
- A minimum pile shaft diameter of 600 mm is recommended to minimize the risk of voids forming during pouring of the concrete and to allow for proper cleaning and inspection of the bases.
- For straight shaft piles, a minimum pile spacing of 2.5 shaft diameters center-to-center is recommended.
- For belled piles, the spacing between the bells should not be closer than 0.5 m edge-to-edge to avoid potential conflicts between pile bases during construction.
- For belled piles, a minimum pile depth of three times the bell diameter should be provided. The bell diameter to shaft diameter ratio should not exceed 3:1 and the bell roof should not be sloped at more than 30° to the vertical.



- Longitudinal reinforcement should be provided throughout the full pile length. If piles are designed as tension elements, the pile reinforcement should be designed to resist the anticipated uplift stresses.
- Cobbles and boulders were not encountered in the test holes; nevertheless, there is a potential for random cobbles and boulders in the clay till which could hamper augering if encountered in the pile hole.
- Due to the presence of alluvium deposits in the creek floodplain and the high water table, groundwater seepage and sloughing of the overburden soils may occur during pile installation and therefore casing will be required and should be available during pile installation.
- The foundation piles are expected to be installed into very hard bedrock (in soil mechanics terminology). The appropriate equipment should be available to advance the pile excavations into the very hard bedrock.
- All pile excavations should be thoroughly cleaned and visually inspected by qualified geotechnical personnel prior to pouring concrete to help make sure a satisfactory base has been achieved. No sloughing or disturbed material should be allowed to remain in the pile excavations.
- Concrete should be poured immediately after drilling of the pile hole to reduce the risk of groundwater seepage and sloughing soil.

**TABLE 7.1
BORED CAST-IN-PLACE CONCRETE PILES
RECOMMENDED END BEARING RESISTANCE**

STRUCTURE	RECOMMENDED PILE BASE ELEVATION (m)	EXPECTED BEDROCK TYPE AT PILE BASE ELEVATION	ULTIMATE END BEARING RESISTANCE (kPa)	FACTORED ULS END BEARING RESISTANCE (kPa) GRF ⁽¹⁾ (ϕ) = 0.4
Rainbow Valley Bridges Widening				
West Abutment	640 m or deeper	Clay Shale	2,500 ⁽²⁾	1,000
Pier 1	622 m or deeper	Clay Shale		
Pier 2	620 m or deeper	Clay Shale		
Pier 3	620 m or deeper	Clay Shale		
East Abutment	623 m or deeper	Sandstone		

Shared Use Path Bridge				
West Abutment	640 m or deeper	Clay Shale	2,500 ⁽²⁾	1,000
Pier 1	621 m or deeper	Clay Shale		
Pier 2	620 m or deeper	Clay Shale		
East Abutment	621 m or deeper	Sandstone		

Notes: 1. GRF = Geotechnical resistance factor for Limit States Design.
2. End bearing piles installed at least 3 m into competent bedrock.

**TABLE 7.2
BORED CAST-IN-PLACE CONCRETE PILES
RECOMMENDED SHAFT RESISTANCE VALUES ALONG BEDROCK**

STRUCTURE	TOP OF BEDROCK ELEVATION (m)	ULTIMATE SHAFT RESISTANCE (kPa)	FACTORED SHAFT RESISTANCE (kPa)	
			COMPRESSION GRF ¹ (Φ) = 0.4	TENSION GRF (Φ) = 0.3
Rainbow Valley Bridges Widening				
West Abutment	646 m	120	48 ⁽²⁾	36
Pier 1	625 m			
Pier 2	623.5 m			
Pier 3	623 m			
East Abutment	627 m			
Shared Use Path Bridge				
West Abutment	646 m	120	48 ⁽²⁾	36
Pier 1	624 m			
Pier 2	623 m			
East Abutment	624 m			

Notes: 1. GRF = Geotechnical resistance factor for Limit States Design.
2. Shaft resistance along bedrock only. Shaft resistance along the upper soil layers and any existing or new fill should be ignored.

7.2.2 Pile Groups and Settlements

7.2.2.1 Design Criteria

Geotechnical design of piles has to satisfy two criteria. The pile (or pile group) has to have adequate factor of safety against geotechnical bearing failure, and the resulting settlements should be within tolerable limits for the structure support.



These two criteria are formally addressed in Limit States Design (LSD), where the Ultimate Limit State (ULS) refers to ultimate capacity of the pile against bearing failure and Serviceability Limit State (SLS) considers settlement criteria.

7.2.2.2 Ultimate Pile Capacity

For pile groups, it is customary to relate the ultimate capacity of a pile group to the ultimate capacity of a single pile through an efficiency factor, η (*Ref. Poulos and Davis. Pile Foundation Analysis and Design. John Wiley and Sons, 1980*), where:

$$\eta = \frac{\text{Ultimate capacity of group}}{\text{Sum of ultimate capacities of individual piles in the group.}}$$

For piles supported at least 3 m into competent bedrock and the expected group sizes and minimum recommended pile spacing to pile diameter ratio of 2.5, the group efficiency factor may be taken as 1.0 for estimation of ultimate group capacity; hence the factored ULS pile group capacity may also be based on a group efficiency factor of 1.0. In other words, it is not necessary to reduce the factored ULS pile capacity of a group of piles.

7.2.2.3 Pile Group Settlement

Pile group settlement is generally greater than the equivalent individual pile settlement, (i.e., assuming the same average pile loading), due to the interaction of piles within a group on each other. The results of three-dimensional settlement analyses for the proposed foundations configuration provided by AEAL are provided in Section 7.3.

7.2.3 Negative Skin Friction

Based on the conceptual design drawings from CIMA+, it is understood that up to 6 m of new fill may be placed on the north sideslopes of the east and west abutments. As such, the north piles of the east and west abutments may be subjected to downdrag forces due to the new fill settlement.

To limit the effects of negative skin friction, it is preferable to install the piles after the completion of east and west abutment fill construction. If the project schedule requires piles to be constructed first, the pile sections within the fills above site grade should be fitted with permanent smooth steel casings. The casings may be coated with a bond breaker paint. The use of compressible bond breakers should be avoided as they could potentially affect the lateral resistance of piles.



Downdrag forces increase the structural loads on the pile and could also increase the pile settlement (Serviceability Limit State). Downdrag forces, however, have no effect on the geotechnical axial capacity of the pile at Ultimate Limit State (Canadian Foundation Engineering Manual, 2006).

It is important to note that downdrag load and transient live load do not combine, and that two separate loading cases must be considered in assessing the structural capacity of the pile section: permanent load plus drag load, but no transient live load; and permanent load plus transient live load, but no drag load.

The downdrag may also increase the pile settlement and therefore should be accounted for when evaluating the Serviceability Limit State of the pile. The effect of downdrag loads on pile settlement can be estimated once the pile dimensions and loading are known, and information on the fill depths, quality, and schedule of placement have been determined. For piles founded in the competent bedrock stratum underlying the project, additional settlements induced by downdrag forces are not expected to govern the pile design.

For preliminary design purposes, negative skin friction, q_n , may be calculated using the effective stress analysis approach and the following formula:

$$q_n = \beta \times \sigma_v'$$

Where:

β = combined shaft resistance factor for downdrag (use 0.4 for compacted granular fill and 0.25 for clay fill)

σ_v' = vertical effective stress adjacent to the pile including the weight of new fill. The unit weights of fill materials are provided in Table 7.3.



TABLE 7.3
RECOMMENDED UNIT WEIGHT FOR DIFFERENT SOILS

MATERIAL	BULK UNIT WEIGHT (kN/m³)	SUBMERGED UNIT WEIGHT (kN/m³)
Granular fill	21.5	11.5
Clay Fill	18.0	8.0

To calculate drag forces, the negative skin friction (q_n) should be applied to the surface area of the pile from the cut-off elevation to the depth of the neutral plane. The depth of the neutral plane will depend on the depth and quality of fill, schedule of fill placement, pile dimensions and design loads and thickness of compressible soils in the foundations. For preliminary design purposes, the neutral plane may be assumed at the base of the new fill.

The drag loads are unfactored and an appropriate load factor should be applied. According to the Canadian Highway Bridge Design Code (CSA, 2019), a load factor of 1.25 should be applied to the negative skin friction for Ultimate Limit States design.

7.2.4 Lateral Pile Analysis

Vertical piles subject to lateral loads should be checked for lateral movement and structural capacity of pile section under lateral loading. Design of laterally loaded piles is generally governed by Serviceability Limit States (SLS) to ensure top of pile movements are within specified design criterion.

Lateral pile performance may be analyzed by structural software using the design lateral loads on the piles and using the modulus of horizontal subgrade reaction to represent the lateral soil response.

For preliminary design, the recommended values of the modulus of horizontal subgrade reaction for 1.0 m diameter single piles, k_{s1} , are presented in Table 7.4 and 7.5 for Rainbow Valley bridges and SUP bridge, respectively. The k_{s1} values for piles of different diameters can be estimated using the expression described in the subsequent paragraphs. The modulus of horizontal subgrade reaction values are considered suitable for pile deflections of up to 6 mm or one percent of the pile diameter (or width) whichever is greater.



TABLE 7.4
PRELIMINARY VALUES OF MODULUS OF
HORIZONTAL SUBGRADE REACTION FOR 1.0 M DIAMETER PILES
RAINBOW VALLEY BRIDGES

STRUCTURE	ELEVATION (m)	SOIL TYPE	ESTIMATED MODULUS OF HORIZONTAL SUBGRADE REACTION k_{s1} (MN/m ³)	ULTIMATE HORIZONTAL BEARING RESISTANCE q_{ult} (kPa)
West Abutment	Above 646	Fill / Clay Shale	0-30 ⁽¹⁾	0-900 ⁽¹⁾
	640 to 646	Clay Shale	60	1800
	640 m or deeper	Clay Shale	90	2700
Pier 1	Above 625	Fill	0-20 ⁽²⁾	0- 540 ⁽²⁾
	625 m or deeper	Clay Shale	90	2700
Pier 2	Above 623.5	Fill / Clay	0-20 ⁽³⁾	0-540 ⁽³⁾
	623.5 m or deeper	Clay Shale	90	2700
Pier 3	Above 623	Fill / Sand	0-20 ⁽⁴⁾	0-540 ⁽⁴⁾
	623 m or deeper	Clay Shale	90	2700
East Abutment	Above 631	Fill	0-30 ⁽⁵⁾	0-900 ⁽⁵⁾
	631 to 627	Clay Shale or Sandstone Fill	40	1150
	627 m or deeper	Sandstone	90	2700

Notes:

1. Lateral modulus of subgrade reaction and ultimate horizontal bearing resistance values increase linearly from zero at ground surface to elevation 646.
2. Lateral modulus of subgrade reaction and ultimate horizontal bearing resistance values increase linearly from zero at ground surface to elevation 625.
3. Lateral modulus of subgrade reaction and ultimate horizontal bearing resistance values increase linearly from zero at ground surface to elevation 623.5.
4. Lateral modulus of subgrade reaction and ultimate horizontal bearing resistance values increase linearly from zero at ground surface to elevation 623.
5. Lateral modulus of subgrade reaction and ultimate horizontal bearing resistance values increase linearly from zero at ground surface to elevation 631.



**TABLE 7.5
PRELIMINARY VALUES OF MODULUS OF
HORIZONTAL SUBGRADE REACTION FOR 1.0 M DIAMETER PILES
SHARED USE PATH BRIDGE**

STRUCTURE	ELEVATION (m)	SOIL TYPE	ESTIMATED MODULUS OF HORIZONTAL SUBGRADE REACTION k_{s1} (MN/m³)	ULTIMATE HORIZONTAL BEARING RESISTANCE q_{ult} (kPa)
West Abutment	Above 646	Fill / Clay Shale	0-30 ⁽¹⁾	0-900 ⁽¹⁾
	640 to 646	Clay Shale	60	1800
	640 m or deeper	Clay Shale	90	2700
Pier 1	Above 624	Fill	0-20 ⁽²⁾	0- 540 ⁽²⁾
	624 m or deeper	Clay Shale	90	2700
Pier 2	Above 623	Fill / Clay	0-20 ⁽³⁾	0-540 ⁽³⁾
	623 m or deeper	Clay Shale	90	2700
East Abutment	Above 631	Fill	0-30 ⁽⁴⁾	0-900 ⁽⁴⁾
	631 to 624	Clay Shale or Sandstone Fill	40	1150
	624 m or deeper	Sandstone	90	2700

Notes:

1. Lateral modulus of subgrade reaction and ultimate horizontal bearing resistance values increase linearly from zero at ground surface to elevation 646.
2. Lateral modulus of subgrade reaction and ultimate horizontal bearing resistance values increase linearly from zero at ground surface to elevation 624.
3. Lateral modulus of subgrade reaction and ultimate horizontal bearing resistance values increase linearly from zero at ground surface to elevation 623.
4. Lateral modulus of subgrade reaction and ultimate horizontal bearing resistance values increase linearly from zero at ground surface to elevation 631.

It should be noted that the modulus of horizontal subgrade reaction is not a fundamental soil property and is dependent on the pile diameter (or width). The modulus of horizontal subgrade reaction, k_{s1} , applies to a pile diameter (or width) of 1 m, and a correction should be used for piles of larger or smaller diameter using the following formula:

$$k_B = k_{s1} \times 1/B \quad (\text{MN/m}^3)$$

Where:



- k_B = modulus of horizontal subgrade reaction for a pile diameter (or width) of B (MN/m³)
- k_{s1} = modulus of horizontal subgrade reaction for a pile of 1 m diameter (or width) (MN/m³)
- B = pile diameter (or width) (m)

The spring constant, K, for a pile diameter of B and segment length of L is calculated as follows:

$$K = k_B \times B \times L \text{ (MN/m).}$$

It should be noted that the values of the modulus of horizontal subgrade reaction provided in Table 7.4 and 7.5 apply to a single pile or piles in a group where the piles are arranged in a row with a centre-to-centre spacing (S) equal to or greater than approximately four times the pile diameter or width (B). In order to account for the pile group effect in the Serviceability and Ultimate Limit States analyses, the recommended reduction factors in Table 7.6 should be applied to the design values of the modulus of horizontal subgrade reaction provided in Tables 7.4 and 7.5 for piles with S/B (ratio of centre-to-centre spacing to pile diameter) less than four.

**TABLE 7.6
GROUP REDUCTION FACTORS FOR
MODULUS OF HORIZONTAL SUBGRADE REACTION**

CENTRE-TO-CENTRE PILE SPACING TO PILE DIAMETER, S/B	REDUCTION FACTOR
2.5	0.8
3	0.9
4	1.0

Note: Reduction factors are for piles arranged in a row perpendicular to the direction of the applied lateral load.

Where the pile group lateral deflection exceeds tolerable limits, the individual pile load should be reduced by an appropriate amount to obtain acceptable lateral deflection. In such cases it may be necessary to increase the size of the pile group or the individual pile dimensions in order to support the pile group design load with acceptable lateral deflection.

A refined geotechnical analysis was undertaken by Thurber for the proposed foundations configurations and the results are provided in the following section.



7.3 Foundations Deformation Analyses

7.3.1 General

Three-dimensional deformation analyses were carried out by Thurber to estimate the long-term vertical settlements and lateral deformations of the proposed foundations based on the preliminary configuration of the bridge foundations provided by AEAL, included in Appendix A. The methodology, assumptions, and the results of the deformation analyses are presented in the following sections.

7.3.2 Analysis Methodology and Assumptions

The deformation analyses were carried out using the finite element software Plaxis 3D. This software was developed specifically for the analysis of three-dimensional geomechanics and soil-structure interaction problems using the finite element method.

Deformation analyses were carried out for the five groups of foundations, with the locations shown on the attached conceptual AEAL Drawings in Appendix A.

The geometry of the existing foundations of the bridges at each cross-section was developed using the as-built and design drawings provided to Thurber. A summary of the existing foundations has been documented in Thurber's desktop review report, dated May 20, 2020.

The geometry of the proposed foundations of the bridges at each cross-section was developed using the information provided by AEAL on June 17, 2021.

The analyses were carried out in stages to simulate the anticipated sequence of construction and operation as follows:

- The in-situ stress field of the slope was first established in the initial computation phase.
- The existing foundations were then added to the model.
- The new foundations were then added to the model after the calculated settlement of existing foundations was set to zero.
- Simulation of long-term performance of the proposed foundations was estimated by applying the SLS loads to the proposed foundations.

The finite element mesh of the computational domain is shown on various Figures in Appendix D.



7.3.3 Structural Elements and Loads

In the deformation analyses, the proposed concrete foundations were simulated using volume elements with defined interface elements. A summary of the bridge foundations configuration, as provided by AEAL on June 17, 2021, is provided in Table 7.7 and Table 7.8.

**TABLE 7.7
BRIDGE FOUNDATIONS CONFIGURATION USED IN THE 3D DEFORMATION ANALYSES
BRIDGE WIDENING LANES**

LOCATION	DESIGN SUMMARY
Pier 1	2 Piles, 3.5 m centre-to-centre spacing. Shaft Diameter = 1.0m Bell Diameter = 2.9 m Pile Cap = 5.1 x 2.8 x 1.6m
Pier 2	
Pier 3	
West Abutment (1)	2 Piles, 3 m centre-to-centre spacing. Shaft Diameter = 1.0m Bell Diameter = 2.4 m Pile Cap = 4.6 x 2.6 x 1.6m
East Abutment (2)	2 Piles, 3m centre-to-centre spacing. Shaft Diameter = 1.5m Bell Diameter = 2.4 m Pile Cap = 4.6 x 2.6 x 1.6m

**TABLE 7.8
BRIDGE FOUNDATIONS CONFIGURATION USED IN THE 3D DEFORMATION ANALYSES
SHARED USE PATH (SUP) OPTION 2**

CROSS SECTION	DESIGN SUMMARY
Pier 1	2 Piles, 3.5m centre-to-centre spacing. Shaft Diameter = 1.0 m Bell Diameter = 2.9 m Pile Cap 5.1 x 2.6 x 1.6m
Pier 2	
West Abutment (1)	2 Piles, 3.5m centre-to-centre spacing. Shaft Diameter = 1.0m Bell Diameter = 2.0 m Pile Cap 5.1 x 2.6 x 1.6m
East Abutment (2)	

The SLS loads per pile were provided by AEAL to Thurber and are summarized in Tables 7.9 and 7.10.

**TABLE 7.9
SLS LOADS PER PILE USED IN THE DEFORMATION ANALYSES
BRIDGE WIDENING LANES**

	WESTBOUND			EASTBOUND		
	AXIAL (kN)	TRANSVERSE (kN)	LONGITUDINAL (kN)	AXIAL (kN)	TRANSVERSE (kN)	LONGITUDINAL (kN)
Pier 1	5390	510	230	5120	484	218
Pier 2	5390	860	190	5120	818	180
Pier 3	5390	1200	180	5120	1140	172
West Abutment (1)	2639	396	264	2507	516	251
East Abutment (2)	2639	351	263	2507	516	251

**TABLE 7.10
SLS LOADS PER PILE USED IN THE DEFORMATION ANALYSES
SHARED USE PATH (SUP) - OPTION 2**

	AXIAL (kN)	TRANSVERSE (kN)	LONGITUDINAL (kN)
Pier 1	4600	660	390
Pier 2	4600	660	390
West Abutment (#1)	2280	185	115
East Abutment (#2)	2280	185	115

7.3.4 Material Properties

In the three-dimensional deformation analyses, the concrete foundations were simulated using volume elements with a linear elastic material model. The response of different soils was simulated using a linear elastic, perfectly plastic Mohr-Coulomb model (MC model). Soil parameters used to define the MC model were estimated based on the results of the geotechnical investigation carried out by Thurber and are summarized in Table 7.11.

**TABLE 7.11
SOIL PARAMETERS USED IN THE ANALYSES**

SOIL LAYER	MATERIAL MODEL	γ (kN/m ³)	ϕ' (°)	c' (kPa)	E (MPa)	ν
Clay Fill	MC	19	20	5	25	0.35
Clay	MC	19	20	1	15	0.35
Clay Shale and Sandstone Fill	MC	20	20	10	40	0.35
Alluvial Deposits (Clay and Silt)	MC	18	20	1	15	0.30
Clay Shale and Sandstone Bedrock	MC	21	25	20	200	0.35

γ , total unit weight; ϕ' , effective friction angle; c' , effective cohesion; E, elastic modulus; ν , Poisson's ratio

7.3.5 Analysis Results

The results of the deformation analyses are summarized in Table 7.12, 7.13 and 7.14 below. Selected plots of the deformation analysis results are also attached in Appendix D. Deformations are reported in the axial (u_z), transverse (u_x), and longitudinal directions (u_y)

**TABLE 7.12
SUMMARY OF VERTICAL DEFORMATIONS AND ESTIMATED SPRING CONSTANTS
WIDENING WEST BOUND**

LOCATION	PILE HEAD DEFORMATION AXIAL / TRANSVERSE / LONGITUDINAL (mm)		VERTICAL SPRING CONSTANT FOR SLS LOADS (MN/m), k
	NORTH PILE	SOUTH PILE	
Pier 1	8 / 3 / 1	6 / 3 / 1	720
Pier 2	9 / 5 / 1	5 / 5 / 1	720
Pier 3	12 / 9 / 2	4 / 9 / 2	720
West Abutment (1)	5 / 3 / 4	3 / 3 / 4	600
East Abutment (2)	5 / 6 / 9	3 / 6 / 9	600

**TABLE 7.13
SUMMARY OF VERTICAL DEFORMATIONS AND ESTIMATED SPRING CONSTANTS
WIDENING EAST BOUND**

LOCATION	PILE HEAD DEFORMATION Axial / Transverse / Longitudinal (mm)		VERTICAL SPRING CONSTANT FOR SLS LOADS (MN/m), k
	NORTH PILE	SOUTH PILE	
Pier 1	5 / 2 / 1	6 / 2 / 1	720
Pier 2	4 / 2 / 1	7 / 2 / 1	720
Pier 3	4 / 11 / 2	12 / 11 / 3	720
West Abutment (1)	3 / 4 / 5	5 / 4 / 5	600
East Abutment (2)	2 / 8 / 8	4 / 8 / 8	600

**TABLE 7.14
SUMMARY OF VERTICAL DEFORMATIONS AND ESTIMATED SPRING CONSTANTS
SHARED USE PATH (SUP) FOUNDATIONS**

LOCATION	PILE HEAD DEFORMATION Axial / Transverse / Longitudinal (mm)		VERTICAL SPRING CONSTANT FOR SLS LOADS (MN/m), k
	NORTH PILE	SOUTH PILE	
Pier 1	7 / 5 / 4	6 / 4 / 3	720
Pier 2	7 / 3 / 2	4 / 3 / 2	720
West Abutment (1)	10 / 7 / 4	8 / 7 / 4	460
East Abutment (2)	5 / 3 / 4	4 / 3 / 5	460

7.3.6 Conclusions and Recommendations

Following are the main conclusions drawn from the results of the deformation analyses of the proposed foundations:

- The diameter of the east abutment piles of the widening bridges should be 1.5 m to provide the required lateral support and limit the lateral deformations to the values provided in Tables 7.12 and 7.13.
- The estimated long term vertical settlements (including the elastic shortening of the pile) at the pile head for the lane widening bridges range from about 3 to 12 mm.



- The estimated equivalent spring constants for the lane widening bridges are 720 MN/m and 600 MN/m for bell diameter of 2.9 m and 2.4 m, respectively. These spring constants should be used for SLS structural analyses only.
- The estimated lateral deformations at the pile head for the lane widening bridges range from approximately 1 to 11 mm.
- The estimated long-term settlements (including the elastic shortening of the pile) at the pile head for the SUP bridge range from about 4 to 10 mm.
- The estimated equivalent spring constants for the SUP bridge are 720 MN/m and 460 MN/m for bell diameter of 2.9 m and 2.0 m, respectively. These spring constants should be used for SLS structural analyses only.
- The estimated lateral deformations at the pile head for the SUP bridge range from approximately 2 to 7 mm.

It should be noted that the deformation analyses were carried out using the preliminary configuration and SLS loads provided by AEAL. Thurber should be notified if the foundations configuration or loads are modified during the detailed design phase and the deformation analyses should be revisited.

7.4 Excavation, Backfilling and Drainage

7.4.1 Excavation and Backfilling

In preparation for the fill placement on the north side of the existing abutments, all topsoil, organic soil, and soft/disturbed soils should be removed from below the embankment fill footprint prior to construction. Care should be taken not to disturb the subgrade during stripping and subgrade preparation. Disturbed subgrade should be scarified and re-compacted to 95 percent of the Standard Proctor Maximum Dry Density (SPMDD). If necessary, a woven geotextile may be placed over the excavated subgrade to provide reinforcement for subsequent fill placement.

It should be noted that Thurber completed the geotechnical investigation, detailed design, and construction inspection of a landslide repair east of the northeast abutment in 2008. The results of the geotechnical investigation are provided in Thurber's report "Embankment Slide on Whitemud Drive near Rainbow Valley Geotechnical Investigation" dated February 11, 2008. The landslide was a shallow failure as a result of poor surface drainage conditions. The landslide repair consisted of excavating the slide material and reconstructing the slope with low to medium plastic clay fill with geogrid reinforcement. The previous landslide repair should not have a negative impact on the proposed fill on the northeast abutment. Attention should be paid not to



damage the existing geogrid layers while preparing the existing slopes for the new fill placement. It should be noted, however, that based on the design surfaces provided by CIMA+, the proposed fill at the east headslope reduces in thickness towards the east and not a significant amount of fill is expected to be placed over the landslide repair area.

The new fills should be properly keyed into the existing sideslopes using shallow benches to avoid the formation of a preferred slip surface between the existing soils and the new fill. The proposed fill on the north side of the existing bridges should consist of low to medium plastic clay till, uniformly compacted to a minimum of 95 percent of SPMDD at water contents within plus or minus two percent of Optimum Moisture Content (OMC).

It is important to limit the water content to no more than two percent above OMC to prevent generation of high pore pressures within the fill during or shortly after construction. Other types of fill materials could also be considered for use as backfill subject to review by a geotechnical engineer. The fill should be free of organics, construction rubble, ice and snow and should be placed and uniformly compacted in horizontal lifts of 150 mm maximum thickness. It is also recommended to restrict the rate of fill placement to not greater than 1 m per week to control the build-up of excess pore pressures during fill placement.

The finished side slopes of the embankment should be topsoiled and seeded as soon as possible to promote vegetation cover.

Stockpiled materials should be kept back from the top of any excavated face by a distance of at least 1.5 times the depth of the excavation. No materials should be stockpiled near the existing creek or near the top of the sideslopes of the bridge. Locations of temporary stockpiles should be approved by a geotechnical engineer prior to construction.

The fill used to construct the northeast SUP bridge headslope and northwest SUP bridge sideslope should be reinforced with five layers of biaxial geogrid as discussed in Section 7.5. Furthermore, the headslopes should be protected with concrete aprons or an equivalent product, similar to existing headslopes, to prevent distress to the abutment foundations.

As noted in Thurber's desktop study report dated May 20, 2020, the concrete aprons covering the existing bridge headslopes are in poor condition and will require maintenance or replacement during construction of the new bridges. Gaps between the aprons and the abutment walls and between successive panels of the concrete aprons were observed at various locations. The observed damage of the concrete aprons seems to have been caused by loss of ground support and some drag forces pulling the aprons apart.



It is expected that excavation will be required to construct the pile caps for the piers near the creek. If space does not permit for an open excavation, temporary shoring or possibly a water-tight shoring system (e.g., sheet piles) should be considered to facilitate pile cap construction in dry conditions.

All of the above recommendations are provided for design purposes and are not to be considered as Occupational Health and Safety (OH&S) clearances. In all cases during construction, excavations should be consistent with Alberta OH&S Regulations and Code.

7.4.2 Surface Drainage

As noted in Thurber's desktop study report dated May 20, 2020, areas of seepage were noted along the base of the east approach fills and, on the west, cut slopes south of the eastbound bridge. Proper surface drainage including ditches lined with erosion control measures should be used to drain the groundwater and surface water away from the road and bridge substructures.

Seepage was also noted near the top of the headslope of the existing bridge abutments. Proper drainage measure such as rip rap channels or concrete gutters should be used to drain the surface water away from the bridge structures and headslopes and to replace the existing riprap channels currently on the north sideslopes of the bridges.

7.5 Slope Stability Assessment

7.5.1 General

Fill with a maximum height of 3.5 m and 6 m is expected to be placed on the northeast and northwest abutments, respectively. The southwest backslope is also expected to be cut back to facilitate the widening of the Rainbow Valley bridges.

Stability assessments of the proposed fill and cut slopes are provided in the following subsections.

7.5.2 Analysis Methodology and Assumptions

Stability analyses were carried out using the GeoStudio software employing the Limit Equilibrium method. The analyses were performed for eight selected representative cross-sections (Cross Sections E1 to E4 and W1 to W4) along the headslopes and sideslopes of the east and west abutments. The geometry of the cross-sections showing the existing slopes based on 2019 LiDAR data and the proposed design slopes are shown on Drawing Nos. 30442-RVB-3 through 30442-RVB-6. Cross-sections E1 to E4 and W2 to W4 were selected as these cross-sections are anticipated to have the largest amount of fill and the steepest design



slopes. Cross-section W1 was selected as this cross-section is anticipated to have the largest cut along the toe of the existing southwest backslope.

For the headslope areas, target factors of safety (FOS) of about 1.5 and 1.3 were used for the long and short-term conditions, respectively. For the sideslopes, a target factor of safety of 1.3 was used for long and short-term conditions.

7.5.3 Material Properties and Groundwater Conditions

The material properties used in the stability models are provided in Table 7.15 below. The soil properties were based on the results of the geotechnical investigation and our experience with similar soil conditions in the Edmonton area.

**TABLE 7.15
MATERIAL PROPERTIES USED IN STABILITY ANALYSES**

MATERIAL	UNIT WEIGHT (kN/m ³)	COHESION (kPa)	FRICTION ANGLE (DEGREE)	B-BAR
Clay Fill	19	1 ⁽¹⁾ and 5 ⁽²⁾	20	0.4 ⁽²⁾
Clay Shale and Sandstone Fill	20	5 ⁽¹⁾ and 10 ⁽²⁾	22	0.4 ⁽²⁾
Existing Fill	19	5 ⁽¹⁾ and 10 ⁽²⁾	20	0.4 ⁽²⁾
Gravel and Sand Fill	21	0	35	-
New Low to Medium Plastic Clay Till Fill	19	5	28	0.2 ⁽²⁾
Sand	19	0	30	-
Clay	19	1 ⁽¹⁾ and 5 ⁽²⁾	20	0.4 ⁽²⁾
Clay Till	19	5	28	-
Clay Shale	20	10	25	0.6 ⁽²⁾
Weathered Clay Shale and Sandstone	20	5 ⁽¹⁾ and 10 ⁽²⁾	25	0.4 ⁽²⁾
Sandstone Bedrock	20	20	35	-

1. Long term analysis
2. Short-term analysis

It was assumed that the new fill will comprise of medium plastic clay till fill compacted to the standards specified in Section 7.4 with adequate moisture content control.

The groundwater levels used in the stability analyses were based on the most recent groundwater measurements provided in Section 5.



7.5.4 Analysis Results

The results of the stability analyses carried out for the eight selected cross-sections are summarized in Table 7.16. Plots of the stability analysis results (Figures E-1 through E-23) are also provided in Appendix E.

**TABLE 7.16
SUMMARY OF SLOPE STABILITY ANALYSIS RESULTS**

CROSS SECTION	ANALYSIS TYPE	SLOPE INCLINATION (H:V)	ANALYSIS TYPE	ESTIMATED FOS*	RELEVANT FIGURE
E1-E1'	Existing Slope	3.3:1	Long Term	1.52	Figure E1
	New Fill	3:1	Short Term	1.46	Figure E2
			Long Term	1.50	Figure E3
E2-E2'	Existing Slope	3.5:1	Long Term	1.98	Figure E4
	New Fill	2:1	Short Term	1.79	Figure E5
			Long Term	1.80	Figure E6
E3-E3'	Existing Slope	2.3:1	Long Term	1.48	Figure E7
	New Fill	2.3:1	Short Term	1.47	Figure E8
			Long Term	1.46	Figure E9
E4-E4'	Existing Slope	3.3:1	Long Term	1.80	Figure E10
	New Fill	2:1	Short Term	1.49	Figure E11
			Long Term	1.36	Figure E12
W1-W1'	Existing Slope	3:1	Long Term	2.31	Figure E13
	Cut Slope	3:1	Long Term	1.94	Figure E14
W2-W2'	Existing Slope	3.3:1	Long Term	2.11	Figure E15
	New Fill	3:1	Short Term	1.42	Figure E16
			Long Term	1.60	Figure E17
W3-W3'	Existing Slope	6:1	Long Term	2.84	Figure E18
	New Fill	2.5:1	Short Term	1.43	Figure E19
			Long Term	1.40	Figure E20
W4-W4'	Existing Slope	6:1	Long Term	1.83	Figure E21
	New Fill	2.5:1	Short Term	1.39	Figure E22
			Long Term	1.50	Figure E23

*FOS – Factor of Safety



7.5.5 Conclusions and Recommendations

The proposed design grades of the abutment fill and cut provided by CIMA+ on June 14, 2021 are considered feasible based on geotechnical stability assessments.

However, to maintain the same slope inclinations as per the 3D surface provided by CIMA+, the fill for the northeast SUP bridge headslope and northwest SUP bridge sideslope (the area between Sections W2-W2' and W3-W3' as shown on Drawing No. 30442-RVB-1) should be reinforced with at least five layers of biaxial geogrid such as Nilex Type 3 biaxial geogrid or equivalent product.

For the northeast SUP bridge headslope, the geogrid layers may be placed at a vertical spacing of 0.3 m with the bottom layer placed at an elevation of 638 m. The geogrid layers should extend at least 10 m towards the east from the face of the headslope. The geogrid layers should also extend to the north from the face of the existing northeast sideslope to the face of the new sideslope.

For the northwest SUP bridge sideslope, the geogrid layers may be placed at a vertical spacing of 1 m with the bottom layer placed at an elevation of 643 m. The geogrid layers should extend at least 15 m into the fill from the face of the sideslope.

Alternatively, the above-noted slopes can be flattened to an inclination of 3H:1V, or flatter, to eliminate the requirement for geogrid reinforcement.

The stability analyses should also be revisited if any of the assumptions listed in this report becomes invalid at any point during the detailed design phase.

7.6 Fill Settlement Analyses

7.6.1 General

Settlement analyses were carried out by Thurber to estimate the long-term settlements due to the placement of the proposed fill north of the existing abutments. The methodology, assumptions, and results of the settlement analyses are presented in the following sections.

7.6.2 Methodology and Assumptions

Settlement analyses were carried out using the finite element software Plaxis 2D. The settlement analyses were performed for five selected representative cross sections (Cross Sections E1-E1', E3-E3', W2-W2', W3-W3' and W4-W4') along the headslope and



sideslope of the east and west abutments. The geometry of each cross section was developed based on the 3D design surface provided by CIMA+ on June 14, 2021. A combination of field observations and the 2019 LiDAR data were used to estimate the geometry of the slope outside the limits of the 3D surface limits. Cross sections E1-E1', E3-E3', W2-W2', W3-W3', and W4-W4' were selected for the settlement analyses as they have the largest amount of fill and are considered the most critical sections.

The analyses were carried out in stages to simulate the anticipated sequence of construction. The in-situ stress field of the slope was first established in the initial computation phase. The placement of the new fill was then modeled. Finally, the long-term settlements due to the fill placement and traffic loads, if any, were calculated.

To minimize the effects of the model boundary conditions, two-dimensional geometric models with a height of 45 m to 75 m and a width of 100 m to 130 m were adopted in the analyses. The finite element meshes of the computational domains are shown on Figures F1, F4, F7, F10, and F13, included in Appendix F.

7.6.3 Soil Stratigraphy and Material Properties

The soil stratigraphy used in the analyses were based on the results of the recent geotechnical investigation carried out by Thurber for this project in April and July 2021. Soil parameters were selected based on the field and laboratory testing results from the current project, and advanced field-testing results for similar materials in Edmonton area.

The response of foundation soils to applied loads was simulated using a linear elastic, perfectly plastic Mohr-Coulomb model (MC model). The material properties used for the analyses are summarized in Table 7.11. The groundwater conditions used in the analyses were based on the measurements of the standpipe and vibrating wire piezometers installed during the geotechnical investigation.

7.6.4 Analysis Results

The results of the deformation analyses carried out for the four selected cross-sections are summarized in Table 7.17 below. Plots of the settlement analysis results are attached in Appendix F.

The results of the settlement analyses indicated that the maximum long-term settlement along the selected cross sections ranged from approximately 25 mm to 60 mm. It is anticipated that



approximately 50 percent of the total settlement will occur within the first year after the fill is placed.

**TABLE 7.17
SUMMARY OF DEFORMATION ANALYSIS RESULTS**

CROSS SECTION	MAXIMUM LONG-TERM SETTLEMENT (mm)	MAXIMUM LONG-TERM LATERAL DEFORMATIONS (mm)	RELEVANT FIGURES
E1-E1'	24	6	F2 & F3
E3-E3'	25	10	F5 & F6
W2-W2'	45	21	F8 & F9
W3-W3'	57	17	F11 & F12
W4-W4'	56	22	F14 & F15

The results of the analyses also indicated that the long-term settlement at the elevation of the existing footings supporting the west abutment is expected to be approximately 5 to 10 mm. The impact of the new fill on the existing piles supporting the east and west abutments is expected to be negligible.

The settlement estimates are considered realistic values based on the estimated soil deformation parameters and do not include a factor of safety. In considering the tolerance of buried structures in the fill and approach slabs (if any), the settlements should be factored by ± 25 percent.

7.7 Geotechnical Instrumentation Program

The dissipation rates of construction-induced excess pore water pressures are critical to the short-term stability of the new fill at the northwest abutment. As such, it is recommended that a geotechnical instrumentation program be implemented to monitor pore water pressures and the vertical and lateral displacements of foundation soils. The monitoring data will be used to confirm design assumptions and to regulate the rate of fill placement to maintain the short-term stability of the new fill during construction. The requirements for the instrumentation program should be included as part of the tender.

The following instruments are recommended at the approximate locations shown on Drawing 30442-RVB-1 in Appendix A:



- Two vibrating wire settlement sensors (RST SSVW 105 or equivalent) installed about 0.3 m below the prepared subgrade prior to placing the new fill to monitor settlement of the ground surface during and after fill construction.
- Six vibrating wire piezometers at two locations within the footprint of the new fill to monitor pore water pressures at depths ranging between 2 and 6 m below ground surface during and after construction.
- One slope inclinometer to monitor the lateral soil deformations of the existing foundation soils and the new fill.

The cables of the settlement sensors and vibrating wire piezometers should be protected and trenched to the side of the new embankment fill to a read-out station. The cables should be connected to a data logger suitable for use in geotechnical applications and in the Edmonton weather conditions. The location of the data logger should be selected to be away from busy construction areas. The instruments and data logger should be durable enough to operate for at least 2 years after the completion of fill construction. The slope inclinometer should be protected at all times during construction and extended up through the fill by qualified geotechnical personnel.

All instruments should be installed prior to construction under the supervision of Thurber.

During construction, detailed records of the lateral and vertical extents of fill placement over time should also be kept aiding in the interpretation of monitoring data.

7.8 Tie-Back Anchored Retaining Wall

7.8.1 General

It is understood that a retaining wall may be required along the east abutment headslope of the existing Rainbow Valley bridges to keep Rainbow Valley Road open during construction of the new bridge piers and abutments. No details on the geometry of the wall and the height of retained fill are available at this time; however, it is expected that the proposed retaining wall will consist of shotcrete walls with tie-back anchors for temporary support, and precast concrete or cast in place concrete walls with tie backs (typically the same tiebacks) for permanent support. This type of retaining system has been used to support vertical cut slopes in the City of Edmonton (e.g., retaining wall on the south side of Fox Drive just west of Belgravia Road).

The advantage of this retaining wall system is that it can be built in a top-down manner with relatively small equipment and can be constructed in conjunction with slope excavation to reduce



the level of back slope cut and slope disturbance. The application of shotcrete and tie backs generally involves the following typical sequence:

1. The excavation is made from the top-down in a series of benches typically about 1.5 m high depending on the soil conditions and design anchor spacing.
2. After each bench is excavated, tie-back anchors are typically drilled and installed where the excavation face is self-supporting (i.e., mainly in cohesive soils).
3. Wire mesh and shotcrete is applied to the face of the excavation. Additional reinforcing bars are typically provided around the anchors to provide reinforcement of the shotcrete and to distribute the anchor forces.
4. Vertical micropiles may also be installed along the face of the shotcrete wall (after excavation of the first bench) where necessary to provide vertical support of the shotcrete walls and resist the vertical component of the tie back anchors. (These may also provide a template for the shotcrete wall construction).
5. Once the tie back anchor grout and shotcrete has gained sufficient strength, the tie backs should be proof tested and then locked off.
6. Once the anchors have been stressed to design load, benching can be extended to the next level and Items 2, 3 and 5 repeated.
7. Geosynthetic drains may be provided behind the shotcrete as the excavation proceeds to provide continuous vertical wall drainage behind the shotcrete. Alternatively, drainage may be provided between the shotcrete and final concrete wall. Weep holes or subdrains should be provided at the base of the wall to collect and control any seepage water.

In this method, shotcrete tie back retaining walls would be used to provide the temporary retaining wall system. Permanent support could be provided using cast in place concrete retaining walls or precast concrete retaining walls constructed in front of the temporary shotcrete walls, both types using the tie back anchors for permanent support. Where tie back anchors are used for permanent support, the anchors would need to be constructed with double corrosion resistance (DCR) in order to provide long term support.

Shotcrete walls have been used for permanent wall support in several downtown parkade structures and generally prove a smooth functional wall finish. We are not aware of any permanent shotcrete walls for highway applications in the City of Edmonton and understand there may be some issues with long term durability which would need to be taken into consideration.



Cast in place concrete retaining walls (either cantilever or with anchor support) could also be considered for the permanent walls; however, these would require additional excavation clearance for construction of the cantilever walls and backfilling behind the walls and are likely to be less efficient in these tight construction conditions.

Other top-down construction methods such as tangent pile walls are not practical with the limited construction headroom under the bridges.

7.8.2 Lateral Earth Pressure

The lateral pressures, p_h , used in the design of shotcrete walls with tie-back anchors may be estimated using the expression provided below.

$$p_h = K_o [(\gamma \times h) + q] \quad (\text{kPa})$$

Where:

- K_o = coefficient of at-rest earth pressure (Table)
- γ = soil unit weight, kN/m^3 (Table)
- h = the depth below ground surface, m
- q = surcharge pressure at ground surface (if applicable), kPa.

Table 7.18 provides the recommended values of the coefficients of lateral earth pressure and the bulk unit weights for the anticipated soil types. The submerged unit weight of the soil (bulk unit weight minus unit weight of water) should be used below the groundwater level and the hydrostatic water pressure should be taken into consideration in the design. The design groundwater levels were discussed in Section 5.

**TABLE 7.18
RECOMMENDED LATERAL EARTH PRESSURE PARAMETERS FOR VERTICAL WALLS
WITH SLOPING BACKFILLS**

SOIL LAYER	BULK UNIT WEIGHT, γ (kN/m^3)	COEFFICIENT OF LATERAL EARTH PRESSURE AT REST		
		Backslope Inclination		
		2.0H:1V	2.5H:1V	3.0H:1V
Existing Clay and Clay Till Fill	19	0.96	0.88	0.82
Clay Shale and Sandstone Fill	20	0.82	0.75	0.70



The soils retained behind the proposed shotcrete wall are expected to be mostly clay and clay till fill with some silt and sand pockets.

The retaining wall should be designed based on at-rest earth pressure condition in order to limit lateral wall movements and supported structural bridge elements.

The wall height considered in the design should account for temporary site grades during construction (e.g., to allow for the construction of the pavement section). We estimate that this could be up to approximately 1 m below the final grade in front of the wall.

7.8.3 Anchor Design

For preliminary design, the fixed anchor zones should start at a minimum distance of at least 1.5 m behind the back row of the existing bridge piles in order to limit potential load transfer to the existing bridge piles. If this distance is not considered feasible, it can be evaluated further during the detailed design.

The diameter of anchor drill holes can range from 150 to 225 mm, with a 200 mm diameter being the most common. The length of bond zone should not exceed 12 m and should be established within the very stiff fill layers or the very dense sandstone bedrock. The unbonded length of the anchor should not be less than 4.5 m for strand anchors and 3.0 m for bar anchors. Anchors should be separated by at least four bond diameters.

Permanent anchor tendons should have double corrosion protection; Class I protection in accordance with the recommendations of the Post-Tensioning Institute (PTI DC35.1-14). Dywidag bar tendons or an equivalent product may be used. Typical Dywidag bar sizes range from 26 to 36 mm. Although strand tendons are feasible, the use of bar tendons is preferred as they are easier to install and are more common in Alberta.

The anchor grout should have a water to cement ratio between 0.40 to 0.45 and a minimum compressive strength of 35 MPa at 28 days.

7.8.4 Grout Bond Resistance

For preliminary design, the tie back anchors may be designed using the presumptive ultimate and factored ULS bond resistances presented in Table 7.19. The pullout resistance, P_{ar} , of individual anchors can be determined by applying the factored ULS bond resistance values to the surface area of the fixed bond length, given by " $\pi \cdot D \cdot L$ " where D is the anchor nominal diameter and L is the fixed bond length in the respective soil layers in Table .



It should be noted that the estimated factored ULS bond resistance incorporates a geotechnical resistance factor of 0.6 based on the assumption that an adequate load testing program will be conducted to verify the ultimate load carrying capacity of the anchors. It is anticipated that pressure grouting, and possibly post-grouting could be necessary to achieve the specified ultimate bond resistances.

**TABLE 7.19
RECOMMENDED GEOTECHNICAL VALUES FOR PRESSURE GROUTED ANCHORS**

MATERIAL TYPE	BOND RESISTANCE (kPa)	
	ULTIMATE RESISTANCE	FACTORED RESISTANCE ($\Phi = 0.6$)
Clay and Clay Till Fill	40	24
Clay Shale and Sandstone Fill	60	36
Sandstone Bedrock	120	72

7.8.5 Load Testing

The ultimate bond resistance and the creep behavior of ground anchors should be verified by performing pre-production load tests on sacrificial anchors. The test anchors should be installed in the same soil unit(s) and using the same methods and equipment as the production anchors. The configuration of the test anchors and test loads should be such that the ultimate bond resistance of the grout-soil interface can be mobilized. This may require oversizing the anchor bar of the pre-production anchors to accommodate the ultimate pullout capacity. Depending on the results of the load test, anchor lengths and/or layouts may need to be adjusted. In addition, performance tests should also be conducted on a minimum of 10 percent of the production anchors. Proof tests should be performed on all other production anchors. The anchor load tests, and acceptance criteria should be in accordance with the recommendations of PTI DC35.1-14. None of the anchor load tests should be performed until the grout strength has reached at least 80 percent of the specified 28-day compressive strength.

7.8.6 Global Stability

The global stability of the retaining wall should be checked once the anchor layout design has progressed further in order to confirm that an adequate global factor of safety has been achieved.



7.8.7 Wall Footing

A spread footing may be provided at the base of the permanent concrete retaining wall to support the applied vertical loading.

It is recommended that the wall be founded at a minimum depth of 1 m below the final ground surface in front of the wall. The footing should be founded on undisturbed very stiff clay and clay till and may be designed using ultimate and factored ULS bearing resistance of 250 kPa and 125 kPa respectively, based on a resistance factor of 0.5.

In addition, the wall should be checked against sliding and overturning. An ultimate base friction factor of 0.4 may be used between soil and mass concrete. A resistance factor of 0.8 should be applied to the ultimate friction factor for Limit States Design.

7.8.8 Wall Drainage

Adequate wall drainage is essential to prevent the build up of water pressure behind the wall and to minimize frost effects. To facilitate wall drainage, it is recommended that geocomposite strip drains, at least 1.0 m in width, be installed directly against soils exposed at the excavation face. The drains should have sufficient capacity to remove any water that may collect/infiltrate behind the wall and should be continuous from top to bottom. Where it is necessary to splice drainage strips, a minimum overlap of 400 mm should be maintained.

The strip drains should be hydraulically connected to a perforated subdrain at the base of the wall to direct the collected water away from the wall area. The subdrain should comprise a 150 mm diameter perforated pipe surrounded on all sides by washed rock (minimum 300 mm thick with no more than five percent silt and clay fraction) encased in non-woven geotextile. The subdrain should be hydraulically connected to relief points or existing stormwater drains to facilitate the removal of collected water. The drainage system should be installed in accordance with the manufacturer's recommendations.

Surface water should not be allowed to pond at the top of wall. To facilitate drainage of surface water, it is recommended that a drainage swale be provided behind the wall along the toe of the backslope. The swale should collect surface water and direct it to a positive discharge point away from the wall.

Under the bridge headslopes it is expected that concrete apron slabs will prevent surface water inflow into the backfill.



7.8.9 Protection Against Frost

Freezing of soils retained behind the shotcrete walls can significantly increase the loads resisted by the shotcrete and anchors. To minimize the risk of soil freezing, it is recommended that extruded polystyrene rigid insulation be installed between the shotcrete and the final wall facing. Styrofoam Highload 40 product (or approved equal) is recommended with a minimum insulation thickness of 150 mm. To minimize frost penetration at the wall top, the insulation should also be placed below the backslope above the top of wall and should extend up slope a minimum distance of 2.4 m from the back of piles. The insulation should be installed in accordance with the manufacturer’s recommendations.

Concrete used in wall construction will be exposed to freezing and should therefore be adequately air entrained for improved durability.

7.9 Cement Type

A total of eight tests were conducted to determine the water-soluble sulphate ion (SO₄) content of soil samples recovered from the test holes. The test results are noted on the test hole logs and are summarized in Table 7.20. The “degree of exposure” of subsurface concrete to sulphate attack is also noted, based on the categories recommended by the Canadian Standards Association (CSA, 2019).

**TABLE 7.20
WATER SOLUBLE SULPHATE ION CONTENT**

TEST HOLE	DEPTH BELOW GROUND SURFACE (m)	SOIL TYPE	WATER SOLUBLE SULPHATE CONTENT PFRA Method (%)	POTENTIAL FOR SULPHATE ATTACK ON SUBSURFACE CONCRETE ¹
TH21-03	1.60	Clay (Till)	0.04	Negligible
TH21-05	3.58	Clay Till (Fill)	0.02	Negligible
TH21-05	13.79	Clay	0.02	Negligible
TH21-07	3.58	Clay	0.02	Negligible
TH21-08	5.56	Sand	0.02	Negligible
TH21-09	4.04	Clay Shale	0.02	Negligible
TH21-11	3.58	Clay (Fill)	0.02	Negligible
TH21-14	3.12	Clay Shale (Fill)	0.02	Negligible

¹ Based on the Canadian Standards Association (CSA A23.1-19)



These tests showed the presence of 0.02 to 0.04 percent water-soluble sulphate ion content in the soil samples, indicating that there is no potential for sulphate attack on the subsurface concrete. As a result, CSA Type GU (General Use hydraulic cement) may be used in the subsurface concrete at this project site.

The recommendations stated above for the subsurface concrete at this site may require further additions and/or modifications due to structural, durability, service life or other considerations that are beyond the geotechnical scope.

In addition, if imported material is required to be used at the site and will be in contact with concrete, it is recommended that the fill soil be tested for sulphate content to determine whether the above-stated recommendations remain valid.

7.10 Site Classification

Based on the results of the geotechnical investigation, the project site may be classified as Site Class C in accordance with the site classification per Table 4.1.8.4A of the National Building Code (NBCC 2019).

8. CONSTRUCTION INSPECTIONS

The performance of the various site structures will depend upon the quality of workmanship during construction. This is particularly important in regard to foundation installations and other earthwork where variations in soil conditions could occur. Therefore, it is recommended that inspection be provided by qualified geotechnical personnel during foundation installation and embankment fill construction to confirm that the piles and embankment fill are installed in competent bearing material and that the stratigraphy is similar to those that have been assumed for the design.

9. LIMITATION AND USE OF REPORT

There is a possibility that this report may form part of the design and construction documents for information purposes. This report was issued before the final design or construction details have been prepared or issued. Therefore, differences may exist between the report recommendations and the final design, contract documents, or conditions encountered during construction. In such instances, Thurber Engineering Ltd. should be contacted immediately to address these differences.

Designers and contractors undertaking or bidding the work should examine the factual results of the investigation, satisfy themselves on to the adequacy of the information for design and construction, and make their own interpretation of the data as it may affect their proposed scope of work, cost, schedule, safety, and equipment capabilities.



STATEMENT OF LIMITATIONS AND CONDITIONS

1. STANDARD OF CARE

This Report has been prepared in accordance with generally accepted engineering or environmental consulting practices in the applicable jurisdiction. No other warranty, expressed or implied, is intended or made.

2. COMPLETE REPORT

All documents, records, data and files, whether electronic or otherwise, generated as part of this assignment are a part of the Report, which is of a summary nature and is not intended to stand alone without reference to the instructions given to Thurber by the Client, communications between Thurber and the Client, and any other reports, proposals or documents prepared by Thurber for the Client relative to the specific site described herein, all of which together constitute the Report.

IN ORDER TO PROPERLY UNDERSTAND THE SUGGESTIONS, RECOMMENDATIONS AND OPINIONS EXPRESSED HEREIN, REFERENCE MUST BE MADE TO THE WHOLE OF THE REPORT. THURBER IS NOT RESPONSIBLE FOR USE BY ANY PARTY OF PORTIONS OF THE REPORT WITHOUT REFERENCE TO THE WHOLE REPORT.

3. BASIS OF REPORT

The Report has been prepared for the specific site, development, design objectives and purposes that were described to Thurber by the Client. The applicability and reliability of any of the findings, recommendations, suggestions, or opinions expressed in the Report, subject to the limitations provided herein, are only valid to the extent that the Report expressly addresses proposed development, design objectives and purposes, and then only to the extent that there has been no material alteration to or variation from any of the said descriptions provided to Thurber, unless Thurber is specifically requested by the Client to review and revise the Report in light of such alteration or variation.

4. USE OF THE REPORT

The information and opinions expressed in the Report, or any document forming part of the Report, are for the sole benefit of the Client. NO OTHER PARTY MAY USE OR RELY UPON THE REPORT OR ANY PORTION THEREOF WITHOUT THURBER'S WRITTEN CONSENT AND SUCH USE SHALL BE ON SUCH TERMS AND CONDITIONS AS THURBER MAY EXPRESSLY APPROVE. Ownership in and copyright for the contents of the Report belong to Thurber. Any use which a third party makes of the Report, is the sole responsibility of such third party. Thurber accepts no responsibility whatsoever for damages suffered by any third party resulting from use of the Report without Thurber's express written permission.

5. INTERPRETATION OF THE REPORT

- a) Nature and Exactness of Soil and Contaminant Description: Classification and identification of soils, rocks, geological units, contaminant materials and quantities have been based on investigations performed in accordance with the standards set out in Paragraph 1. Classification and identification of these factors are judgmental in nature. Comprehensive sampling and testing programs implemented with the appropriate equipment by experienced personnel may fail to locate some conditions. All investigations utilizing the standards of Paragraph 1 will involve an inherent risk that some conditions will not be detected and all documents or records summarizing such investigations will be based on assumptions of what exists between the actual points sampled. Actual conditions may vary significantly between the points investigated and the Client and all other persons making use of such documents or records with our express written consent should be aware of this risk and the Report is delivered subject to the express condition that such risk is accepted by the Client and such other persons. Some conditions are subject to change over time and those making use of the Report should be aware of this possibility and understand that the Report only presents the conditions at the sampled points at the time of sampling. If special concerns exist, or the Client has special considerations or requirements, the Client should disclose them so that additional or special investigations may be undertaken which would not otherwise be within the scope of investigations made for the purposes of the Report.
- b) Reliance on Provided Information: The evaluation and conclusions contained in the Report have been prepared on the basis of conditions in evidence at the time of site inspections and on the basis of information provided to Thurber. Thurber has relied in good faith upon representations, information and instructions provided by the Client and others concerning the site. Accordingly, Thurber does not accept responsibility for any deficiency, misstatement or inaccuracy contained in the Report as a result of misstatements, omissions, misrepresentations, or fraudulent acts of the Client or other persons providing information relied on by Thurber. Thurber is entitled to rely on such representations, information and instructions and is not required to carry out investigations to determine the truth or accuracy of such representations, information and instructions.
- c) Design Services: The Report may form part of design and construction documents for information purposes even though it may have been issued prior to final design being completed. Thurber should be retained to review final design, project plans and related documents prior to construction to confirm that they are consistent with the intent of the Report. Any differences that may exist between the Report's recommendations and the final design detailed in the contract documents should be reported to Thurber immediately so that Thurber can address potential conflicts.
- d) Construction Services: During construction Thurber should be retained to provide field reviews. Field reviews consist of performing sufficient and timely observations of encountered conditions in order to confirm and document that the site conditions do not materially differ from those interpreted conditions considered in the preparation of the report. Adequate field reviews are necessary for Thurber to provide letters of assurance, in accordance with the requirements of many regulatory authorities.

6. RELEASE OF POLLUTANTS OR HAZARDOUS SUBSTANCES

Geotechnical engineering and environmental consulting projects often have the potential to encounter pollutants or hazardous substances and the potential to cause the escape, release or dispersal of those substances. Thurber shall have no liability to the Client under any circumstances, for the escape, release or dispersal of pollutants or hazardous substances, unless such pollutants or hazardous substances have been specifically and accurately identified to Thurber by the Client prior to the commencement of Thurber's professional services.

7. INDEPENDENT JUDGEMENTS OF CLIENT

The information, interpretations and conclusions in the Report are based on Thurber's interpretation of conditions revealed through limited investigation conducted within a defined scope of services. Thurber does not accept responsibility for independent conclusions, interpretations, interpolations and/or decisions of the Client, or others who may come into possession of the Report, or any part thereof, which may be based on information contained in the Report. This restriction of liability includes but is not limited to decisions made to develop, purchase or sell land.



APPENDIX A

Drawing 30442-RVB-1 – Site Plan Showing Approximate Test Hole and Proposed Instrument Locations

Drawing 30442-RVB-2 – Stratigraphic Cross Section A-A'

Drawing 30442-RVB-3 – Stratigraphic Cross Section E1-E1' and E2-E2'

Drawing 30442-RVB-4 – Stratigraphic Cross Section E3-E3' and E4-E4'

Drawing 30442-RVB-5 – Stratigraphic Cross Section W1-W1' and W2-W2'



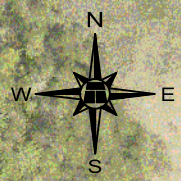
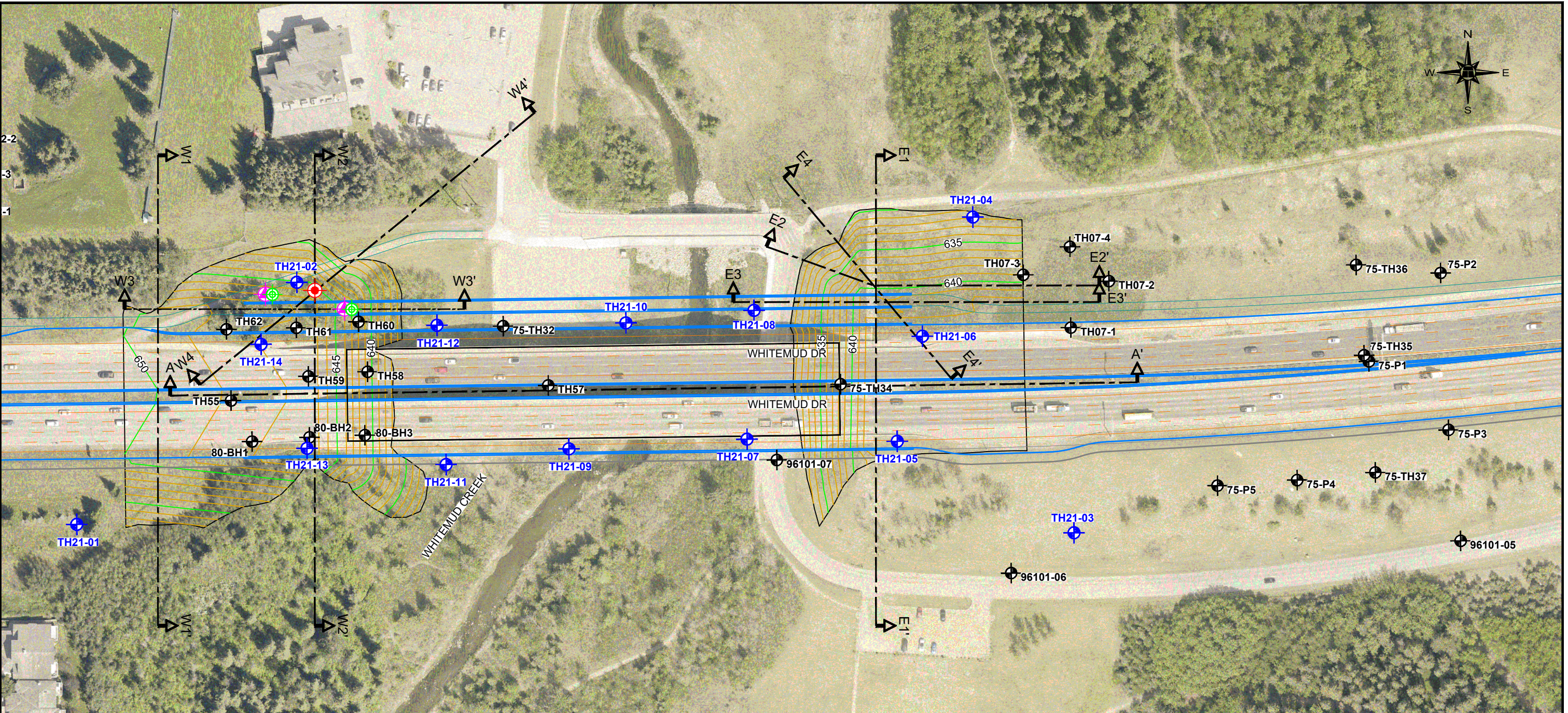

Drawing 30442-RVB-6 – Stratigraphic Cross Section W3-W3' and W4-W4'

Shared Use Path Conceptual Design Drawings (Provided by AEAL)

H:\30000\30442 Terwillegar Drive Stage 2 - Preliminary Design and Delivery\Drafting\30442-RVB-1 SEPTEMBER 20, 2021.dwg - 1N - Sep. 20, 2021



LEGEND

-  APPROXIMATE TEST HOLE LOCATION (2021)
-  APPROXIMATE TEST HOLE LOCATION (PREVIOUS)
-  SLOPE INCLINOMETER LOCATION
-  VIBRATING WIRE SETTLEMENT SENSOR
-  VIBRATING WIRE PIEZOMETERS AT DEPTHS OF 2m, 4m AND 6m

BASE PLAN PROVIDED BY CIMA+



**TERWILLEGAR DRIVE UPGRADING STAGE 2
RAINBOW VALLEY BRIDGES WIDENING AND
SHARED USE PATH BRIDGE
SITE PLAN SHOWING APPROXIMATE TEST HOLE
AND PROPOSED INSTRUMENT LOCATIONS**

DWG No. 30442-RVB-1

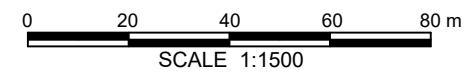

DRAWN BY	ML
DESIGNED BY	MG
APPROVED BY	TME
SCALE	1:1500
DATE	SEPTEMBER 2021
FILE No.	30442



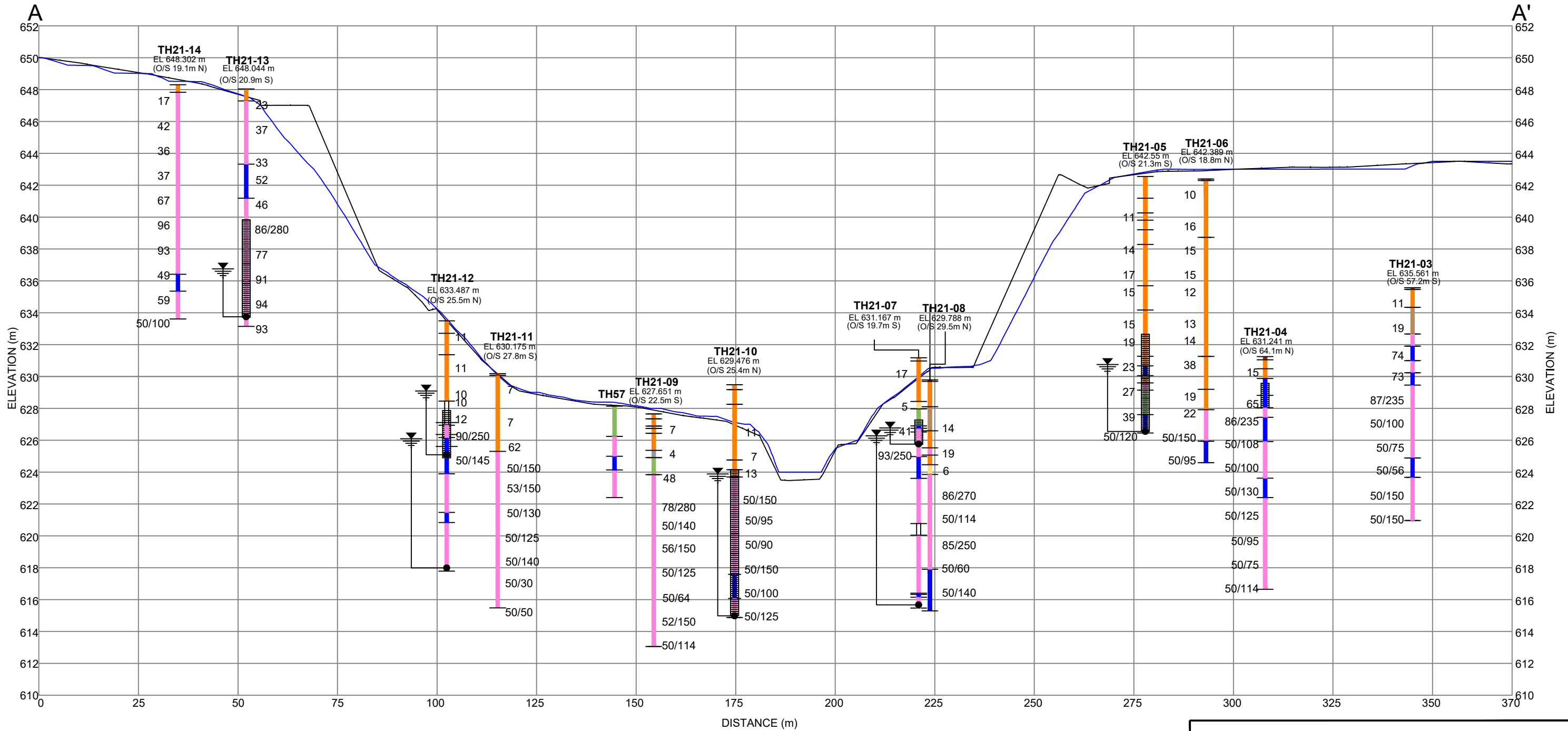

LEGEND

- SPT N VALUE
- WATER LEVEL IN PIEZOMETER (MAY 10, 2021)
- VIBRATING WIRE PIEZOMETER TIP
- STANDPIPE PIEZOMETER SCREENED INTERVAL
- GROUND SURFACE PROFILE SURVEYED ON OCTOBER 1, 2020
- GROUND SURFACE PROFILE FROM 2019 LIDAR

- TOPSOIL
- FILL
- CLAY
- CLAY TILL
- SAND, GRAVEL
- SILT
- NO RECOVERY
- CLAY SHALE
- SANDSTONE

NOTE

DATA CONCERNING THE VARIOUS STRATA HAVE BEEN OBTAINED AT THE TEST HOLE LOCATIONS ONLY. THE SOIL STRATIGRAPHY BETWEEN TEST HOLES HAS BEEN INFERRED FROM GEOLOGICAL EVIDENCE AND SO MAY VARY FROM THAT SHOWN.



**TERWILLEGAR DRIVE UPGRADING STAGE 2
RAINBOW VALLEY BRIDGES WIDENING AND
SHARED USE PATH BRIDGE**

STRATIGRAPHIC CROSS - SECTION A - A'

DWG No. 30442-RVB-2

DRAWN BY	ML
DESIGNED BY	MG
APPROVED BY	TME
SCALE	H 1:1000 V 1:250
DATE	JUNE 2021
FILE No.	30442



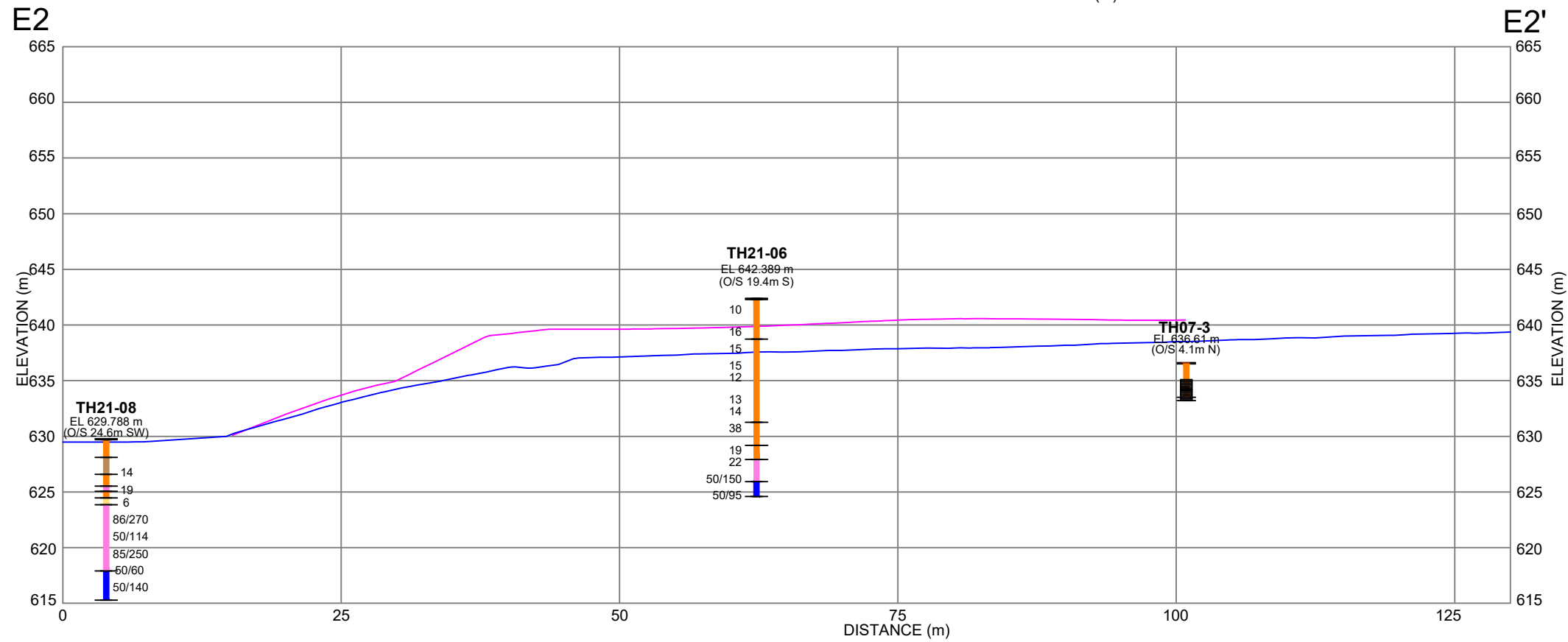
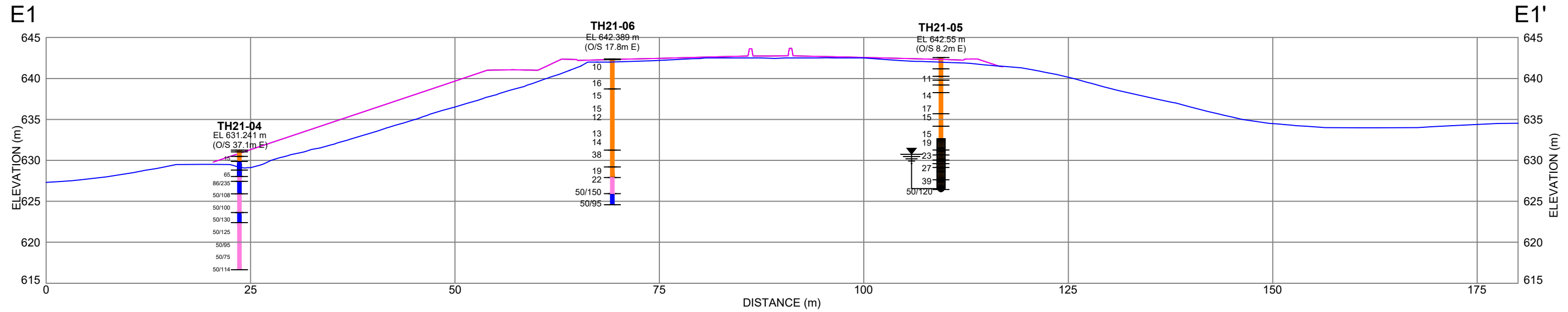

LEGEND

- SPT N VALUE
- WATER LEVEL IN PIEZOMETER (MAY 10, 2021)
- VIBRATING WIRE PIEZOMETER TIP
- STANDPIPE PIEZOMETER SCREENED INTERVAL
- DESIGN GRADE (PROVIDED BY CIMA+, JUNE 14, 2021)
- GROUND SURFACE PROFILE FROM 2019 LIDAR

- TOPSOIL
- FILL
- CLAY
- CLAY TILL
- SAND, GRAVEL
- SILT
- NO RECOVERY
- CLAY SHALE
- SANDSTONE

NOTE

DATA CONCERNING THE VARIOUS STRATA HAVE BEEN OBTAINED AT THE TEST HOLE LOCATIONS ONLY. THE SOIL STRATIGRAPHY BETWEEN TEST HOLES HAS BEEN INFERRED FROM GEOLOGICAL EVIDENCE AND SO MAY VARY FROM THAT SHOWN.



**TERWILLEGAR DRIVE UPGRADING STAGE 2
RAINBOW VALLEY BRIDGES WIDENING AND
SHARED USE PATH BRIDGE**

**STRATIGRAPHIC CROSS - SECTIONS
E1 - E1' AND E2 - E2'**

DWG No. 30442-RVB-3

DRAWN BY	ML
DESIGNED BY	MG
APPROVED BY	TME
SCALE	1:500
DATE	JUNE 2021
FILE No.	30442



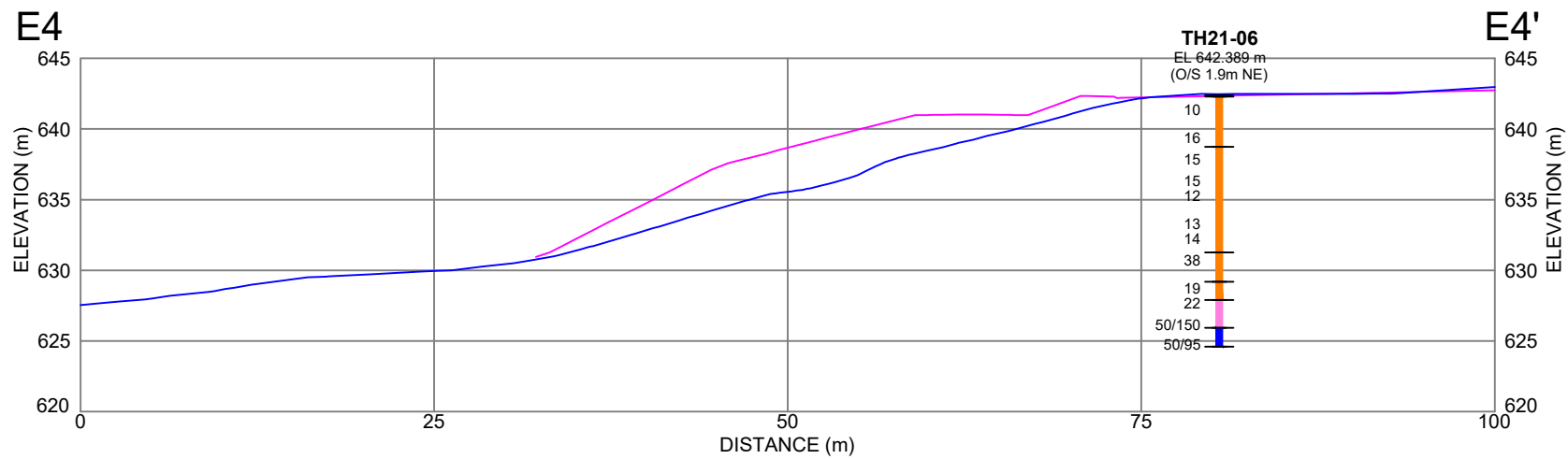
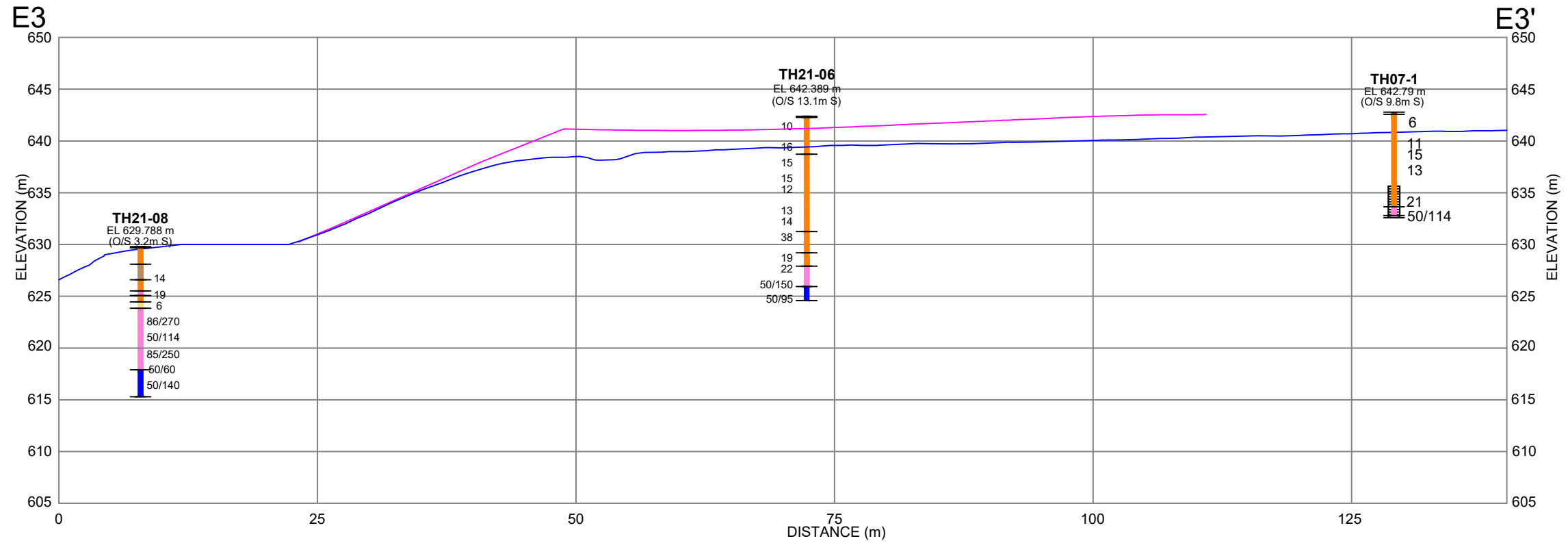

LEGEND

- SPT N VALUE
- WATER LEVEL IN PIEZOMETER (MAY 10, 2021)
- VIBRATING WIRE PIEZOMETER TIP
- STANDPIPE PIEZOMETER SCREENED INTERVAL
- DESIGN GRADE (PROVIDED BY CIMA+, JUNE 14, 2021)
- GROUND SURFACE PROFILE FROM 2019 LIDAR
- TOPSOIL
- FILL
- CLAY
- CLAY TILL
- SAND, GRAVEL
- SILT
- NO RECOVERY
- CLAY SHALE
- SANDSTONE

NOTE

DATA CONCERNING THE VARIOUS STRATA HAVE BEEN OBTAINED AT THE TEST HOLE LOCATIONS ONLY. THE SOIL STRATIGRAPHY BETWEEN TEST HOLES HAS BEEN INFERRED FROM GEOLOGICAL EVIDENCE AND SO MAY VARY FROM THAT SHOWN.



**TERWILLEGAR DRIVE UPGRADING STAGE 2
RAINBOW VALLEY BRIDGES WIDENING AND
SHARED USE PATH BRIDGE**

**STRATIGRAPHIC CROSS - SECTIONS
E3 - E3 AND E4 - E4'**

DWG No. 30442-RVB-4

DRAWN BY	ML
DESIGNED BY	MG
APPROVED BY	TME
SCALE	1:500
DATE	JUNE 2021
FILE No.	30442



THURBER ENGINEERING LTD.

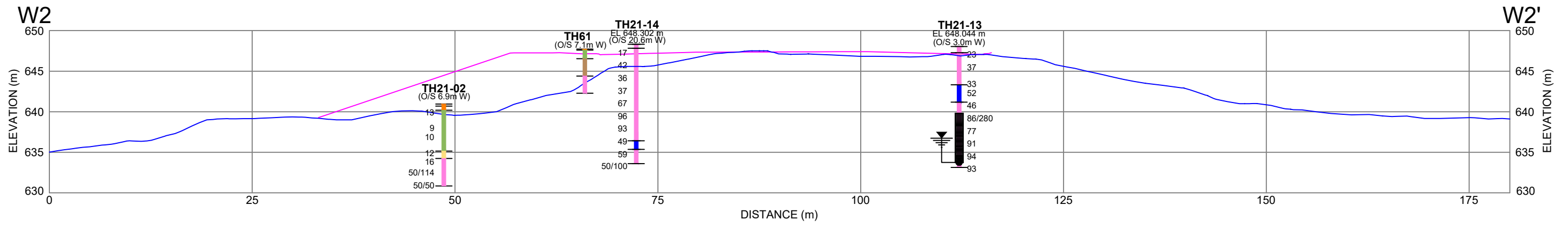
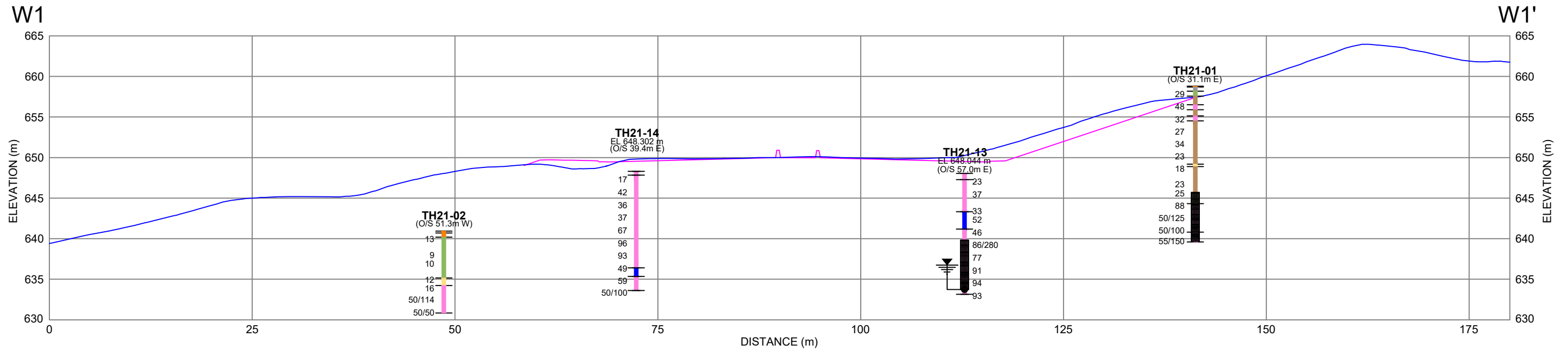

LEGEND

- SPT N VALUE
- WATER LEVEL IN PIEZOMETER (MAY 10, 2021)
- VIBRATING WIRE PIEZOMETER TIP
- STANDPIPE PIEZOMETER SCREENED INTERVAL
- DESIGN GRADE (PROVIDED BY CIMA+, JUNE 14, 2021)
- GROUND SURFACE PROFILE FROM 2019 LIDAR

- TOPSOIL
- FILL
- CLAY
- CLAY TILL
- SAND, GRAVEL
- SILT
- NO RECOVERY
- CLAY SHALE
- SANDSTONE

NOTE

DATA CONCERNING THE VARIOUS STRATA HAVE BEEN OBTAINED AT THE TEST HOLE LOCATIONS ONLY. THE SOIL STRATIGRAPHY BETWEEN TEST HOLES HAS BEEN INFERRED FROM GEOLOGICAL EVIDENCE AND SO MAY VARY FROM THAT SHOWN.

**TERWILLEGAR DRIVE UPGRADING STAGE 2
RAINBOW VALLEY BRIDGES WIDENING AND
SHARED USE PATH BRIDGE**

**STRATIGRAPHIC CROSS - SECTIONS
W1 - W1' AND W2 - W2'**

DWG No. 30442-RVB-5

DRAWN BY	ML
DESIGNED BY	MG
APPROVED BY	TME
SCALE	1:500
DATE	JUNE 2021
FILE No.	30442

THURBER ENGINEERING LTD.

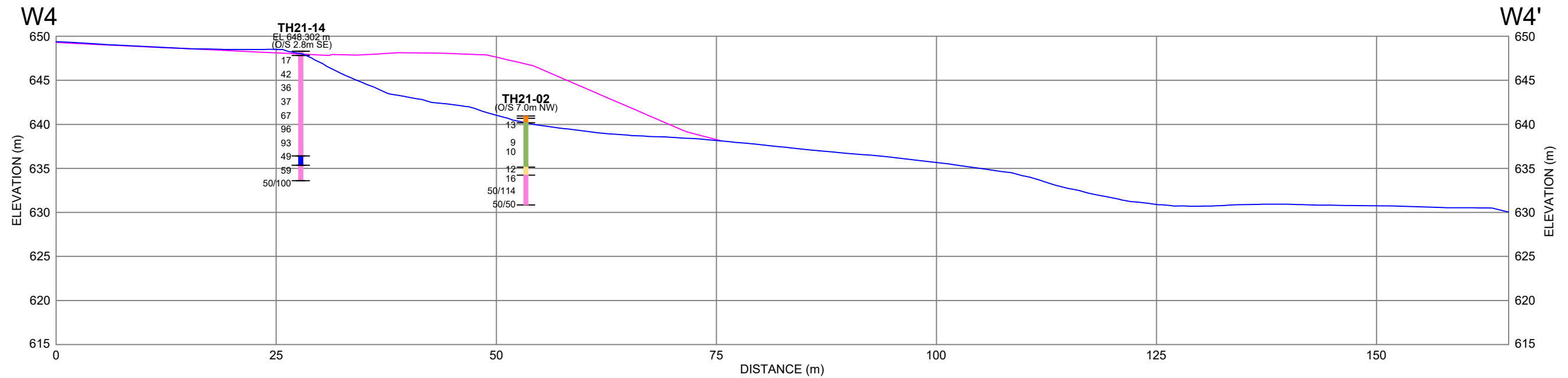
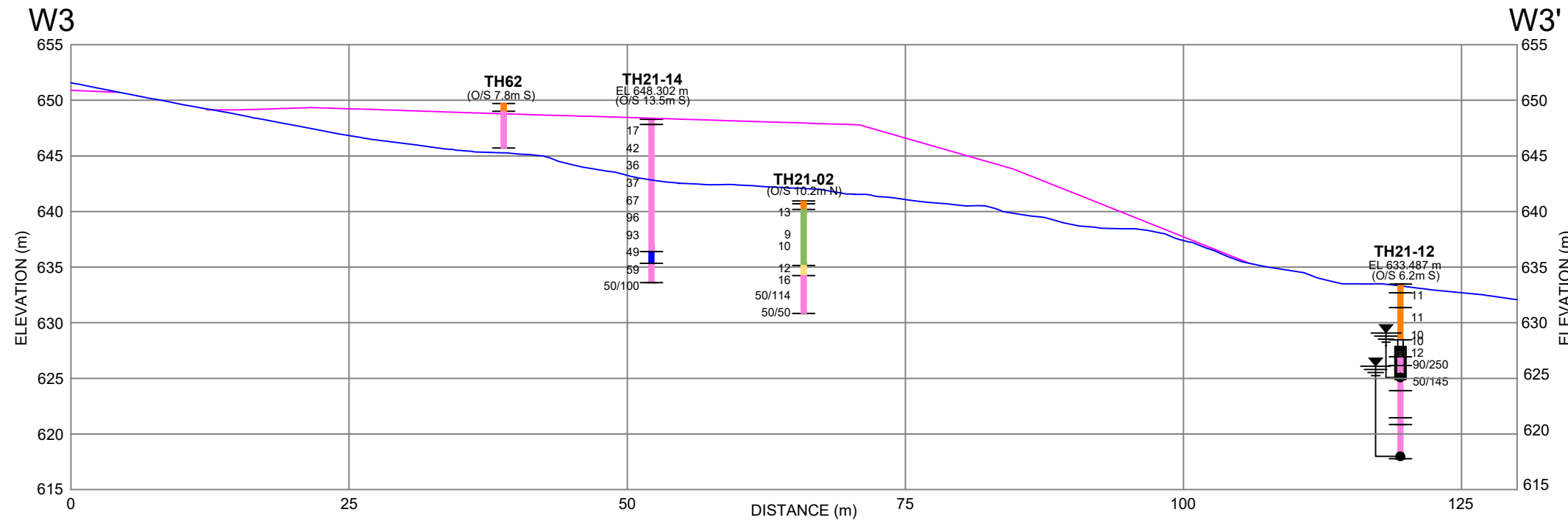

LEGEND

- SPT N VALUE
- WATER LEVEL IN PIEZOMETER (MAY 10, 2021)
- VIBRATING WIRE PIEZOMETER TIP
- STANDPIPE PIEZOMETER SCREENED INTERVAL
- DESIGN GRADE (PROVIDED BY CIMA+, JUNE 14, 2021)
- GROUND SURFACE PROFILE FROM 2019 LIDAR

- TOPSOIL
- FILL
- CLAY
- CLAY TILL
- SAND, GRAVEL
- SILT
- NO RECOVERY
- CLAY SHALE
- SANDSTONE

NOTE

DATA CONCERNING THE VARIOUS STRATA HAVE BEEN OBTAINED AT THE TEST HOLE LOCATIONS ONLY. THE SOIL STRATIGRAPHY BETWEEN TEST HOLES HAS BEEN INFERRED FROM GEOLOGICAL EVIDENCE AND SO MAY VARY FROM THAT SHOWN.



**TERWILLEGAR DRIVE UPGRADING STAGE 2
RAINBOW VALLEY BRIDGES WIDENING AND
SHARED USE PATH BRIDGE**

**STRATIGRAPHIC CROSS - SECTIONS
W3 - W3' AND W4 - W4'**

DWG No. 30442-RVB-6

DRAWN BY	ML
DESIGNED BY	MG
APPROVED BY	TME
SCALE	1:500
DATE	JUNE 2021
FILE No.	30442



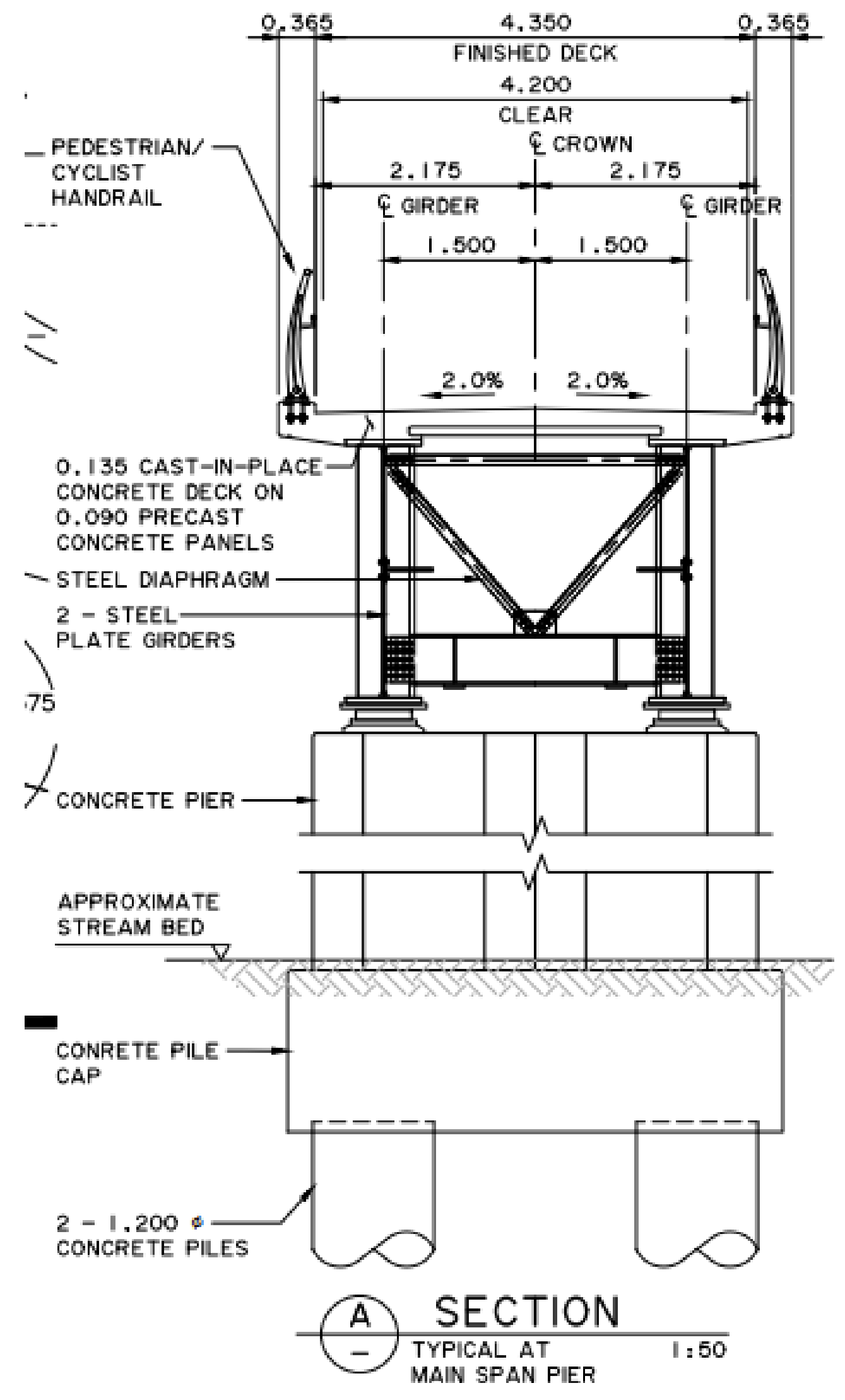
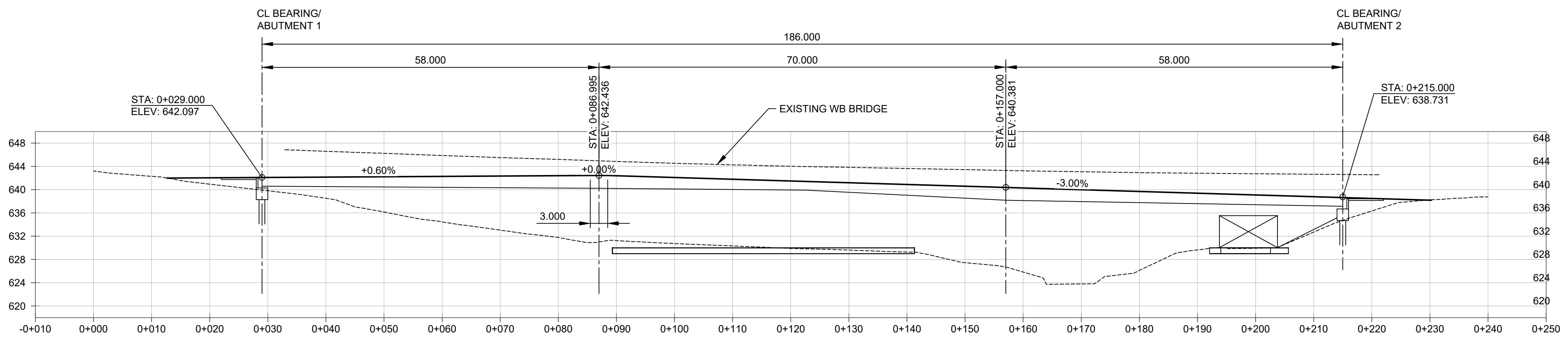
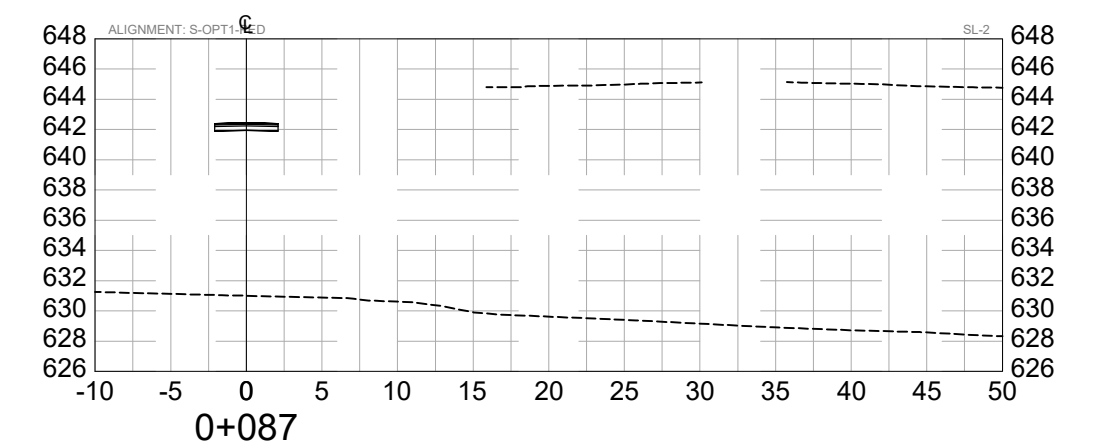
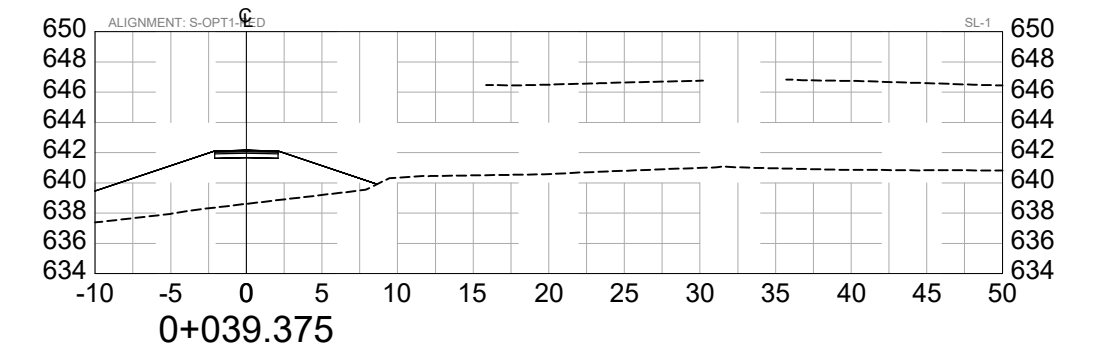
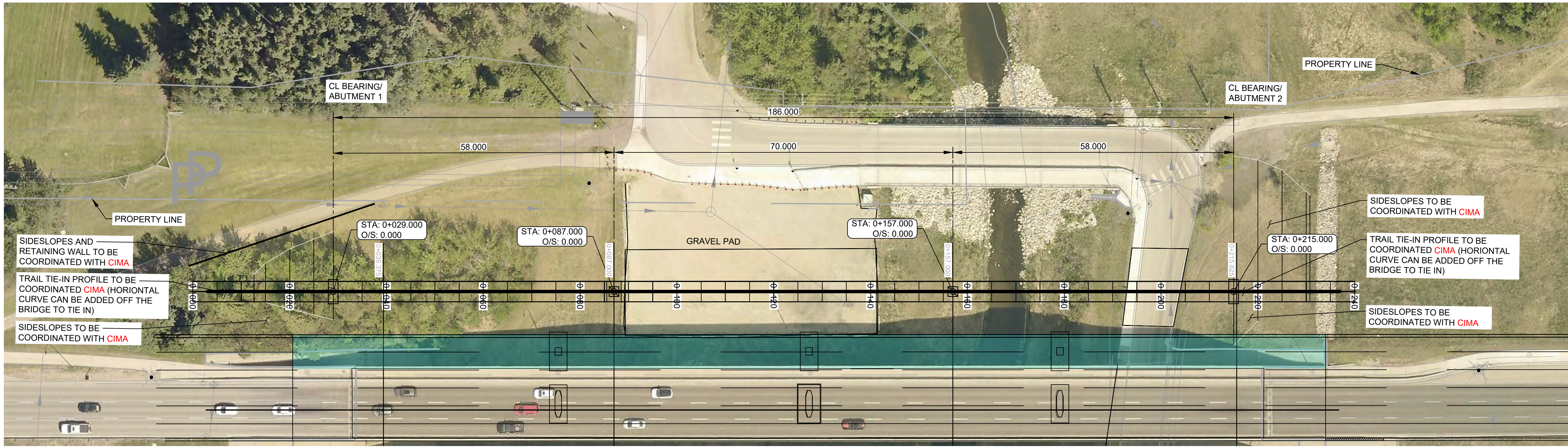

OPTION 1 - STEEL HAUNCH GIRDER

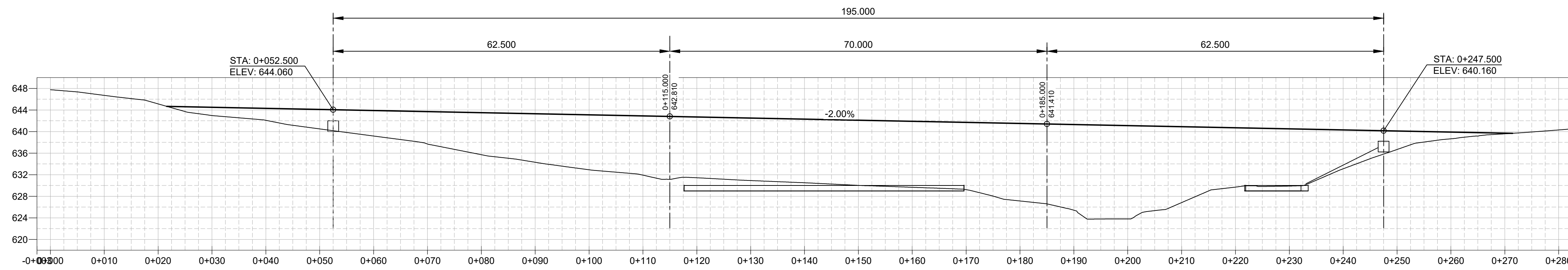
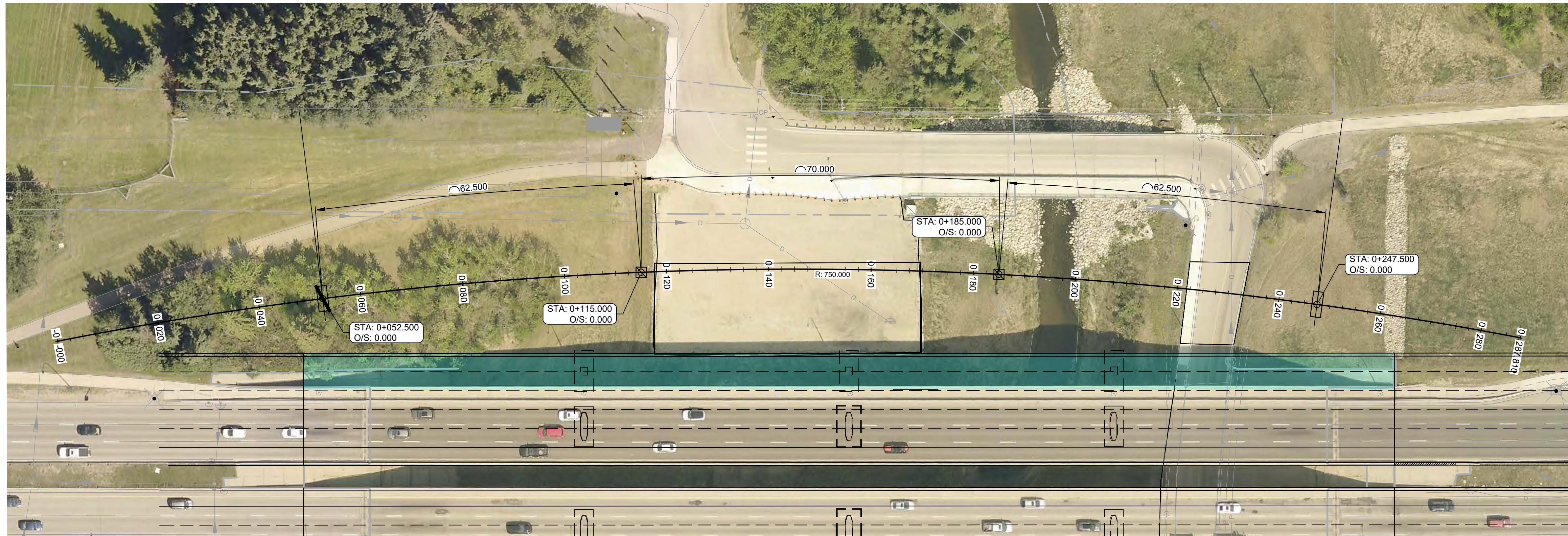

OPTION 2 - STEEL TRAPEZOID CURVED GIRDER



APPENDIX B

Modified Unified Soils Classification
Symbols and Terms Used on Test Hole Logs
Test Hole Logs (2021)

SYMBOLS AND TERMS USED ON TEST HOLE LOGS

1. VISUAL TEXTURAL CLASSIFICATION OF MINERAL SOILS

<u>CLASSIFICATION</u>	<u>APPARENT PARTICLE SIZE</u>	<u>VISUAL IDENTIFICATION</u>
Boulders	Greater than 200 mm	Greater than 200 mm
Cobbles	75 mm to 200 mm	75 mm to 200 mm
Gravel	4.75 mm to 75 mm	5 mm to 75 mm
Sand	0.075 mm to 4.75 mm	Visible particles to 5 mm
Silt	0.002 mm to 0.075 mm	Non-Plastic particles, not visible to the naked eye
Clay	Less than 0.002 mm	Plastic particles, not visible to the naked eye

2. TERMS DESCRIBING CONSISTENCY (COHESIVE SOILS ONLY)

<u>DESCRIPTIVE TERM</u>	<u>APPROXIMATE UNDRAINED SHEAR STRENGTH</u>	<u>APPROXIMATE SPT * 'N' VALUE</u>
Very Soft	Less than 10 kPa	Less than 2
Soft	10 - 25 kPa	2 to 4
Firm	25 - 50 kPa	4 to 8
Stiff	50 - 100 kPa	8 to 15
Very Stiff	100 - 200 kPa	15 to 30
Hard	200 - 300 kPa	Greater than 30
Very Hard	Greater than 300 kPa	

} Modified from National Building Code

* SPT 'N' Value Standard Penetration Test 'N' Value - refers to the number of blows from a 63.5 kg hammer free falling a height of 0.76m to advance a standard 50mm outside diameter split spoon sampler for 0.3m depth into the undrilled portion of the test hole.





3. TERMS DESCRIBING DENSITY (COHESIONLESS SOILS ONLY)

<u>DESCRIPTIVE TERM</u>	<u>STANDARD PENETRATION TEST (SPT) (Number of Blows per 300 mm)</u>
Very Loose	0 - 4
Loose	4 - 10
Compact	10 - 30
Dense	30 - 50
Very Dense	Over 50

} Modified from National Building Code

4. LEGEND FOR TEST HOLE LOGS

SYMBOL FOR SAMPLE TYPE

 Shelby Tube	 SPT	 No Recovery	 A-Casing	 Grab	 Core
---	---	---	--	--	--

SYMBOLS USED FOR TEST HOLE LOGS

●	WC - Water Content (% by weight) of soil sample
▼	Water Level
■	SPT Standard Penetration Test 'N' Value (Blows/300mm)
▲	CPen Shear Strength determined by pocket penetrometer
CVane	Shear Strength determined by pocket vane
Cu	Undrained Shear Strength determined by unconfined compression test
SO ₄ %	Percent (%) of water soluble sulphate ions

TERMS DESCRIBING QUANTITIES

'and'	35% to 50% of each size group
'sandy'	20% to 35%
'some'	10% to 20%
'trace'	Less than 10%
'mixture'	Soils containing three or more size groups within 20% of each other and each group greater than 10%

MODIFIED UNIFIED CLASSIFICATION SYSTEM FOR SOILS

(MODIFIED BY PFRA, 1985)

MAJOR DIVISION		GROUP SYMBOL	THURBER LOG SYMBOL	TYPICAL DESCRIPTION	LABORATORY CLASSIFICATION CRITERIA	
COARSE-GRAINED SOILS (MORE THAN HALF BY WEIGHT LARGER THAN 75µm)	GRAVELS MORE THAN HALF COARSE GRAINS LARGER THAN 4.75mm	GW	▲ ▼ ▲	WELL GRADED GRAVELS, GRAVEL-SAND MIXTURES, LITTLE OR NO FINES	$C_u = \frac{D_{60}}{D_{10}} > 4; C_c = \frac{(D_{30})^2}{D_{10} \times D_{60}} = 1 \text{ to } 3$ NOT MEETING ALL GRADATION REQUIREMENTS FOR GW ATTERBERG LIMITS BELOW "A" LINE I_p LESS THAN 4 ATTERBERG LIMITS ABOVE "A" LINE I_p MORE THAN 7 $C_u = \frac{D_{60}}{D_{10}} > 6; C_c = \frac{(D_{30})^2}{D_{10} \times D_{60}} = 1 \text{ to } 3$ NOT MEETING ALL GRADATION REQUIREMENTS FOR SW ATTERBERG LIMITS BELOW "A" LINE I_p LESS THAN 4 ATTERBERG LIMITS ABOVE "A" LINE I_p MORE THAN 7	
		GP	▲▲▲▲▲	POORLY GRADED GRAVELS, GRAVEL-SAND MIXTURES, LITTLE OR NO FINES		
		GRAVELS WITH FINES (APPRECIABLE AMOUNT OF FINES)	GM	▲▲▲▲▲		SILTY GRAVELS, GRAVEL-SAND-SILT MIXTURES
			GC	▲▲▲▲▲		CLAYEY GRAVELS, GRAVEL-SAND-CLAY MIXTURES
	SANDS MORE THAN HALF COARSE GRAINS SMALLER THAN 4.75mm	SW	● ● ● ● ●	WELL GRADED SANDS, GRAVELLY-SANDS, LITTLE OR NO FINES		
		SP	○○○○○	POORLY GRADED SANDS, GRAVELLY SANDS, LITTLE OR NO FINES		
		SAND WITH FINES (APPRECIABLE AMOUNT OF FINES)	SM	○○○○○		SILTY SANDS, SAND-SILT MIXTURES
			SC	○○○○○		CLAYEY SANDS, SAND-CLAY MIXTURES
		SILTS BELOW "A" LINE NEGLECTIBLE ORGANIC CONTENT	ML			INORGANIC SILTS AND VERY FINE SANDS, ROCK FLOUR, SILTY OR CLAYEY FINE SANDS OR CLAYEY SILTS WITH SLIGHT PLASTICITY
			MH			INORGANIC SILTS, MICACEOUS OR DIATOMACEOUS, FINE SANDY OR SILTY SOILS
CLAYS ABOVE "A" LINE NEGLECTIBLE ORGANIC CONTENT	CL		INORGANIC CLAYS OF LOW PLASTICITY, GRAVELLY, SANDY, OR SILTY CLAYS, LEAN CLAYS			
	CI		INORGANIC CLAYS OF MEDIUM PLASTICITY, GRAVELLY CLAYS, SANDY CLAYS, SILTY CLAYS			
	CH		INORGANIC CLAYS OF HIGH PLASTICITY, FAT CLAYS			
	ORGANIC SILTS & CLAYS BELOW "A" LINE	OL		ORGANIC SILTS AND ORGANIC SILTY CLAYS OF LOW AND MEDIUM PLASTICITY		
		OH		ORGANIC CLAYS OF HIGH PLASTICITY, ORGANIC SILTS		
HIGHLY ORGANIC SOILS		Pt	PEAT AND OTHER HIGHLY ORGANIC SOILS	STRONG COLOR OR ODOR, AND OFTEN FIBROUS TEXTURE		

Determine percentages of gravel and sand from grain size curve. Depending on percentages of fines (fraction smaller than 75µm) coarse grained soils are classified as follows:
 Less than 5% GW, GP, SW, SP
 More than 5% GM, GC, SM, SC
 5% to 12% Borderline cases requiring use of dual symbols

CLASSIFICATION IS BASED UPON PLASTICITY CHART (see below)

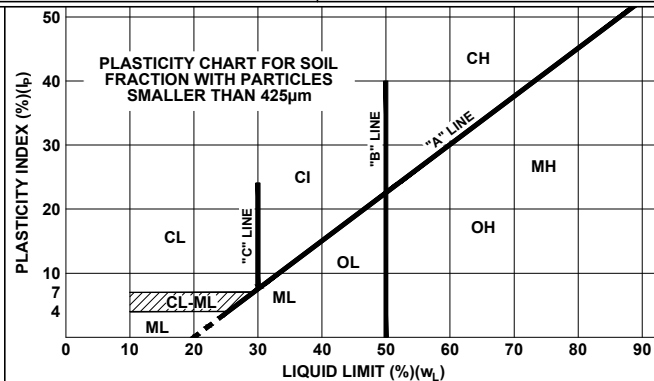
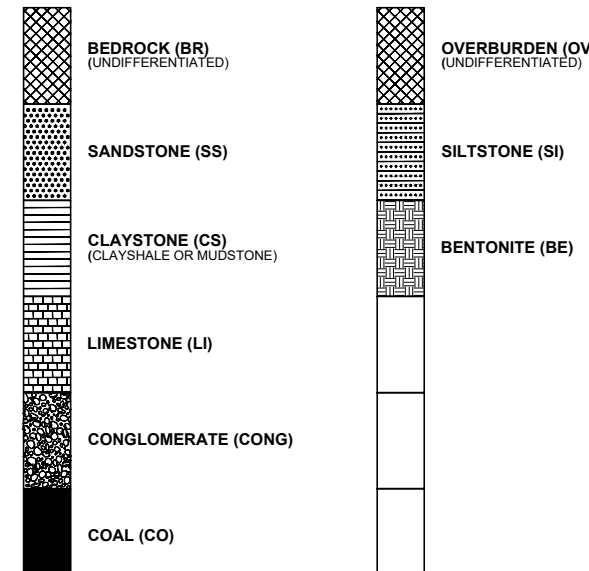

MODIFIED UNIFIED CLASSIFICATION SYSTEM FOR SOILS

(MODIFIED BY PFRA, 1985)

CLIENT: CIMA+	PROJECT: TERWILLEGAR DRIVE UPGRADING STAGE 2	BOREHOLE NO: TH21-01
DRILLING COMPANY: ALL SERVICE DRILLING INC	DATE DRILLED: July 31, 2021	PROJECT NO: 30442
DRILL/METHOD: CME55 Track / Solid Stem Augers	LOCATION: N5927770.093, E29353.716	ELEVATION: 658.79 (m)

SAMPLE TYPE	<input type="checkbox"/> GRAB SAMPLE	<input checked="" type="checkbox"/> SPT	<input type="checkbox"/> SHELBY TUBE
BACKFILL TYPE	<input checked="" type="checkbox"/> BENTONITE	<input checked="" type="checkbox"/> DRILL CUTTINGS	

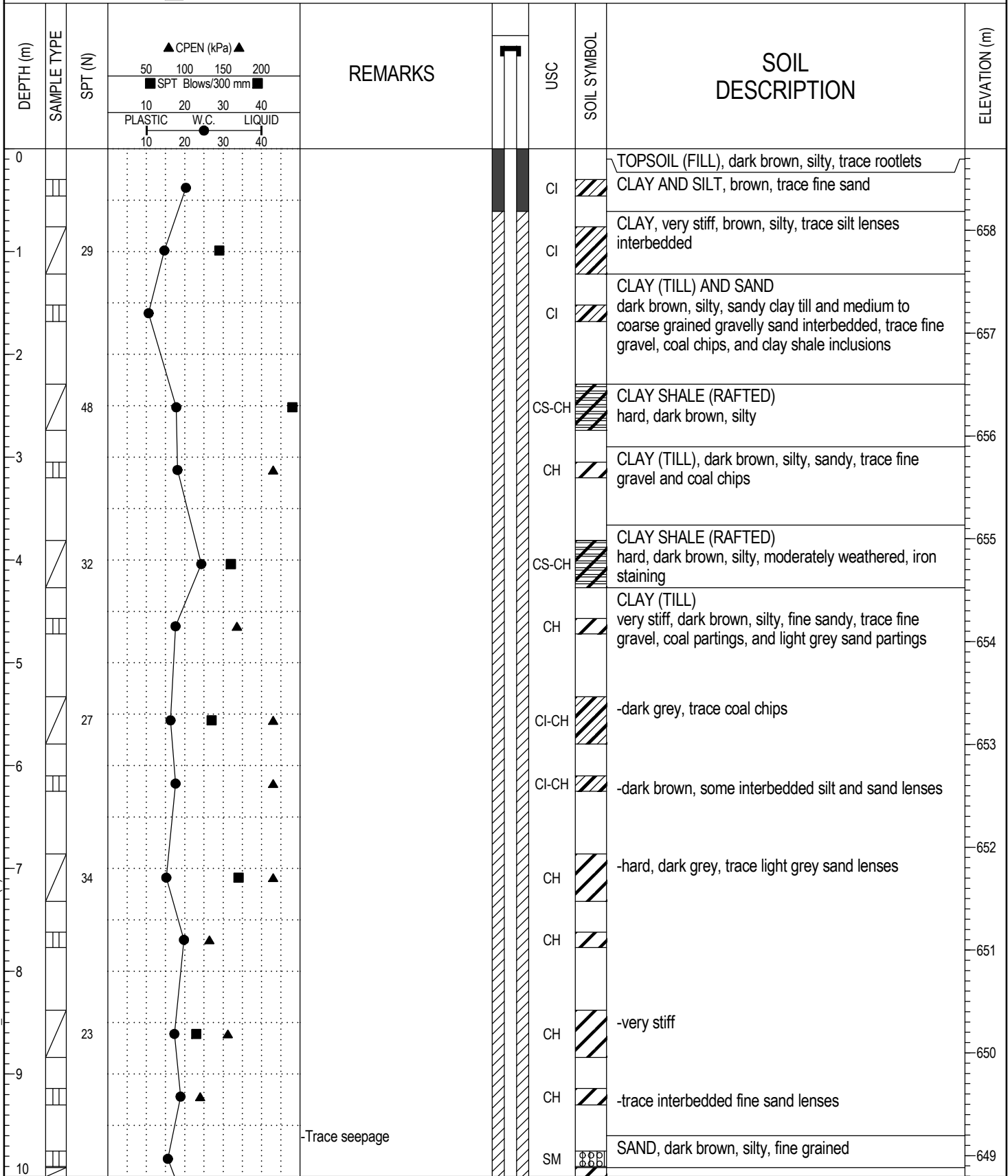

-Trace seepage

FIELD LOGGED BY: TDC	COMPLETION DEPTH: 19.2 m
PREPARED BY: MG	COMPLETION DATE: 2021-07-31
REVIEWED BY: TME	



BOREHOLE LOG 30442-VW-GPJ_THRBR_AB.GDT_21-8-25_COPY (2) OF LIBRARY-NEW.LOGO.GLB

CLIENT: CIMA+	PROJECT: TERWILLEGAR DRIVE UPGRADING STAGE 2	BOREHOLE NO: TH21-01
DRILLING COMPANY: ALL SERVICE DRILLING INC	DATE DRILLED: July 31, 2021	PROJECT NO: 30442
DRILL/METHOD: CME55 Track / Solid Stem Augers	LOCATION: N5927770.093, E29353.716	ELEVATION: 658.79 (m)

SAMPLE TYPE	<input type="checkbox"/> GRAB SAMPLE	<input checked="" type="checkbox"/> SPT	<input checked="" type="checkbox"/> SHELBY TUBE
BACKFILL TYPE	<input checked="" type="checkbox"/> BENTONITE	<input checked="" type="checkbox"/> DRILL CUTTINGS	

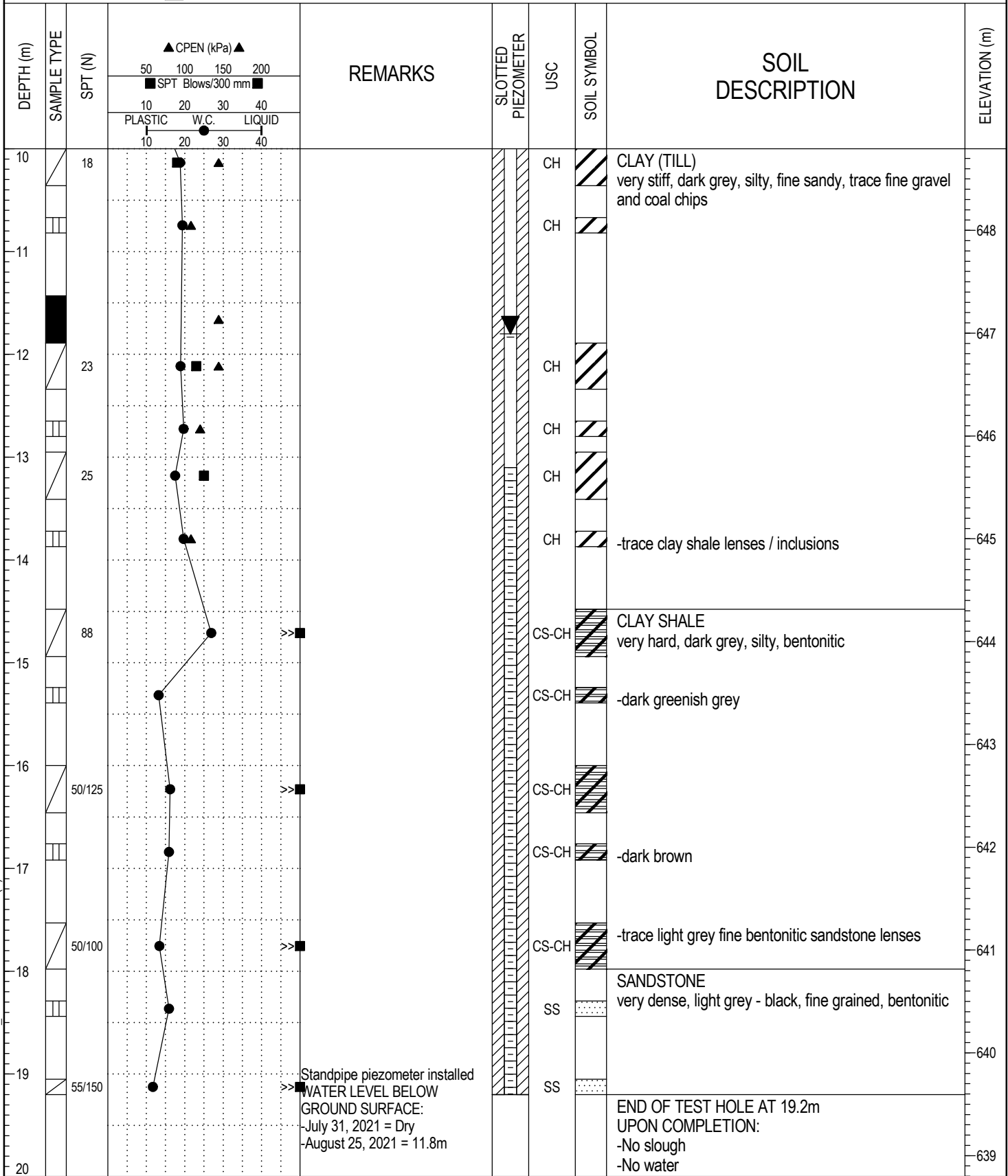

BOREHOLE LOG 30442-VW-GPJ_THRBR_AB.GDT_21-8-25_COPY (2) OF LIBRARY-NEW.LOGO.GLB



FIELD LOGGED BY: TDC	COMPLETION DEPTH: 19.2m
PREPARED BY: MG	COMPLETION DATE: 2021-07-31
REVIEWED BY: TME	

CLIENT: CIMA+	PROJECT: TERWILLEGAR DRIVE UPGRADING STAGE 2	BOREHOLE NO: TH21-02
DRILLING COMPANY: ALL SERVICE DRILLING INC	DATE DRILLED: July 30, 2021	PROJECT NO: 30442
DRILL/METHOD: CME55 Track / Solid Stem Augers	LOCATION: N5927862.713, E29437.89	ELEVATION: 640.94 (m)
SAMPLE TYPE <input type="checkbox"/> GRAB SAMPLE <input checked="" type="checkbox"/> SPT <input type="checkbox"/> SHELBY TUBE		

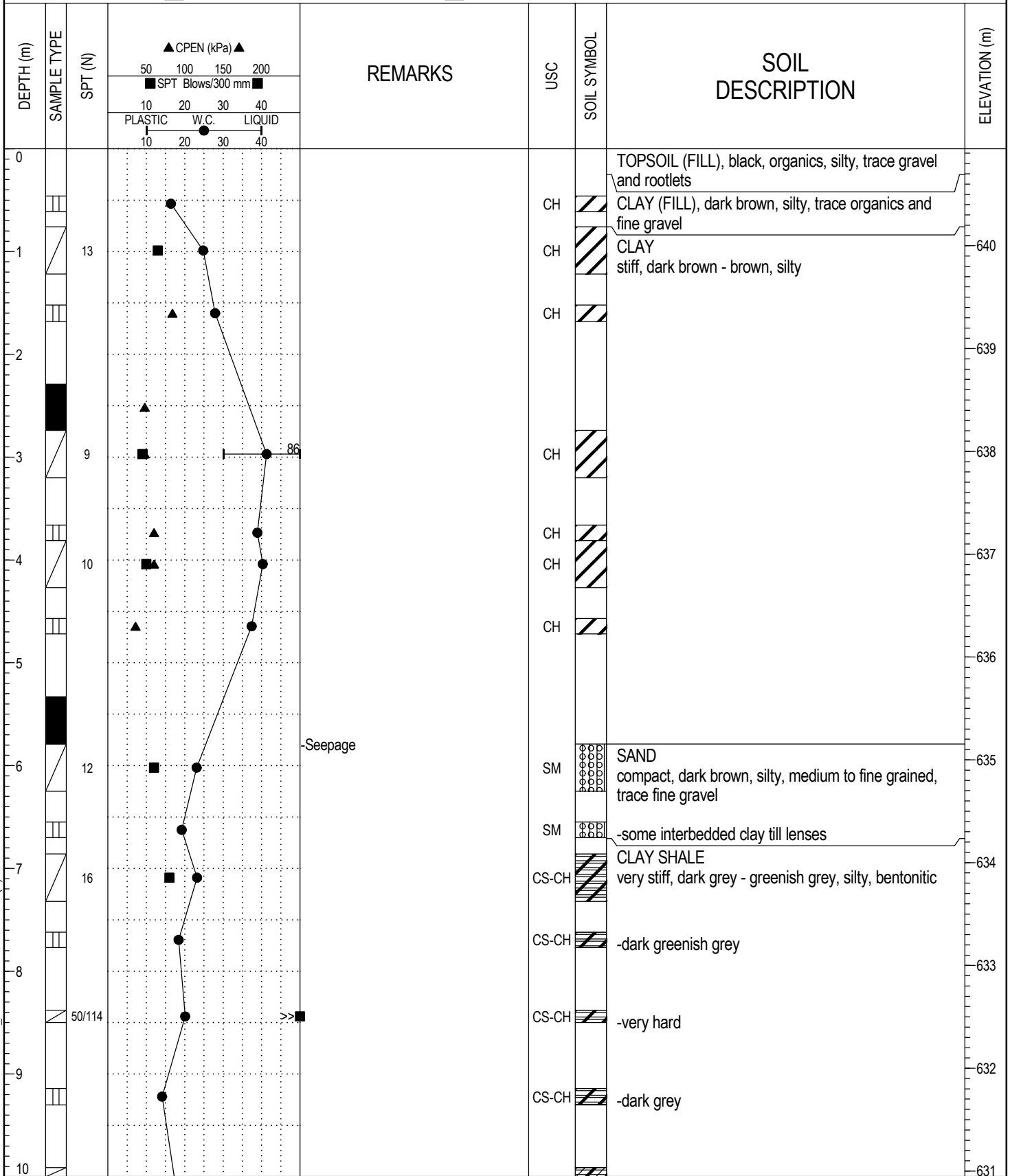

BOREHOLE LOG 30442-VW.GPJ_THRBR_AB.GDT_21-9-17_COPY (2) OF LIBRARY-NEW.LOGO.GLB



FIELD LOGGED BY: TDC	COMPLETION DEPTH: 10.1 m
PREPARED BY: MG	COMPLETION DATE: 2021-07-30
REVIEWED BY: TME	

CLIENT: CIMA+	PROJECT: TERWILLEGAR DRIVE UPGRADING STAGE 2	BOREHOLE NO: TH21-02
DRILLING COMPANY: ALL SERVICE DRILLING INC	DATE DRILLED: July 30, 2021	PROJECT NO: 30442
DRILL/METHOD: CME55 Track / Solid Stem Augers	LOCATION: N5927862.713, E29437.89	ELEVATION: 640.94 (m)
SAMPLE TYPE <input type="checkbox"/> GRAB SAMPLE <input checked="" type="checkbox"/> SPT <input type="checkbox"/> SHELBY TUBE		

DEPTH (m)	SAMPLE TYPE	SPT (N)	CPEN (kPa) ▲		REMARKS	USC	SOIL SYMBOL	SOIL DESCRIPTION	ELEVATION (m)											
			50	100						150	200									
10		50/50	10	20	30	40	PLASTIC	W.C.	LIQUID											
11																				630
12																				629
13																				628
14																				627
15																				626
16																				625
17																				624
18																				623
19																				622
20																				621

END OF TEST HOLE AT 10.1m
UPON COMPLETION: (Below ground surface)
-Squeezing in at 6.1m
-Water at 6.1m
Backfilled with drill cuttings and bentonite chips at surface

BOREHOLE LOG 30442-VW.GPJ_THRBR_AB.GDT_21-9-17_COPY (2) OF LIBRARY-NEW.LOGO.GLB



FIELD LOGGED BY: TDC	COMPLETION DEPTH: 10.1 m
PREPARED BY: MG	COMPLETION DATE: 2021-07-30
REVIEWED BY: TME	

CLIENT: CIMA+ PROJECT: TERWILLEGAR DRIVE UPGRADING STAGE 2 BOREHOLE NO: TH21-03

DRILLING COMPANY: ALL SERVICE DRILLING INC DATE DRILLED: April 8, 2021 PROJECT NO: 30442

DRILL/METHOD: D50 Track / Solid Stem Augers LOCATION: N5927766.765, E29735.487 ELEVATION: 635.56 (m)

SAMPLE TYPE GRAB SAMPLE SPT SHELBY TUBE NO RECOVERY

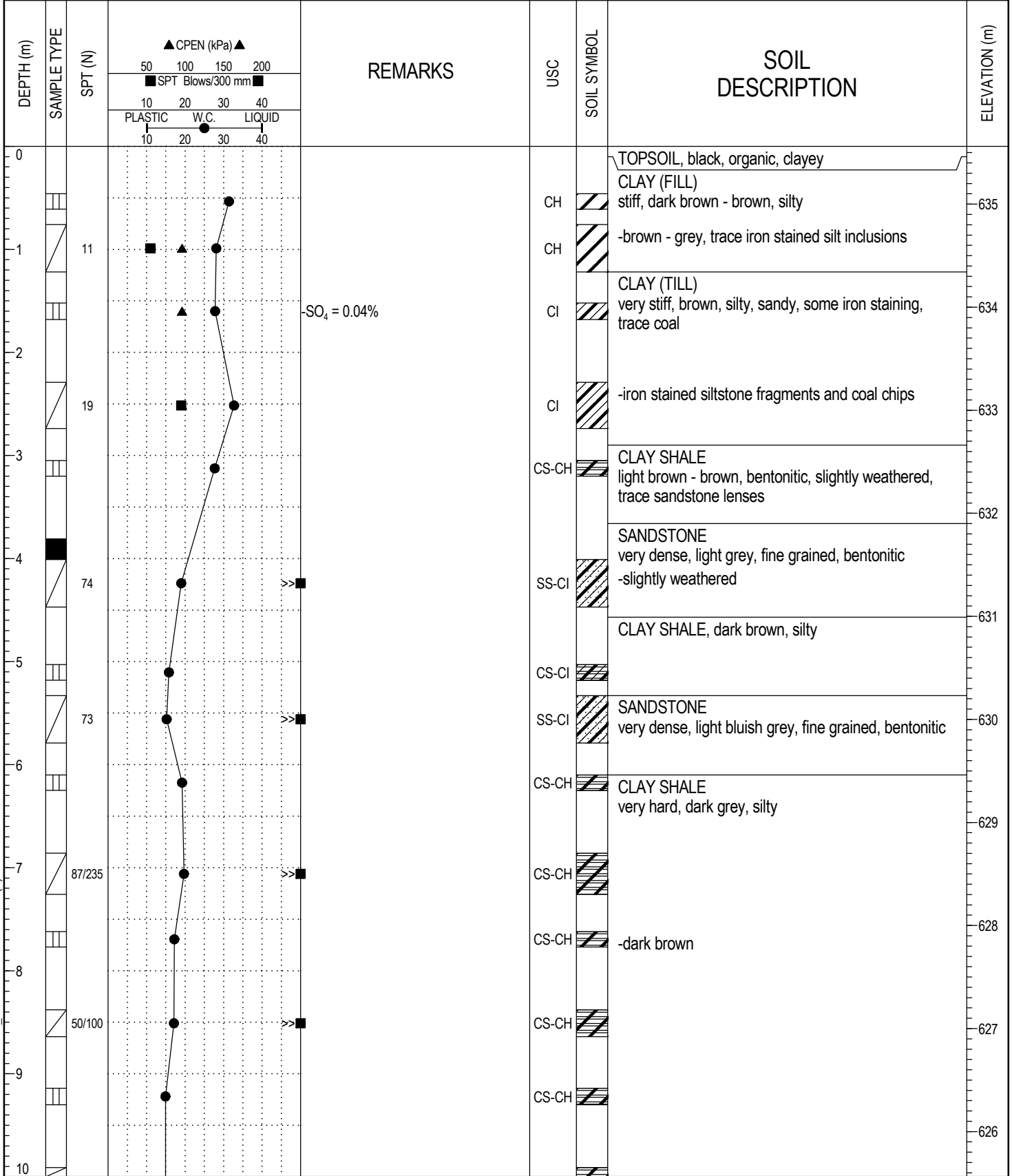

BOREHOLE LOG 30442-VW-GPJ_THRBR_AB.GDT_21-8-25_COPY (2) OF LIBRARY-NEW.LOGO.GLB



FIELD LOGGED BY: TDC	COMPLETION DEPTH: 14.6 m
PREPARED BY: MG	COMPLETION DATE: 2021-04-08
REVIEWED BY: TME	

CLIENT: CIMA+	PROJECT: TERWILLEGAR DRIVE UPGRADING STAGE 2	BOREHOLE NO: TH21-03
DRILLING COMPANY: ALL SERVICE DRILLING INC	DATE DRILLED: April 8, 2021	PROJECT NO: 30442
DRILL/METHOD: D50 Track / Solid Stem Augers	LOCATION: N5927766.765, E29735.487	ELEVATION: 635.56 (m)
SAMPLE TYPE <input type="checkbox"/> GRAB SAMPLE <input checked="" type="checkbox"/> SPT <input type="checkbox"/> SHELBY TUBE <input checked="" type="checkbox"/> NO RECOVERY		

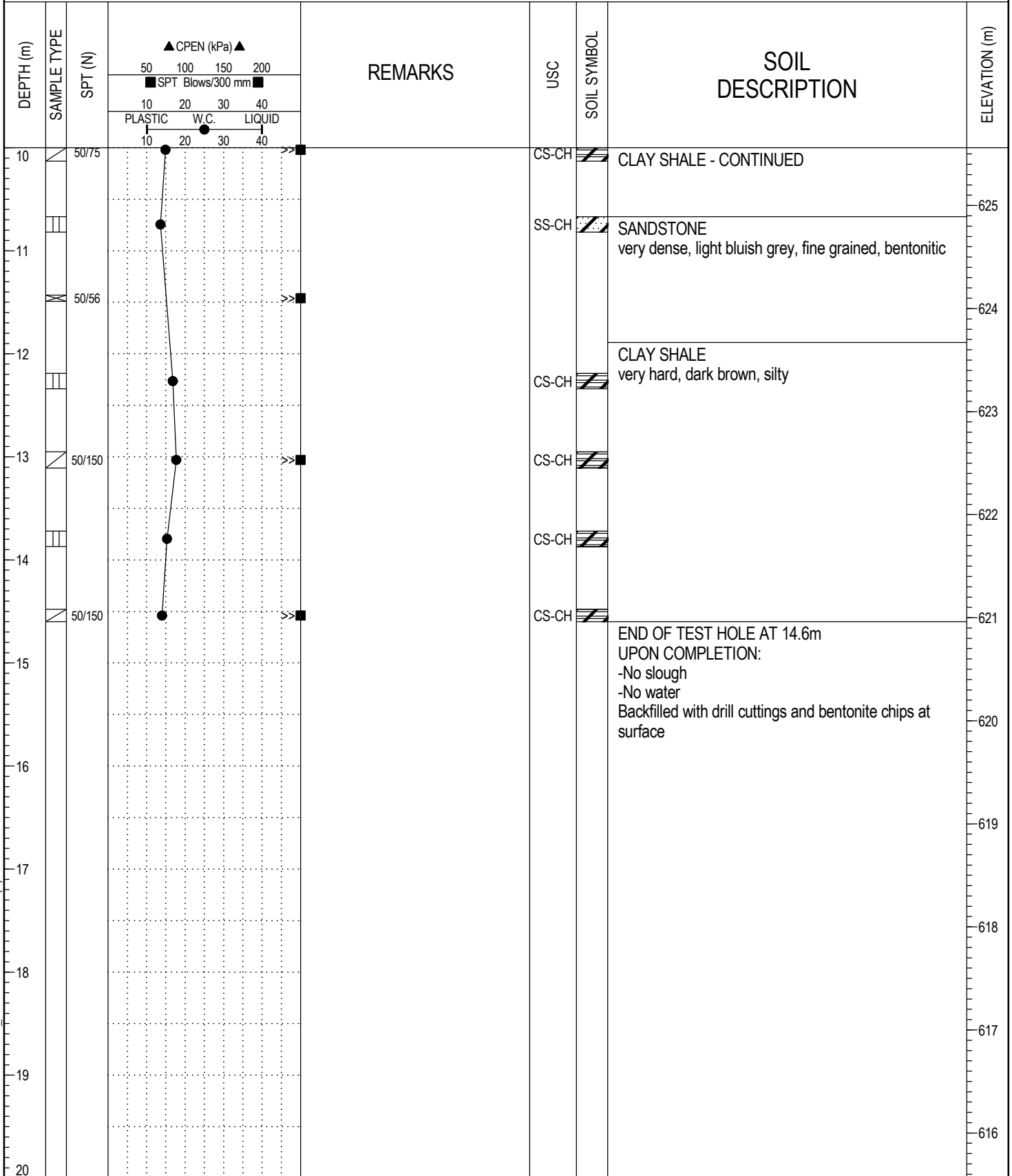

BOREHOLE LOG 30442-VW-GPJ_THRBR_AB.GDT_21-8-25_COPY (2) OF LIBRARY-NEW.LOGO.GLB



FIELD LOGGED BY: TDC	COMPLETION DEPTH: 14.6m
PREPARED BY: MG	COMPLETION DATE: 2021-04-08
REVIEWED BY: TME	

CLIENT: CIMA+		PROJECT: TERWILLEGAR DRIVE UPGRADING STAGE 2		BOREHOLE NO: TH21-04					
DRILLING COMPANY: ALL SERVICE DRILLING INC		DATE DRILLED: April 7, 2021		PROJECT NO: 30442					
DRILL/METHOD: D50 Track / Solid Stem Augers		LOCATION: N5927887.706, E29696.502		ELEVATION: 631.24 (m)					
SAMPLE TYPE		<input type="checkbox"/> GRAB SAMPLE	<input checked="" type="checkbox"/> SPT	<input checked="" type="checkbox"/> SHELBY TUBE					
BACKFILL TYPE		<input checked="" type="checkbox"/> BENTONITE	<input checked="" type="checkbox"/> DRILL CUTTINGS						
DEPTH (m)	SAMPLE TYPE	SPT (N)	REMARKS		SLOTTED PIEZOMETER	USC	SOIL SYMBOL	SOIL DESCRIPTION	ELEVATION (m)
			■ SPT Blows/300 mm ■ 10 20 30 40 PLASTIC W.C. LIQUID 10 20 30 40						
0								TOPSOIL, black, organic CLAY (FILL), dark brown, gravelly, trace coal	631
1		15					CS-CH	CLAY SHALE (FILL) very stiff, light greenish grey, silty, highly weathered	630
2							SS-CI	SANDSTONE light grey -dark brown, fine grained, bentonitic	629
3		65		-Gravel = 0%, Sand = 48.7% Silt = 31.8%, Clay = 19.5%			SS-CI	-very dense	628
4		86/235					SS-CI	SANDSTONE very dense, light bluish grey, fine grained, bentonitic	627
5							SI-CI		626
6		50/108					CS-CH	CLAY SHALE very hard, dark grey, silty	625
7		50/100					CS-CH		624
8							SS-CI	SANDSTONE very dense, dark brown - grey, fine grained	623
9		50/130					SS-CI		622
10							CS-CH	CLAY SHALE very hard, dark brown, silty	622

BOREHOLE LOG 30442-VW-GPJ_THRBR_AB_GDT_21-8-25_COPY (2) OF LIBRARY-NEW.LOGO.GLB



FIELD LOGGED BY: TDC	COMPLETION DEPTH: 14.6 m
PREPARED BY: MG	COMPLETION DATE: 2021-04-07
REVIEWED BY: TME	

CLIENT: CIMA+	PROJECT: TERWILLEGAR DRIVE UPGRADING STAGE 2	BOREHOLE NO: TH21-04
DRILLING COMPANY: ALL SERVICE DRILLING INC	DATE DRILLED: April 7, 2021	PROJECT NO: 30442
DRILL/METHOD: D50 Track / Solid Stem Augers	LOCATION: N5927887.706, E29696.502	ELEVATION: 631.24 (m)

SAMPLE TYPE	<input type="checkbox"/> GRAB SAMPLE	<input checked="" type="checkbox"/> SPT	<input type="checkbox"/> SHELBY TUBE
BACKFILL TYPE	<input checked="" type="checkbox"/> BENTONITE	<input checked="" type="checkbox"/> DRILL CUTTINGS	

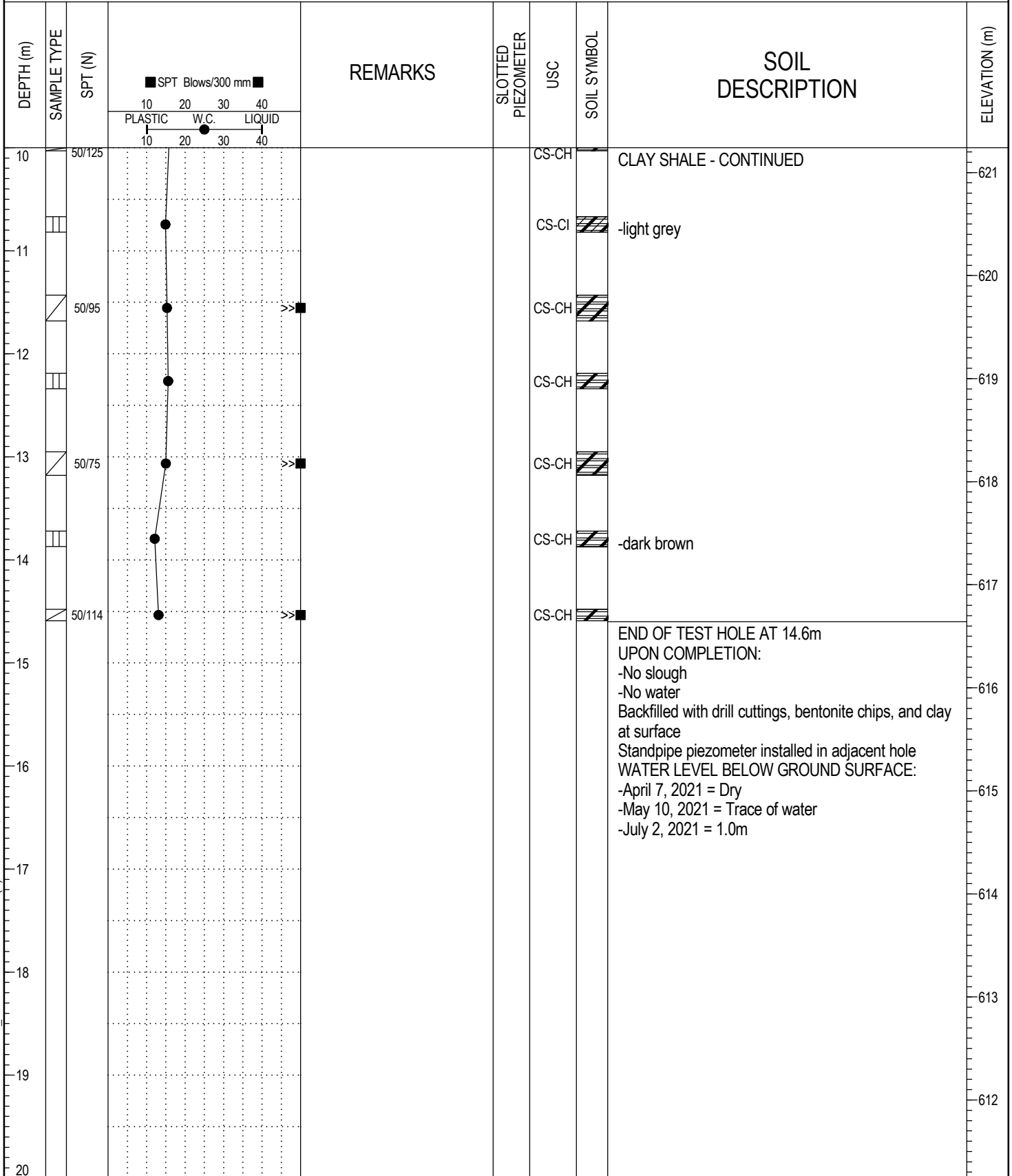

BOREHOLE LOG 30442-VW.GPJ_THRBR_AB.GDT_21-8-25_COPY (2) OF LIBRARY-NEW.LOGO.GLB



FIELD LOGGED BY: TDC	COMPLETION DEPTH: 14.6m
PREPARED BY: MG	COMPLETION DATE: 2021-04-07
REVIEWED BY: TME	

CLIENT: CIMA+		PROJECT: TERWILLEGAR DRIVE UPGRADING STAGE 2		BOREHOLE NO: TH21-05			
DRILLING COMPANY: ALL SERVICE DRILLING INC		DATE DRILLED: April 1, 2021		PROJECT NO: 30442			
DRILL/METHOD: D50 Track / Solid Stem Augers		LOCATION: N5927802.711, E29667.8		ELEVATION: 642.55 (m)			
SAMPLE TYPE		<input type="checkbox"/> GRAB SAMPLE <input checked="" type="checkbox"/> SPT <input checked="" type="checkbox"/> SHELBY TUBE					
BACKFILL TYPE		<input checked="" type="checkbox"/> BENTONITE <input checked="" type="checkbox"/> DRILL CUTTINGS					
DEPTH (m)	SAMPLE TYPE	SPT (N)	REMARKS	USC	SOIL SYMBOL	SOIL DESCRIPTION	ELEVATION (m)
0						CLAY (FILL) brown - dark brown, silty	642
0.8			-Frozen to 0.8m				
1.5				CH			
1.8				CH		CLAY TILL (FILL) dark brown, silty, sandy, trace coal chips and medium gravel	641
2.5				SM		SAND (FILL), compact, brown - black, medium to fine grained, silty, trace coal and organic inclusions	640
3.2				CH		CLAY (FILL) brown, silty, trace oxides	
3.5				CI		CLAY TILL (FILL) brown, silty, sandy, trace coal chips chips and topsoil partings	639
4.5				CH		CLAY (FILL) stiff, brown, silty, trace iron stained silt nodules / partings	638
5.5				CH			
5.8				CH			60
6.2				CH		-very stiff	637
6.5				CH		-dark brown - brown, trace silt partings	636
7.2				CI		CLAY TILL (FILL) very stiff, dark brown, silty, sandy, trace gravelly lenses	635
7.5				CI		-brown, fine sandy, trace fine gravel and coal chips	
8.5				CH		CLAY (FILL) very stiff, dark brown - brown, silty, trace silt partings	634
8.8				CH		-trace brown organic pieces	
9.2				CH			633
10							

BOREHOLE LOG 30442-VW-GPJ_THRBR_AB_GDT_21-8-25_COPY (2) OF LIBRARY-NEW.LOGO.GLB



FIELD LOGGED BY: TDC	COMPLETION DEPTH: 16.1 m
PREPARED BY: MG	COMPLETION DATE: 2021-04-01
REVIEWED BY: TME	

CLIENT: CIMA+		PROJECT: TERWILLEGAR DRIVE UPGRADING STAGE 2		BOREHOLE NO: TH21-05				
DRILLING COMPANY: ALL SERVICE DRILLING INC		DATE DRILLED: April 1, 2021		PROJECT NO: 30442				
DRILL/METHOD: D50 Track / Solid Stem Augers		LOCATION: N5927802.711, E29667.78		ELEVATION: 642.55 (m)				
SAMPLE TYPE		GRAB SAMPLE		SPT		SHELBY TUBE		
BACKFILL TYPE		BENTONITE		DRILL CUTTINGS				
DEPTH (m)	SAMPLE TYPE	SPT (N)	REMARKS	SLOTTED PIEZOMETER	USC	SOIL SYMBOL	SOIL DESCRIPTION	ELEVATION (m)
10		19				CH	CLAY (FILL) - CONTINUED -occasional root hairs	632
11						CH	-interbedded silt lenses	
12		23				CS-CH	CLAY SHALE (FILL), very stiff, dark greenish grey - grey, trace thin light brown bentonitic lenses	631
13						SS-CH	SANDSTONE AND CLAY SHALE (FILL), dark brown, fine grained sandstone and clay shale	
14		27				CI	CLAY (FILL), black, organic, silty, trace fine sand	630
15						CH	CLAY SHALE AND SANDSTONE (FILL), very stiff / compact, dark brown to black clay shale and brown iron stained fine grained sandstone, trace decayed wood fragments	629
16		39				CI	CLAY, dark brown, silty, fine sandy, trace coal chips / stringers	628
17						CI	-hard, grey - brown, iron staining, trace cemented iron stone and coal fragments	627
18		50/120				SS-CI	SANDSTONE light brown, fine grained, iron staining	626
19						SS-CI	-light grey - dark grey	625
20						SS-CI	-very dense, dark grey END OF TEST HOLE AT 16.1m UPON COMPLETION: -No slough -No water Standpipe piezometer installed WATER LEVEL BELOW GROUND SURFACE: -April 1, 2021 = 14.2m -May 10, 2021 = 11.8m -July 2, 2021 = 14.4m	624
▲ CPEN (kPa) ▲ 50 100 150 200 ■ SPT Blows/300 mm ■ 10 20 30 40 PLASTIC W.C. LIQUID 10 20 30 40				-SO ₄ = 0.02% -Seepage				

BOREHOLE LOG 30442-VW-GPJ_THRBR_AB.GDT_21-8-25_COPY (2) OF LIBRARY-NEW.LOGO.GLB



FIELD LOGGED BY: TDC
 PREPARED BY: MG
 REVIEWED BY: TME

COMPLETION DEPTH: 16.1 m
 COMPLETION DATE: 2021-04-01

CLIENT: CIMA+	PROJECT: TERWILLEGAR DRIVE UPGRADING STAGE 2	BOREHOLE NO: TH21-06
DRILLING COMPANY: ALL SERVICE DRILLING INC	DATE DRILLED: April 7, 2021	PROJECT NO: 30442
DRILL/METHOD: D50 Track / Solid Stem Augers	LOCATION: N5927843.662, E29677.015	ELEVATION: 642.39 (m)
SAMPLE TYPE <input type="checkbox"/> GRAB SAMPLE <input checked="" type="checkbox"/> SPT <input type="checkbox"/> SHELBY TUBE		

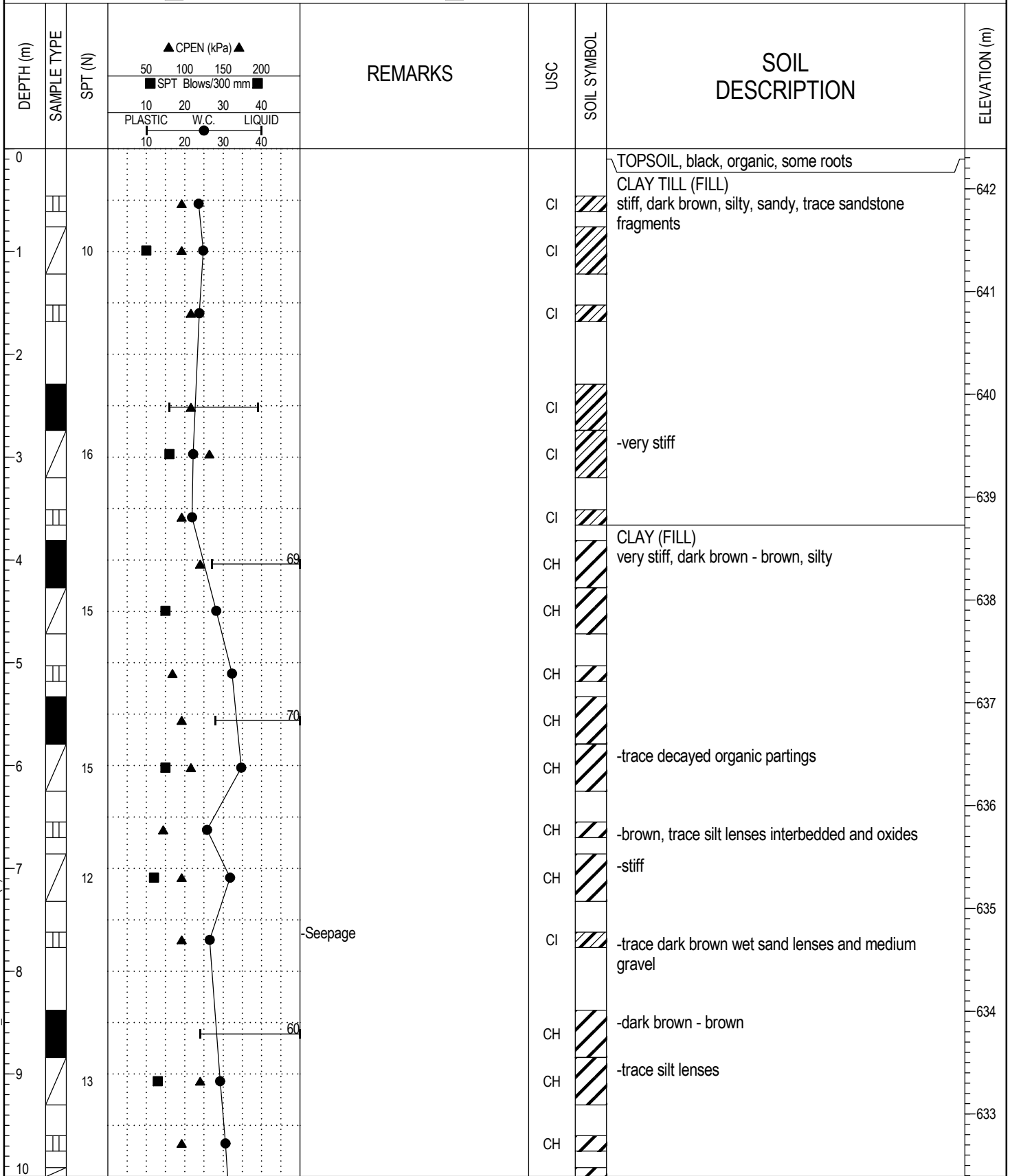

BOREHOLE LOG 30442-VW-GPJ_THRBR_AB_GDT_21-8-25_COPY (2) OF LIBRARY-NEW.LOGO.GLB



FIELD LOGGED BY: TDC	COMPLETION DEPTH: 17.8 m
PREPARED BY: MG	COMPLETION DATE: 2021-04-07
REVIEWED BY: TME	

CLIENT: CIMA+	PROJECT: TERWILLEGAR DRIVE UPGRADING STAGE 2	BOREHOLE NO: TH21-06
DRILLING COMPANY: ALL SERVICE DRILLING INC	DATE DRILLED: April 7, 2021	PROJECT NO: 30442
DRILL/METHOD: D50 Track / Solid Stem Augers	LOCATION: N5927843.662, E29677.015	ELEVATION: 642.39 (m)
SAMPLE TYPE <input type="checkbox"/> GRAB SAMPLE <input checked="" type="checkbox"/> SPT <input type="checkbox"/> SHELBY TUBE		

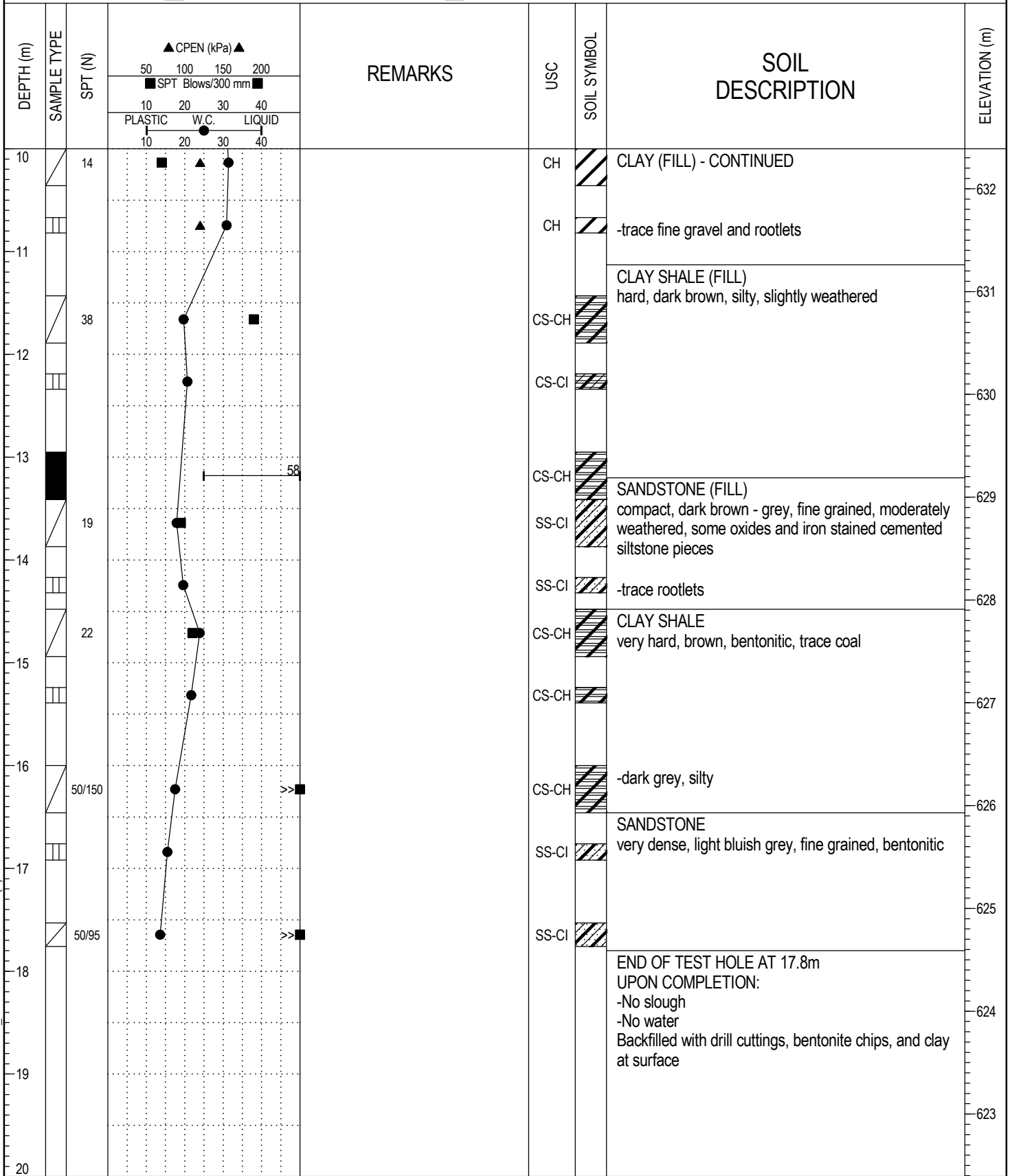

BOREHOLE LOG 30442-VW-GPJ_THRBR_AB.GDT_21-8-25_COPY (2) OF LIBRARY-NEW.LOGO.GLB



FIELD LOGGED BY: TDC	COMPLETION DEPTH: 17.8m
PREPARED BY: MG	COMPLETION DATE: 2021-04-07
REVIEWED BY: TME	

CLIENT: CIMA+	PROJECT: TERWILLEGAR DRIVE UPGRADING STAGE 2	BOREHOLE NO: TH21-07
DRILLING COMPANY: ALL SERVICE DRILLING INC	DATE DRILLED: April 3 & 5, 2021	PROJECT NO: 30442
DRILL/METHOD: D50 Track / Solid Stem Augers - Coring	LOCATION: N5927802.106, E29610.803	ELEVATION: 631.17 (m)

SAMPLE TYPE	<input type="checkbox"/> GRAB SAMPLE	<input checked="" type="checkbox"/> SPT	<input type="checkbox"/> SHELBY TUBE	<input type="checkbox"/> CORE
BACKFILL TYPE	<input checked="" type="checkbox"/> BENTONITE	<input checked="" type="checkbox"/> DRILL CUTTINGS	<input type="checkbox"/> GROUT	

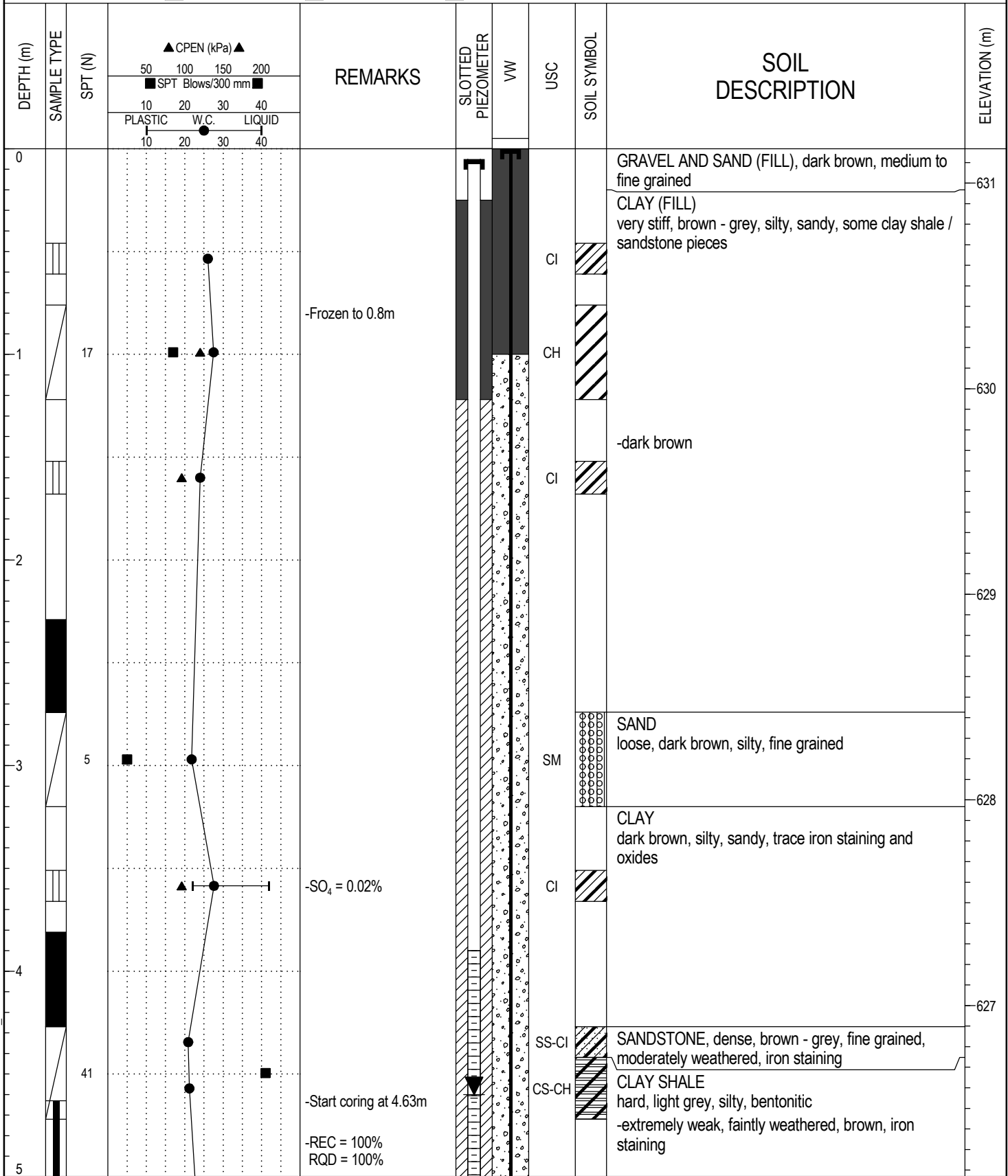

BOREHOLE LOG 30442-VW.GPJ_THRBR_AB.GDT_21-8-25_COPY OF LIBRARY-NEW LOGO-VW.GLB



FIELD LOGGED BY: TDC	COMPLETION DEPTH: 15.7 m
PREPARED BY: MG	COMPLETION DATE: 21-4-5
REVIEWED BY: TME	

CLIENT: CIMA+	PROJECT: TERWILLEGAR DRIVE UPGRADING STAGE 2	BOREHOLE NO: TH21-07
DRILLING COMPANY: ALL SERVICE DRILLING INC	DATE DRILLED: April 3 & 5, 2021	PROJECT NO: 30442
DRILL/METHOD: D50 Track / Solid Stem Augers - Coring	LOCATION: N5927802.106, E29610.803	ELEVATION: 631.17 (m)

SAMPLE TYPE	<input type="checkbox"/> GRAB SAMPLE	<input checked="" type="checkbox"/> SPT	<input type="checkbox"/> SHELBY TUBE	<input type="checkbox"/> CORE
BACKFILL TYPE	<input checked="" type="checkbox"/> BENTONITE	<input checked="" type="checkbox"/> DRILL CUTTINGS	<input type="checkbox"/> GROUT	

DEPTH (m)	SAMPLE TYPE	SPT (N)	CPEN (kPa)		REMARKS	SLOTTED PIEZOMETER	VW	USC	SOIL SYMBOL	SOIL DESCRIPTION	ELEVATION (m)
			50	100							
5					-Core breaks at 5.08m				CS-CH	-fresh, dark grey	626
					-Broken pieces at 5.32 - 5.37m					Siltstone, extremely weak, fresh, light brown, cemented	
					-Core breaks at 5.52 - 5.60m at 85 - 90° TCA						
					-REC = 93% RQD = 78%						
6		93/250			-Core break at 5.80m at 50° TCA, open, rough -Shoe break at 6.12m at 90° TCA				SI-CH	SANDSTONE, extremely weak, fresh, dark grey, fine grained, massive	625
										-dark bluish grey, bentonitic, thin bedding at 90° TCA, trace dark brown clay shale laminations	
7					-Core breaks at 6.91m & 6.93m at 80° & 90° TCA, open						624
					-REC = 83% RQD = 74%						
					-Core break at 7.53m at 80° TCA -Joints and broken pieces at 7.56 - 7.83m					CLAY SHALE extremely weak, fresh, dark brown - dark grey, silty	
8					-Core breaks at 8.10m, 8.21m, 8.38m, 8.86m at 90° TCA						623
					-Core break at 8.48m at 70° TCA, open, smooth					-light grey, fine grained bentonitic sandstone lenses at 8.34 - 8.38m	
					-REC = 97% RQD = 87%						
9					-Core break at 9.03m at 50° TCA, open, smooth					-dark grey	622
					-Joints at 9.29 - 9.35m at 25° TCA, open, rough -Shoe break at 9.45m at 90° TCA -Broken pieces at 9.60 - 10.40m						
10											

BOREHOLE LOG 30442-VW.GPJ_THRBR_AB.GDT_21-8-25_COPY OF LIBRARY-NEW LOGO-VW.GLB



FIELD LOGGED BY: TDC	COMPLETION DEPTH: 15.7 m
PREPARED BY: MG	COMPLETION DATE: 21-4-5
REVIEWED BY: TME	

CLIENT: CIMA+	PROJECT: TERWILLEGAR DRIVE UPGRADING STAGE 2	BOREHOLE NO: TH21-07
DRILLING COMPANY: ALL SERVICE DRILLING INC	DATE DRILLED: April 3 & 5, 2021	PROJECT NO: 30442
DRILL/METHOD: D50 Track / Solid Stem Augers - Coring	LOCATION: N5927802.106, E29610.803	ELEVATION: 631.17 (m)

SAMPLE TYPE	<input type="checkbox"/> GRAB SAMPLE	<input checked="" type="checkbox"/> SPT	<input type="checkbox"/> SHELBY TUBE	<input type="checkbox"/> CORE
BACKFILL TYPE	<input checked="" type="checkbox"/> BENTONITE	<input checked="" type="checkbox"/> DRILL CUTTINGS	<input type="checkbox"/> GROUT	

DEPTH (m)	SAMPLE TYPE	SPT (N)	CPEN (kPa)		REMARKS	SLOTTED PIEZOMETER	VW	USC	SOIL SYMBOL	SOIL DESCRIPTION	ELEVATION (m)
			50	100							
10					-REC = 52% RQD = 0%					NO RECOVERY	621
11					-Core break at 10.88m at 90° TCA, open, smooth -Joint at 11.05m at 80° TCA, open, stepped -Broken pieces at 11.13 - 11.22m -Joint at 11.38m at 70° TCA, open, stepped -Core break at 11.57m at 90° TCA, open, spun, smooth					CLAY SHALE very weak, fresh, dark grey, silty, massive	620
12					-REC = 95% RQD = 89% -Core break at 11.93m at 55° TCA, open, smooth					-dark grey - grey, thin bedding at 90° TCA	619
13					-Core break at 13.30m at 90° TCA -REC = 97% RQD = 97% -Core break at 13.63m at 90° TCA, open, rough					Sandstone, very weak, fresh, dark grey, fine grained, cemented -bedding at 85 - 90° TCA, trace brown cemented siltstone lenses	618
14					-Shoe breaks at 14.06 - 14.08m -Broken pieces at 14.17 - 14.54m					-dark brown, some dark brown cemented siltstone inclusions	617
15					-REC = 92%					SILTSTONE, very weak, fresh, light grey - dark brown, thin bedding	

BOREHOLE LOG 30442-VW.GPJ_THRBR_AB.GDT_21-8-25_COPY OF LIBRARY-NEW LOGO-VW.GLB



FIELD LOGGED BY: TDC	COMPLETION DEPTH: 15.7 m
PREPARED BY: MG	COMPLETION DATE: 21-4-5
REVIEWED BY: TME	

CLIENT: CIMA+		PROJECT: TERWILLEGAR DRIVE UPGRADING STAGE 2			BOREHOLE NO: TH21-07						
DRILLING COMPANY: ALL SERVICE DRILLING INC		DATE DRILLED: April 3 & 5, 2021			PROJECT NO: 30442						
DRILL/METHOD: D50 Track / Solid Stem Augers - Coring		LOCATION: N5927802.106, E29610.803			ELEVATION: 631.17 (m)						
SAMPLE TYPE		<input type="checkbox"/> GRAB SAMPLE	<input checked="" type="checkbox"/> SPT	<input type="checkbox"/> SHELBY TUBE	<input type="checkbox"/> CORE						
BACKFILL TYPE		<input type="checkbox"/> BENTONITE	<input checked="" type="checkbox"/> DRILL CUTTINGS	<input type="checkbox"/> GROUT							
DEPTH (m)	SAMPLE TYPE	SPT (N)	REMARKS			SLOTTED PIEZOMETER	VW	USC	SOIL SYMBOL	SOIL DESCRIPTION	ELEVATION (m)
			▲ CPEN (kPa) ▲	■ SPT Blows/300 mm ■	PLASTIC						
15			RQD = 72%						SANDSTONE, weak, fresh, light grey, fine grained, cemented	616	
			-Core break at 15.20m at 90° TCA, spun, smooth						CLAY SHALE very weak, fresh, dark grey, silty, thin bedding at 90° TCA, trace coal chips		
			-Core break at 15.50m at 90° TCA, open, spun, smooth						END OF TEST HOLE AT 15.7m UPON COMPLETION: Standpipe piezometer and vibrating wire piezometer installed (S/N 130590) WATER LEVEL BELOW GROUND SURFACE: Standpipe piezometer: -April 3, 2021 = Dry -May 10, 2021 = 4.4m -July 2, 2021 = 4.6m	615	
16										614	
17										613	
18										612	
19											
20											
		FIELD LOGGED BY: TDC		COMPLETION DEPTH: 15.7 m							
		PREPARED BY: MG		COMPLETION DATE: 21-4-5							
		REVIEWED BY: TME									

BOREHOLE LOG 30442-VW.GPJ_THRBR_AB.GDT_21-8-25_COPY OF LIBRARY-NEW LOGO-VW.GLB



CLIENT: CIMA+ PROJECT: TERWILLEGAR DRIVE UPGRADING STAGE 2 BOREHOLE NO: TH21-08

DRILLING COMPANY: ALL SERVICE DRILLING INC DATE DRILLED: April 3, 2021 PROJECT NO: 30442

DRILL/METHOD: D50 Track / Solid Stem Augers LOCATION: N5927851.615, E29613.143 ELEVATION: 629.79 (m)

SAMPLE TYPE GRAB SAMPLE SHELBY TUBE SPT

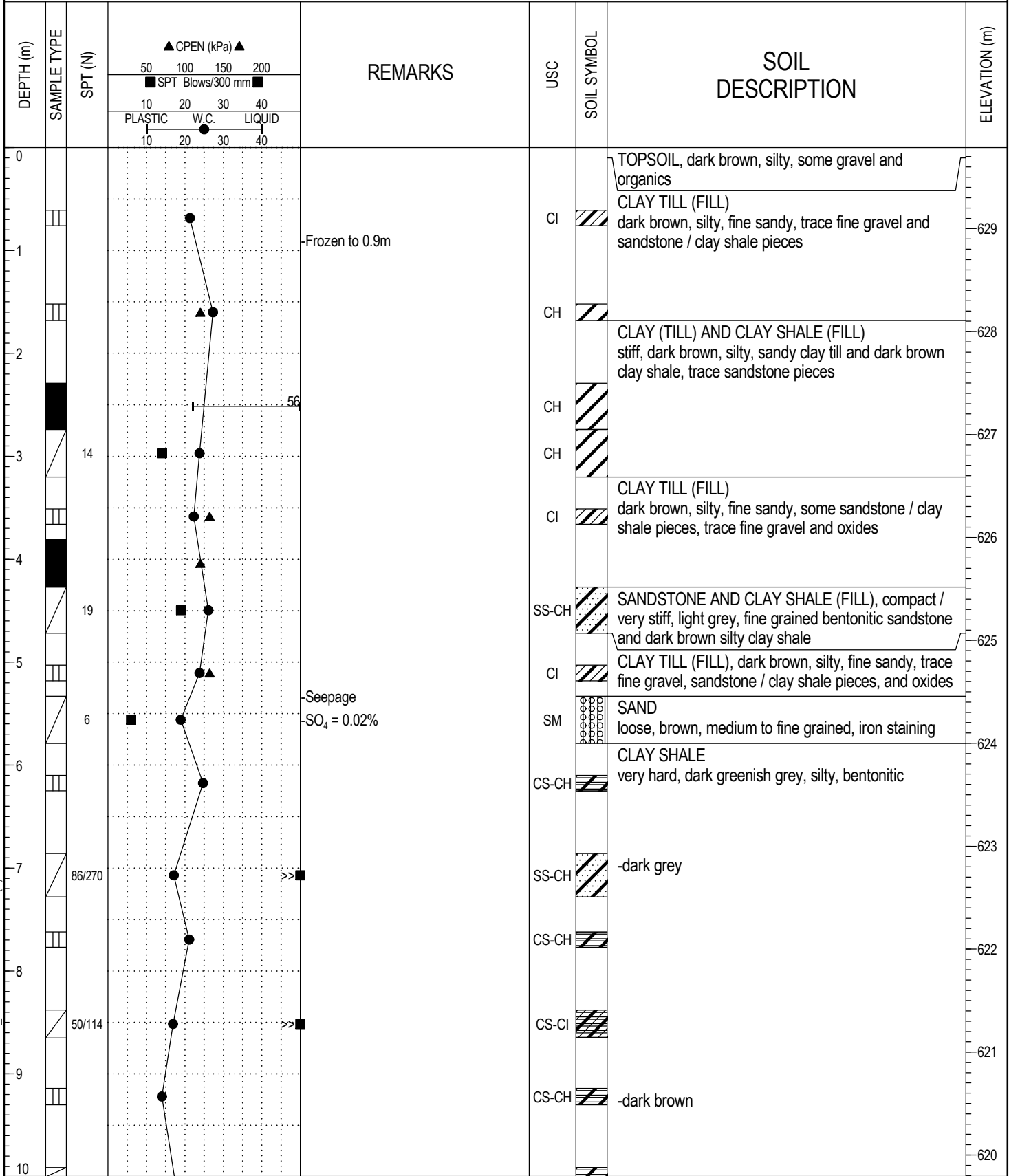

BOREHOLE LOG 30442-VW-GPJ_THRBR_AB_GDT_21-8-25_COPY (2) OF LIBRARY-NEW.LOGO.GLB



FIELD LOGGED BY: TDC	COMPLETION DEPTH: 14.5 m
PREPARED BY: MG	COMPLETION DATE: 2021-04-03
REVIEWED BY: TME	

CLIENT: CIMA+	PROJECT: TERWILLEGAR DRIVE UPGRADING STAGE 2	BOREHOLE NO: TH21-08
DRILLING COMPANY: ALL SERVICE DRILLING INC	DATE DRILLED: April 3, 2021	PROJECT NO: 30442
DRILL/METHOD: D50 Track / Solid Stem Augers	LOCATION: N5927851.615, E29613.143	ELEVATION: 629.79 (m)
SAMPLE TYPE <input type="checkbox"/> GRAB SAMPLE <input checked="" type="checkbox"/> SHELBY TUBE <input checked="" type="checkbox"/> SPT		

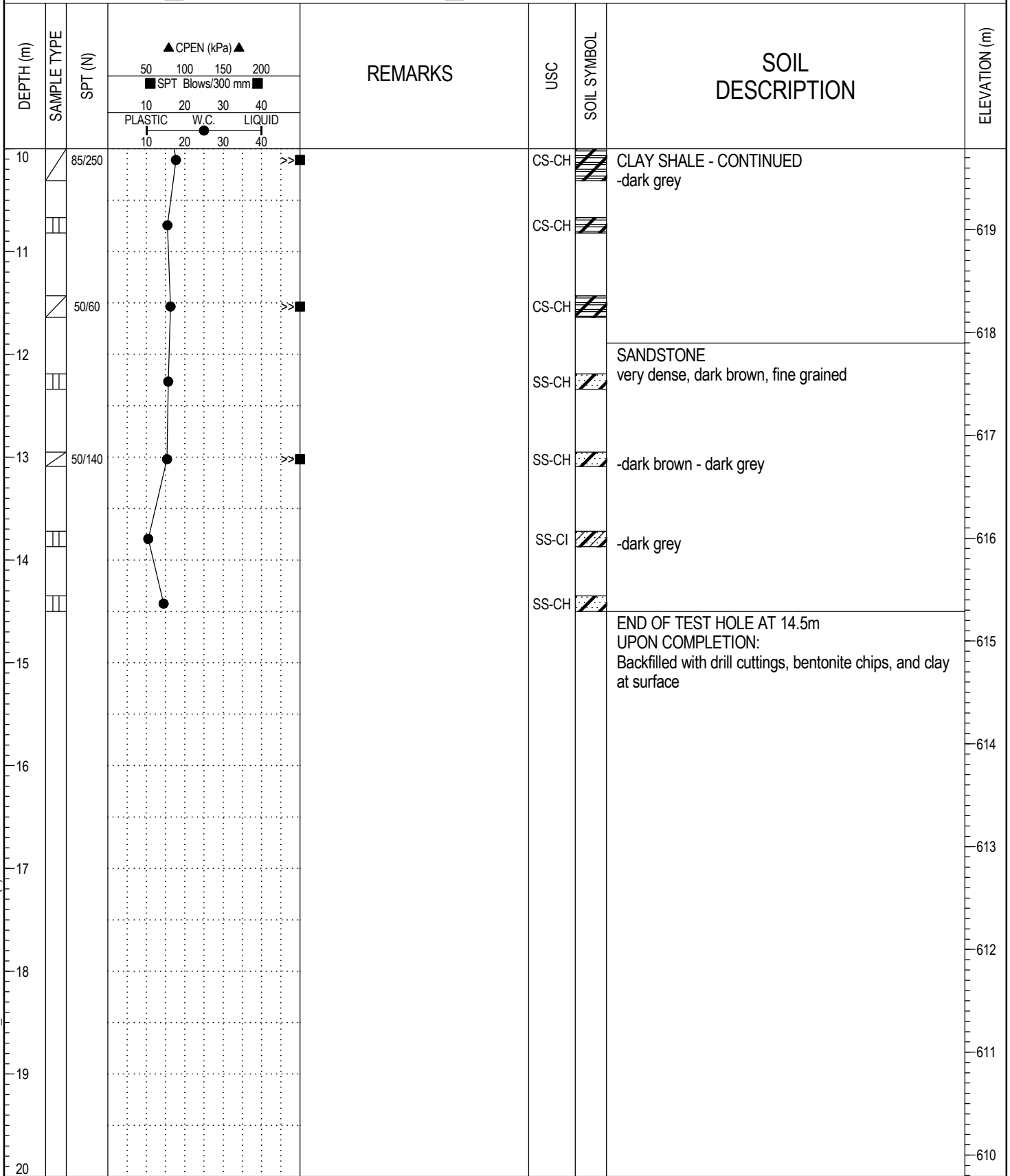

BOREHOLE LOG 30442-VW-GPJ_THRBR_AB.GDT_21-8-25_COPY (2) OF LIBRARY-NEW.LOGO.GLB



FIELD LOGGED BY: TDC	COMPLETION DEPTH: 14.5m
PREPARED BY: MG	COMPLETION DATE: 2021-04-03
REVIEWED BY: TME	

CLIENT: CIMA+	PROJECT: TERWILLEGAR DRIVE UPGRADING STAGE 2	BOREHOLE NO: TH21-09
DRILLING COMPANY: ALL SERVICE DRILLING INC	DATE DRILLED: April 9, 2021	PROJECT NO: 30442
DRILL/METHOD: D50 Track / Solid Stem Augers	LOCATION: N5927799.559, E29540.897	ELEVATION: 627.65 (m)
SAMPLE TYPE <input type="checkbox"/> GRAB SAMPLE <input checked="" type="checkbox"/> SPT <input checked="" type="checkbox"/> SHELBY TUBE		

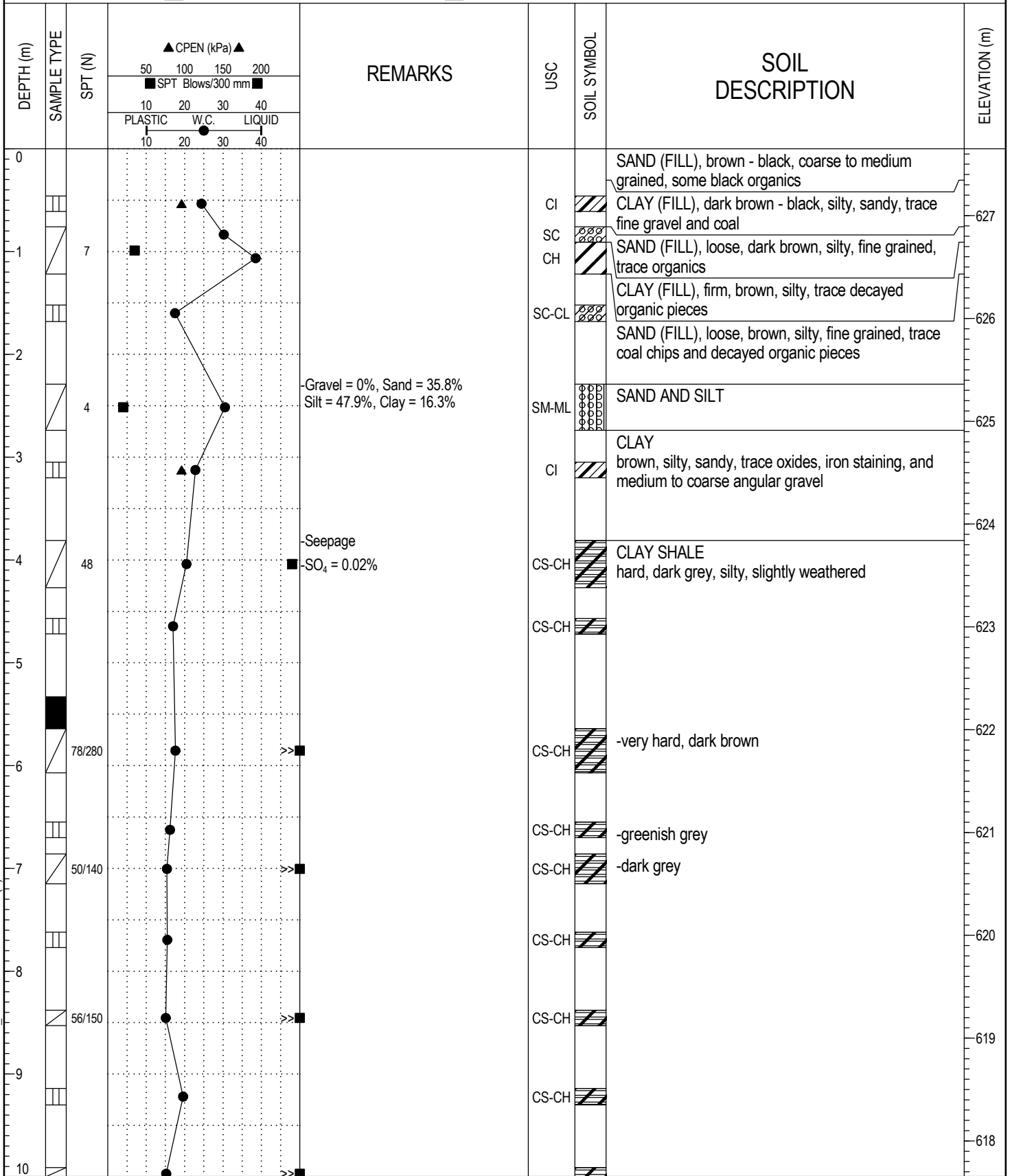

BOREHOLE LOG 30442-VW-GPJ_THRBR_AB.GDT_21-8-25_COPY (2) OF LIBRARY-NEW.LOGO.GLB



FIELD LOGGED BY: TDC	COMPLETION DEPTH: 14.6 m
PREPARED BY: MG	COMPLETION DATE: 2021-04-09
REVIEWED BY: TME	

CLIENT: CIMA+	PROJECT: TERWILLEGAR DRIVE UPGRADING STAGE 2	BOREHOLE NO: TH21-09
DRILLING COMPANY: ALL SERVICE DRILLING INC	DATE DRILLED: April 9, 2021	PROJECT NO: 30442
DRILL/METHOD: D50 Track / Solid Stem Augers	LOCATION: N5927799.559, E29540.897	ELEVATION: 627.65 (m)
SAMPLE TYPE <input type="checkbox"/> GRAB SAMPLE <input checked="" type="checkbox"/> SPT <input type="checkbox"/> SHELBY TUBE		

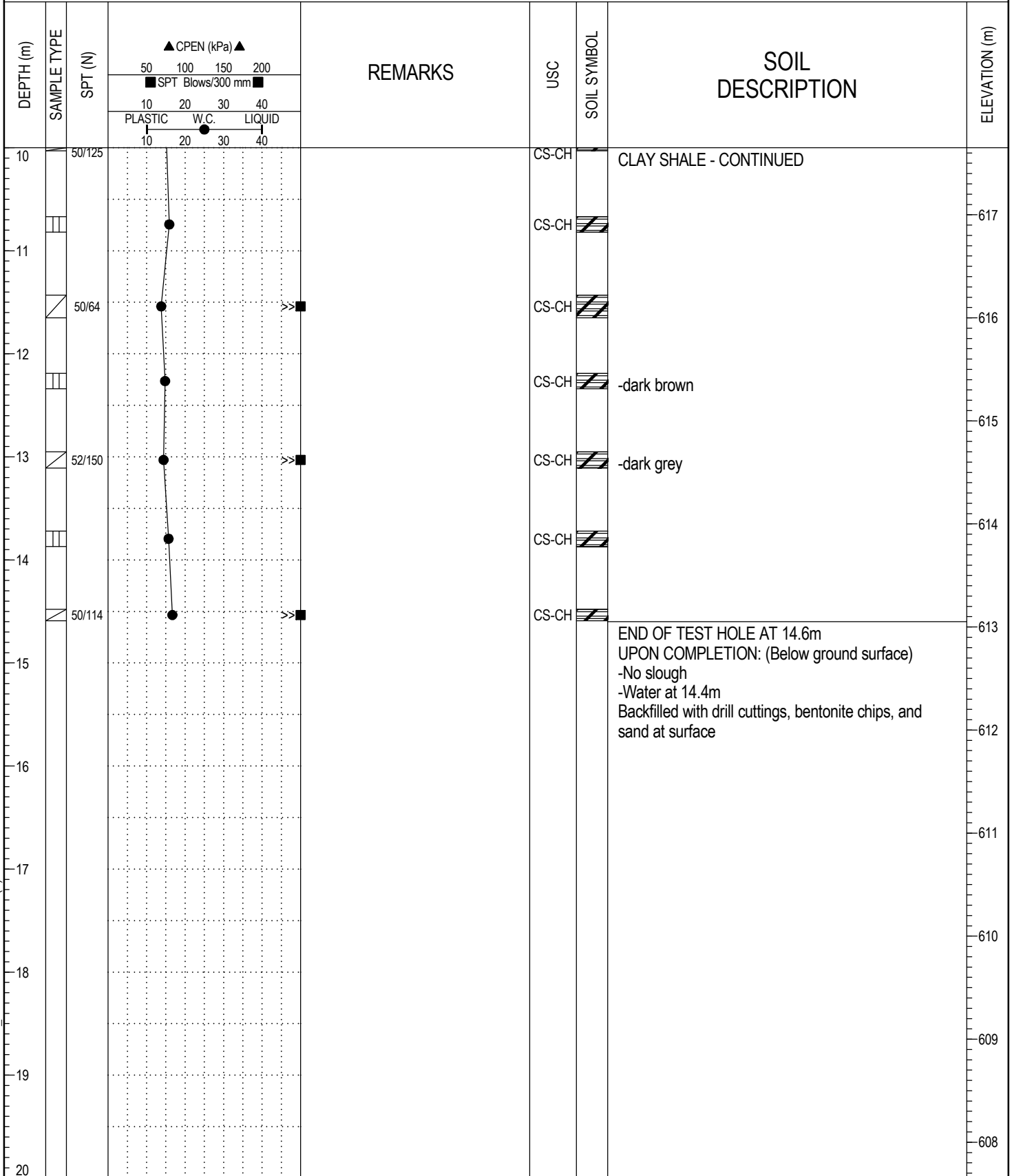

BOREHOLE LOG 30442-VW.GPJ_THRBR_AB.GDT_21-8-25_COPY (2) OF LIBRARY-NEW.LOGO.GLB



FIELD LOGGED BY: TDC	COMPLETION DEPTH: 14.6m
PREPARED BY: MG	COMPLETION DATE: 2021-04-09
REVIEWED BY: TME	

CLIENT: CIMA+	PROJECT: TERWILLEGAR DRIVE UPGRADING STAGE 2	BOREHOLE NO: TH21-10
DRILLING COMPANY: ALL SERVICE DRILLING INC	DATE DRILLED: April 8, 2021	PROJECT NO: 30442
DRILL/METHOD: D50 Track / Solid Stem Augers	LOCATION: N5927847.167, E29563.84	ELEVATION: 629.48 (m)

SAMPLE TYPE	<input type="checkbox"/> GRAB SAMPLE	<input checked="" type="checkbox"/> SPT	<input type="checkbox"/> SHELBY TUBE
BACKFILL TYPE	<input checked="" type="checkbox"/> BENTONITE	<input checked="" type="checkbox"/> DRILL CUTTINGS	

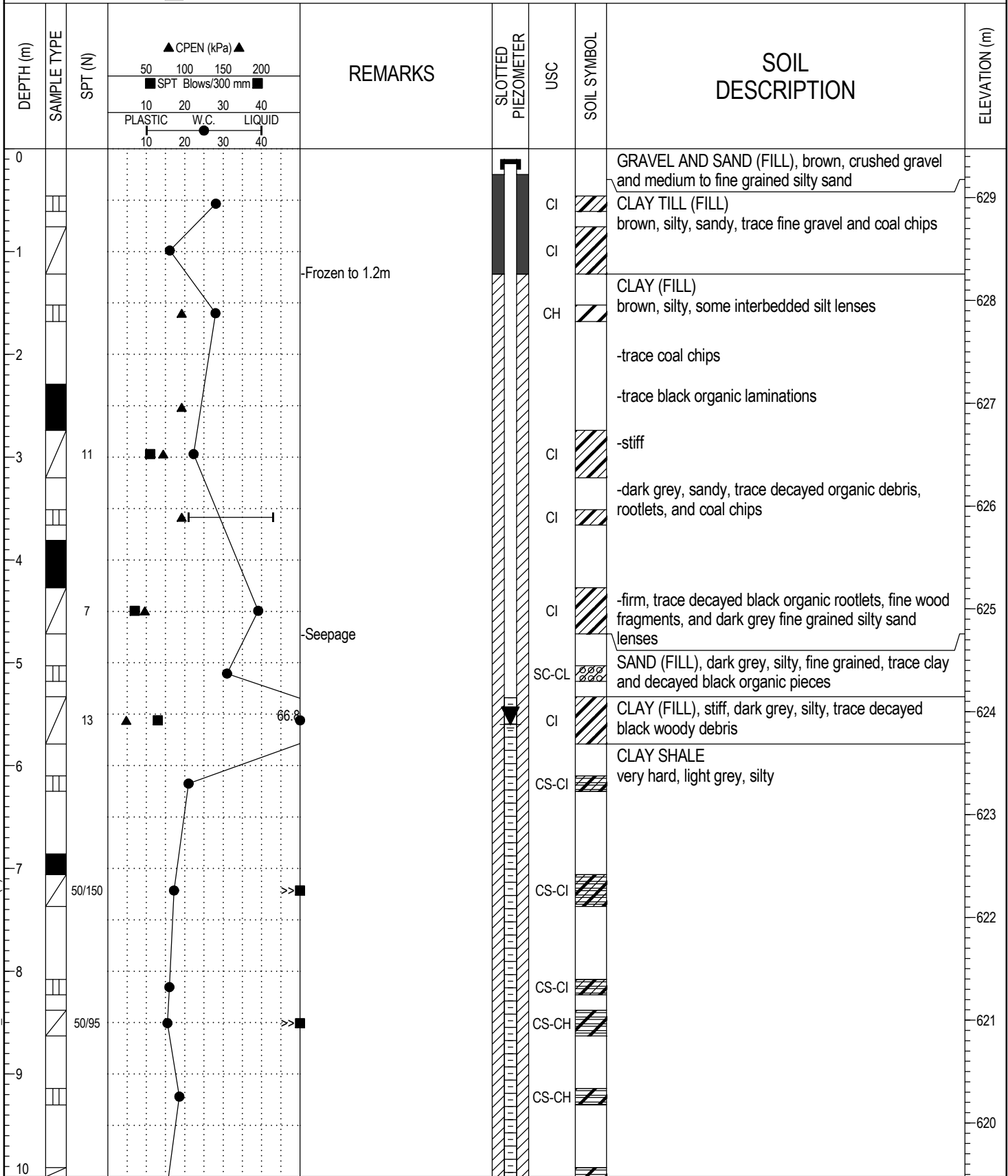

BOREHOLE LOG 30442-VW.GPJ_THRBR_AB.GDT_21-8-25_COPY (2) OF LIBRARY-NEW.LOGO.GLB



FIELD LOGGED BY: TDC	COMPLETION DEPTH: 14.6 m
PREPARED BY: MG	COMPLETION DATE: 2021-04-08
REVIEWED BY: TME	

CLIENT: CIMA+		PROJECT: TERWILLEGAR DRIVE UPGRADING STAGE 2		BOREHOLE NO: TH21-10						
DRILLING COMPANY: ALL SERVICE DRILLING INC		DATE DRILLED: April 8, 2021		PROJECT NO: 30442						
DRILL/METHOD: D50 Track / Solid Stem Augers		LOCATION: N5927847.167, E29563.84		ELEVATION: 629.48 (m)						
SAMPLE TYPE		<input type="checkbox"/> GRAB SAMPLE	<input checked="" type="checkbox"/> SPT	<input checked="" type="checkbox"/> SHELBY TUBE						
BACKFILL TYPE		<input checked="" type="checkbox"/> BENTONITE	<input checked="" type="checkbox"/> DRILL CUTTINGS							
DEPTH (m)	SAMPLE TYPE	SPT (N)	CPEN (kPa) ▲		REMARKS	SLOTTED PIEZOMETER	USC	SOIL SYMBOL	SOIL DESCRIPTION	ELEVATION (m)
			50	100						
			SPT Blows/300 mm ■							
			PLASTIC W.C. LIQUID							
			10	20	30	40				
10		50/90						CS-CH	CLAY SHALE - CONTINUED	619
11								CS-CH		
12		50/150						CS-CH	-dark grey, trace coal chips	618
								SS-CH	SANDSTONE, very dense, grey - brown, fine grained, trace coal chips	617
13		50/100						SS-CH		
								CS-CH	CLAY SHALE	616
14								CS-CH	very hard, dark brown, silty	
15		50/125						CS-CH		615
16									END OF TEST HOLE AT 14.6m UPON COMPLETION: (Below ground surface) -No slough -Water at 13.4m Standpipe piezometer installed WATER LEVEL BELOW GROUND SURFACE: -April 8, 2021 = 9.6m -May 10, 2021 = 5.6m -July 2, 2021 = 5.6m	614
17										613
18										612
19										611
20										610
					FIELD LOGGED BY: TDC		COMPLETION DEPTH: 14.6 m			
					PREPARED BY: MG		COMPLETION DATE: 2021-04-08			
					REVIEWED BY: TME		Page 2 of 2			

BOREHOLE LOG 30442-VW-GPJ_THRBR_AB.GDT_21-8-25_COPY (2) OF LIBRARY-NEW.LOGO.GLB

CLIENT: CIMA+	PROJECT: TERWILLEGAR DRIVE UPGRADING STAGE 2	BOREHOLE NO: TH21-11
DRILLING COMPANY: ALL SERVICE DRILLING INC	DATE DRILLED: April 2, 2021	PROJECT NO: 30442
DRILL/METHOD: D50 Track / Solid Stem Augers	LOCATION: N5927799.945, E29500.633	ELEVATION: 630.18 (m)
SAMPLE TYPE <input type="checkbox"/> GRAB SAMPLE <input checked="" type="checkbox"/> SPT <input checked="" type="checkbox"/> SHELBY TUBE		

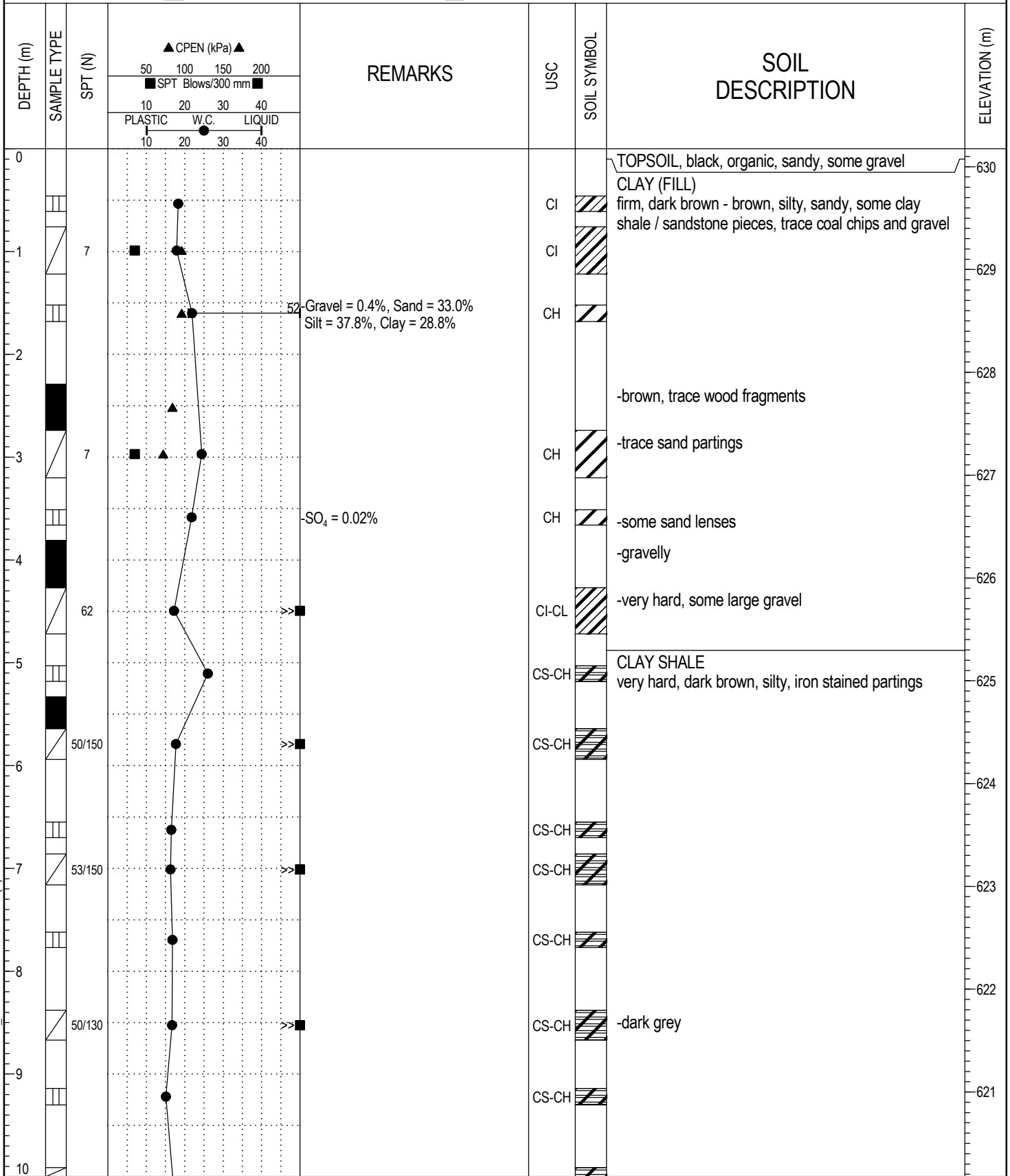

BOREHOLE LOG 30442-VW-GPJ_THRBR_AB_GDT_21-8-25_COPY (2) OF LIBRARY-NEW.LOGO.GLB



FIELD LOGGED BY: TDC	COMPLETION DEPTH: 14.7 m
PREPARED BY: MG	COMPLETION DATE: 2021-04-02
REVIEWED BY: TME	

CLIENT: CIMA+	PROJECT: TERWILLEGAR DRIVE UPGRADING STAGE 2	BOREHOLE NO: TH21-11
DRILLING COMPANY: ALL SERVICE DRILLING INC	DATE DRILLED: April 2, 2021	PROJECT NO: 30442
DRILL/METHOD: D50 Track / Solid Stem Augers	LOCATION: N5927799.945, E29500.633	ELEVATION: 630.18 (m)
SAMPLE TYPE <input type="checkbox"/> GRAB SAMPLE <input checked="" type="checkbox"/> SPT <input type="checkbox"/> SHELBY TUBE		

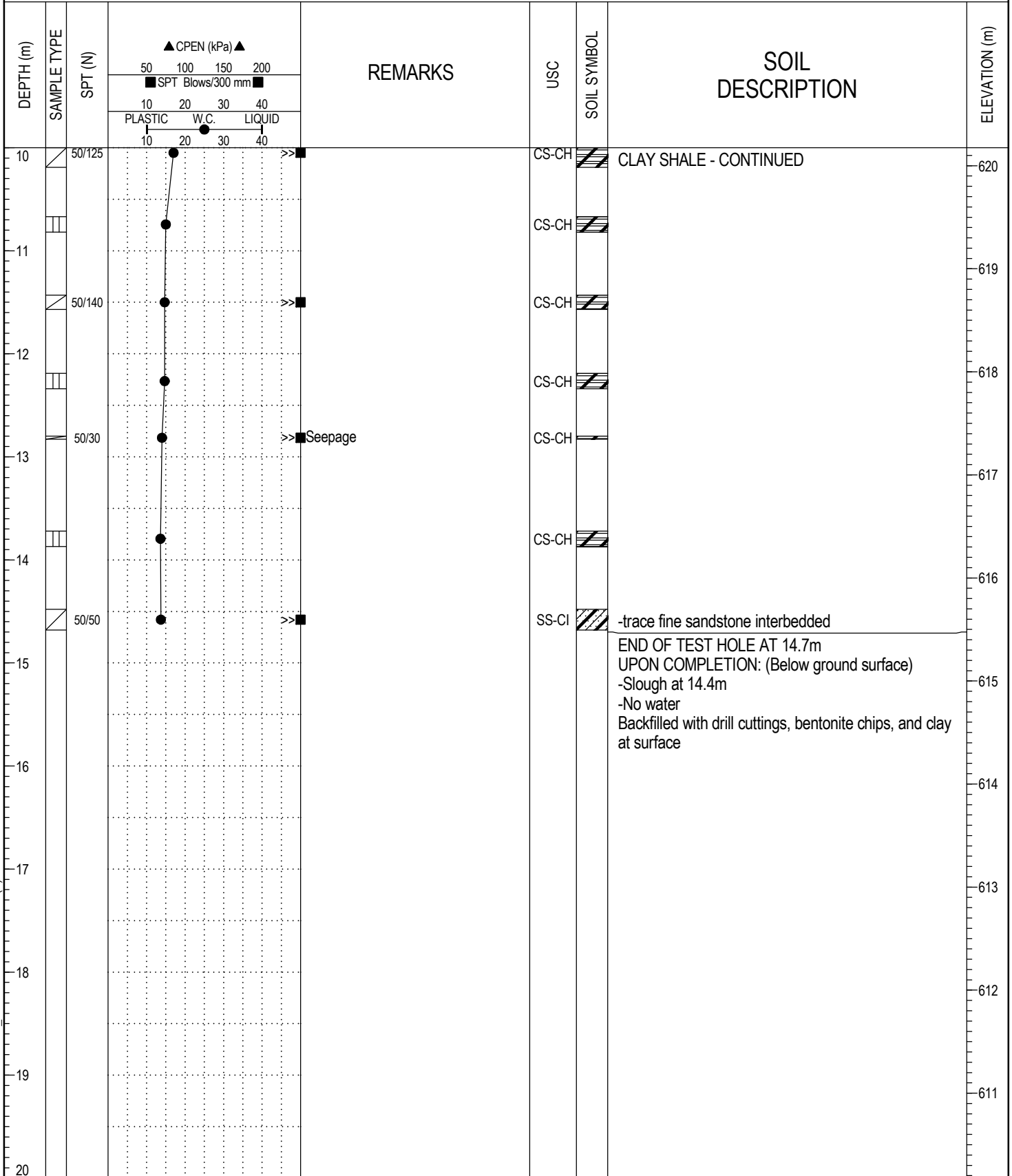

BOREHOLE LOG 30442-VW.GPJ_THRBR_AB.GDT_21-8-25_COPY (2) OF LIBRARY-NEW.LOGO.GLB



FIELD LOGGED BY: TDC	COMPLETION DEPTH: 14.7 m
PREPARED BY: MG	COMPLETION DATE: 2021-04-02
REVIEWED BY: TME	

CLIENT: CIMA+	PROJECT: TERWILLEGAR DRIVE UPGRADING STAGE 2	BOREHOLE NO: TH21-12
DRILLING COMPANY: ALL SERVICE DRILLING INC	DATE DRILLED: April 3 & 6, 2021	PROJECT NO: 30442
DRILL/METHOD: D50 Track / Solid Stem Augers - Coring	LOCATION: N5927846.324, E29491.486	ELEVATION: 633.49 (m)

SAMPLE TYPE	<input type="checkbox"/> GRAB SAMPLE	<input checked="" type="checkbox"/> SPT	<input checked="" type="checkbox"/> SHELBY TUBE	<input type="checkbox"/> CORE
BACKFILL TYPE	<input checked="" type="checkbox"/> BENTONITE	<input checked="" type="checkbox"/> DRILL CUTTINGS	<input type="checkbox"/> GROUT	

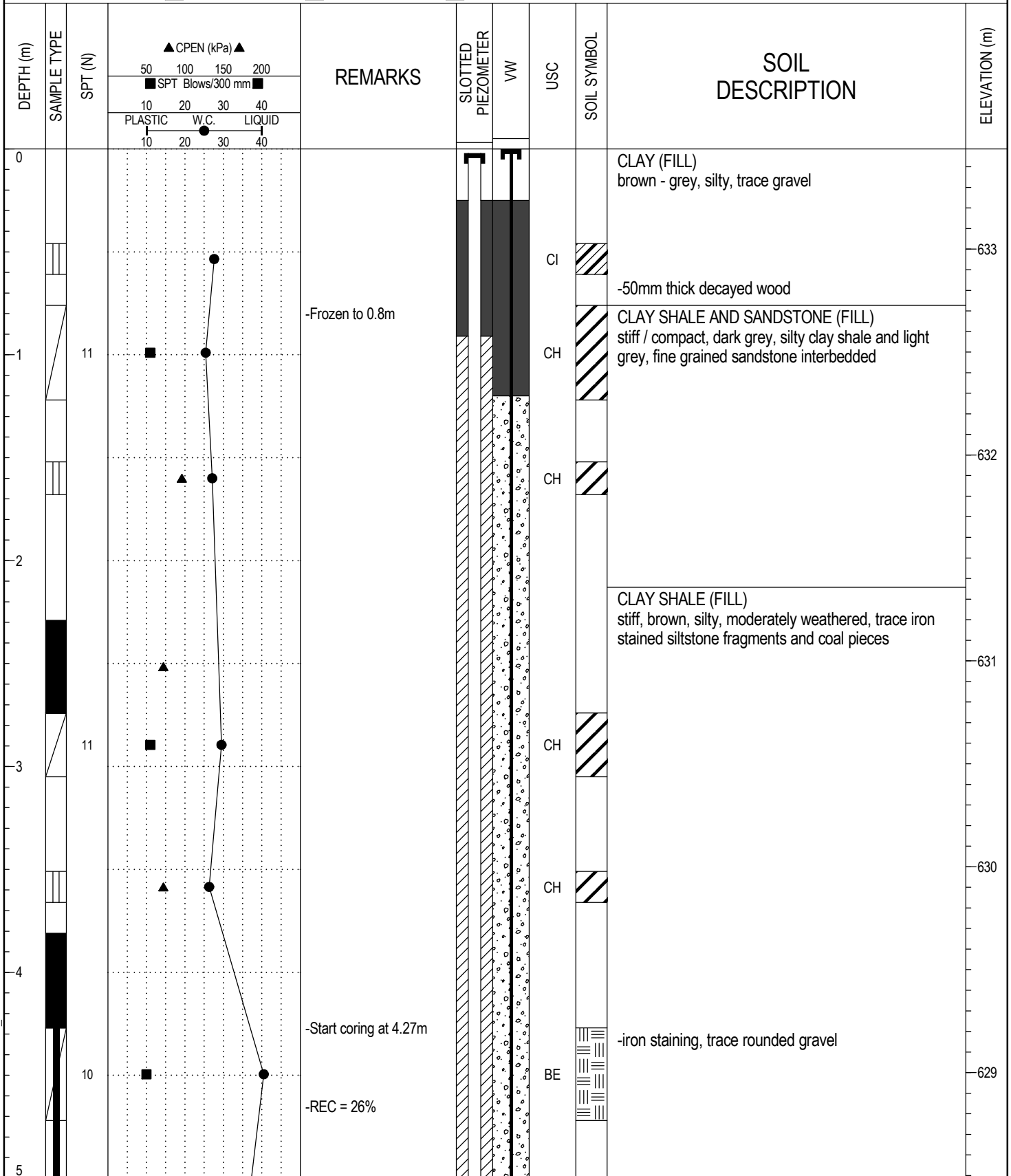

BOREHOLE LOG 30442-VW.GPJ_THRBR_AB.GDT_21-8-25_COPY OF LIBRARY-NEW LOGO-VW.GLB



FIELD LOGGED BY: TDC	COMPLETION DEPTH: 15.7 m
PREPARED BY: MG	COMPLETION DATE: 21-4-6
REVIEWED BY: TME	

CLIENT: CIMA+	PROJECT: TERWILLEGAR DRIVE UPGRADING STAGE 2	BOREHOLE NO: TH21-12
DRILLING COMPANY: ALL SERVICE DRILLING INC	DATE DRILLED: April 3 & 6, 2021	PROJECT NO: 30442
DRILL/METHOD: D50 Track / Solid Stem Augers - Coring	LOCATION: N5927846.324, E29491.486	ELEVATION: 633.49 (m)

SAMPLE TYPE	<input type="checkbox"/> GRAB SAMPLE	<input checked="" type="checkbox"/> SPT	<input type="checkbox"/> SHELBY TUBE	<input type="checkbox"/> CORE
BACKFILL TYPE	<input checked="" type="checkbox"/> BENTONITE	<input checked="" type="checkbox"/> DRILL CUTTINGS	<input type="checkbox"/> GROUT	

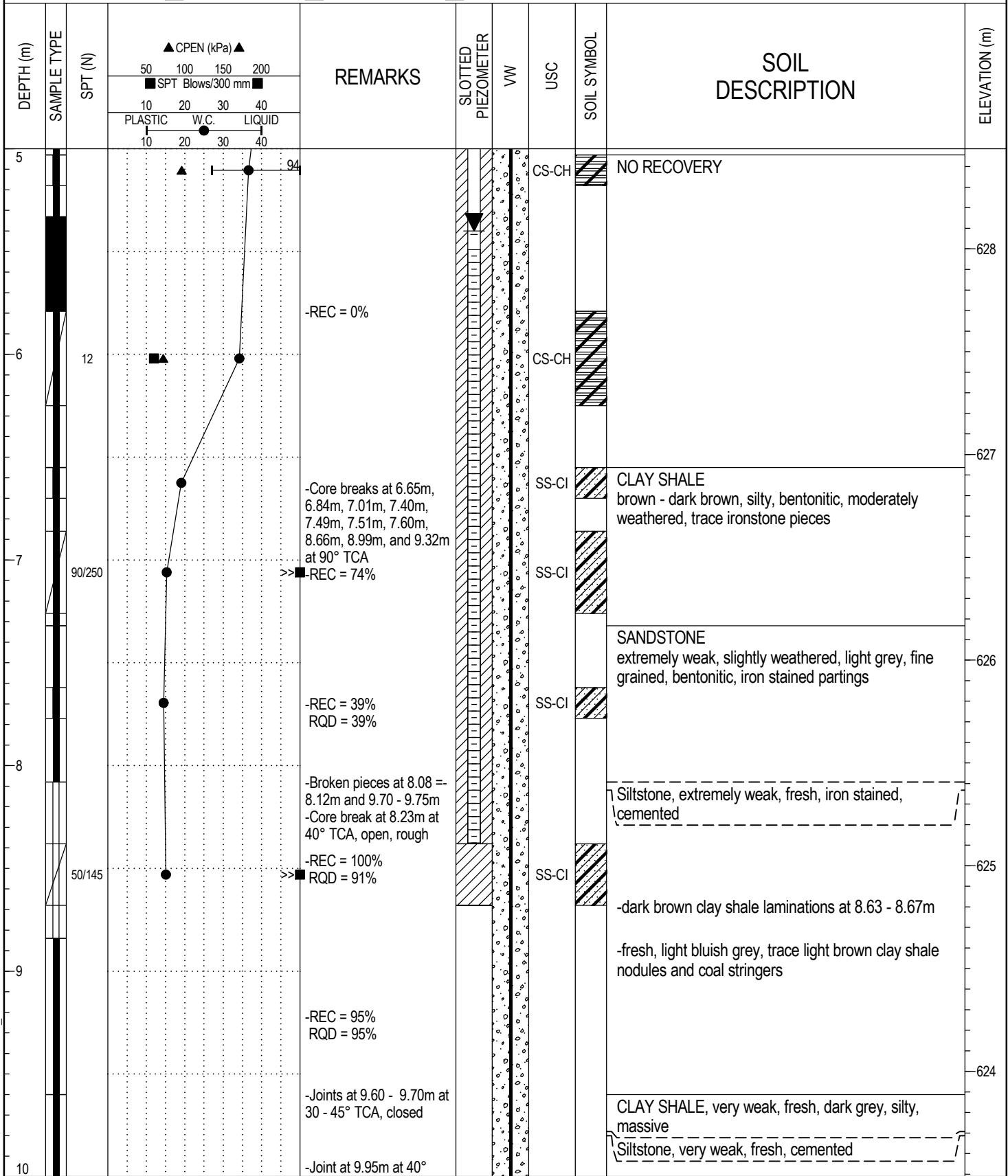

BOREHOLE LOG 30442-VW.GPJ_THRBR_AB.GDT_21-8-25_COPY OF LIBRARY-NEW LOGO-VW.GLB



FIELD LOGGED BY: TDC	COMPLETION DEPTH: 15.7 m
PREPARED BY: MG	COMPLETION DATE: 21-4-6
REVIEWED BY: TME	

CLIENT: CIMA+	PROJECT: TERWILLEGAR DRIVE UPGRADING STAGE 2	BOREHOLE NO: TH21-12
DRILLING COMPANY: ALL SERVICE DRILLING INC	DATE DRILLED: April 3 & 6, 2021	PROJECT NO: 30442
DRILL/METHOD: D50 Track / Solid Stem Augers - Coring	LOCATION: N5927846.324, E29491.486	ELEVATION: 633.49 (m)

SAMPLE TYPE	<input type="checkbox"/> GRAB SAMPLE	<input checked="" type="checkbox"/> SPT	<input type="checkbox"/> SHELBY TUBE	<input type="checkbox"/> CORE
BACKFILL TYPE	<input type="checkbox"/> BENTONITE	<input checked="" type="checkbox"/> DRILL CUTTINGS	<input type="checkbox"/> GROUT	

DEPTH (m)	SAMPLE TYPE	SPT (N)	CPEN (kPa) ▲		REMARKS	SLOTTED PIEZOMETER	VW	USC	SOIL SYMBOL	SOIL DESCRIPTION	ELEVATION (m)
			50	100							
10					TCA, open, smooth -Joints at 10.03 - 10.10m at 30 - 45° TCA, open -Core breaks at 10.20m, 10.38m, 10.48m, 10.52m, and 10.59m at 90° TCA, smooth -REC = 99% RQD = 80% -Core break at 10.68m at 90° TCA				-dark brown - dark grey	623	
11					-Joints at 10.85 - 11.13m at 30 - 45° TCA, closed -Joints at 11.13 - 11.34m and 11.50 - 11.57m at 15 - 45° TCA, open, smooth				-extremely weak, dark brown	622	
12					-Core break at 11.68m on coal stringers -Core breaks at 11.80 - 11.87m on coal stringers -REC = 100% RQD = 82%				-coal stringers -coal stringers at 11.80 - 11.87m -coal stringers	621	
13					-Shoe break at 12.63m at 90° TCA -Joints at 12.70 - 12.82m at 10° TCA, open, rough -Joints at 12.86 - 13.35m at 45 - 60° TCA, closed				SANDSTONE very weak, fresh, light bluish grey, fine grained, bentonitic, trace dark grey clay shale laminations	620	
14					-REC = 100% RQD = 93% -Core break at 13.54m at 90° TCA, open, smooth -Joints at 13.60 - 13.74m at 40 - 90° TCA, closed -Broken pieces at 13.93 - 14.00m				CLAY SHALE very weak, fresh, dark grey, silty, massive	619	
15					-Joint at 14.35m at 45° TCA, open, stepped -Joint at 14.47m at 40° TCA, open, rough -Joints at 14.55m and 14.63m at 90° TCA, open, rough -Joint at 14.81m at 85°				-light brown cemented siltstone inclusions at 13.70 - 13.74m		

BOREHOLE LOG 30442-VW.GPJ_THRBR_AB.GDT_21-8-25_COPY OF LIBRARY-NEW LOGO-VW.GLB



FIELD LOGGED BY: TDC	COMPLETION DEPTH: 15.7 m
PREPARED BY: MG	COMPLETION DATE: 21-4-6
REVIEWED BY: TME	

CLIENT: CIMA+	PROJECT: TERWILLEGAR DRIVE UPGRADING STAGE 2	BOREHOLE NO: TH21-12
DRILLING COMPANY: ALL SERVICE DRILLING INC	DATE DRILLED: April 3 & 6, 2021	PROJECT NO: 30442
DRILL/METHOD: D50 Track / Solid Stem Augers - Coring	LOCATION: N5927846.324, E29491.486	ELEVATION: 633.49 (m)

SAMPLE TYPE	<input type="checkbox"/> GRAB SAMPLE	<input checked="" type="checkbox"/> SPT	<input type="checkbox"/> SHELBY TUBE	<input type="checkbox"/> CORE
BACKFILL TYPE	<input checked="" type="checkbox"/> BENTONITE	<input checked="" type="checkbox"/> DRILL CUTTINGS	<input type="checkbox"/> GROUT	

DEPTH (m)	SAMPLE TYPE	SPT (N)	REMARKS			SLOTTED PIEZOMETER	VW	USC	SOIL SYMBOL	SOIL DESCRIPTION	ELEVATION (m)
			▲ CPEN (kPa) ▲ 50 100 150 200 ■ SPT Blows/300 mm ■ 10 20 30 40 PLASTIC W.C. LIQUID 10 20 30 40								
			15								
16								END OF TEST HOLE AT 15.7m UPON COMPLETION: Standpipe piezometer and vibrating wire piezometer installed (S/N 130592) WATER LEVEL BELOW GROUND SURFACE: Standpipe piezometer: -April 3, 2021 = Dry -May 10, 2021 = 4.4m -July 2, 2021 = 5.4m	617		
17										616	
18										615	
19										614	
20											

BOREHOLE LOG 30442-VW.GPJ_THRBR_AB.GDT_21-8-25_COPY OF LIBRARY-NEW LOGO-VW.GLB



FIELD LOGGED BY: TDC	COMPLETION DEPTH: 15.7 m
PREPARED BY: MG	COMPLETION DATE: 21-4-6
REVIEWED BY: TME	

CLIENT: CIMA+	PROJECT: TERWILLEGAR DRIVE UPGRADING STAGE 2	BOREHOLE NO: TH21-13
DRILLING COMPANY: ALL SERVICE DRILLING INC	DATE DRILLED: April 1, 2021	PROJECT NO: 30442
DRILL/METHOD: D50 Track / Solid Stem Augers	LOCATION: N5927797.716, E29439.742	ELEVATION: 648.04 (m)

SAMPLE TYPE	<input type="checkbox"/> GRAB SAMPLE	<input checked="" type="checkbox"/> SPT	<input type="checkbox"/> SHELBY TUBE
BACKFILL TYPE	<input checked="" type="checkbox"/> BENTONITE	<input checked="" type="checkbox"/> DRILL CUTTINGS	<input type="checkbox"/> SLOUGH

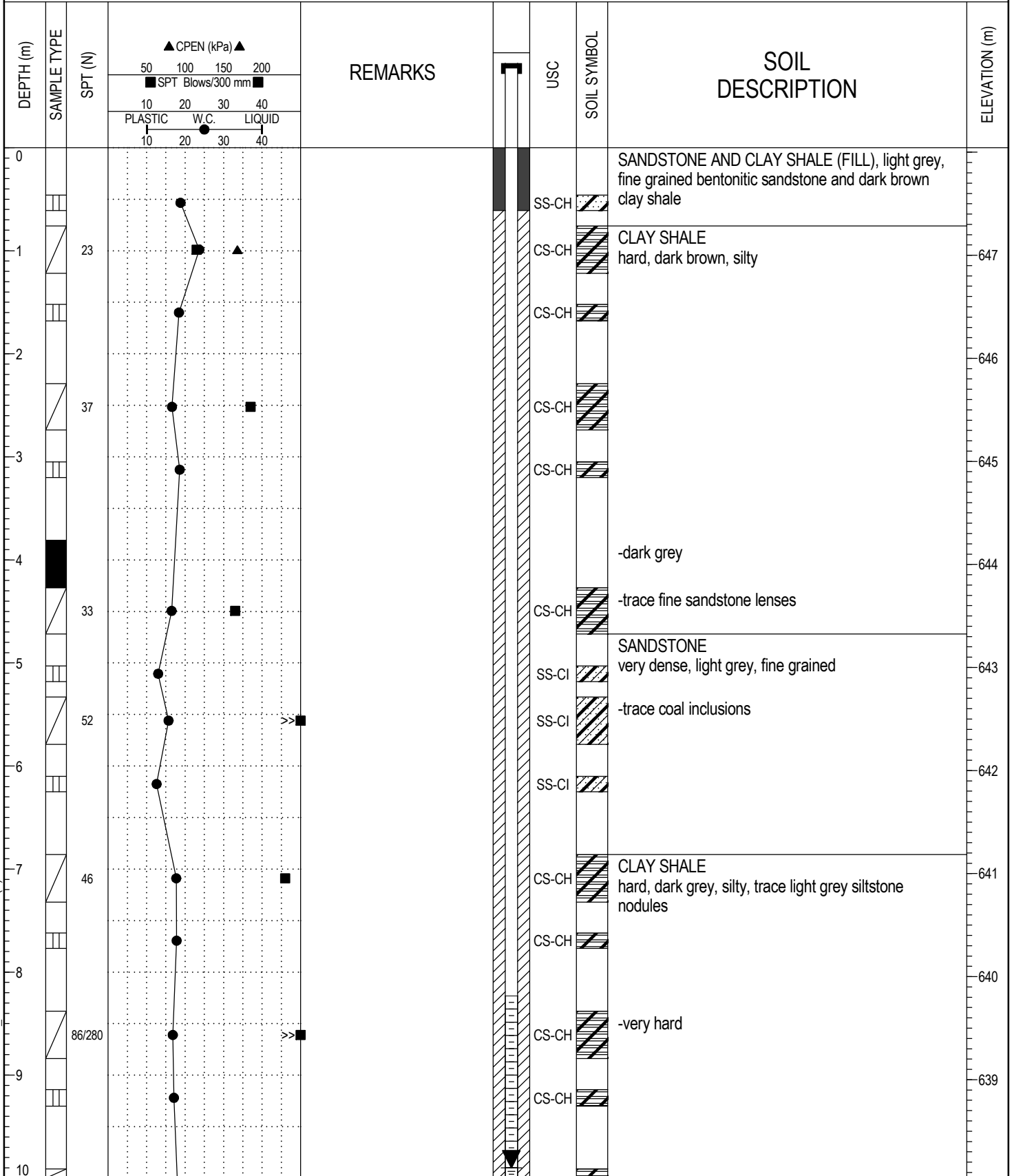

BOREHOLE LOG 30442-VW-GPJ_THRBR_AB_GDT_21-8-25_COPY (2) OF LIBRARY-NEW.LOG.GLB



FIELD LOGGED BY: TDC	COMPLETION DEPTH: 14.9 m
PREPARED BY: MG	COMPLETION DATE: 2021-04-01
REVIEWED BY: TME	

CLIENT: CIMA+	PROJECT: TERWILLEGAR DRIVE UPGRADING STAGE 2	BOREHOLE NO: TH21-13
DRILLING COMPANY: ALL SERVICE DRILLING INC	DATE DRILLED: April 1, 2021	PROJECT NO: 30442
DRILL/METHOD: D50 Track / Solid Stem Augers	LOCATION: N5927797.716, E29439.742	ELEVATION: 648.04 (m)

SAMPLE TYPE	<input type="checkbox"/> GRAB SAMPLE	<input checked="" type="checkbox"/> SPT	<input type="checkbox"/> SHELBY TUBE
BACKFILL TYPE	<input checked="" type="checkbox"/> BENTONITE	<input checked="" type="checkbox"/> DRILL CUTTINGS	<input type="checkbox"/> SLOUGH

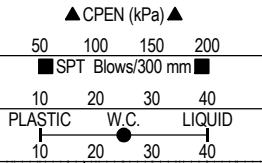
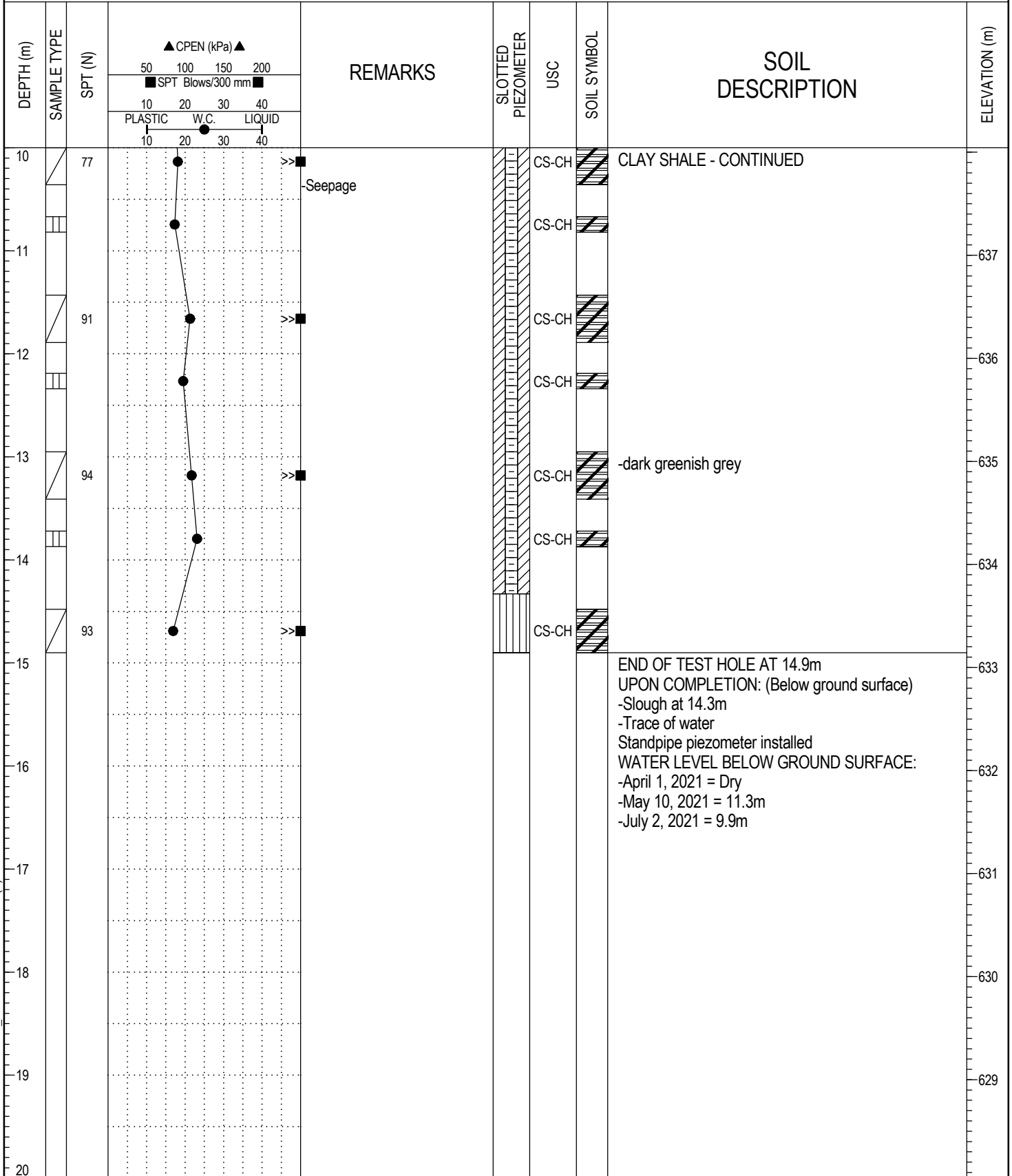

BOREHOLE LOG 30442-VW.GPJ_THRBR_AB.GDT_21-8-25_COPY (2) OF LIBRARY-NEW.LOGO.GLB



FIELD LOGGED BY: TDC	COMPLETION DEPTH: 14.9m
PREPARED BY: MG	COMPLETION DATE: 2021-04-01
REVIEWED BY: TME	

CLIENT: CIMA+	PROJECT: TERWILLEGAR DRIVE UPGRADING STAGE 2	BOREHOLE NO: TH21-14
DRILLING COMPANY: ALL SERVICE DRILLING INC	DATE DRILLED: April 2, 2021	PROJECT NO: 30442
DRILL/METHOD: D50 Track / Solid Stem Augers	LOCATION: N5927838.94, E29424.816	ELEVATION: 648.30 (m)
SAMPLE TYPE <input type="checkbox"/> GRAB SAMPLE <input checked="" type="checkbox"/> SPT		

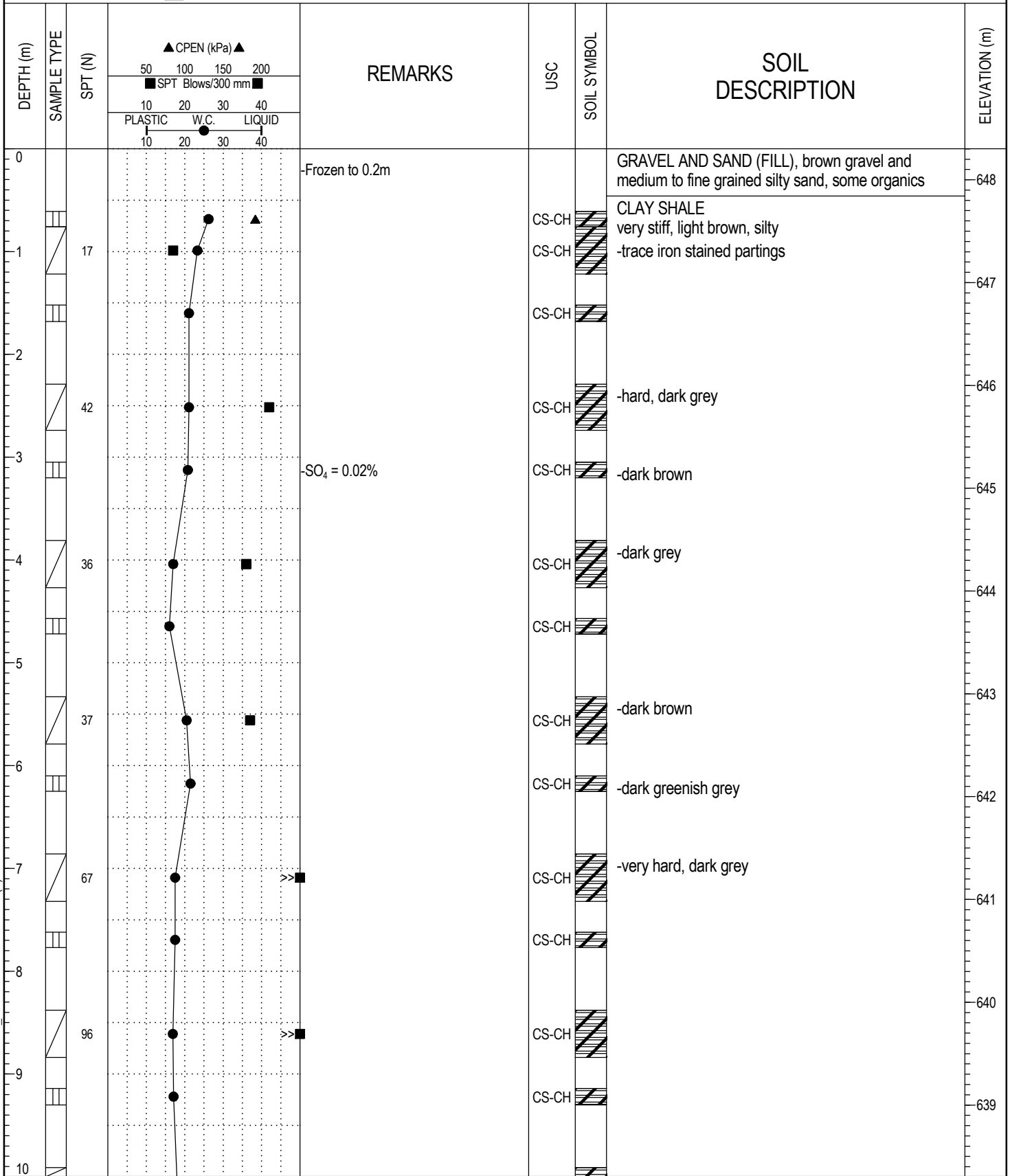

BOREHOLE LOG 30442-VW-GPJ_THRBR_AB.GDT_21-8-25_COPY (2) OF LIBRARY-NEW.LOGO.GLB



FIELD LOGGED BY: TDC	COMPLETION DEPTH: 14.7 m
PREPARED BY: MG	COMPLETION DATE: 2021-04-02
REVIEWED BY: TME	

CLIENT: CIMA+	PROJECT: TERWILLEGAR DRIVE UPGRADING STAGE 2	BOREHOLE NO: TH21-14
DRILLING COMPANY: ALL SERVICE DRILLING INC	DATE DRILLED: April 2, 2021	PROJECT NO: 30442
DRILL/METHOD: D50 Track / Solid Stem Augers	LOCATION: N5927838.94, E29424.816	ELEVATION: 648.30 (m)

SAMPLE TYPE GRAB SAMPLE SPT

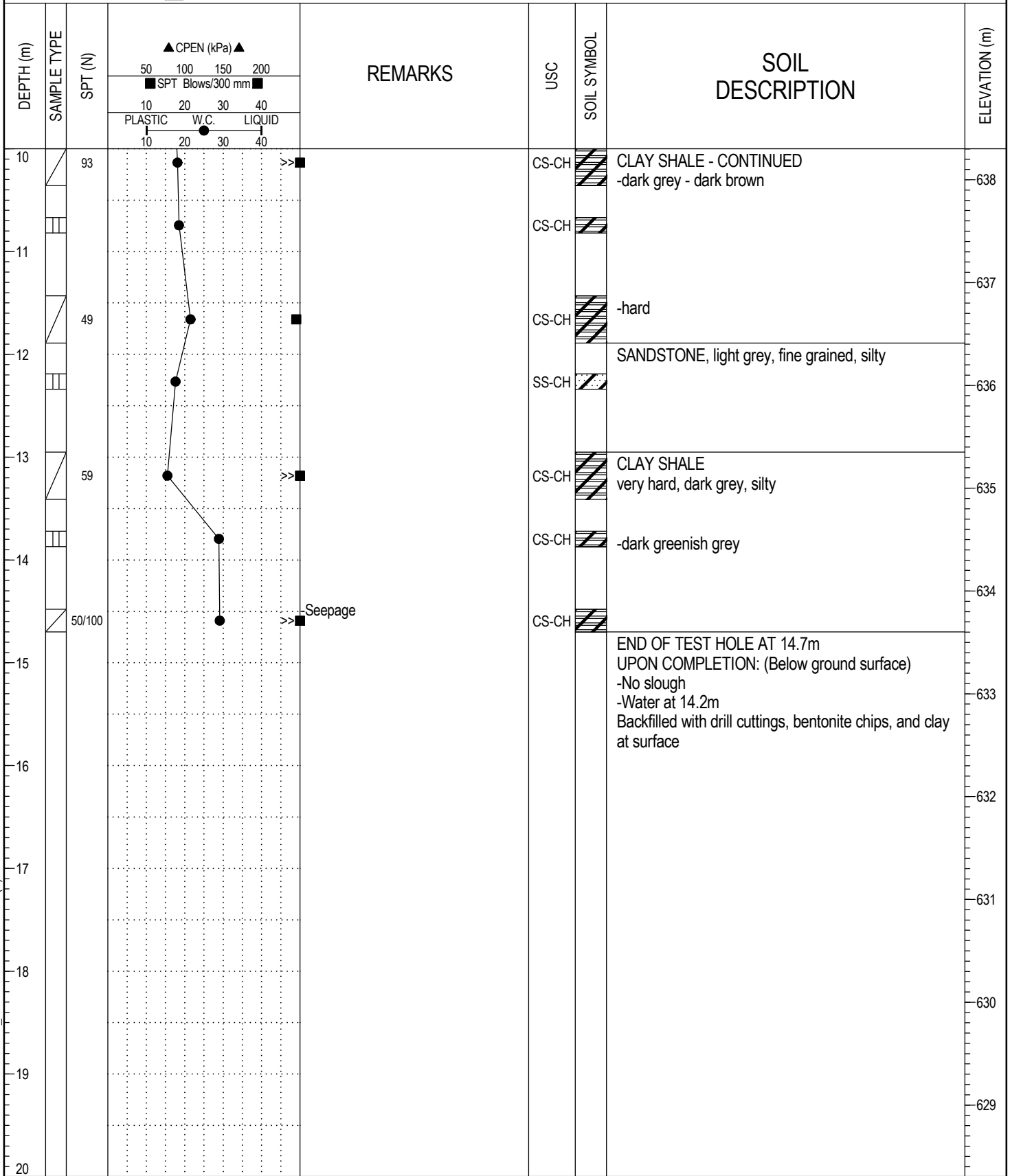

BOREHOLE LOG 30442-VW-GPJ_THRBR_AB.GDT_21-8-25_COPY (2) OF LIBRARY-NEW.LOGO.GLB



FIELD LOGGED BY: TDC	COMPLETION DEPTH: 14.7 m
PREPARED BY: MG	COMPLETION DATE: 2021-04-02
REVIEWED BY: TME	



APPENDIX C

Laboratory Test Results



ATTERBERG LIMITS ASTM D4318

Client: CIMA+
Project: Terwillegar Drive Stage 2 - Preliminary Design and Delivery

THURBER Project No: 30442
Test Hole: TH21-2
Sample No: P5
Depth: 2.74 - 3.20 m

Date Tested: 16-Sep-21
Tested By: LLK
Checked By:

LIQUID LIMIT

Trial No:	1	2	3	4
No of Blows:	38	32	23	17
Container No.	1	2	3	4
Wet Soil + Container	14.89	15.11	12.53	15.17
Dry Soil + Container	8.15	8.22	6.73	8.06
Wt. Of Container	0	0	0	0
Moisture Content	82.7	83.8	86.2	88.2

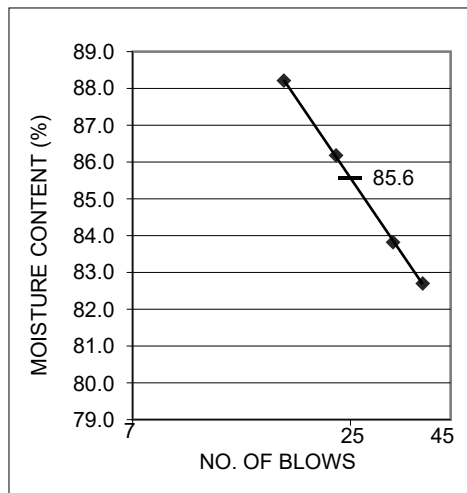

PLASTIC LIMIT

	1	2	AVERAGE
Container No.	5	6	
Wet Soil + Container	29.41	29.06	
Dry Soil + Container	26.94	26.73	
Wt. Of Container	18.7	18.93	
Moisture Content	30.0	29.9	29.9

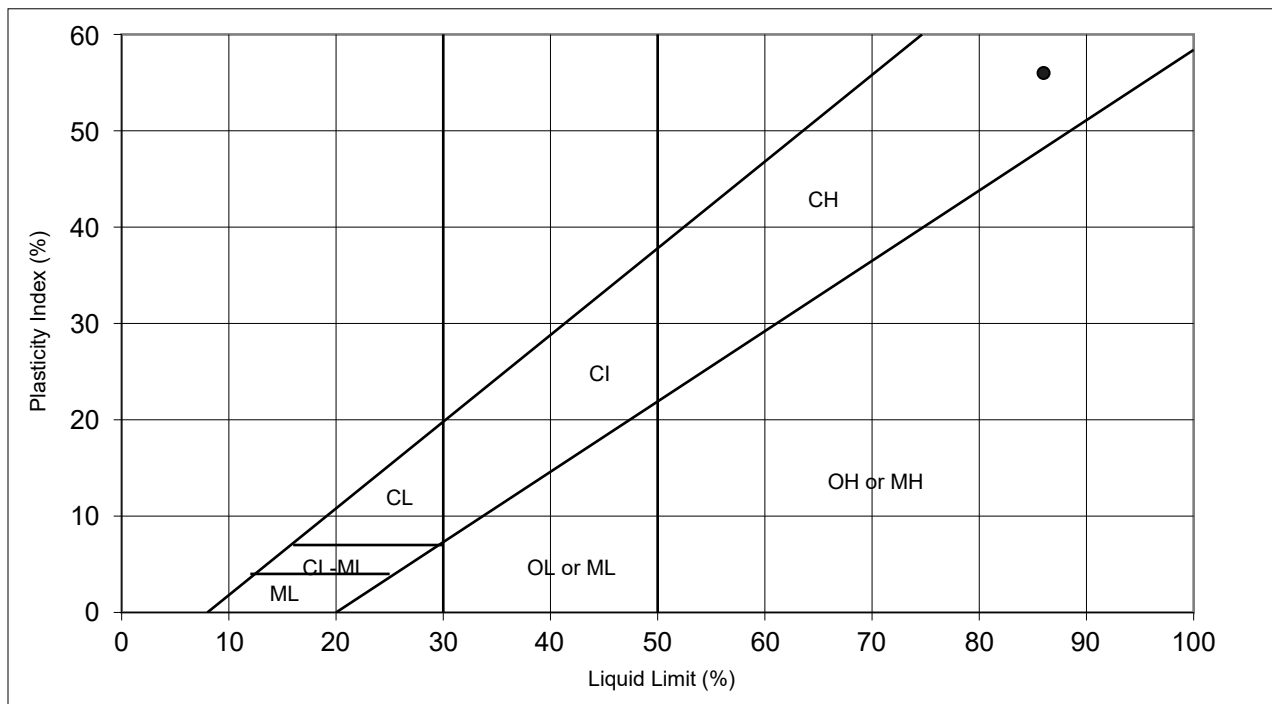

REMARKS

Liquid Limit:	86
Plastic Limit:	30
Plasticity Index:	56
USC Classification:	CH



ATTERBERG LIMITS
ASTM D4318

Client: CIMA+ Canada Inc
Project: Terwillegar Drive Stage 2
Project No: 30442
Test Hole: TH21-5
Sample No: ST9
Depth: 5.33 - 5.79 m

Date Tested: 12-Apr-21
Tested By: JAP
Checked By:

LIQUID LIMIT

Trial No:	1	2	3	4
No of Blows:	42	34	27	18
Container No.	1	2	3	4
Wet Soil + Container	17.27	16.86	16.04	16.12
Dry Soil + Container	10.93	10.62	10.05	10
Wt. Of Container	0	0	0	0
Moisture Content	58.0	58.8	59.6	61.2

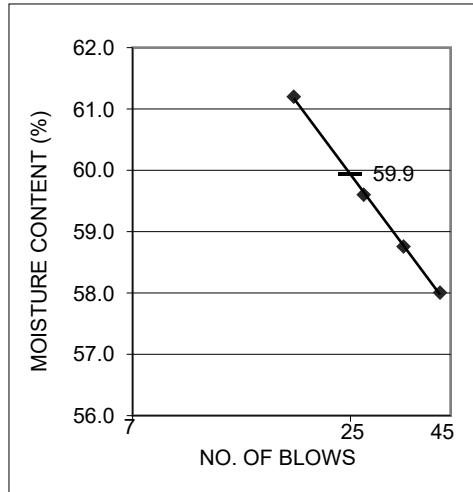

PLASTIC LIMIT

	1	2	AVERAGE
Container No.	5	6	
Wet Soil + Container	27.96	27.89	
Dry Soil + Container	25.95	25.93	
Wt. Of Container	18.75	18.87	
Moisture Content	27.9	27.8	27.8

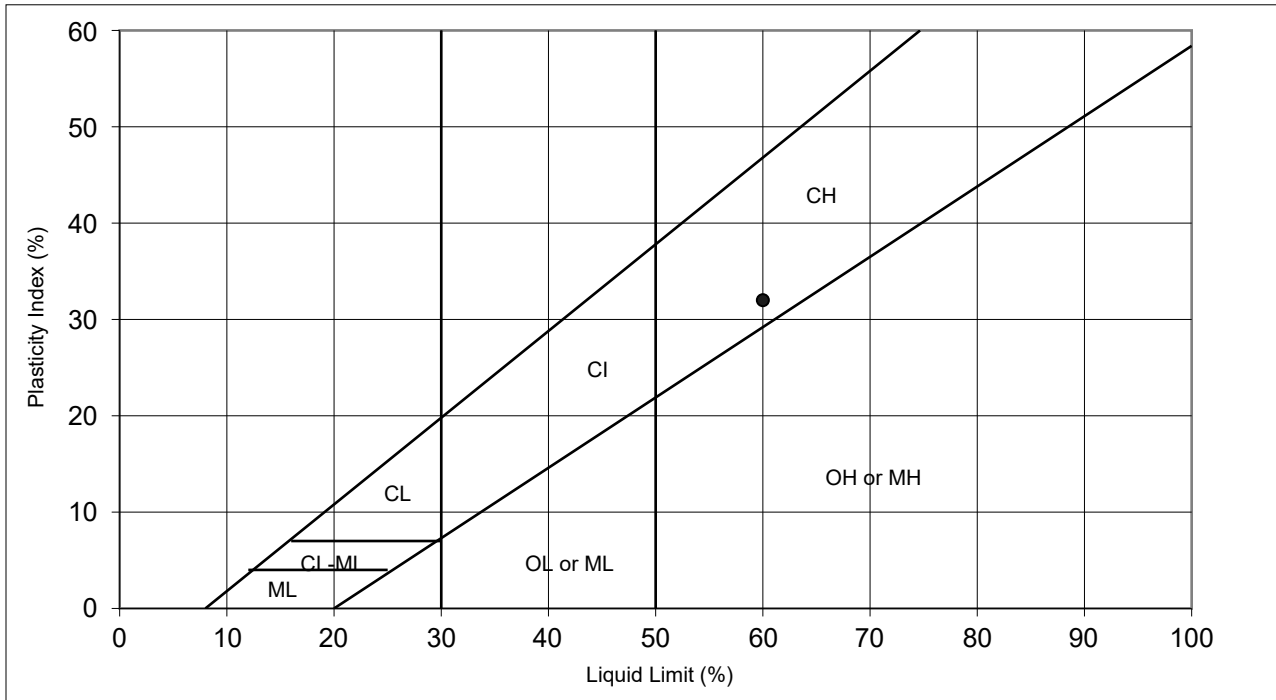

REMARKS

Liquid Limit:	60
Plastic Limit:	28
Plasticity Index:	32
USC Classification:	CH



ATTERBERG LIMITS
ASTM D4318

Client: CIMA+ Canada Inc
Project: Terwillegar Drive Stage 2
Project No: 30442
Test Hole: TH21-5
Sample No: ST14
Depth: 8.38 - 8.84 m

Date Tested: 12-Apr-21
Tested By: NM
Checked By:

LIQUID LIMIT

Trial No:	1	2	3	4
No of Blows:	37	29	24	18
Container No.	1	2	3	4
Wet Soil + Container	13.04	12.22	13.5	13.4
Dry Soil + Container	7.82	7.25	7.95	7.8
Wt. Of Container	0	0	0	0
Moisture Content	66.8	68.6	69.8	71.8

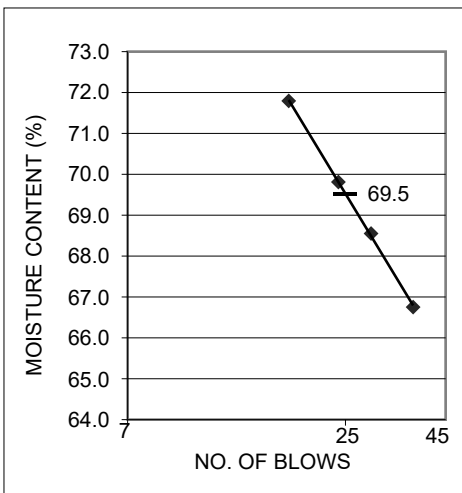

PLASTIC LIMIT

	1	2	AVERAGE
Container No.	5	6	
Wet Soil + Container	28.29	28.49	
Dry Soil + Container	26.27	26.41	
Wt. Of Container	18.91	18.8	
Moisture Content	27.4	27.3	27.4

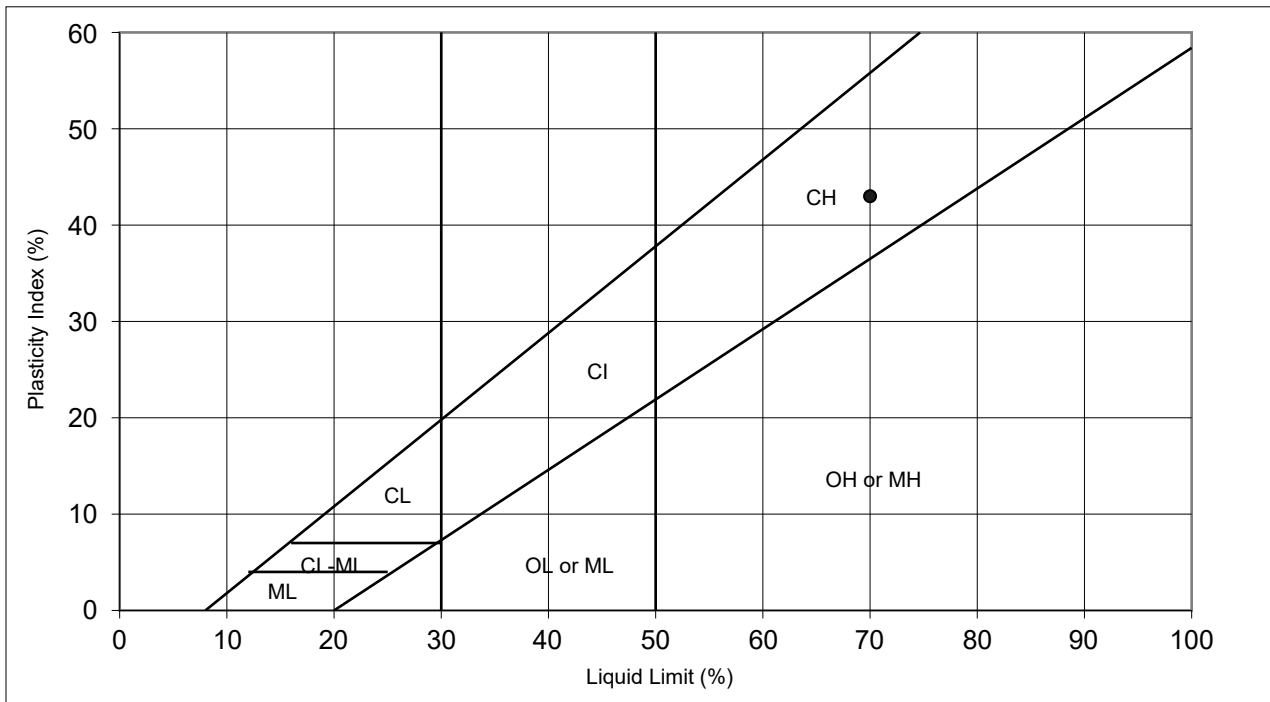

REMARKS

Liquid Limit:	70
Plastic Limit:	27
Plasticity Index:	43
USC Classification:	CH



ATTERBERG LIMITS
ASTM D4318

Client: CIMA+ Canada Inc
Project: Terwillegar Drive Stage 2
Project No: 30442
Test Hole: TH21-6
Sample No: Sa. 4
Depth: 2.29 - 2.74 m

Date Tested: 26-Apr-21
Tested By: NM
Checked By:

LIQUID LIMIT

Trial No:	1	2	3	4
No of Blows:	38	28	23	18
Container No.	1	2	3	4
Wet Soil + Container	13.88	14.52	12.72	12.77
Dry Soil + Container	10.16	10.52	9.16	9.12
Wt. Of Container	0	0	0	0
Moisture Content	36.6	38.0	38.9	40.0

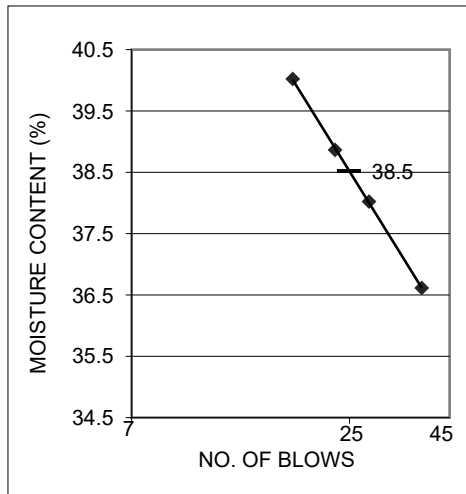

PLASTIC LIMIT

	1	2	AVERAGE
Container No.	5	6	
Wet Soil + Container	28.82	28.9	
Dry Soil + Container	27.42	27.50	
Wt. Of Container	18.8	18.88	
Moisture Content	16.2	16.2	16.2

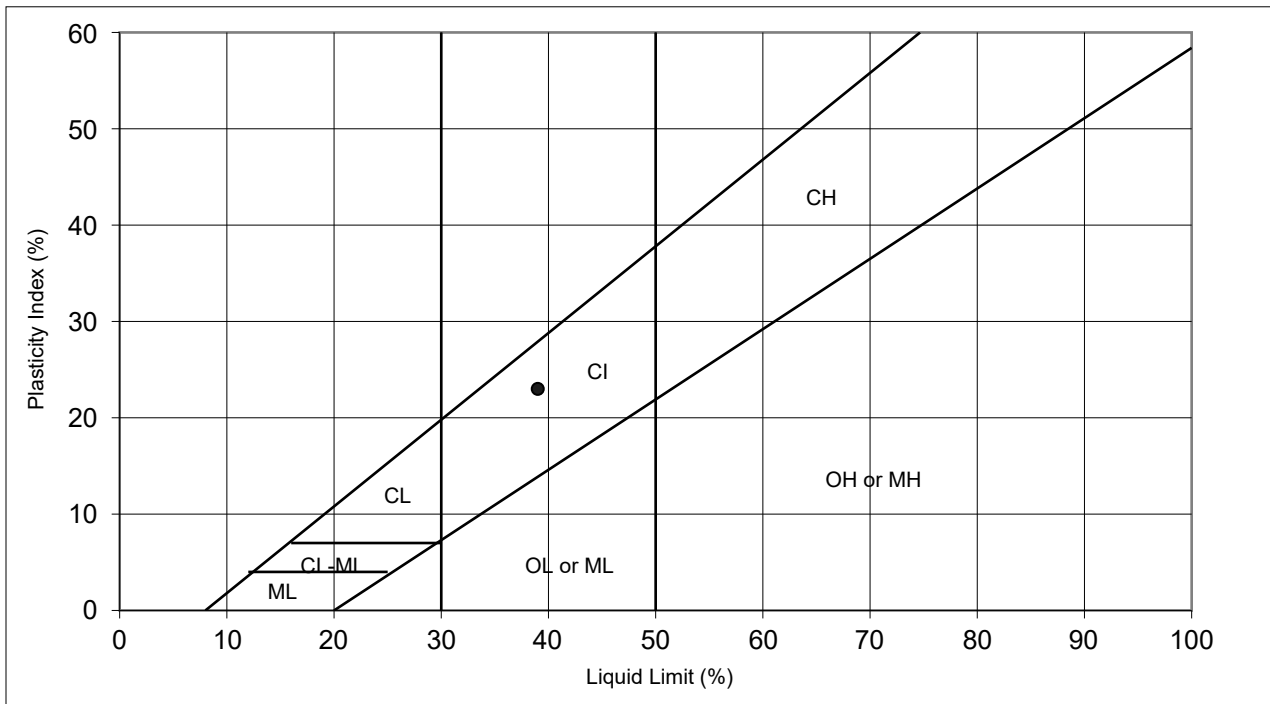

REMARKS

Liquid Limit:	39
Plastic Limit:	16
Plasticity Index:	23
USC Classification:	CI



ATTERBERG LIMITS
ASTM D4318

Client: CIMA+
Project: Terwillegar Drive Stage Two
Project No: 30442
Test Hole: TH21-6
Sample No: Sa. 7
Depth: 3.81 - 4.27 m

Date Tested: 04-May-21
Tested By: LLK
Checked By:

LIQUID LIMIT

Trial No:	1	2	3	4
No of Blows:	41	29	19	13
Container No.	1	2	3	4
Wet Soil + Container	16.84	16.13	16.36	16.79
Dry Soil + Container	10.13	9.60	9.63	9.76
Wt. Of Container	0	0	0	0
Moisture Content	66.2	68.0	69.9	72.0

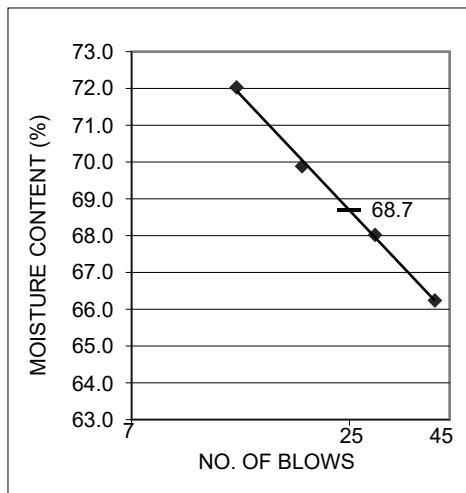

PLASTIC LIMIT

	1	2	AVERAGE
Container No.	5	6	
Wet Soil + Container	28.02	28.06	
Dry Soil + Container	26.03	26.09	
Wt. Of Container	18.76	18.87	
Moisture Content	27.4	27.3	27.3

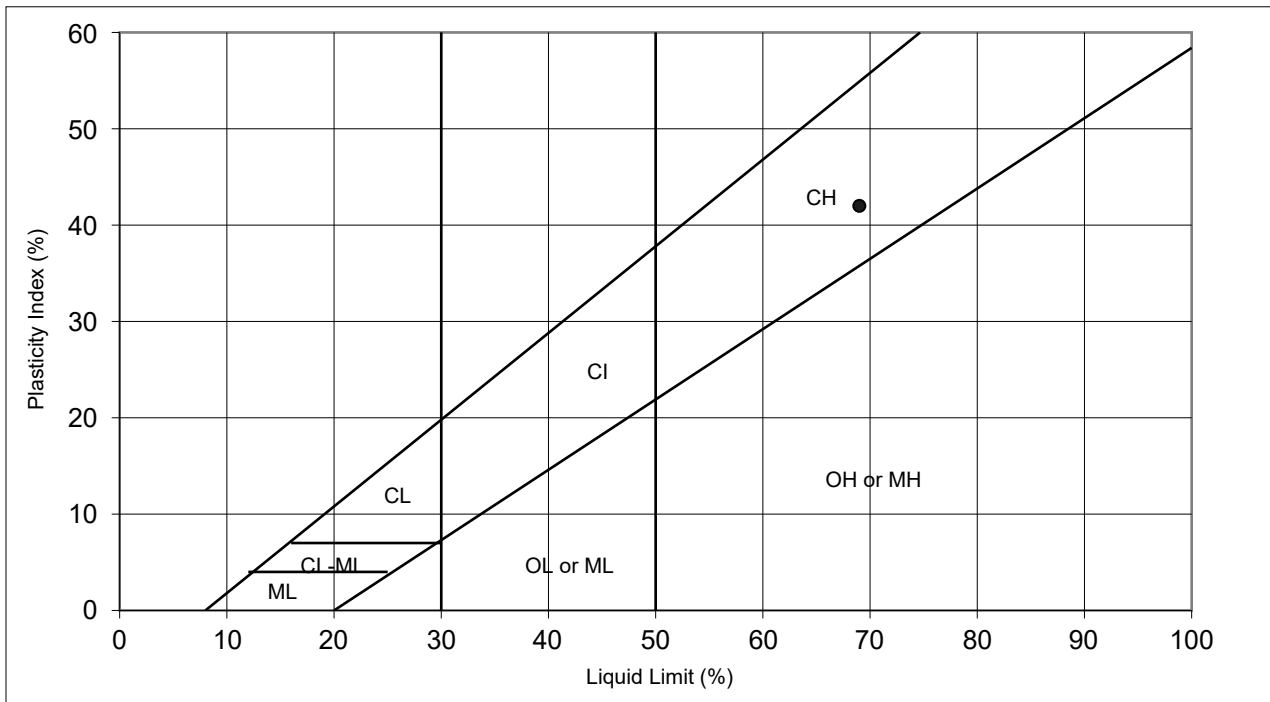

REMARKS

Liquid Limit:	69
Plastic Limit:	27
Plasticity Index:	42
USC Classification:	CH



ATTERBERG LIMITS
ASTM D4318

Client: CIMA+ Canada Inc
Project: Terwillegar Drive Stage 2
Project No: 30442
Test Hole: TH21-6
Sample No: Sa. 10
Depth: 5.33 - 5.79 m

Date Tested: 26-Apr-21
Tested By: NM
Checked By:

LIQUID LIMIT

Trial No:	1	2	3	4
No of Blows:	39	29	23	18
Container No.	1	2	3	4
Wet Soil + Container	12.67	13.98	13.22	12.66
Dry Soil + Container	7.56	8.26	7.76	7.37
Wt. Of Container	0	0	0	0
Moisture Content	67.6	69.2	70.4	71.8

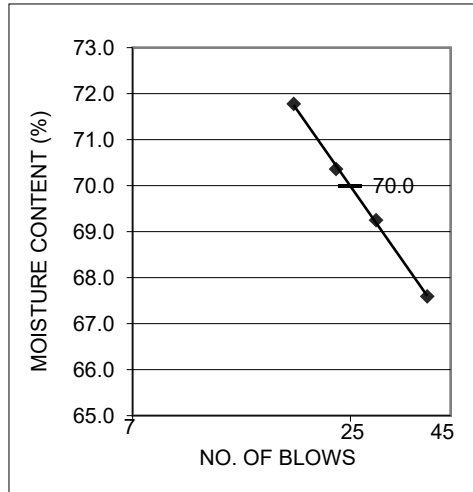

PLASTIC LIMIT

	1	2	AVERAGE
Container No.	5	6	
Wet Soil + Container	27.97	27.84	
Dry Soil + Container	25.96	25.85	
Wt. Of Container	18.89	18.83	
Moisture Content	28.4	28.3	28.4

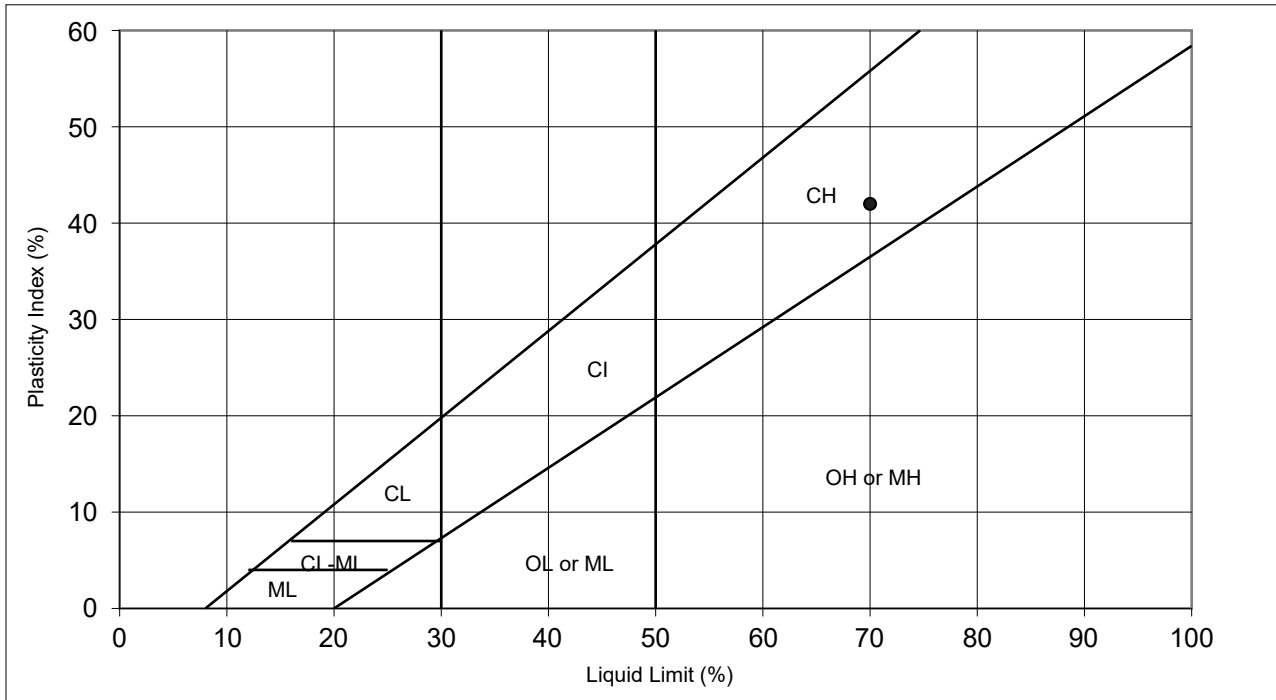

REMARKS

Liquid Limit:	70
Plastic Limit:	28
Plasticity Index:	42
USC Classification:	CH



ATTERBERG LIMITS
ASTM D4318

Client: CIMA+ Canada Inc
Project: Terwillegar Drive Stage 2
Project No: 30442
Test Hole: TH21-6
Sample No: ST15
Depth: 8.38 - 8.84 m

Date Tested: 26-Apr-21
Tested By: NM
Checked By:

LIQUID LIMIT

Trial No:	1	2	3	4
No of Blows:	38	27	21	16
Container No.	1	2	3	4
Wet Soil + Container	12.07	12.95	13.3	13.4
Dry Soil + Container	7.65	8.12	8.28	8.28
Wt. Of Container	0	0	0	0
Moisture Content	57.8	59.5	60.6	61.8

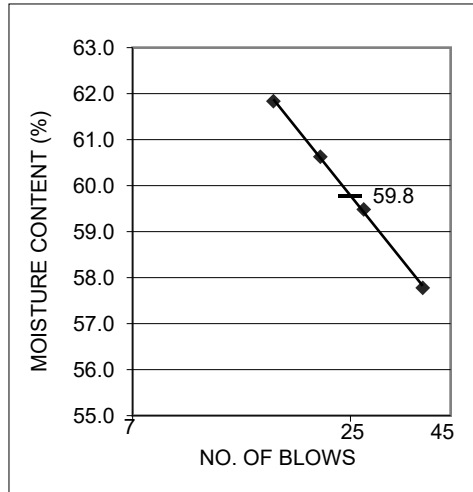

PLASTIC LIMIT

	1	2	AVERAGE
Container No.	5	6	
Wet Soil + Container	28.27	28.6	
Dry Soil + Container	26.4	26.72	
Wt. Of Container	18.81	19	
Moisture Content	24.6	24.4	24.5

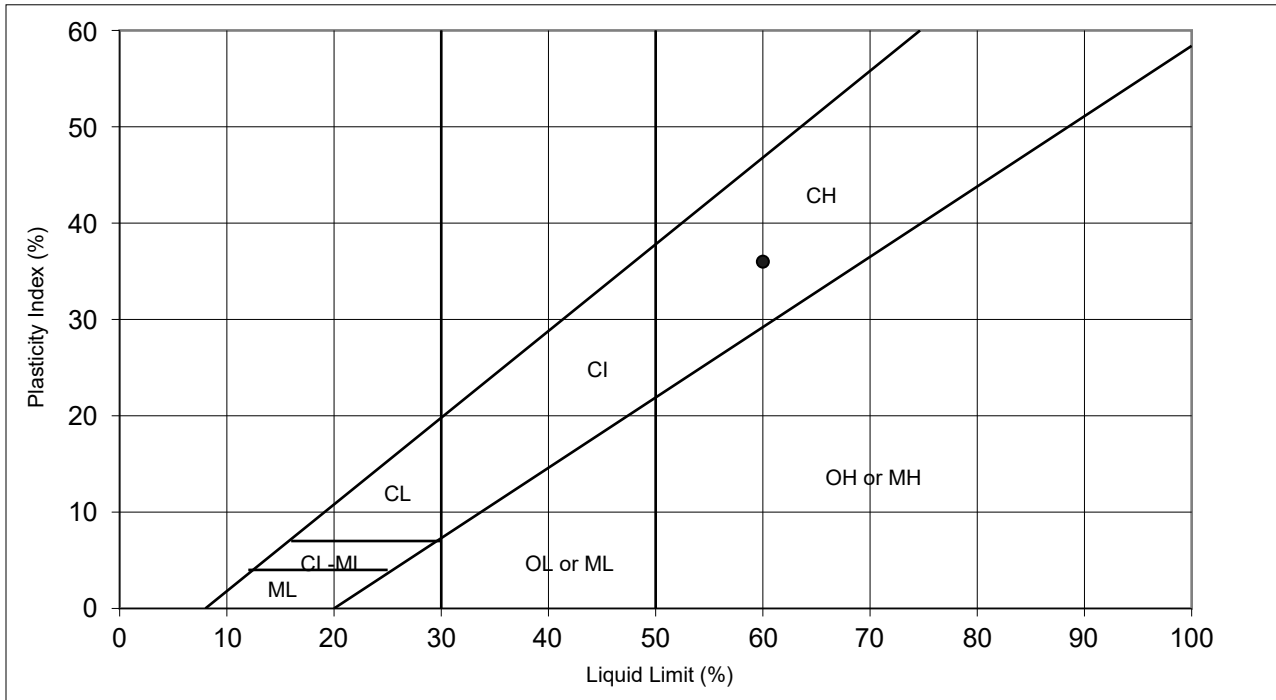

REMARKS

Liquid Limit:	60
Plastic Limit:	24
Plasticity Index:	36
USC Classification:	CH



ATTERBERG LIMITS
ASTM D4318

Client: CIMA+ Canada Inc
Project: Terwillegar Drive Stage 2
Project No: 30442
Test Hole: TH21-6
Sample No: T22
Depth: 12.95 - 13.41 m

Date Tested: 05-May-21
Tested By: NM
Checked By:

LIQUID LIMIT

Trial No:	1	2	3	4
No of Blows:	43	33	23	18
Container No.	1	2	3	4
Wet Soil + Container	13.21	14.70	13.17	14.49
Dry Soil + Container	8.48	9.37	8.31	9.08
Wt. Of Container	0	0	0	0
Moisture Content	55.8	56.9	58.5	59.6

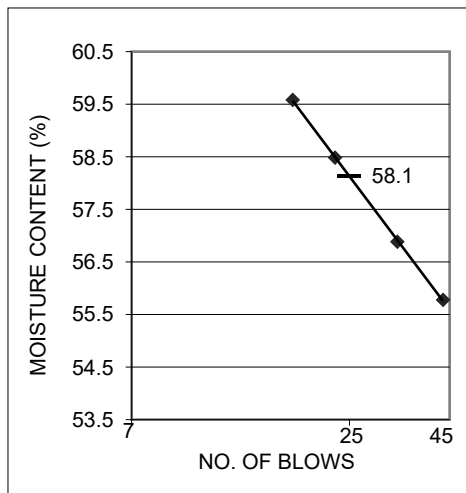

PLASTIC LIMIT

	1	2	AVERAGE
Container No.	5	6	
Wet Soil + Container	28.04	28.3	
Dry Soil + Container	26.21	26.40	
Wt. Of Container	18.8	18.77	
Moisture Content	24.7	24.9	24.8

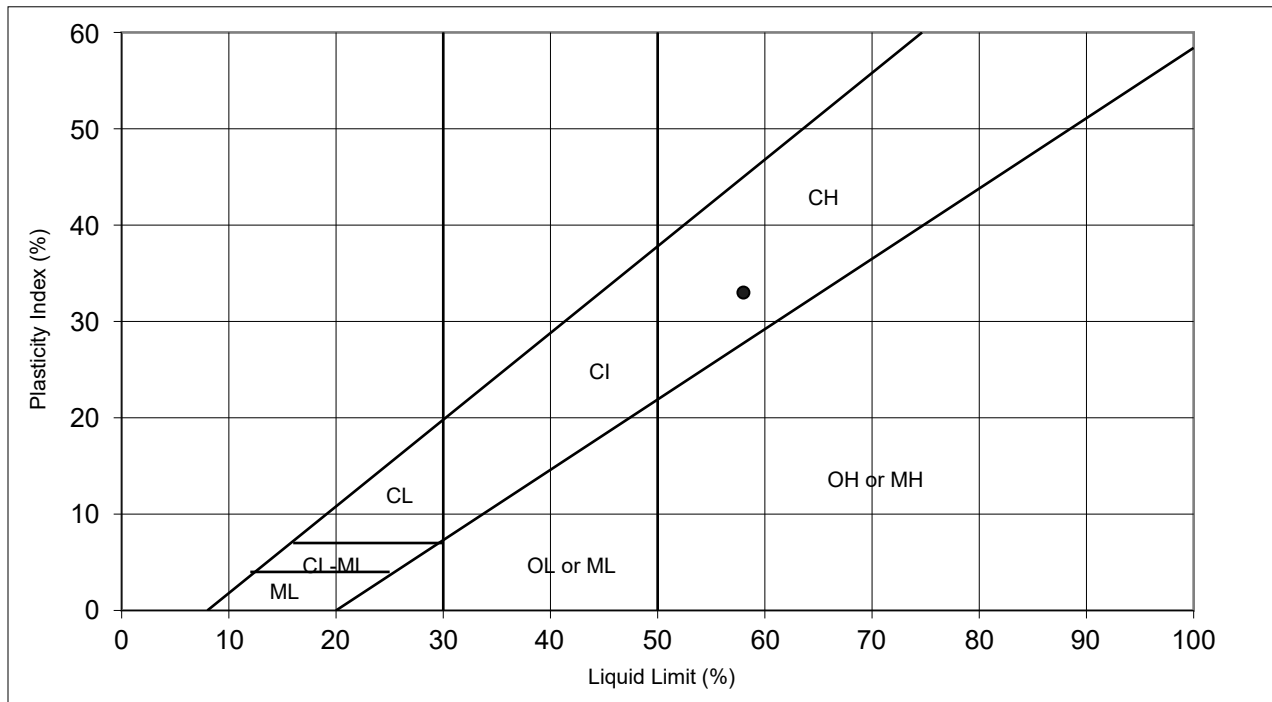

REMARKS

Liquid Limit:	58
Plastic Limit:	25
Plasticity Index:	33
USC Classification:	CH



ATTERBERG LIMITS
ASTM D4318

Client: CIMA+ Canada Inc
Project: Terwillegar Drive Stage 2
Project No: 30442
Test Hole: TH21-7
Sample No: B6
Depth: 3.51 m

Date Tested: 28-Apr-21
Tested By: NM
Checked By:

LIQUID LIMIT

Trial No:	1	2	3	4
No of Blows:	35	28	22	16
Container No.	1	2	3	4
Wet Soil + Container	12.05	12.89	13.33	12.87
Dry Soil + Container	8.59	9.12	9.36	8.94
Wt. Of Container	0	0	0	0
Moisture Content	40.3	41.3	42.4	44.0

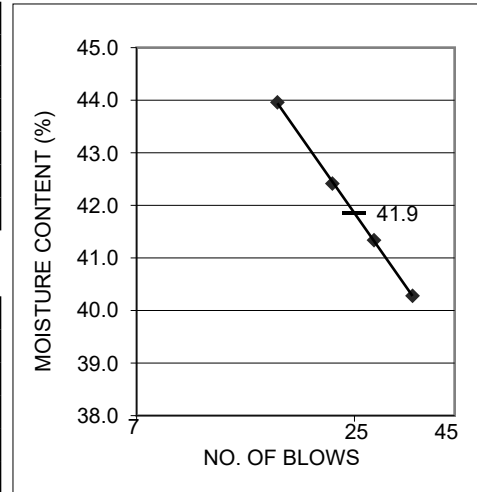

PLASTIC LIMIT

	1	2	AVERAGE
Container No.	5	6	
Wet Soil + Container	28.21	28.58	
Dry Soil + Container	26.49	26.82	
Wt. Of Container	18.75	18.81	
Moisture Content	22.2	22.0	22.1

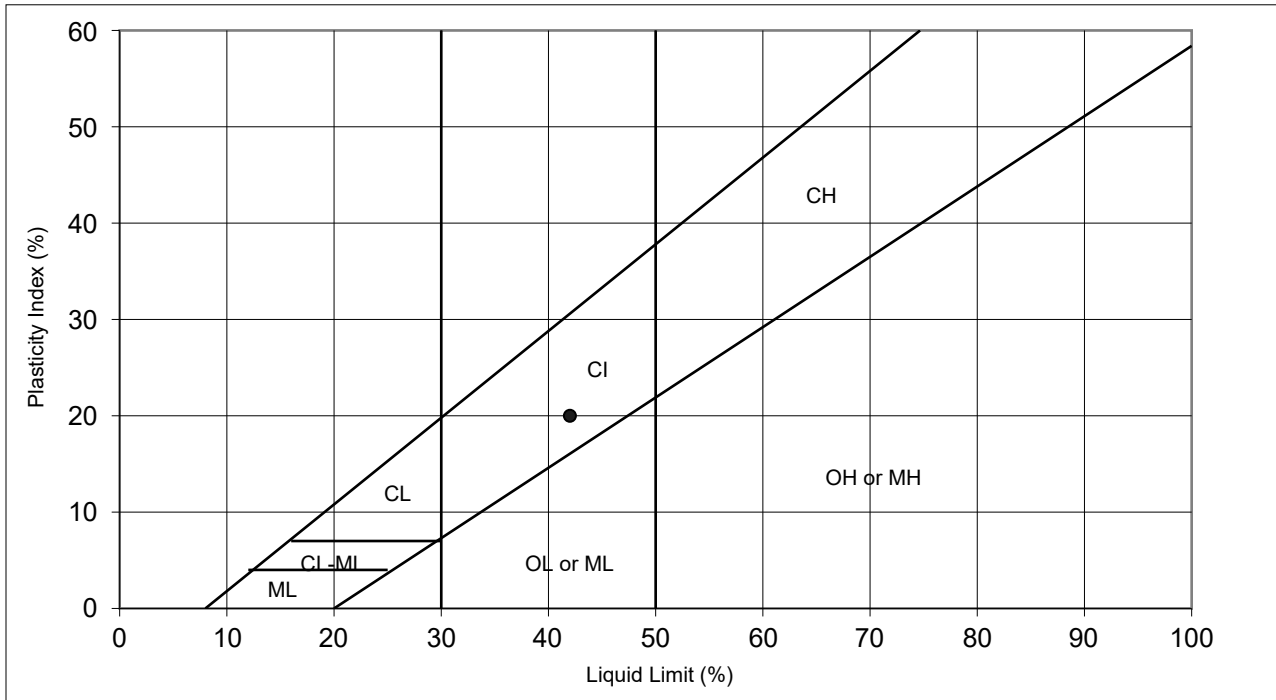

REMARKS

Liquid Limit:	42
Plastic Limit:	22
Plasticity Index:	20
USC Classification:	CI



ATTERBERG LIMITS
ASTM D4318

Client: CIMA+ Canada Inc
Project: Terwillegar Drive Stage 2
Project No: 30442
Test Hole: TH21-7
Sample No: Run 2
Depth: 5.10 - 5.23 m

Date Tested: 26-Apr-21
Tested By: NM
Checked By:

LIQUID LIMIT

Trial No:	1	2	3	4
No of Blows:	38	26	19	14
Container No.	1	2	3	4
Wet Soil + Container	13.28	12.48	12.76	13.51
Dry Soil + Container	8.61	7.98	8.07	8.45
Wt. Of Container	0	0	0	0
Moisture Content	54.2	56.4	58.1	59.9

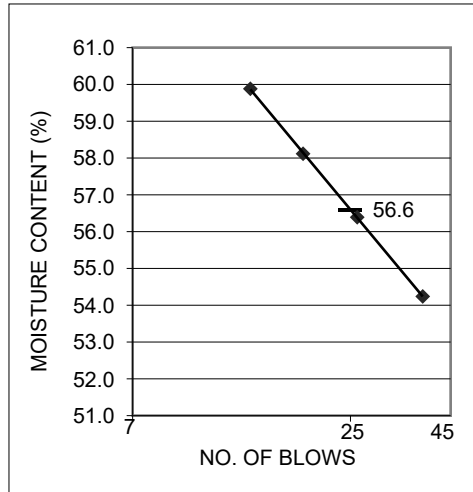

PLASTIC LIMIT

	1	2	AVERAGE
Container No.	5	6	
Wet Soil + Container	28.5	28.35	
Dry Soil + Container	26.48	26.39	
Wt. Of Container	18.74	18.85	
Moisture Content	26.1	26.0	26.0

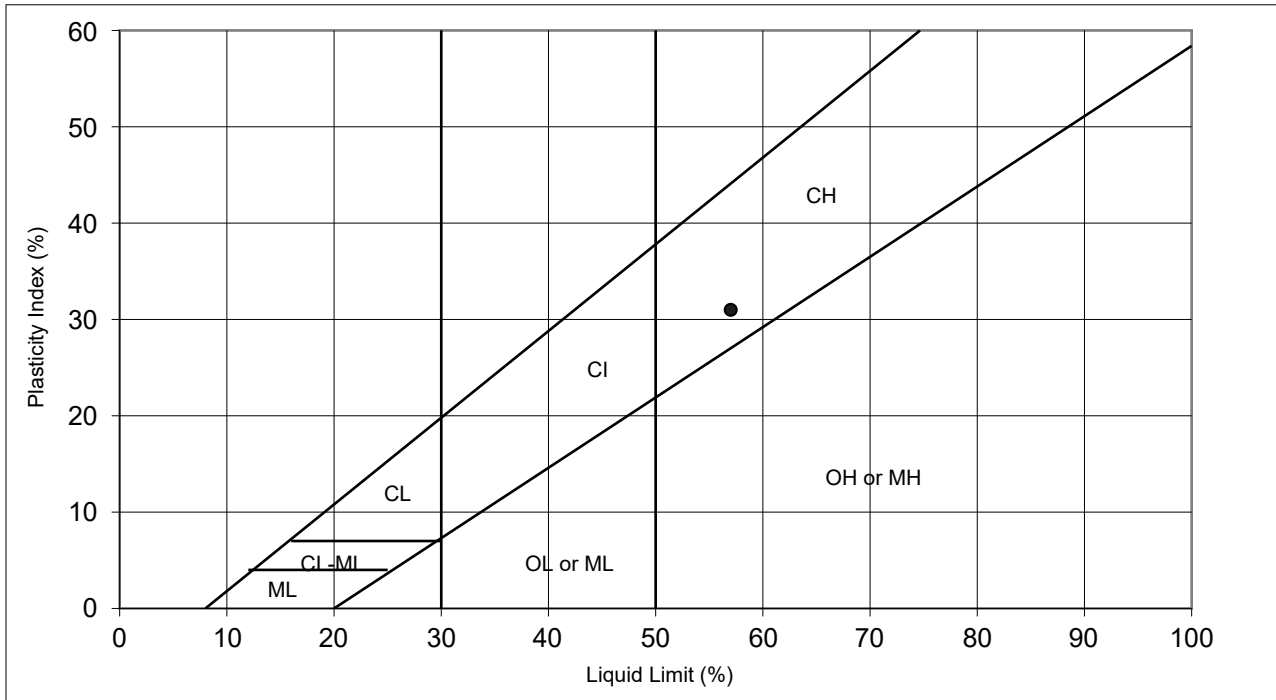

REMARKS

Liquid Limit:	57
Plastic Limit:	26
Plasticity Index:	31
USC Classification:	CH



ATTERBERG LIMITS
ASTM D4318

Client: CIMA+ Canada Inc
Project: Terwillegar Drive Stage 2
Project No: 30442
Test Hole: TH21-8
Sample No: Sa. 3
Depth: 2.29 - 2.74 m

Date Tested: 26-Apr-21
Tested By: NM
Checked By:

LIQUID LIMIT

Trial No:	1	2	3	4
No of Blows:	34	29	24	19
Container No.	1	2	3	4
Wet Soil + Container	13.89	13.51	12.81	12.61
Dry Soil + Container	8.99	8.69	8.18	7.98
Wt. Of Container	0	0	0	0
Moisture Content	54.5	55.5	56.6	58.0

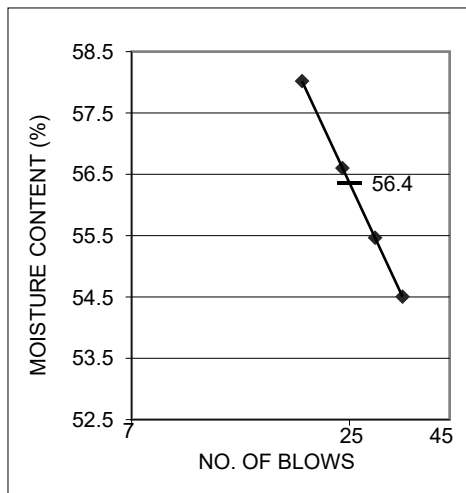

PLASTIC LIMIT

	1	2	AVERAGE
Container No.	5	6	
Wet Soil + Container	28.48	28.2	
Dry Soil + Container	26.76	26.55	
Wt. Of Container	18.93	18.97	
Moisture Content	22.0	21.8	21.9

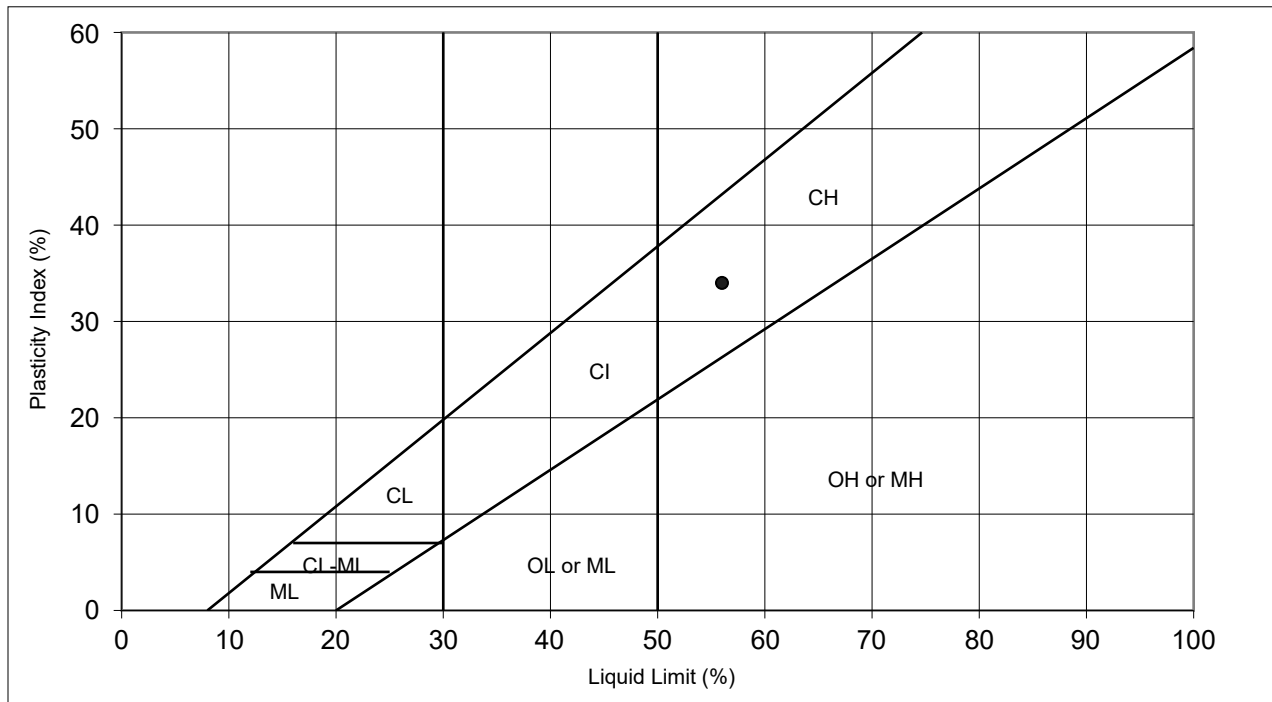

REMARKS

Liquid Limit:	56
Plastic Limit:	22
Plasticity Index:	34
USC Classification:	CH



ATTERBERG LIMITS
ASTM D4318

Client: CIMA+ Canada Inc
Project: Terwillegar Drive Stage 2
Project No: 30442
Test Hole: TH21-10
Sample No: B4
Depth: 3.51 m

Date Tested: 28-Apr-21
Tested By: NM
Checked By:

LIQUID LIMIT

Trial No:	1	2	3	4
No of Blows:	39	30	23	18
Container No.	1	2	3	4
Wet Soil + Container	12.82	12.96	12.8	13.54
Dry Soil + Container	9.1	9.11	8.91	9.33
Wt. Of Container	0	0	0	0
Moisture Content	40.9	42.3	43.7	45.1

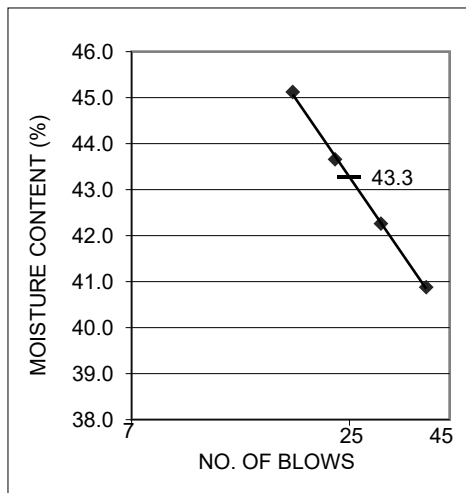

PLASTIC LIMIT

	1	2	AVERAGE
Container No.	5	6	
Wet Soil + Container	28.24	28.02	
Dry Soil + Container	26.6	26.42	
Wt. Of Container	18.77	18.77	
Moisture Content	20.9	20.9	20.9

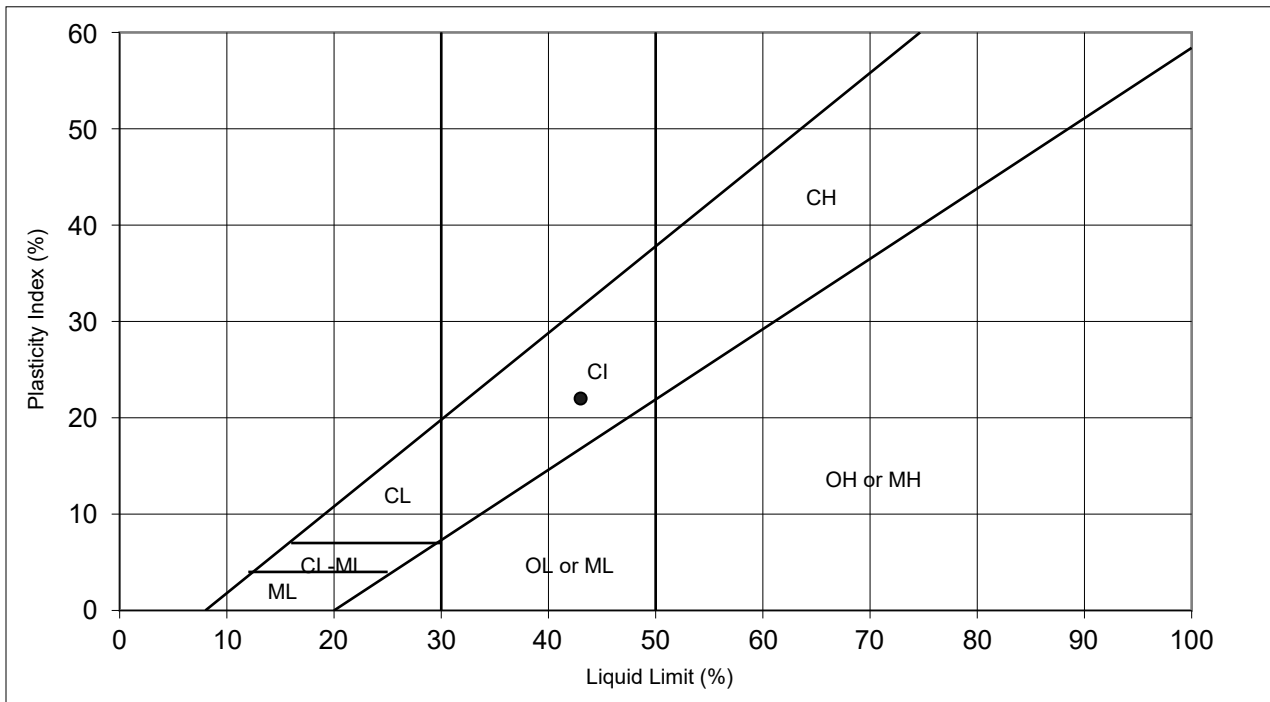

REMARKS

Liquid Limit:	43
Plastic Limit:	21
Plasticity Index:	22
USC Classification:	CI



ATTERBERG LIMITS
ASTM D4318

Client: CIMA+ Canada Inc
Project: Terwillegar Drive Stage 2
Project No: 30442
Test Hole: TH21-11
Sample No: B3
Depth: 1.52 m

Date Tested: 27-Apr-21
Tested By: JAP
Checked By:

LIQUID LIMIT

Trial No:	1	2	3	4
No of Blows:	44	31	25	16
Container No.	1	2	3	4
Wet Soil + Container	15.13	16.53	15.51	15.23
Dry Soil + Container	10.25	10.99	10.21	9.79
Wt. Of Container	0	0	0	0
Moisture Content	47.6	50.4	51.9	55.6

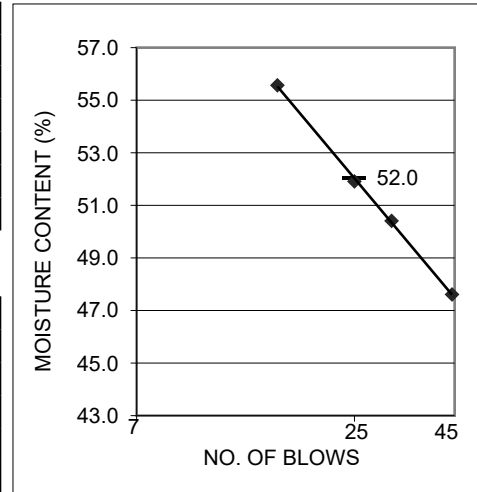

PLASTIC LIMIT

	1	2	AVERAGE
Container No.	5	6	
Wet Soil + Container	28.42	27.33	
Dry Soil + Container	26.73	25.85	
Wt. Of Container	18.89	18.89	
Moisture Content	21.6	21.3	21.4

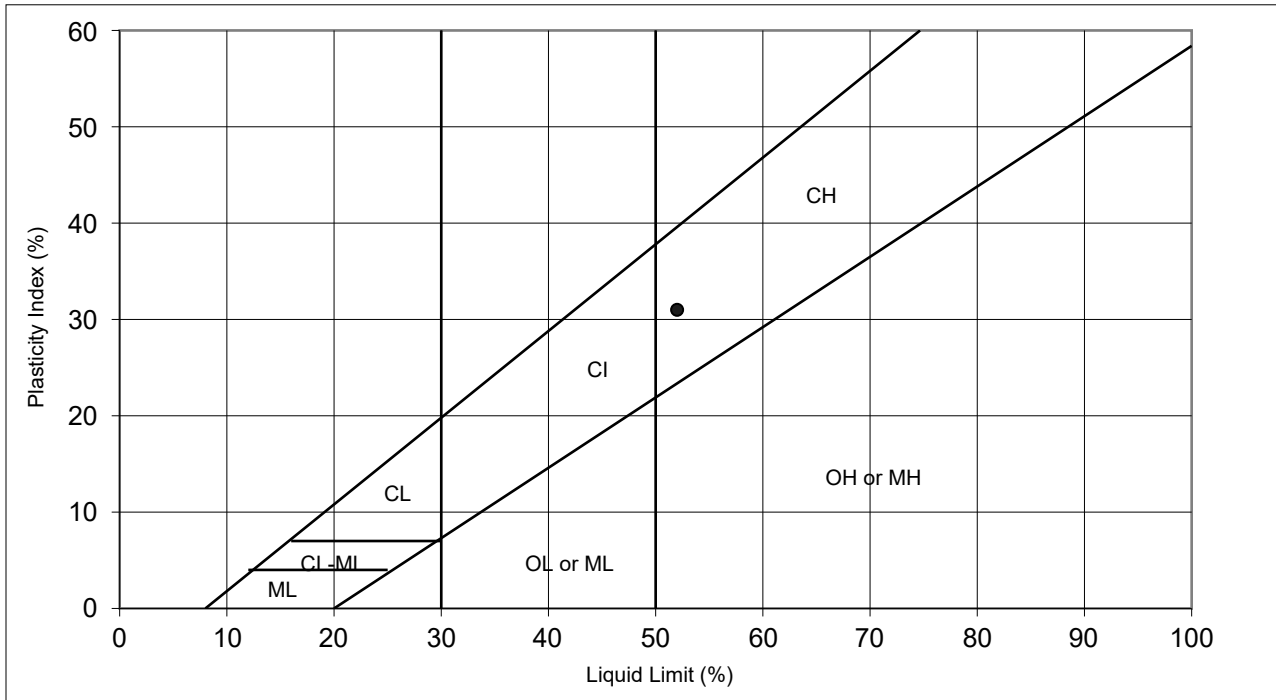

REMARKS

Liquid Limit:	52
Plastic Limit:	21
Plasticity Index:	31
USC Classification:	CH



ATTERBERG LIMITS
ASTM D4318

Client: CIMA+ Canada Inc
Project: Terwillegar Drive Stage 2

Project No: 30442

Test Hole: TH21-12 Depth: 5.03 m
Sample No.: B9

Date Tested: 02-May-21

Tested By: NM

Checked By:

LIQUID LIMIT

Trial No:	1	2	3	4
No of Blows:	36	29	23	16
Container No.	1	2	3	4
Wet Soil + Container	15.96	14.96	15.19	12.66
Dry Soil + Container	8.33	7.75	7.81	6.43
Wt. Of Container	0	0	0	0
Moisture Content	91.6	93.0	94.5	96.9

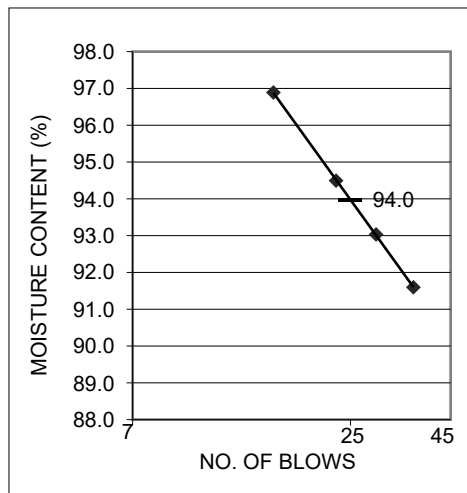

PLASTIC LIMIT

	1	2	3	AVERAGE
Container No.	5	6		
Wet Soil + Container	28.17	28.61		
Dry Soil + Container	26.24	26.55		
Wt. Of Container	19.02	18.86		
Moisture Content	26.7	26.8		26.8

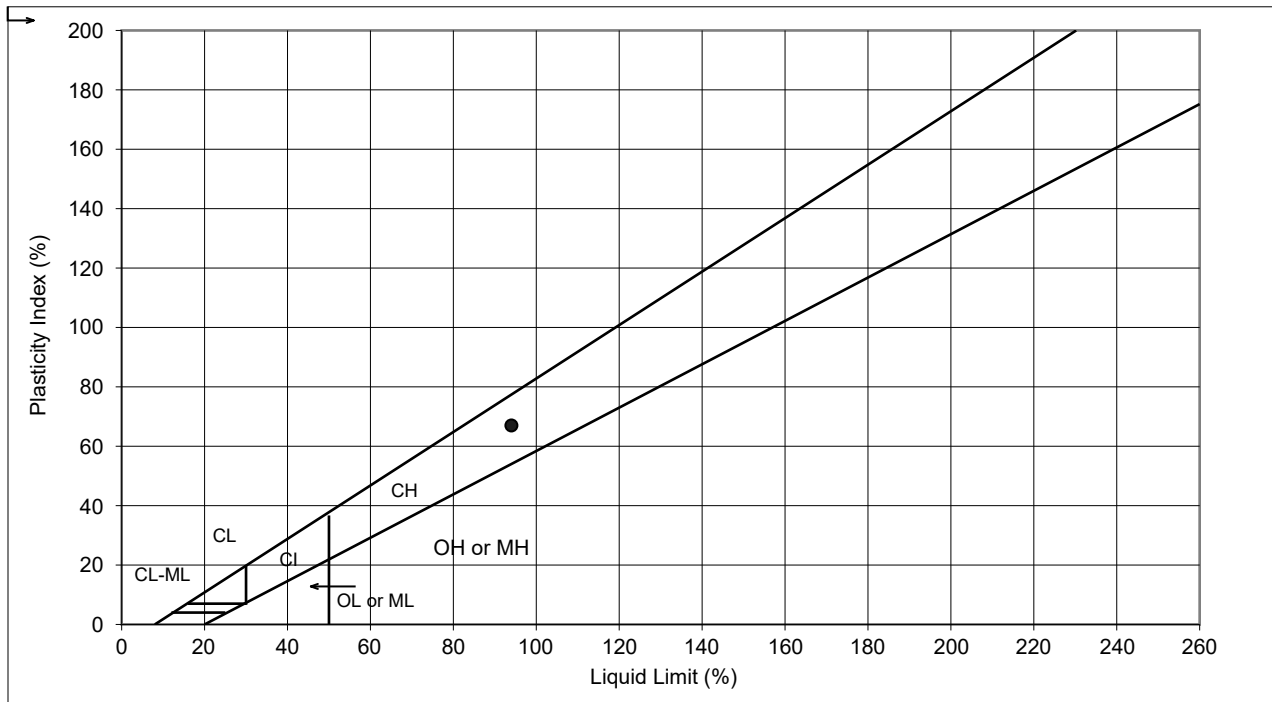

REMARKS : Blenderized Limit

Liquid Limit:	94
Plastic Limit:	27
Plasticity Index:	67
USC Classification:	CH



THURBER ENGINEERING LTD.

4127 Roper Road Edmonton, AB T6B 3S5 T. (780) 438 - 1460 F. (780) 437 - 7125 www.thurber.ca

GRAIN SIZE DISTRIBUTION REPORT

Client: CIMA+
Project: Terwillegar Drive Stage Two
Project No: 30442

Date Tested: 06-May-21

Tested By: JAP

Test Hole: TH21-4

Depth: 2.29 - 2.74 m

Sample Description:

Sample No.: ST4

Sieve Size -mm	Percent Finer
100.0	100.0
75.0	100.0
62.5	100.0
50.0	100.0
37.5	100.0
25.0	100.0
19.0	100.0
12.5	100.0
9.5	100.0
4.75	100.0
2.00	100.0
0.850	99.9
0.425	99.9
0.250	99.3
0.150	91.8
0.075	51.3
0.062	46.4
0.046	37.5
0.033	32.4
0.021	28.2
0.012	25.8
0.009	25.4
0.006	23.8
0.004	22.4
0.003	21.0
0.002	20.5

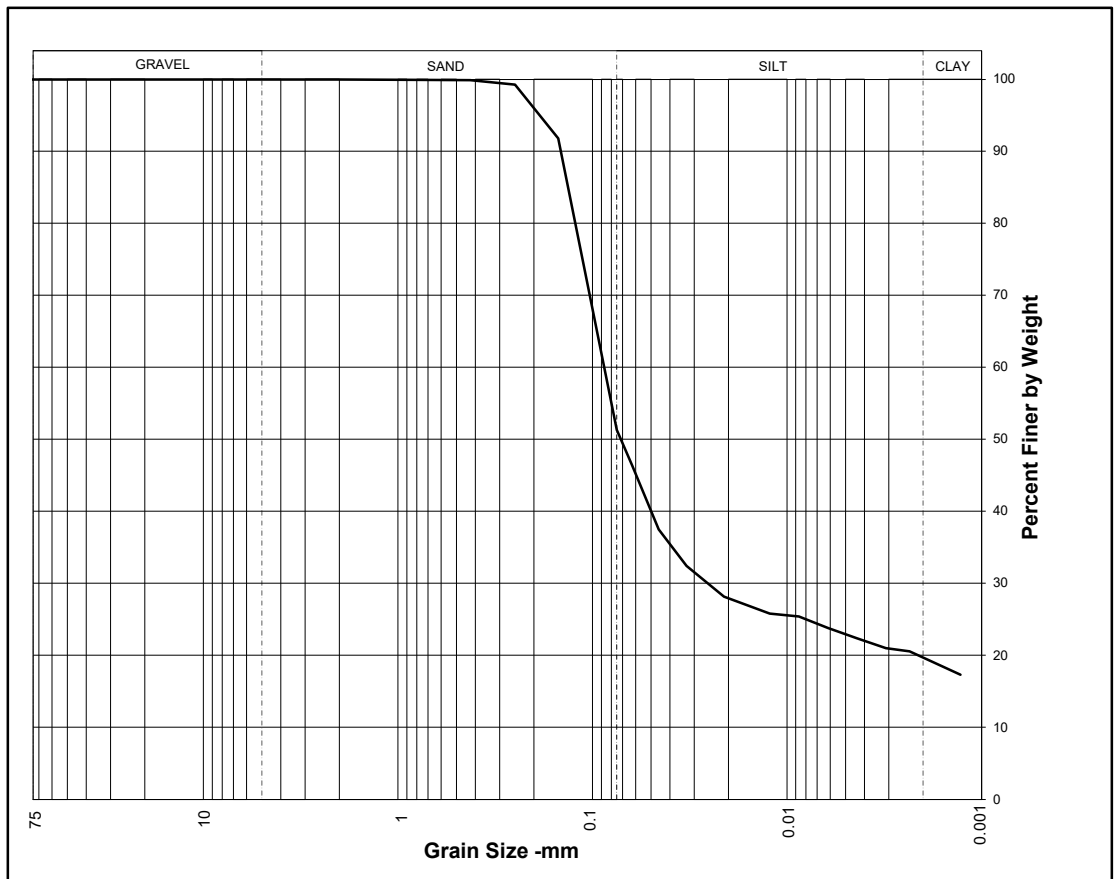

Distribution	
Cobbles	0%
Gravel	0%
Sand	48.7%
Silt	31.8%
Clay	19.5%

Remarks:

Checked By:

Tested in Accordance with ASTM D422, C136 and C117 unless otherwise indicated



THURBER ENGINEERING LTD.

4127 Roper Road Edmonton, AB T6B 3S5 T. (780) 438 - 1460 F. (780) 437 - 7125 www.thurber.ca

GRAIN SIZE DISTRIBUTION REPORT

Client: CIMA+
Project: Terwillegar Drive Stage 2
Project No: 30442

Date Tested: 27-Apr-21

Tested By: JAP

Test Hole: TH21-9
Sample Description:

Depth: 2.29 - 2.74 m

Sample No.: P4

Sieve Size -mm	Percent Finer
100.0	100.0
75.0	100.0
62.5	100.0
50.0	100.0
37.5	100.0
25.0	100.0
19.0	100.0
12.5	100.0
9.5	100.0
4.75	100.0
2.00	100.0
0.850	99.9
0.425	99.9
0.250	99.3
0.150	93.0
0.075	64.2
0.057	54.3
0.042	48.0
0.031	40.7
0.020	33.8
0.012	28.5
0.008	26.1
0.006	23.8
0.004	21.8
0.003	19.7
0.002	17.4

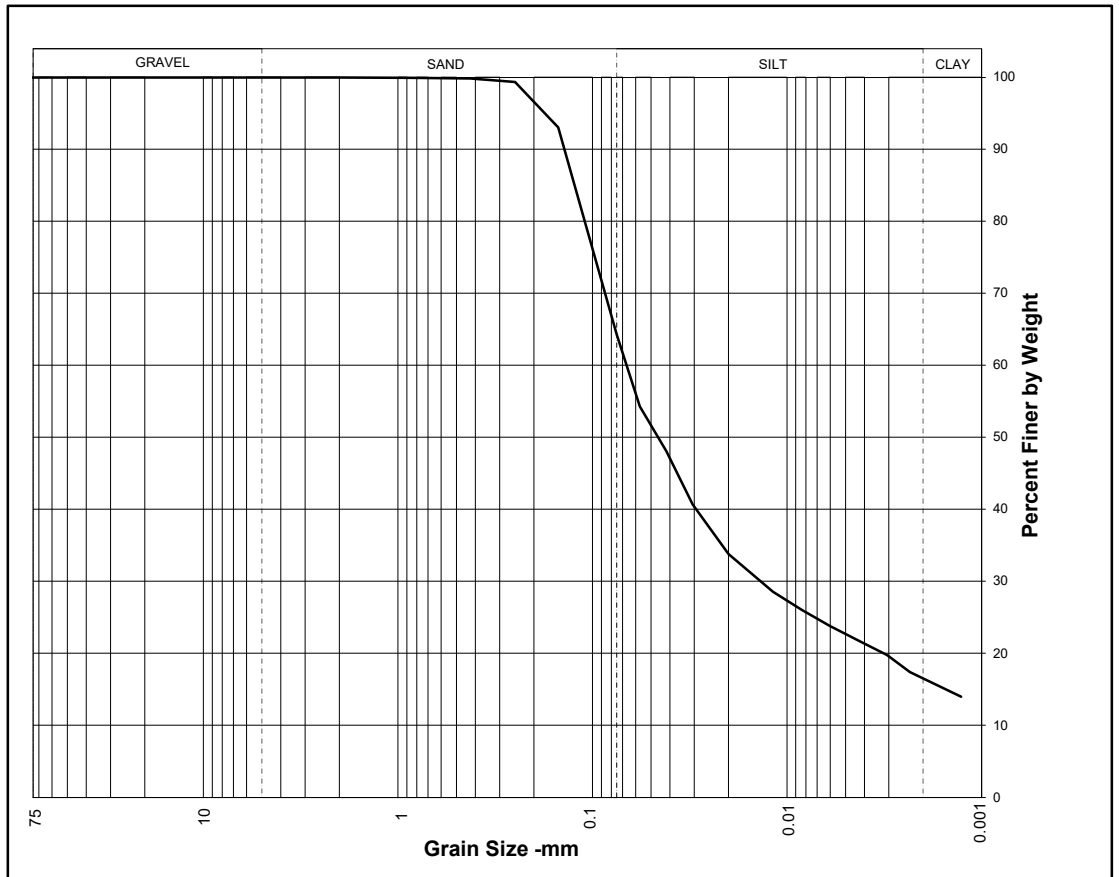

Distribution	
Cobbles	0%
Gravel	0%
Sand	35.8%
Silt	47.9%
Clay	16.3%

Remarks:

Checked By:

Tested in Accordance with ASTM D422, C136 and C117 unless otherwise indicated



THURBER ENGINEERING LTD.

4127 Roper Road Edmonton, AB T6B 3S5 T. (780) 438 - 1460 F. (780) 437 - 7125 www.thurber.ca

GRAIN SIZE DISTRIBUTION REPORT

Client: CIMA+

Date Tested: 27-Apr-21

Project: Terwillegar Drive Stage 2

Project No: 30442

Tested By: JAP

Test Hole: TH21-11

Depth: 1.52 m

Sample Description:

Sample No.: B3

Sieve Size -mm	Percent Finer
100.0	100.0
75.0	100.0
62.5	100.0
50.0	100.0
37.5	100.0
25.0	100.0
19.0	100.0
12.5	100.0
9.5	100.0
4.75	99.6
2.00	99.1
0.850	97.8
0.425	95.7
0.250	92.0
0.150	82.2
0.075	66.6
0.057	63.0
0.041	59.6
0.029	55.6
0.019	50.5
0.011	45.3
0.008	41.9
0.006	38.7
0.004	35.4
0.003	32.8
0.002	29.8

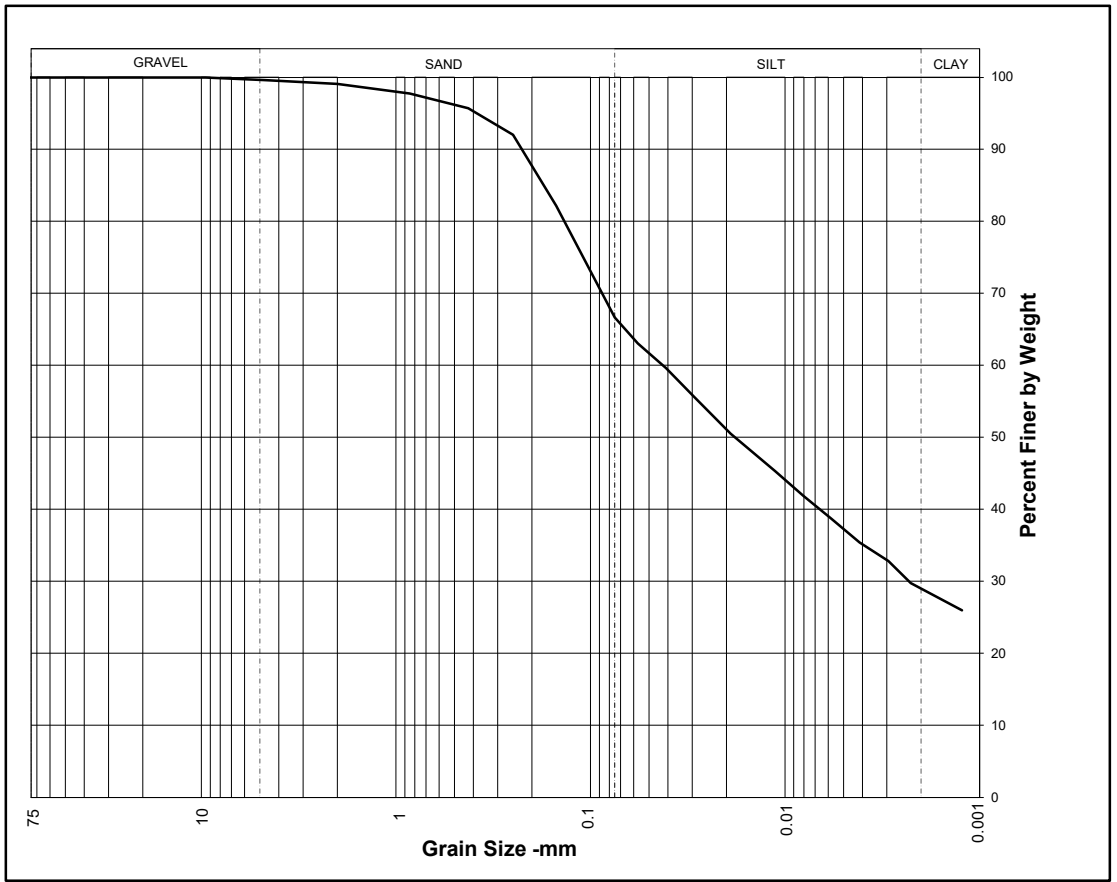

Distribution	
Cobbles	0%
Gravel	0.4%
Sand	33%
Silt	37.8%
Clay	28.8%

Remarks:

Checked By:

Tested in Accordance with ASTM D422, C136 and C117 unless otherwise indicated



THURBER ENGINEERING LTD.

Direct Shear Test Results

Client: CIMA+
Project: Terwillegar Drive Stage II
Job No.: 30442

Test Hole: TH21-7
Sample: Clay Shale(CI),
silty, grey.
Depth: 5.10 - 5.23 m
Date: April 29/21

Peak Strength Parameters:
 $c' = 111\text{kPa}$ $\Phi' = 29^\circ$
Residual Strength Parameters:
 $c' = 0\text{ kPa}$ $\Phi' = 20^\circ$

Δ Peak Strength
 \bullet Residual Strength

Atterberg Limits: LL= 57% PL= 26% PI= 31%

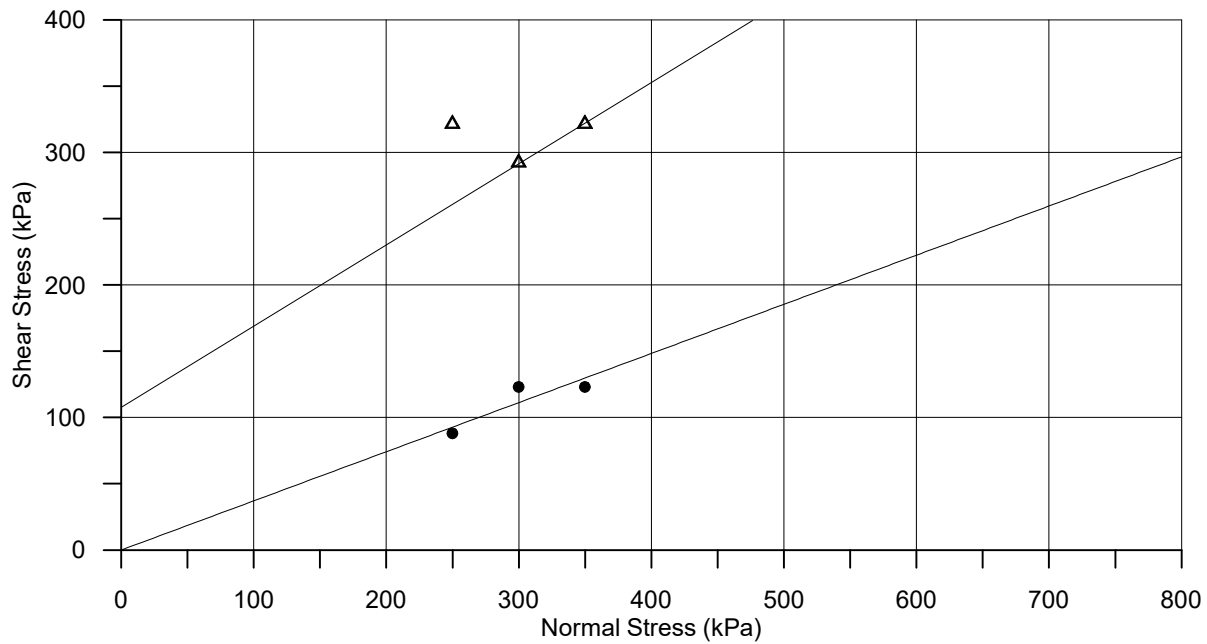

Remarks:

ONE DIMENSIONAL CONSOLIDATION TEST REPORT TEST SUMMARY PLOTS

CIMA+
FILE NUMBER: 30442

REPORT DATE: April 13/21
REPORT NUMBER: CO21-1

Terwillegar Drive Stage II

Sample: TH21-05 @ 5.33 - 5.79m

Void Ratio (end of load increment) Vs Log of Pressure

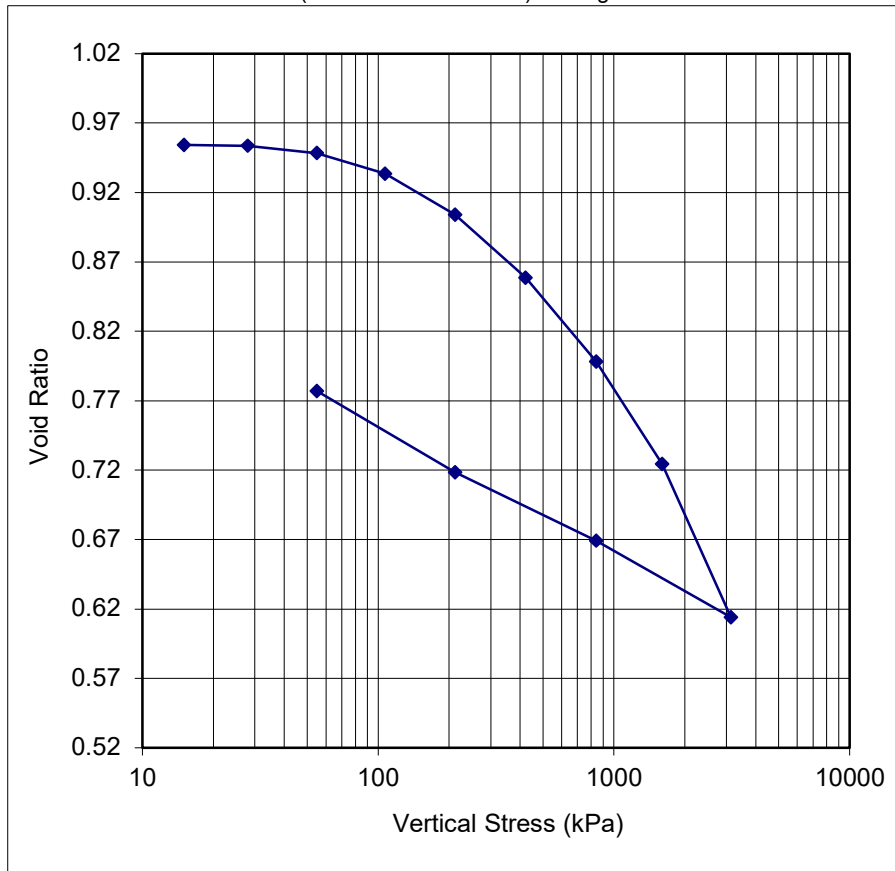

Average Void Ratio Vs Coefficient of Consolidation

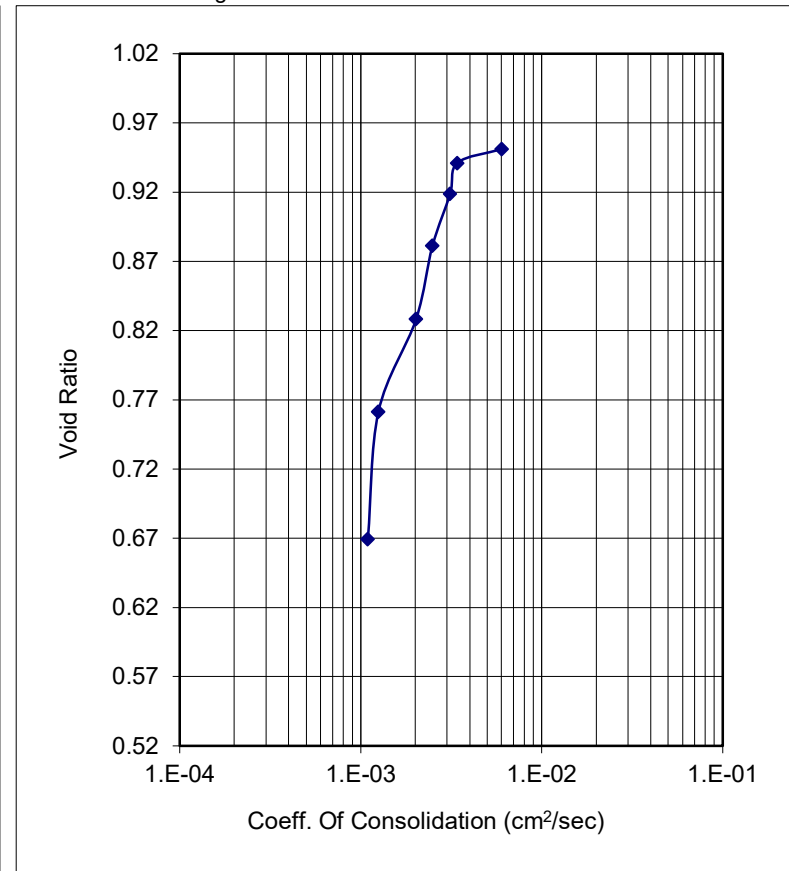

Preconsolidation Pressure: 360 kPa

Compression Index: 0.274

Re-compression Index: 0.093

ONE DIMENSIONAL CONSOLIDATION TEST REPORT TEST SUMMARY PLOTS

CIMA+
FILE NUMBER: 30442

REPORT DATE: April 26/21
REPORT NUMBER: CO21-2

Terwillegar Drive Stage II

Sample: TH21-06 @ 8.38 - 8.84m

Void Ratio (@ T_{100}) Vs Log of Pressure

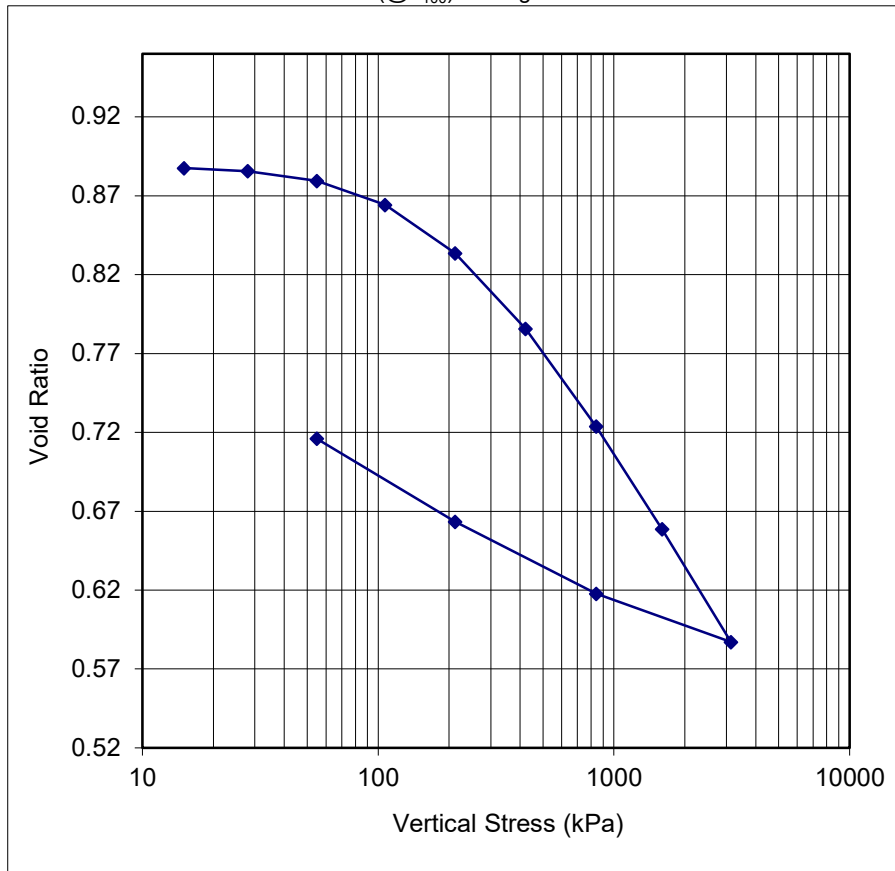

Average Void Ratio Vs Coefficient of Consolidation

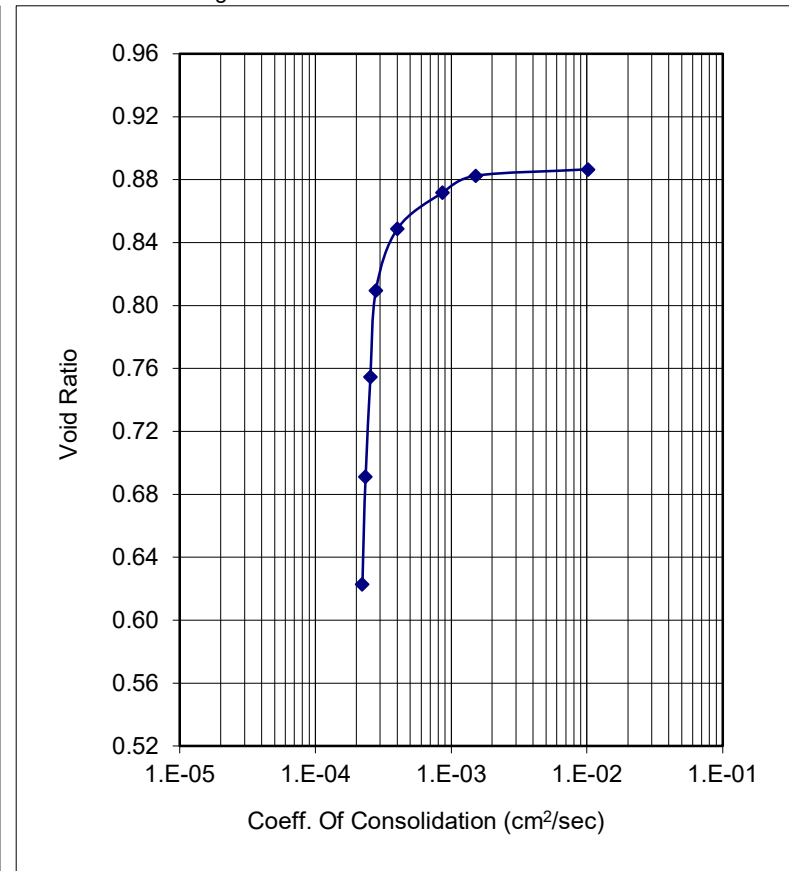

Preconsolidation Pressure: 305 kPa

Compression Index: 0.243

Re-compression Index: 0.073

ONE DIMENSIONAL CONSOLIDATION TEST REPORT TEST SUMMARY PLOTS

CIMA+
FILE NUMBER: 30442

REPORT DATE: 28-Apr-21
REPORT NUMBER: CO21-3

Terwillegar Drive Stage II

Sample: TH21-08 @ 2.29 - 2.74m

Void Ratio (@ T_{100}) Vs Log of Pressure

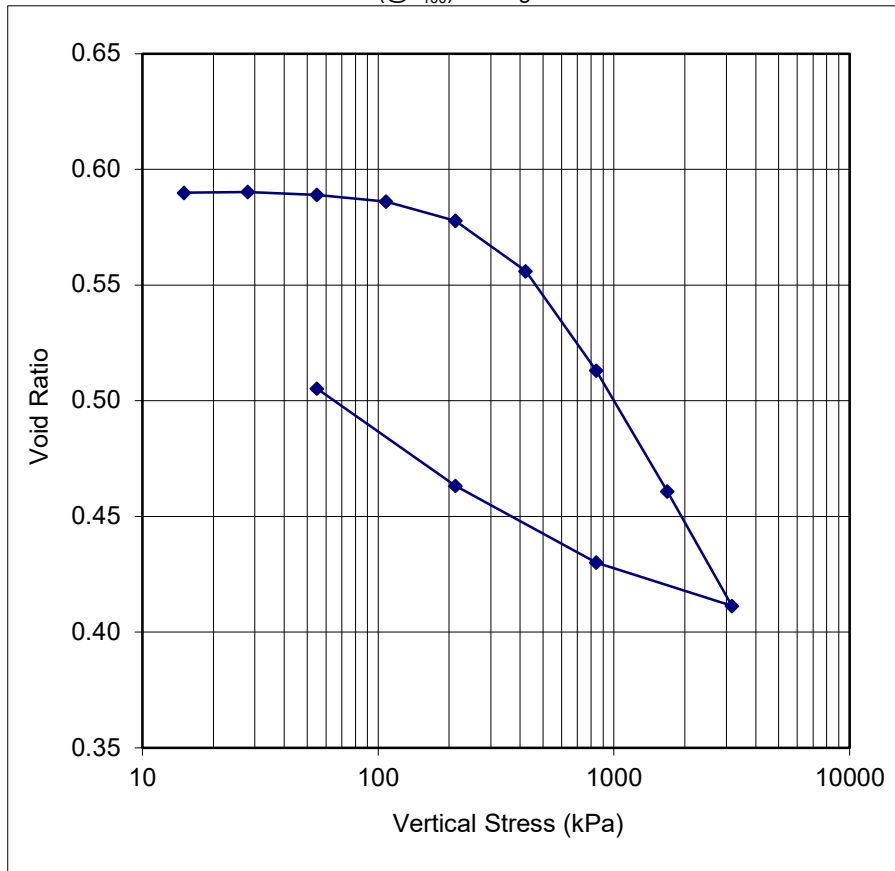

Average Void Ratio Vs Coefficient of Consolidation

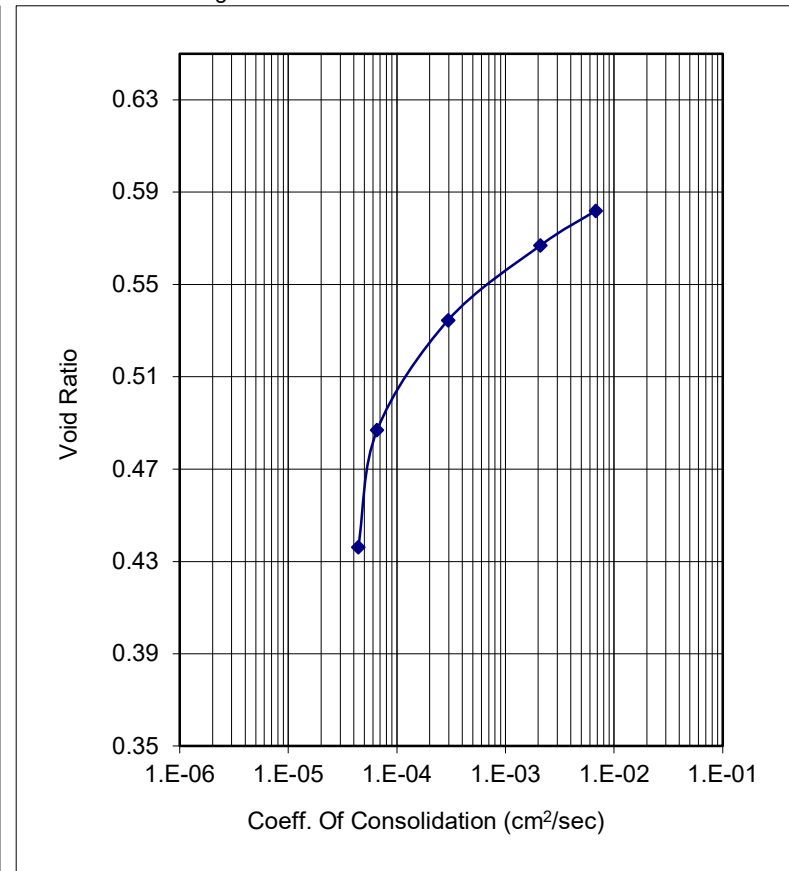

Preconsolidation Pressure: 430 kPa

Compression Index: 0.18

Re-compression Index: 0.053

THURBER ENGINEERING LTD. CYCLIC COMPRESSION TEST REPORT

CIMA+
FILE NUMBER : 30442

REPORT DATE: April 29/21
REPORT NUMBER: CC21-1

Terwillegar Drive Stage II

TEST DATE: April 28/21
 SAMPLE: TH21-4 @ 2.29 - 2.74 m
 DESCRIPTION: Sandstone (SC), fine (to med.) grain, bentonitic, silty, trace oxides stains, brown and grey.

SPECIMEN DETAILS:

Wet Density (kg/m³): 2157
 Dry Density (kg/m³): 1857
 Water Content (%): 16.2

Liquid Limit (%):
 Plastic Limit (%):
 Plasticity Index (%):

Gravel (%):
 Sand (%):
 Silt (%):
 Clay (%):

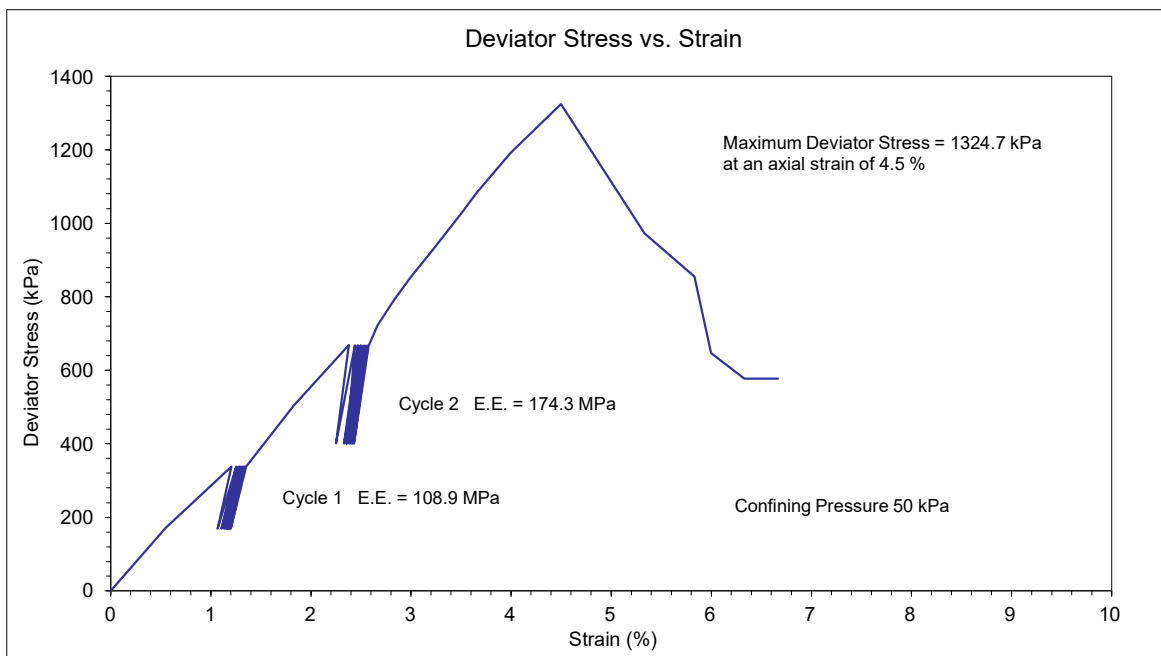

THURBER ENGINEERING LTD. CYCLIC COMPRESSION TEST REPORT

CIMA+
FILE NUMBER : 30442

REPORT DATE: April 29/21
REPORT NUMBER: CC21-2

Terwillegar Drive Stage II

TEST DATE: April 28/21
 SAMPLE: TH21-6 @ 12.95 - 13.41 m
 DESCRIPTION: Clay Shale (CH), reworked, slightly bentonitic, silty, trace siltstone and sandstone pockets, clay shale nodules, coal chips, oxides, brown and grey.

SPECIMEN DETAILS:

Wet Density (kg/m³): 1985
 Dry Density (kg/m³): 1623
 Water Content (%): 22.3

Liquid Limit (%):
 Plastic Limit (%):
 Plasticity Index (%):

Gravel (%):
 Sand (%):
 Silt (%):
 Clay (%):

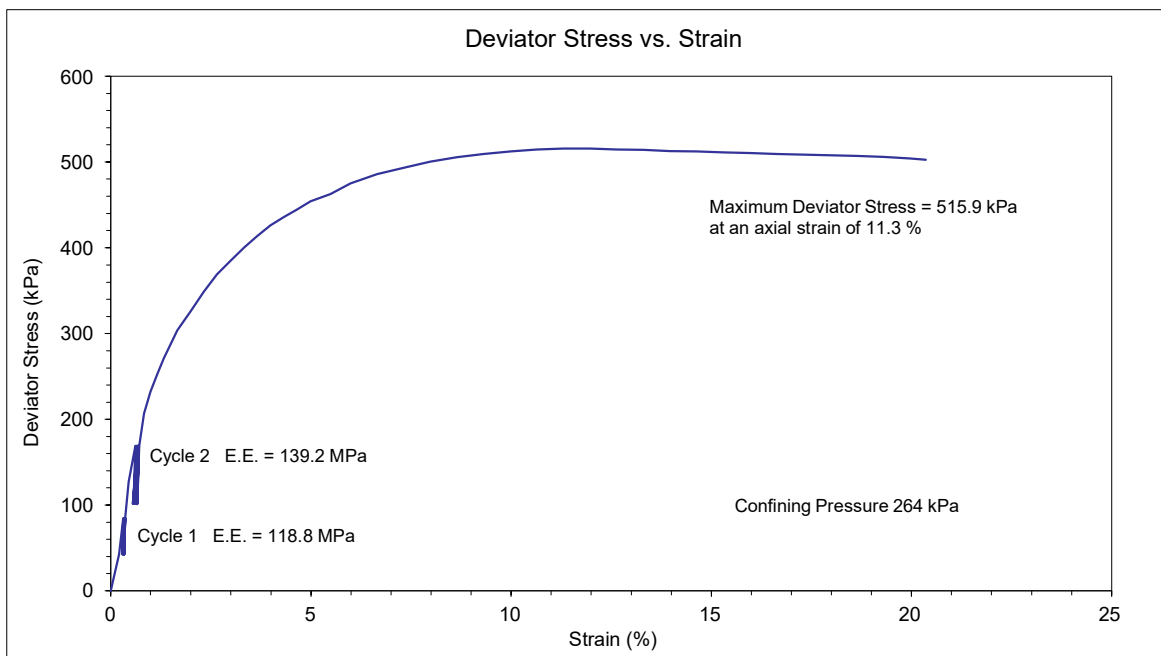

THURBER ENGINEERING LTD. CYCLIC COMPRESSION TEST REPORT

CIMA+
FILE NUMBER : 30442

REPORT DATE: April 29/21
REPORT NUMBER: CC21-3

Terwillegar Drive Stage II

TEST DATE: April 28/21
SAMPLE: TH21-12 @ 8.44 - 8.58 m
DESCRIPTION: Sandstone (SC), fine to med. grain, silty, slightly bentonitic, trace coal stringers, light grey.

SPECIMEN DETAILS:

Wet Density (kg/m³): 2236
Dry Density (kg/m³): 1986
Water Content (%): 12.6

Liquid Limit (%):
Plastic Limit (%):
Plasticity Index (%):

Gravel (%):
Sand (%):
Silt (%):
Clay (%):

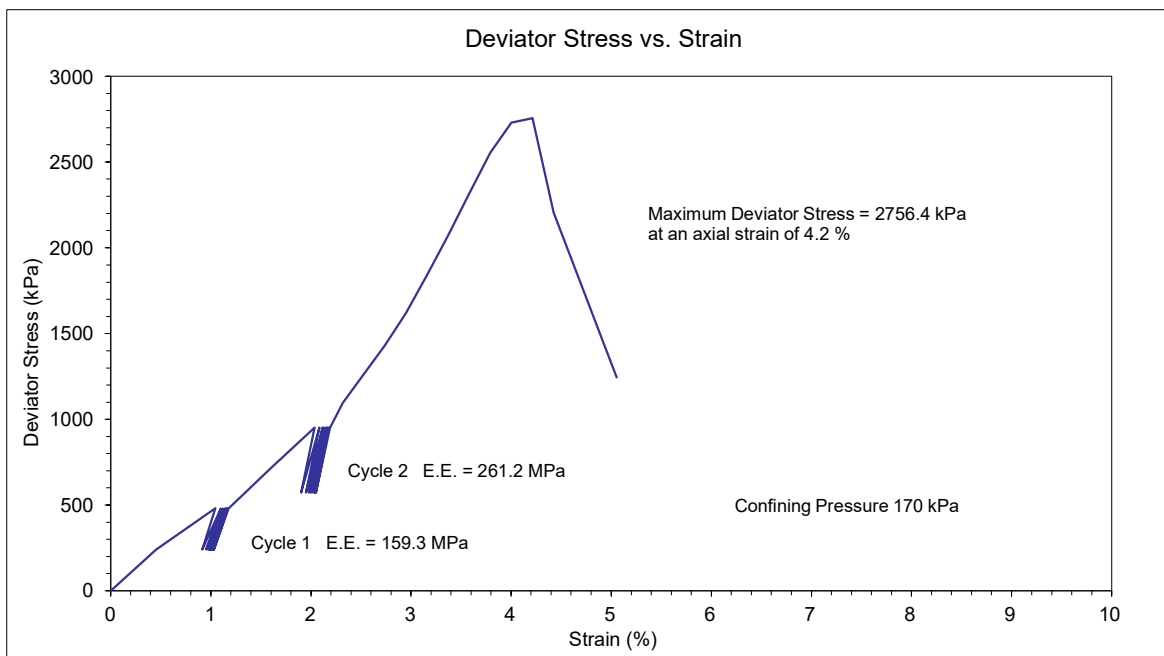

THURBER ENGINEERING LTD. CYCLIC COMPRESSION TEST REPORT

CIMA+
FILE NUMBER : 30442

REPORT DATE: April 29/21
REPORT NUMBER: CC21-4

Terwillegar Drive Stage II

TEST DATE: April 28/21
SAMPLE: TH21-12 @ 10.70 - 10.90 m
DESCRIPTION: Clay Shale (CH), silty, trace thin siltstone lenses, grey.

SPECIMEN DETAILS:

Wet Density (kg/m³): 2210
Dry Density (kg/m³): 1931
Water Content (%): 14.4

Liquid Limit (%):
Plastic Limit (%):
Plasticity Index (%):

Gravel (%):
Sand (%):
Silt (%):
Clay (%):

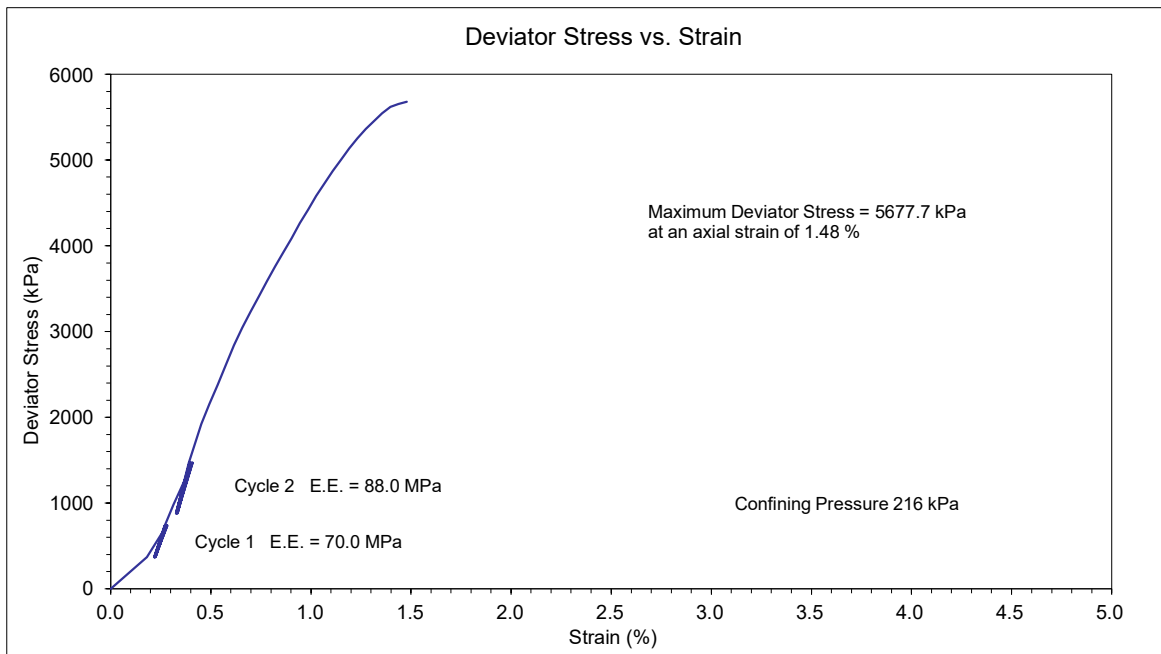

CONSOLIDATED UNDRAINED TRIAXIAL TEST REPORT

CU21-1a @ 100 kPa from TH21-5 @ 8.38 - 8.84 m

CU21-1b @ 150 kPa from TH21-5 @ 8.38 - 8.84 m

CU21-1c @ 200 kPa from TH21-6 @ 8.38 - 8.84 m

Client: CIMA+
Project: Terwillergar Drive Stage II - Preliminary Design

Report Date: April 30/21
File Number: 30442

Index Testing Data

	100 kPa	150 kPa	200 kPa
Liquid Limit (%):	70	70	60
Plastic Limit (%):	27	27	24
Plasticity Index (%)	43	43	36
Sand (%):	-	-	-
Silt (%):	-	-	-
Clay (%):	-	-	-

Clay (CH) silty, trace silt lenses, coal, oxides, brown and grey.

Specimen Data

	100 kPa		150 kPa		200 kPa	
	As Set Up / As Tested	As Set Up / As Tested	As Set Up / As Tested	As Set Up / As Tested	As Set Up / As Tested	As Set Up / As Tested
Wet Density (kg/m ³):	1916	1905	1904	1910	1973	1995
Dry Density (kg/m ³):	1441	1425	1424	1433	1541	1551
Water Content (%):	33.0	33.7	33.7	33.3	28.0	28.6
Void Ratio:	0.91	0.93	0.93	0.92	0.80	0.79
Saturation (%):	100	100	100	100	97	100
Pore Press. Parameter B:	0.59	0.95	0.97	0.97	0.42	0.95

Stress/Strain Data

	At Maximum		At Maximum		At Maximum	
	Deviator	Stress Ratio	Deviator	Stress Ratio	Deviator	Stress Ratio
Axial Strain (%):	2.60	2.75	2.06	1.99	5.11	4.12
Stress Ratio:	2.67	2.67	2.42	2.42	2.31	2.31
Deviator Stress (kPa):	120.0	121.7	142.2	142.1	164.9	161.0
Chg. in Pore Press. (kPa):	28.5	27.3	48.6	49.0	74.1	76.5
Eff. Conf. Pressure (kPa):	71.8	72.9	100.2	99.9	125.9	123.1
Pore Press. Parameter A:	0.238	0.224	0.342	0.345	0.449	0.475
Rate of Strain (mm/min):	0.0075	0.0075	0.0070	0.0070	0.0030	0.0030

CONSOLIDATED UNDRAINED TRIAXIAL TEST REPORT

CU16-1a @ 300 kPa from TH16-8 @ 19.25 - 19.40 m

CU16-1b @ 500 kPa from TH16-8 @ 19.40 - 19.55 m

CU16-1c @ 700 kPa from TH16-8 @ 19.56 - 19.80 m

Original Sample

Two 72mm diameter Shelby tube samples one from TH21-5 at 8.38 - 8.84 m and one from TH21-6 at 8.38 - 8.84 m in the CH Clay material.

Test Specimens

Two specimens were cut from one sample and run at 100, 150 and a third sample cut the other sample for the 200 kPa confining.

Test Apparatus

The test apparatus consisted of a triaxial pressure chamber with 72 mm diameter end platens. Porous stones and filter paper disks were placed at both ends of the specimen. Five strips of filter paper were applied to the perimeter of the specimens to act as side drains. Two latex membranes enveloped the specimens.

Test Procedure

The specimens were saturated by simultaneously increasing the cell and back pressure in 50 kPa increments until $B > 0.95$ was achieved. Then the first specimen was consolidated to the 100 kPa effective confining pressure required for the first stage of axial loading. The consolidation data was used to calculate a rate of strain that would allow for equalization of pore pressure during loading. As the axial load was applied the test was closely monitored and when the stress ratio plot indicated that the specimen was close to failure the loading was stopped. The axial load was reduced to zero and the specimen was allowed to rebound. Then the specimen was consolidated to 150 kPa followed by a second stage of axial loading. The second sample was used for the third stage of loading. After saturating the specimen it was consolidated at 200 kPa and a rate of strain was determined. The test was terminated after the load was applied and the deviator had reached a peak.

Sample: TH21-5 @ 8.38 - 8.84 m & TH21-6 @ 8.38 - 8.84 m

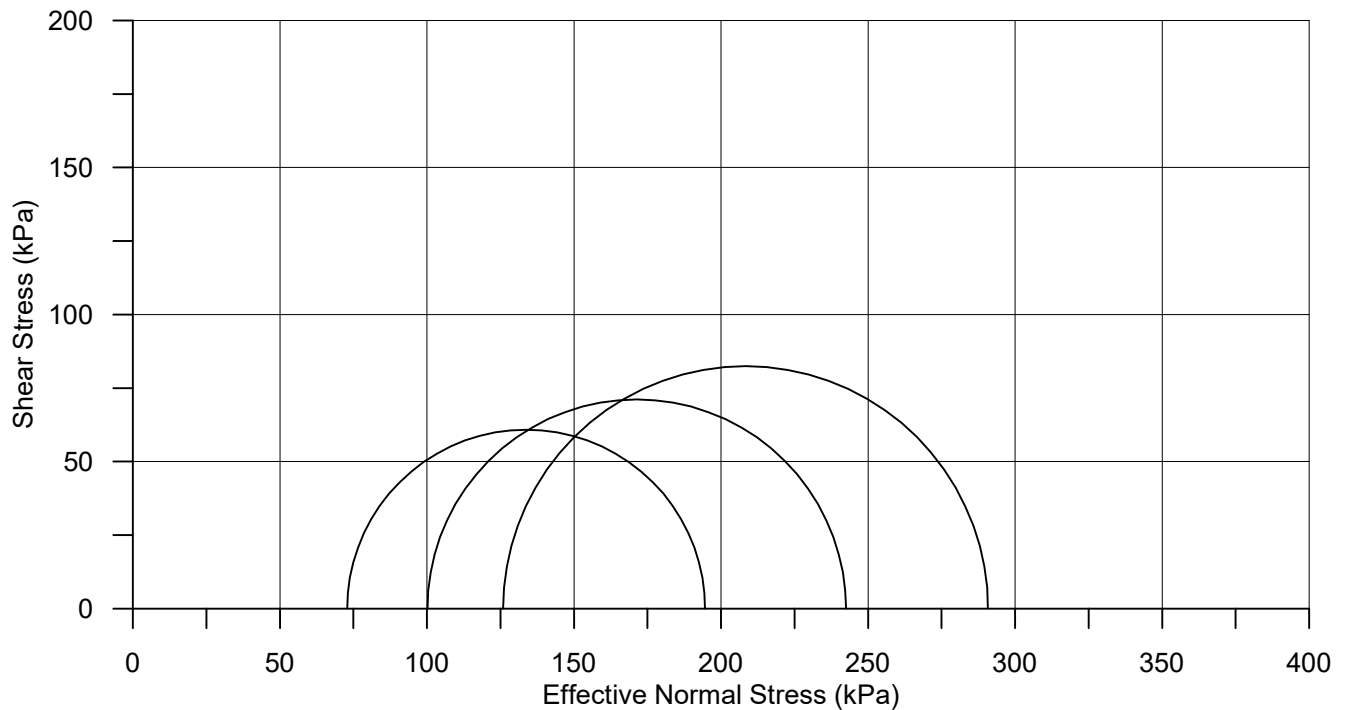
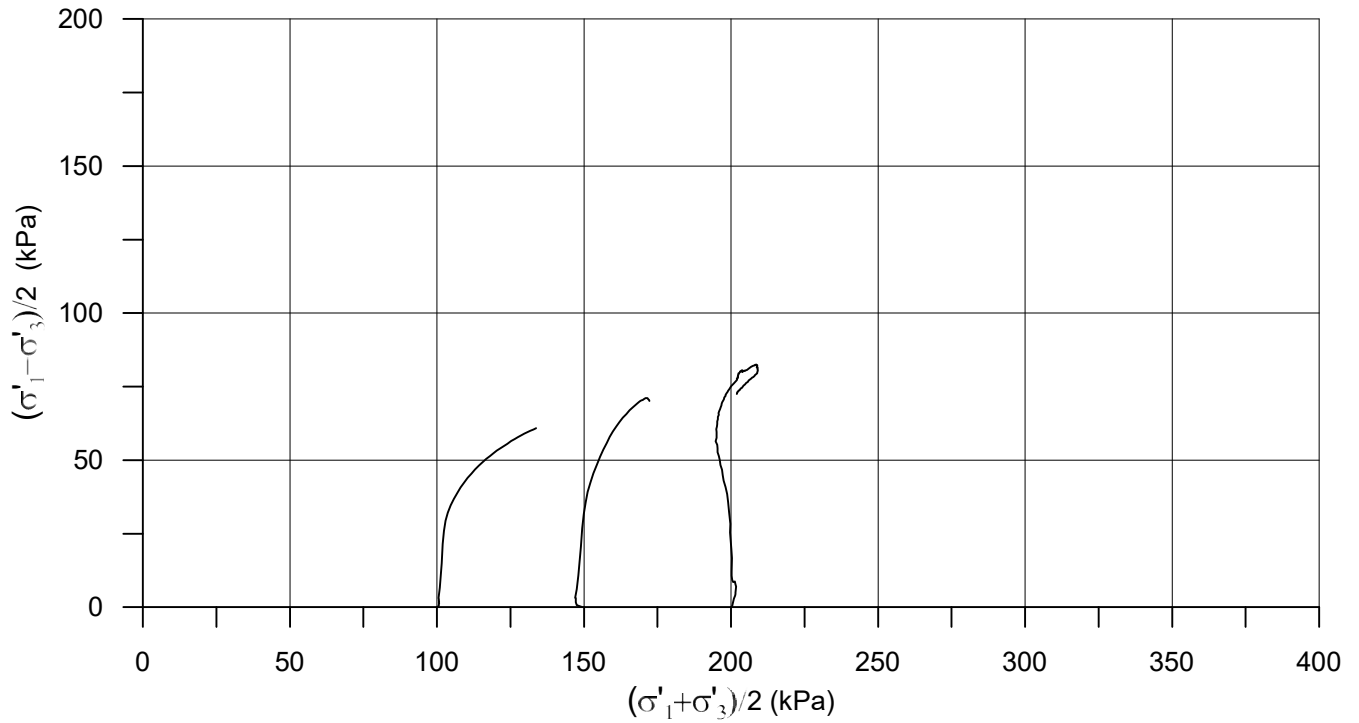

THURBER ENGINEERING LTD.

Client: CIMA+
Project: Terwilligar Drive Stage 2 Preliminary Design
File No.: 30442
Date: April 30/21

**CONSOLIDATED UNDRAINED
TRIAxIAL TEST RESULTS**

Remarks: Failure results from
maximum Deviator plot

Sample: TH21-5 @ 8.38 - 8.84 m & TH21-6 @ 8.38 - 8.84 m

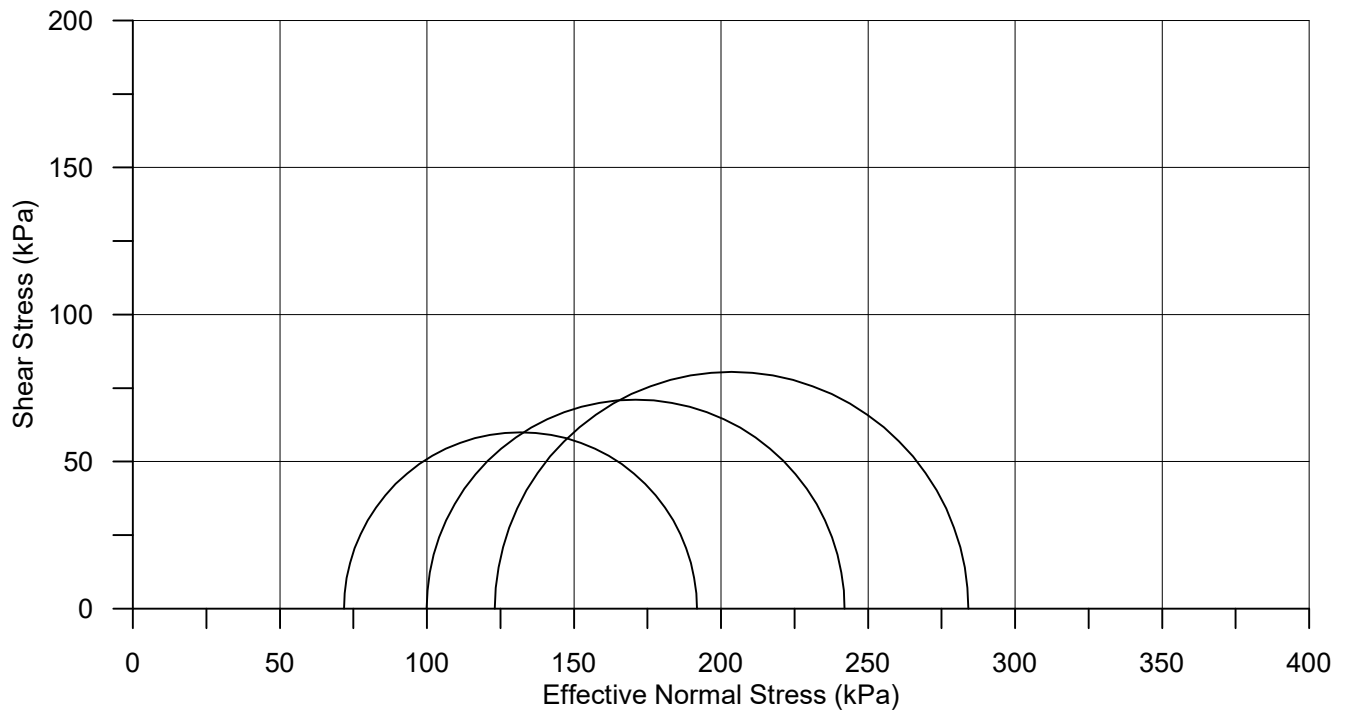
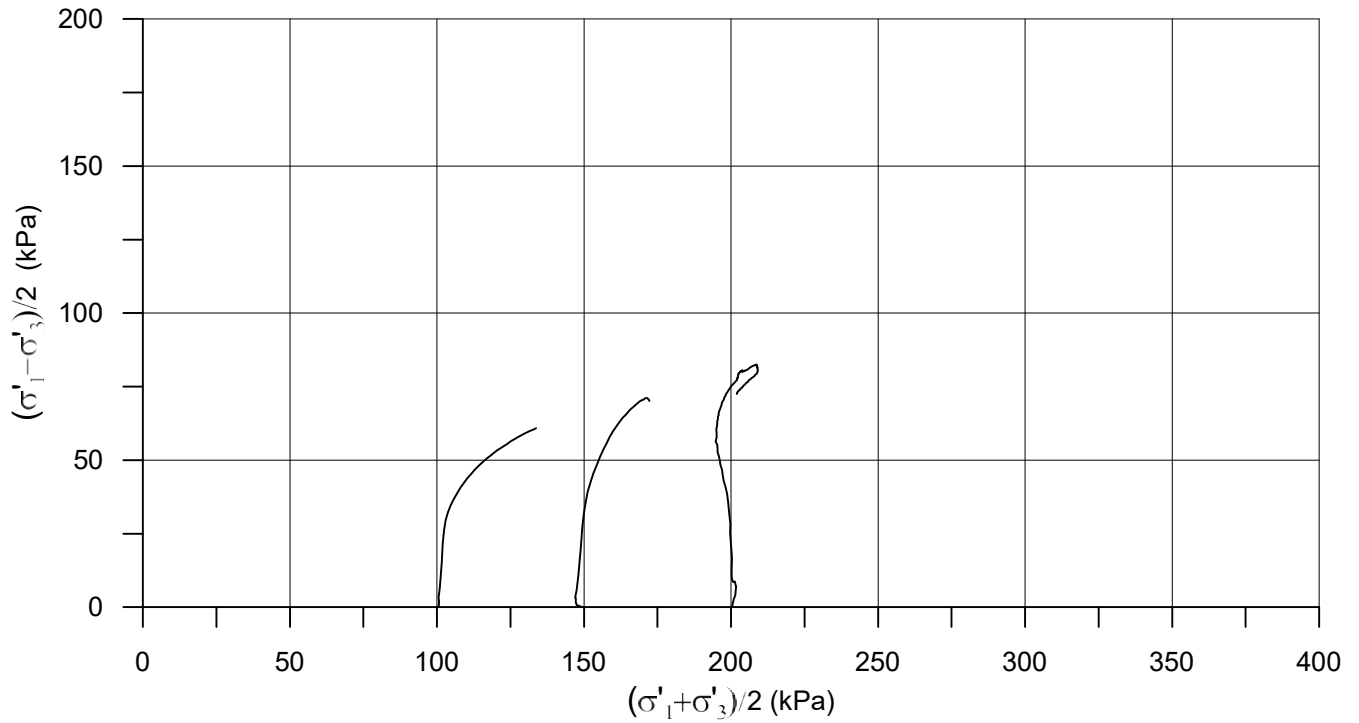

THURBER ENGINEERING LTD.

Client: CIMA+
Project: Terwilligar Drive Stage 2 Preliminary Design
File No.: 30442
Date: April 30/21

**CONSOLIDATED UNDRAINED
TRIAxIAL TEST RESULTS**

Remarks: Failure results from
maximum Stress Ratio plot

MULTISTAGE CONSOLIDATED UNDRAINED TRIAXIAL TEST REPORT

Effective Confining Pressures: 100, 150, 200 kPa
TH21-6 @ 3.81 - 4.27 m

CIMA+
Terwillegar Drive Stage 2 - Preliminary Design

Report Date: May 20/21
File Number: 30442

Index Testing Data

Liquid Limit:	69%	Gravel:	-
Plastic Limit:	27%	Sand:	-
Plasticity Index:	42%	Silt:	-
Classification:	CH	Clay:	-

Clay (CH), silty, trace silt lenses, coal, oxides, brown and grey.

Specimen Data

	As		As Tested	
	Set Up	Stage 1	Stage 2	Stage 3
Effective Confining Stress (kPa):		100	150	200
Wet Density (kg/m ³):	1942	1915	1922	1930
Dry Density (kg/m ³):	1488	1457	1468	1481
Moisture Content (%):	30.5	31.4	30.9	30.3
Void Ratio:	0.84	0.88	0.87	0.85
Saturation (%):	99	98	98	98
Pore Press. Parameter B:	0.54	0.95	0.97	0.96

Stress/Strain Data

	Stage 1 at 80 kPa		Stage 2 at 150 kPa		Stage 3 at 250 kPa	
	Max.	Max.	Max.	Max.	Max.	Max.
	Stress Ratio	Deviator	Stress Ratio	Deviator	Stress Ratio	Deviator
Axial Strain (%):	1.85	1.85	2.25	2.25	2.31	3.41
Stress Ratio:	2.71	2.71	2.45	2.45	2.33	2.28
Deviator Stress (kPa):	113.9	113.9	144.1	144.1	177	180
Change in Pore Pressure (kPa):	34	34	50.1	50.1	66	58
Effective Confining Pressure (kPa):	66.6	66.6	99.7	99.7	133	141
Pore Pressure Parameter A:	0.30	0.30	0.35	0.35	0.37	0.32
Rate of Displacement (%/min):	0.003	0.003	0.002	0.002	0.002	0.002

MULTISTAGE CONSOLIDATED UNDRAINED TRIAXIAL TEST REPORT

Effective Confining Pressures: 100, 150, 200 kPa

TH21-6 @ 3.81 - 4.27 m

Original Sample

The original sample was an undisturbed Shelby tube sample. It was 72 mm in diameter and 330 mm long.

Test Specimen

The test specimen was taken between 150 and 300 mm from the top of the Shelby tube sample. It was 72 mm in diameter and 151 mm long. Sample trimmings were used for Index testing.

Test Apparatus

The test apparatus consisted of a plastic triaxial chamber equipped with 72 mm diameter platens. Porous stone and filter paper disks were placed at the top and bottom of the specimen. Filter paper strips were placed as side drains around the perimeter of the specimen. A single latex rubber membrane was used to envelope the specimen.

Test Procedure

The initial pore pressure response indicated that the specimen was not saturated ($B=.54$), The specimen was saturated by simultaneously increasing the cell and back pressure in 50 kPa increments until $B>.95$ was achieved. Then the specimen was consolidated to the effective confining pressure required for the first stage of axial loading. The consolidation data was used to calculate a rate of strain that would allow for equalization of pore pressure during loading.

As the axial load was applied the test was closely monitored and when the stress ratio plot indicated that the specimen was close to failure the loading was stopped. The axial load was reduced to zero and the specimen was allowed to rebound. Then the specimen was consolidated to 150 kPa followed by a second stage of axial loading and rebounding similar to the first stage. Finally the specimen was consolidated to 200 kPa for the third and final stage of loading.

After Test

At the end of the test the specimen had failed along a primary shear plane at approx. 50° , there was also other minor secondary shear planes.

The entire specimen was used for final moisture and total dry weight mass.

Sample: TH21-6 @ 3.81 - 4.27 m

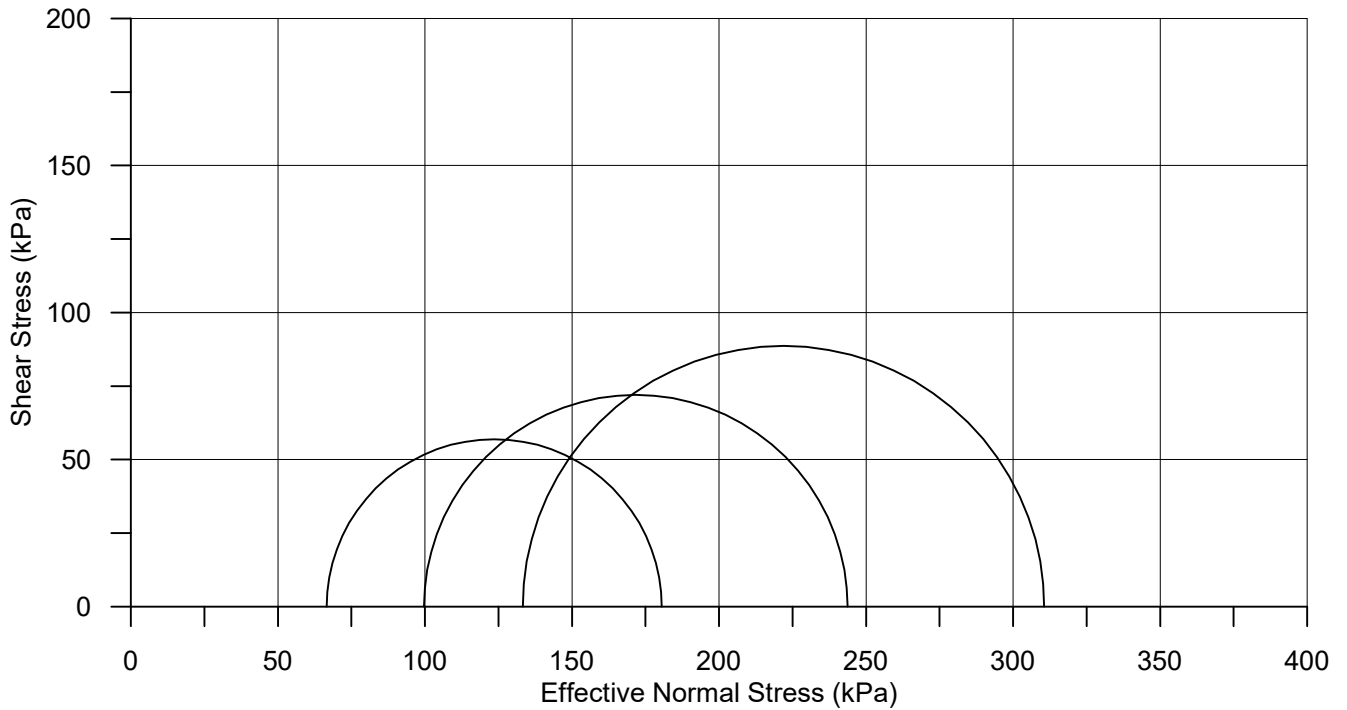
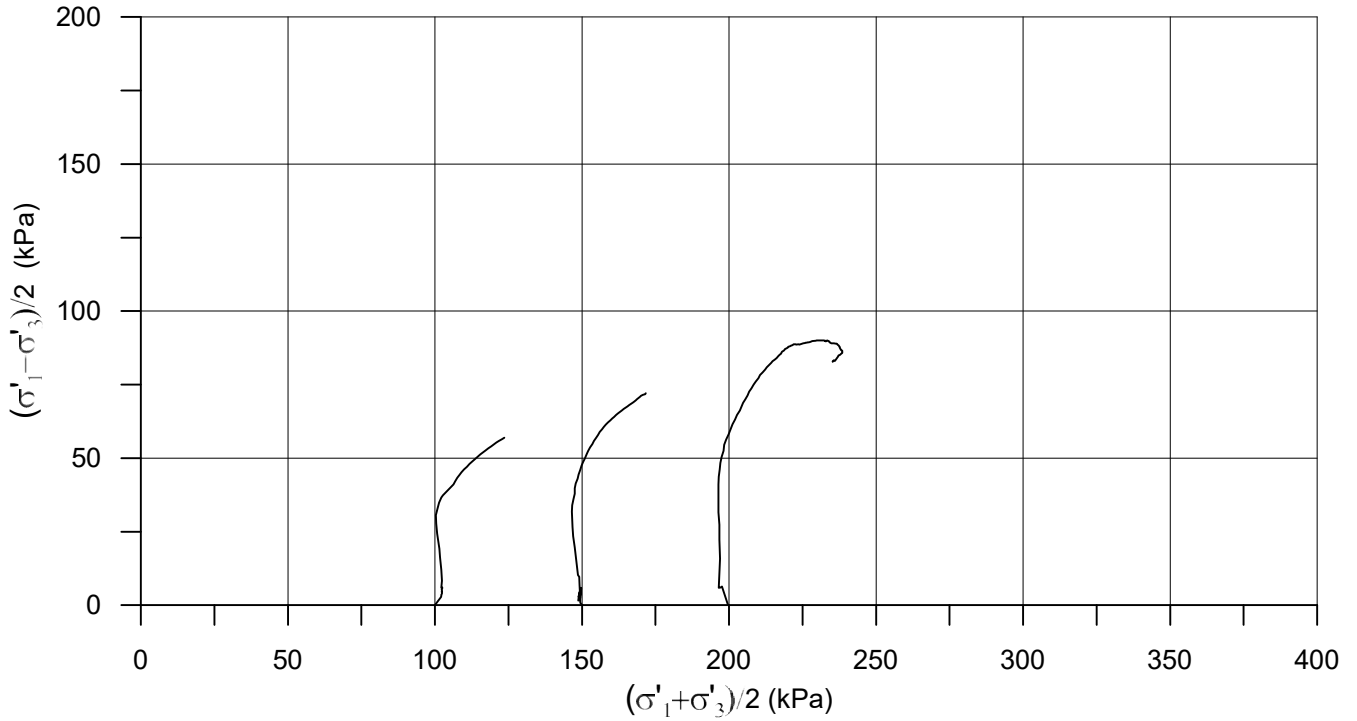

THURBER ENGINEERING LTD.

Client: CIMA+
Project: Terwilligar Drive Stage 2 Preliminary Design
File No.: 30442
Date: May 20/21

**CONSOLIDATED UNDRAINED
TRIAxIAL TEST RESULTS**

Remarks: Failure results from
maximum Stress Ratio plot

Sample: TH21-6 @ 3.81 - 4.27 m

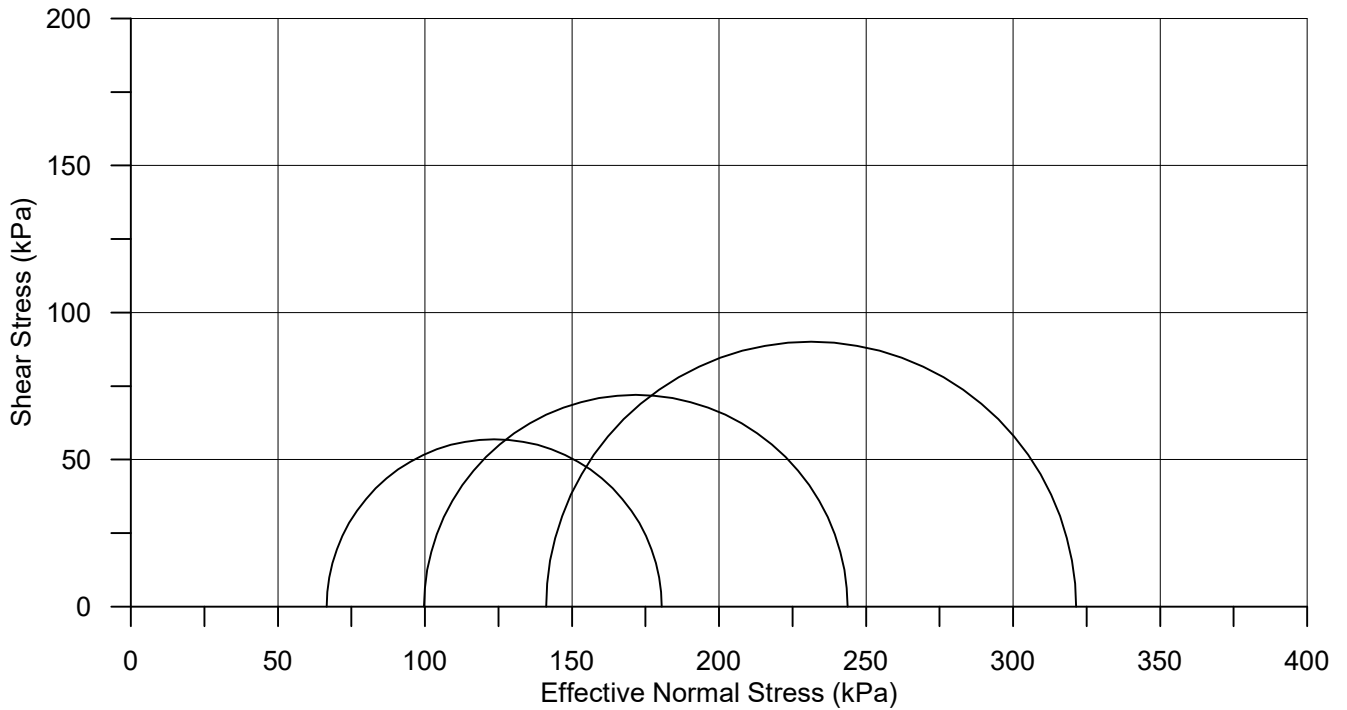
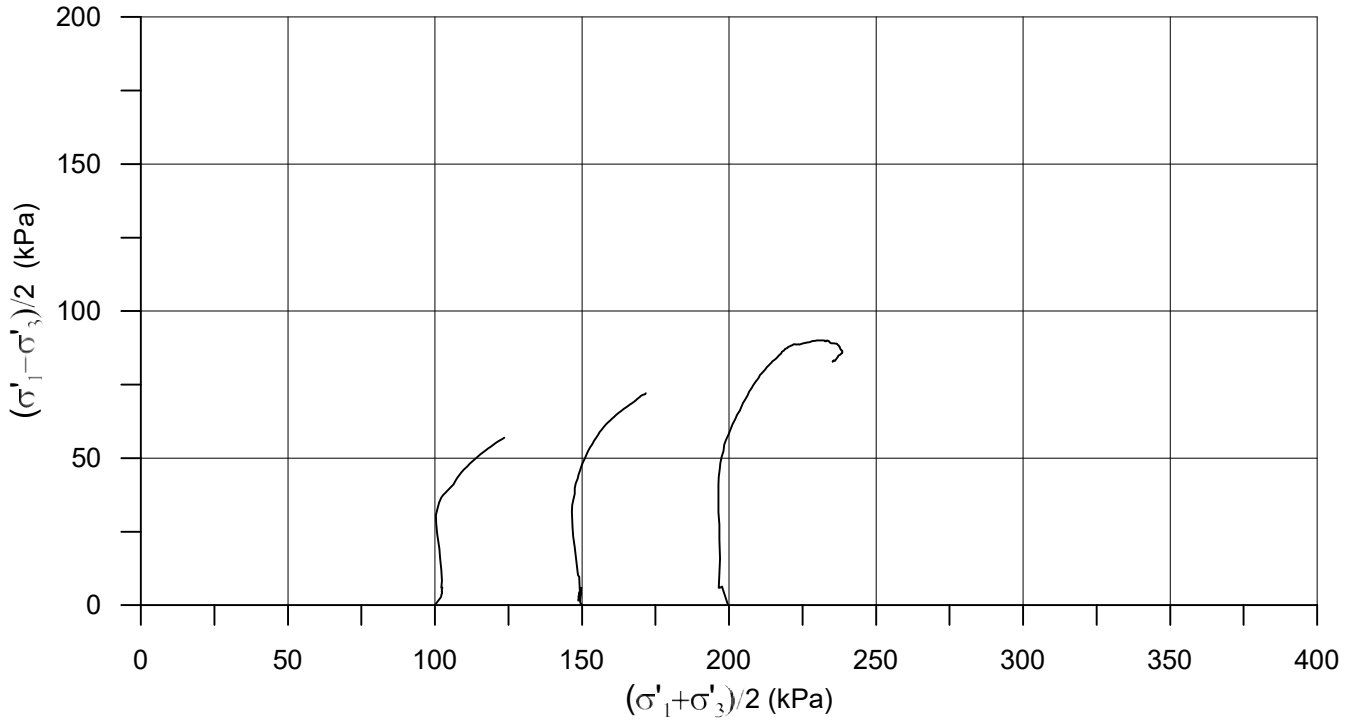

THURBER ENGINEERING LTD.

Client: CIMA+
Project: Terwilligar Drive Stage 2 Preliminary Design
File No.: 30442
Date: May 20/21

**CONSOLIDATED UNDRAINED
TRIAxIAL TEST RESULTS**

Remarks: Failure results from
maximum Deviator plot



Hydraulic Conductivity

ASTM D5084, Method A (Constant Head)

Client: CIMA+

Date: 04-May-21

Project: Terwillegar Drive Stage 2 - Preliminary Design and Delivery

File No.: 30442

Sample Information

Location: TH21-6
 Elevation: 2.29 - 2.74 m
 Type: Undisturbed, Shelby Tube
 Soil Type: Clay (Cl), sandy, silty, trace CH clay, sand pockets, organics, slaystone pockets, coal, oxides, gravel, brown
 Lab Series na

Test Results

Coefficient of Permeability: 5.1E-11 m/s
 Ave Effective Confining Stres 14 kPa
 Ave. Hydraulic Gradient: 20
 Permeate Liquid: Distilled Water
 Comments:

	As Set Up	Final
Height:	4.94 cm	5.03 cm
Diameter:	7.23 cm	7.33 cm
Dry Density:	1893 kg/m ³	1812 kg/m ³
Water Conte	11.2 %	16.5 %
Saturation:	77 %	98 %

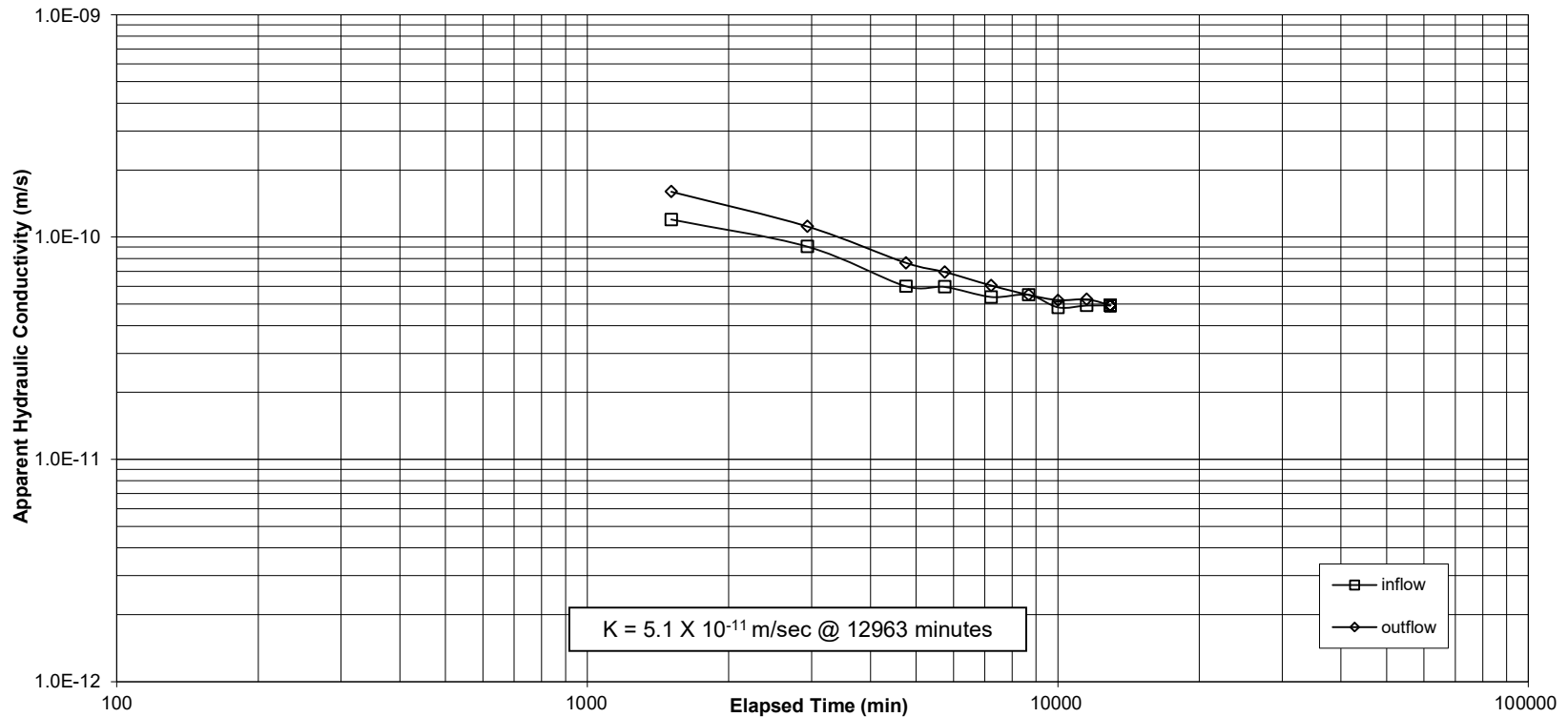



Hydraulic Conductivity

ASTM D5084, Method A (Constant Head)

Client: CIMA+

Date: 02-May-21

Project: Terwillegar Drive Stage 2 - Preliminary Design and Delivery

File No.: 30442

Sample Information

Location: TH21-6
 Elevation: 5.33 - 5.79 m
 Type: Undisturbed, Shelby Tube
 Soil Type: Clay (CH), silty, trace silt lenses, brown and grey
 Lab Series na

Test Results

Coefficient of Permeability: 5.1E-11 m/s
 Ave Effective Confining Stres 16 kPa
 Ave. Hydraulic Gradient: 24
 Permeate Liquid: Distilled Water
 Comments:

	As Set Up	Final
Height:	4.94 cm	5.11 cm
Diameter:	7.23 cm	7.35 cm
Dry Density:	1479 kg/m ³	1384 kg/m ³
Water Conte	30.8 %	36.0 %
Saturation:	99 %	100 %

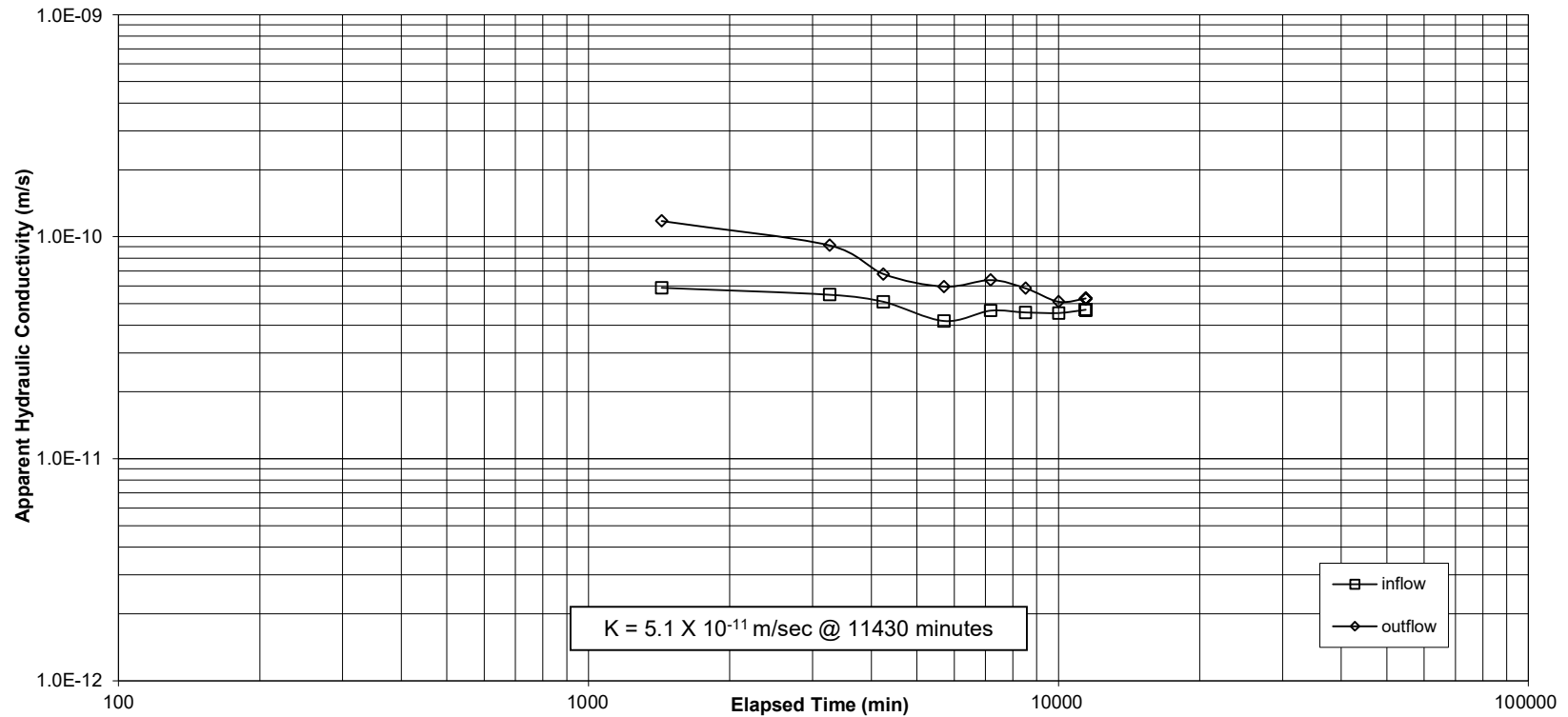



THURBER ENGINEERING LTD.

4127 Roper Road
Edmonton, Alberta T6B 3S5
Phone (780) 438-1460 | Fax (780) 437-7125

Job No:	30442		
Client:	CIMA+		
Project:	Terwillegar Drive Stage Two		
HOLE/PIT:	TH21-3	SAMPLE:	B3
DEPTH:	1.52 m	TECH:	NM
DATE:	27-Apr-21	CHECKED BY:	

SULPHATE TEST ON SOILS USING PFRA METHOD

BEAKER NO: 30 / D9 CRUCIBLE NO: 21-1

- 1- Add 100 g of oven dried soil, passing No. 40 sieve.
- 2- Add 500 mL of distilled water - or ratio of 20 g of soil to 100 g of water.
- 3- Add 3 drops of concentrated HCL acid.
- 4- Place mixture in oven (110C, 250F) for 1 hour or allow to sit overnight.
- 5- Draw off or filter 100 mL clear liquid from mixture into 250 mL beaker.
- 6- Add 100 mL distilled water on 5 mL concentrated HCL acid.
- 7- Heat in oven for 1 hour.
- 8- Add 10 mL of 10% BACL2 solution, mix thoroughly, observe reaction.

<input type="checkbox"/>	Clear Solution No Reaction	<input checked="" type="checkbox"/>	Slightly Milky No Precipitate	<input type="checkbox"/>	Milky Solution With Precipitate
--------------------------	-------------------------------	-------------------------------------	----------------------------------	--------------------------	------------------------------------

- 9- Filter mixture through crucible on vacuum setup, dry crucible thoroughly in oven

Wt of Crucible + BaSO4 (ppt) (oven dried)	<u>26.11</u> g
WTt of Crucible Empty	<u>26.09</u> g
Wt of BaSO4 (ppt)	<u>0.02</u> g
Wt of Soil Used (passing No. 40 sieve)	<u>100</u> g

CALCULATIONS

Gravimetric Factor

$$\text{Wt of Sulphate} = \frac{\text{Wt BaSO}_4 \text{ (ppt) gms}}{\text{Gravimetric Factor}} = \frac{0.02}{2.60} = 0.008 \text{ g}$$

$$\text{Percent Sulphate} = \frac{\text{Wt of SO}_4 \times 100\%}{\text{Wt of Soil Used (g)}} = \frac{0.77}{20} = 0.04 \%$$

<input checked="" type="checkbox"/>	0-0.1%	Clear Solution, No reaction
<input type="checkbox"/>	0.1-0.5%	Slightly Milky, No Precipitation Dangerous if Water Table is Too High
<input type="checkbox"/>	>0.5%	Milky with Precipitate Dangerous, use HS Cement



THURBER ENGINEERING LTD.

4127 Roper Road
Edmonton, Alberta T6B 3S5
Phone (780) 438-1460 | Fax (780) 437-7125

Job No:	30442		
Client:	CIMA+		
Project:	Terwillegar Drive Stage Two		
HOLE/PIT:	TH21-5	SAMPLE:	B5
DEPTH:	3.51 m	TECH:	NM
DATE:	27-Apr-21	CHECKED BY:	

SULPHATE TEST ON SOILS USING PFRA METHOD

BEAKER NO: 11-13 / D5 CRUCIBLE NO: 21-4

- 1- Add 100 g of oven dried soil, passing No. 40 sieve.
- 2- Add 500 mL of distilled water - or ratio of 20 g of soil to 100 g of water.
- 3- Add 3 drops of concentrated HCL acid.
- 4- Place mixture in oven (110C, 250F) for 1 hour or allow to sit overnight.
- 5- Draw off or filter 100 mL clear liquid from mixture into 250 mL beaker.
- 6- Add 100 mL distilled water on 5 mL concentrated HCL acid.
- 7- Heat in oven for 1 hour.
- 8- Add 10 mL of 10% BACL2 solution, mix thoroughly, observe reaction.

<input type="checkbox"/>	Clear Solution No Reaction	<input checked="" type="checkbox"/>	Slightly Milky No Precipitate	<input type="checkbox"/>	Milky Solution With Precipitate
--------------------------	-------------------------------	-------------------------------------	----------------------------------	--------------------------	------------------------------------

- 9- Filter mixture through crucible on vacuum setup, dry crucible thoroughly in oven

Wt of Crucible + BaSO4 (ppt) (oven dried)	<u>25.67</u> g
WTt of Crucible Empty	<u>25.66</u> g
Wt of BaSO4 (ppt)	<u>0.01</u> g
Wt of Soil Used (passing No. 40 sieve)	<u>100.02</u> g

CALCULATIONS

Gravimetric Factor

$$\text{Wt of Sulphate} = \frac{\text{Wt BaSO}_4 \text{ (ppt) gms}}{\text{Gravimetric Factor}} = \frac{0.01}{2.60} = 0.004 \text{ g}$$

$$\text{Percent Sulphate} = \frac{\text{Wt of SO}_4 \times 100\%}{\text{Wt of Soil Used (g)}} = \frac{0.38}{20.004} = 0.02 \%$$

<input checked="" type="checkbox"/>	0-0.1%	Clear Solution, No reaction
<input type="checkbox"/>	0.1-0.5%	Slightly Milky, No Precipitation Dangerous if Water Table is Too High
<input type="checkbox"/>	>0.5%	Milky with Precipitate Dangerous, use HS Cement



THURBER ENGINEERING LTD.

4127 Roper Road
Edmonton, Alberta T6B 3S5
Phone (780) 438-1460 | Fax (780) 437-7125

Job No:	30442		
Client:	CIMA+		
Project:	Terwillegar Drive Stage Two		
HOLE/PIT:	TH21-5	SAMPLE:	B23
DEPTH:	13.72 m	TECH:	NM
DATE:	27-Apr-21	CHECKED BY:	

SULPHATE TEST ON SOILS USING PFRA METHOD

BEAKER NO: R6 / 1 CRUCIBLE NO: 21-2

- 1- Add 100 g of oven dried soil, passing No. 40 sieve.
- 2- Add 500 mL of distilled water - or ratio of 20 g of soil to 100 g of water.
- 3- Add 3 drops of concentrated HCL acid.
- 4- Place mixture in oven (110C, 250F) for 1 hour or allow to sit overnight.
- 5- Draw off or filter 100 mL clear liquid from mixture into 250 mL beaker.
- 6- Add 100 mL distilled water on 5 mL concentrated HCL acid.
- 7- Heat in oven for 1 hour.
- 8- Add 10 mL of 10% BACL2 solution, mix thoroughly, observe reaction.

<input type="checkbox"/>	Clear Solution No Reaction	<input checked="" type="checkbox"/>	Slightly Milky No Precipitate	<input type="checkbox"/>	Milky Solution With Precipitate
--------------------------	-------------------------------	-------------------------------------	----------------------------------	--------------------------	------------------------------------

- 9- Filter mixture through crucible on vacuum setup, dry crucible thoroughly in oven

Wt of Crucible + BaSO4 (ppt) (oven dried)	<u>25.76</u> g
WTt of Crucible Empty	<u>25.75</u> g
Wt of BaSO4 (ppt)	<u>0.01</u> g
Wt of Soil Used (passing No. 40 sieve)	<u>100</u> g

CALCULATIONS

Gravimetric Factor

$$\text{Wt of Sulphate} = \frac{\text{Wt BaSO}_4 \text{ (ppt) gms}}{\text{Gravimetric Factor}} = \frac{0.01}{2.60} = 0.004 \text{ g}$$

$$\text{Percent Sulphate} = \frac{\text{Wt of SO}_4 \times 100\%}{\text{Wt of Soil Used (g)}} = \frac{0.38}{20} = 0.02 \%$$

<input checked="" type="checkbox"/>	0-0.1%	Clear Solution, No reaction
<input type="checkbox"/>	0.1-0.5%	Slightly Milky, No Precipitation Dangerous if Water Table is Too High
<input type="checkbox"/>	>0.5%	Milky with Precipitate Dangerous, use HS Cement



4127 Roper Road
 Edmonton, Alberta T6B 3S5
 Phone (780) 438-1460 | Fax (780) 437-7125

Job No:	30442		
Client:	CIMA+		
Project:	Terwillegar Drive Stage Two		
HOLE/PIT:	TH21-7	SAMPLE:	B6
DEPTH:	3.51 m	TECH:	NM
DATE:	27-Apr-21	CHECKED BY:	

SULPHATE TEST ON SOILS USING PFRA METHOD

BEAKER NO: R8 / 6 CRUCIBLE NO: 21-3

- 1- Add 100 g of oven dried soil, passing No. 40 sieve.
- 2- Add 500 mL of distilled water - or ratio of 20 g of soil to 100 g of water.
- 3- Add 3 drops of concentrated HCL acid.
- 4- Place mixture in oven (110C, 250F) for 1 hour or allow to sit overnight.
- 5- Draw off or filter 100 mL clear liquid from mixture into 250 mL beaker.
- 6- Add 100 mL distilled water on 5 mL concentrated HCL acid.
- 7- Heat in oven for 1 hour.
- 8- Add 10 mL of 10% BACL2 solution, mix thoroughly, observe reaction.

	Clear Solution No Reaction	X	Slightly Milky No Precipitate		Milky Solution With Precipitate
--	-------------------------------	---	----------------------------------	--	------------------------------------

- 9- Filter mixture through crucible on vacuum setup, dry crucible thoroughly in oven

Wt of Crucible + BaSO4 (ppt) (oven dried)	<u>26.23</u> g
WTt of Crucible Empty	<u>26.22</u> g
Wt of BaSO4 (ppt)	<u>0.01</u> g
Wt of Soil Used (passing No. 40 sieve)	<u>100.01</u> g

CALCULATIONS

Gravimetric Factor

$$\text{Wt of Sulphate} = \frac{\text{Wt BaSO}_4 \text{ (ppt) gms}}{\text{Gravimetric Factor}} = \frac{0.01}{2.60} = 0.004 \text{ g}$$

$$\text{Percent Sulphate} = \frac{\text{Wt of SO}_4 \times 100\%}{\text{Wt of Soil Used (g)}} = \frac{0.38}{20.002} = 0.02 \%$$

X	0-0.1%	Clear Solution, No reaction
	0.1-0.5%	Slightly Milky, No Precipitation Dangerous if Water Table is Too High
	>0.5%	Milky with Precipitate Dangerous, use HS Cement



THURBER ENGINEERING LTD.

4127 Roper Road
Edmonton, Alberta T6B 3S5
Phone (780) 438-1460 | Fax (780) 437-7125

Job No:	30442		
Client:	CIMA+		
Project:	Terwillegar Drive Stage Two		
HOLE/PIT:	TH21-8	SAMPLE:	P9
DEPTH:	5.33 - 5.79 m	TECH:	JAP
DATE:	26-Apr-21	CHECKED BY:	

SULPHATE TEST ON SOILS USING PFRA METHOD

BEAKER NO: B2/17 CRUCIBLE NO: 17-8

- 1- Add 100 g of oven dried soil, passing No. 40 sieve.
- 2- Add 500 mL of distilled water - or ratio of 20 g of soil to 100 g of water.
- 3- Add 3 drops of concentrated HCL acid.
- 4- Place mixture in oven (110C, 250F) for 1 hour or allow to sit overnight.
- 5- Draw off or filter 100 mL clear liquid from mixture into 250 mL beaker.
- 6- Add 100 mL distilled water on 5 mL concentrated HCL acid.
- 7- Heat in oven for 1 hour.
- 8- Add 10 mL of 10% BACL2 solution, mix thoroughly, observe reaction.

<input type="checkbox"/>	Clear Solution No Reaction	<input checked="" type="checkbox"/>	Slightly Milky No Precipitate	<input type="checkbox"/>	Milky Solution With Precipitate
--------------------------	-------------------------------	-------------------------------------	----------------------------------	--------------------------	------------------------------------

- 9- Filter mixture through crucible on vacuum setup, dry crucible thoroughly in oven

Wt of Crucible + BaSO4 (ppt) (oven dried)	<u>25.61</u> g
WTt of Crucible Empty	<u>25.6</u> g
Wt of BaSO4 (ppt)	<u>0.01</u> g
Wt of Soil Used (passing No. 40 sieve)	<u>100.02</u> g

CALCULATIONS

Gravimetric Factor

$$\text{Wt of Sulphate} = \frac{\text{Wt BaSO}_4 \text{ (ppt) gms}}{\text{Gravimetric Factor}} = \frac{0.01}{2.60} = 0.004 \text{ g}$$

$$\text{Percent Sulphate} = \frac{\text{Wt of SO}_4 \times 100\%}{\text{Wt of Soil Used (g)}} = \frac{0.38}{20.004} = 0.02 \%$$

<input checked="" type="checkbox"/>	0-0.1%	Clear Solution, No reaction
<input type="checkbox"/>	0.1-0.5%	Slightly Milky, No Precipitation Dangerous if Water Table is Too High
<input type="checkbox"/>	>0.5%	Milky with Precipitate Dangerous, use HS Cement



THURBER ENGINEERING LTD.

4127 Roper Road
Edmonton, Alberta T6B 3S5
Phone (780) 438-1460 | Fax (780) 437-7125

Job No:	30442		
Client:	CIMA+		
Project:	Terwillegar Drive Stage Two		
HOLE/PIT:	TH21-9	SAMPLE:	P6
DEPTH:	3.81 - 4.27 m	TECH:	JAP
DATE:	26-Apr-21	CHECKED BY:	

SULPHATE TEST ON SOILS USING PFRA METHOD

BEAKER NO: 5/D4 CRUCIBLE NO: A4

- 1- Add 100 g of oven dried soil, passing No. 40 sieve.
- 2- Add 500 mL of distilled water - or ratio of 20 g of soil to 100 g of water.
- 3- Add 3 drops of concentrated HCL acid.
- 4- Place mixture in oven (110C, 250F) for 1 hour or allow to sit overnight.
- 5- Draw off or filter 100 mL clear liquid from mixture into 250 mL beaker.
- 6- Add 100 mL distilled water on 5 mL concentrated HCL acid.
- 7- Heat in oven for 1 hour.
- 8- Add 10 mL of 10% BACL2 solution, mix thoroughly, observe reaction.

<input type="checkbox"/>	Clear Solution No Reaction	<input checked="" type="checkbox"/>	Slightly Milky No Precipitate	<input type="checkbox"/>	Milky Solution With Precipitate
--------------------------	-------------------------------	-------------------------------------	----------------------------------	--------------------------	------------------------------------

- 9- Filter mixture through crucible on vacuum setup, dry crucible thoroughly in oven

Wt of Crucible + BaSO4 (ppt) (oven dried)	<u>25.6</u> g
WTt of Crucible Empty	<u>25.59</u> g
Wt of BaSO4 (ppt)	<u>0.01</u> g
Wt of Soil Used (passing No. 40 sieve)	<u>100.09</u> g

CALCULATIONS

Gravimetric Factor

$$\text{Wt of Sulphate} = \frac{\text{Wt BaSO}_4 \text{ (ppt) gms}}{\text{Gravimetric Factor}} = \frac{0.01}{2.60} = 0.004 \text{ g}$$

$$\text{Percent Sulphate} = \frac{\text{Wt of SO}_4 \times 100\%}{\text{Wt of Soil Used (g)}} = \frac{0.38}{20.018} = 0.02 \%$$

<input checked="" type="checkbox"/>	0-0.1%	Clear Solution, No reaction
<input type="checkbox"/>	0.1-0.5%	Slightly Milky, No Precipitation Dangerous if Water Table is Too High
<input type="checkbox"/>	>0.5%	Milky with Precipitate Dangerous, use HS Cement



THURBER ENGINEERING LTD.

4127 Roper Road
Edmonton, Alberta T6B 3S5
Phone (780) 438-1460 | Fax (780) 437-7125

Job No:	30442		
Client:	CIMA+		
Project:	Terwillegar Drive Stage Two		
HOLE/PIT:	TH21-11	SAMPLE:	B6
DEPTH:	3.51 m	TECH:	JAP
DATE:	26-Apr-21	CHECKED BY:	

SULPHATE TEST ON SOILS USING PFRA METHOD

BEAKER NO: H11/5 CRUCIBLE NO: 17-7

- 1- Add 100 g of oven dried soil, passing No. 40 sieve.
- 2- Add 500 mL of distilled water - or ratio of 20 g of soil to 100 g of water.
- 3- Add 3 drops of concentrated HCL acid.
- 4- Place mixture in oven (110C, 250F) for 1 hour or allow to sit overnight.
- 5- Draw off or filter 100 mL clear liquid from mixture into 250 mL beaker.
- 6- Add 100 mL distilled water on 5 mL concentrated HCL acid.
- 7- Heat in oven for 1 hour.
- 8- Add 10 mL of 10% BACL2 solution, mix thoroughly, observe reaction.

<input type="checkbox"/>	Clear Solution No Reaction	<input checked="" type="checkbox"/>	Slightly Milky No Precipitate	<input type="checkbox"/>	Milky Solution With Precipitate
--------------------------	-------------------------------	-------------------------------------	----------------------------------	--------------------------	------------------------------------

- 9- Filter mixture through crucible on vacuum setup, dry crucible thoroughly in oven

Wt of Crucible + BaSO4 (ppt) (oven dried)	<u>25.76</u> g
WTt of Crucible Empty	<u>25.75</u> g
Wt of BaSO4 (ppt)	<u>0.01</u> g
Wt of Soil Used (passing No. 40 sieve)	<u>100.05</u> g

CALCULATIONS

Gravimetric Factor

$$\text{Wt of Sulphate} = \frac{\text{Wt BaSO}_4 \text{ (ppt) gms}}{\text{Gravimetric Factor}} = \frac{0.01}{2.60} = 0.004 \text{ g}$$

$$\text{Percent Sulphate} = \frac{\text{Wt of SO}_4 \times 100\%}{\text{Wt of Soil Used (g)}} = \frac{0.38}{20.01} = 0.02 \%$$

<input checked="" type="checkbox"/>	0-0.1%	Clear Solution, No reaction
<input type="checkbox"/>	0.1-0.5%	Slightly Milky, No Precipitation Dangerous if Water Table is Too High
<input type="checkbox"/>	>0.5%	Milky with Precipitate Dangerous, use HS Cement



THURBER ENGINEERING LTD.

4127 Roper Road
Edmonton, Alberta T6B 3S5
Phone (780) 438-1460 | Fax (780) 437-7125

Job No:	30442		
Client:	CIMA+		
Project:	Terwillegar Drive Stage Two		
HOLE/PIT:	TH21-14	SAMPLE:	B5
DEPTH:	3.05 m	TECH:	JAP
DATE:	26-Apr-21	CHECKED BY:	

SULPHATE TEST ON SOILS USING PFRA METHOD

BEAKER NO: 32/3 CRUCIBLE NO: P12

- 1- Add 100 g of oven dried soil, passing No. 40 sieve.
- 2- Add 500 mL of distilled water - or ratio of 20 g of soil to 100 g of water.
- 3- Add 3 drops of concentrated HCL acid.
- 4- Place mixture in oven (110C, 250F) for 1 hour or allow to sit overnight.
- 5- Draw off or filter 100 mL clear liquid from mixture into 250 mL beaker.
- 6- Add 100 mL distilled water on 5 mL concentrated HCL acid.
- 7- Heat in oven for 1 hour.
- 8- Add 10 mL of 10% BACL2 solution, mix thoroughly, observe reaction.

<input type="checkbox"/>	Clear Solution No Reaction	<input checked="" type="checkbox"/>	Slightly Milky No Precipitate	<input type="checkbox"/>	Milky Solution With Precipitate
--------------------------	-------------------------------	-------------------------------------	----------------------------------	--------------------------	------------------------------------

- 9- Filter mixture through crucible on vacuum setup, dry crucible thoroughly in oven

Wt of Crucible + BaSO4 (ppt) (oven dried)	<u>25.46</u> g
WTt of Crucible Empty	<u>25.45</u> g
Wt of BaSO4 (ppt)	<u>0.01</u> g
Wt of Soil Used (passing No. 40 sieve)	<u>100.01</u> g

CALCULATIONS

Gravimetric Factor

$$\text{Wt of Sulphate} = \frac{\text{Wt BaSO}_4 \text{ (ppt) gms}}{\text{Gravimetric Factor}} = \frac{0.01}{2.60} = 0.004 \text{ g}$$

$$\text{Percent Sulphate} = \frac{\text{Wt of SO}_4 \times 100\%}{\text{Wt of Soil Used (g)}} = \frac{0.38}{20.002} = 0.02 \%$$

<input checked="" type="checkbox"/>	0-0.1%	Clear Solution, No reaction
<input type="checkbox"/>	0.1-0.5%	Slightly Milky, No Precipitation Dangerous if Water Table is Too High
<input type="checkbox"/>	>0.5%	Milky with Precipitate Dangerous, use HS Cement



APPENDIX D

Foundations Deformation Analysis Results

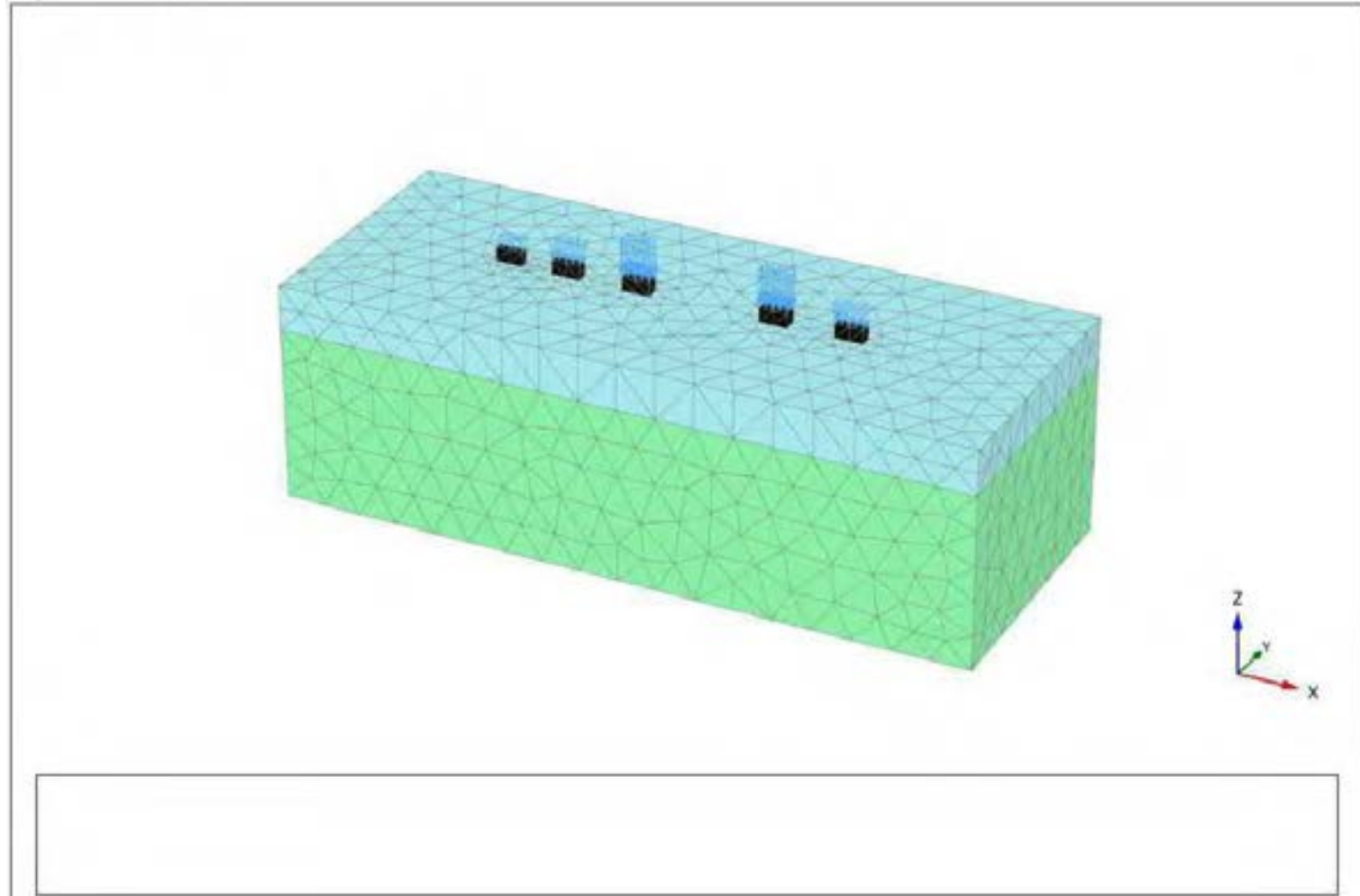

<small>Project description</small> 30442-Rainbow Valley Bridge-Pier 1	<small>Date</small> 2021-06-18
<small>Project filename</small> 30442-Rainbow Valley Bri ...	<small>Step</small> 11
<small>Company</small> Thurber Engineering Ltd	

Figure D1: Finite Element Mesh Used in the Analyses – Pier 1

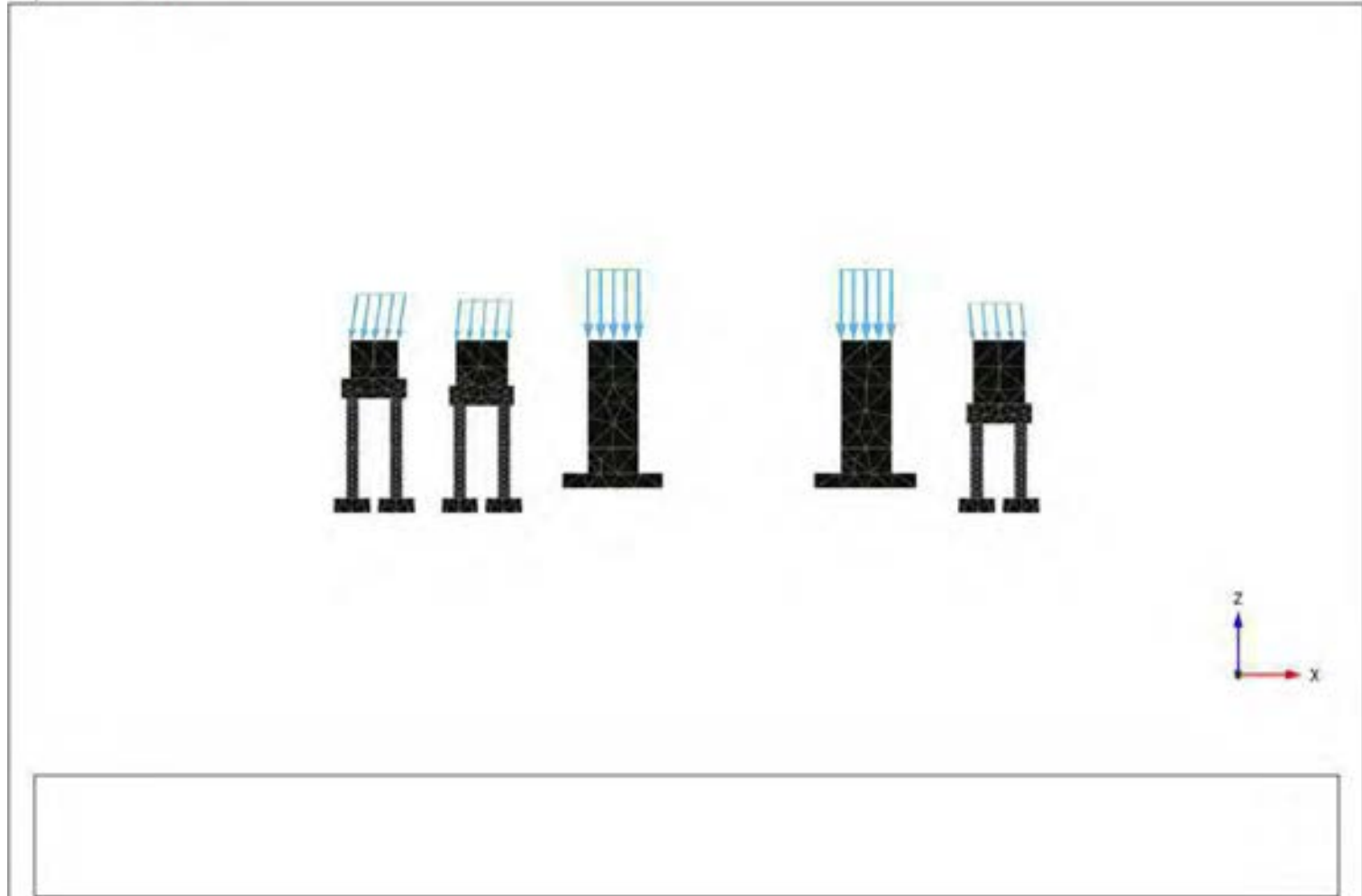

 THURBER ENGINEERING LTD.	Project description	30442-Rainbow Valley Bridge-Pier 1		Date	2021-06-23
	Project Name	30442-Rainbow Valley Bri ...	Step	49	Company

Figure D2: Finite Element Mesh Used in the Analyses Showing Substructures – Pier 1

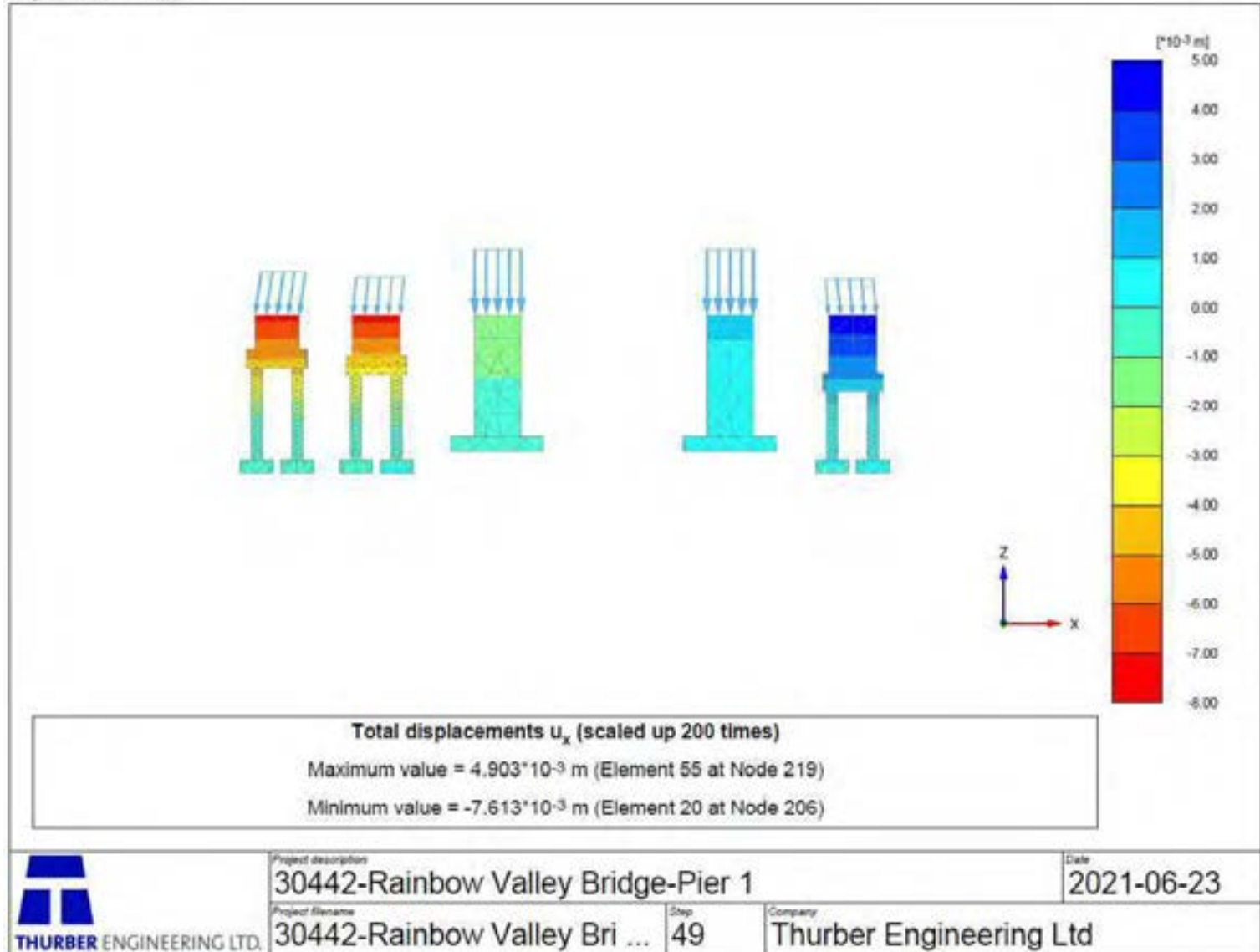

Figure D3: Contours Showing Transverse Deformation (u_x) – Pier 1

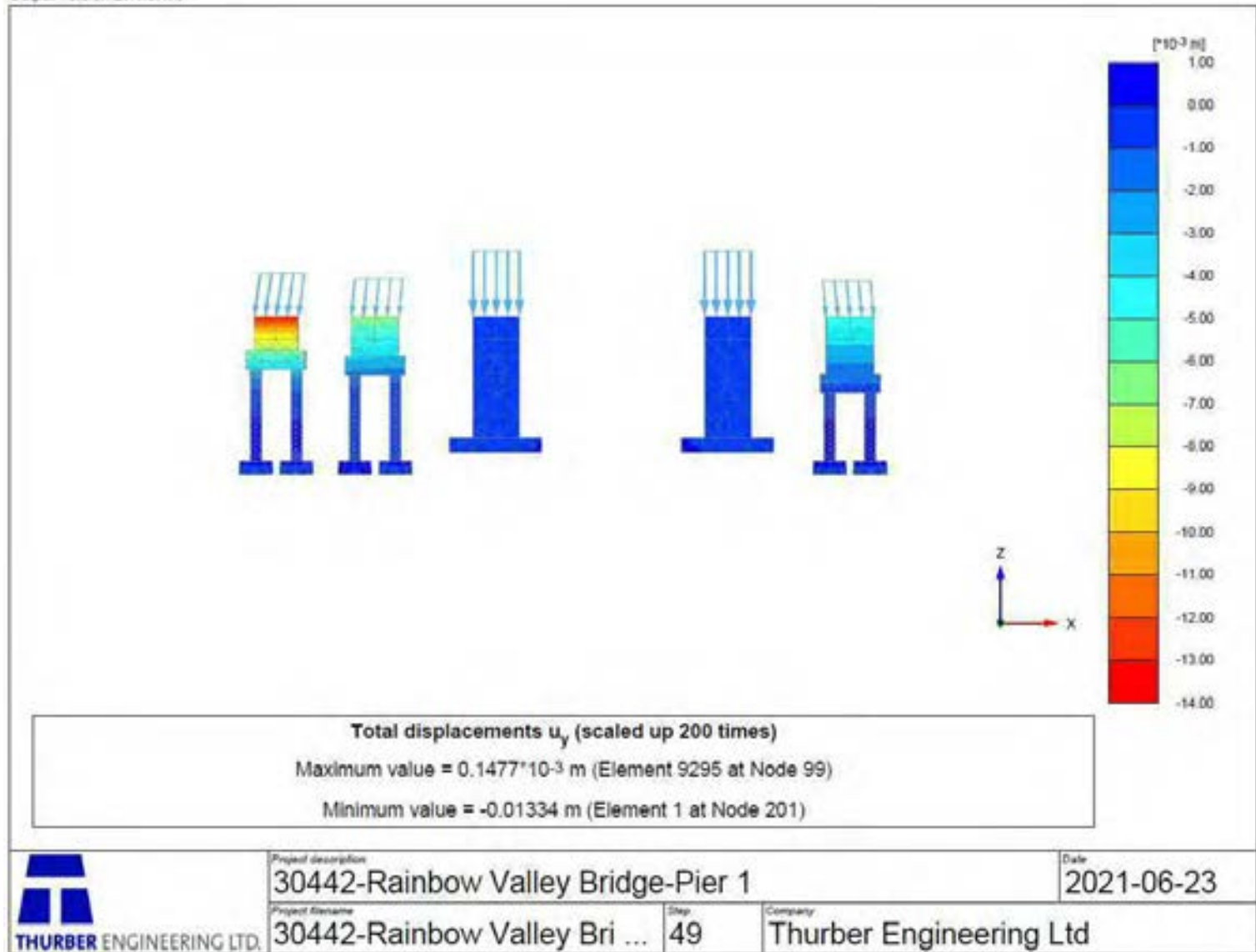

Figure D4: Contours Showing Longitudinal Deformation (u_y) – Pier 1

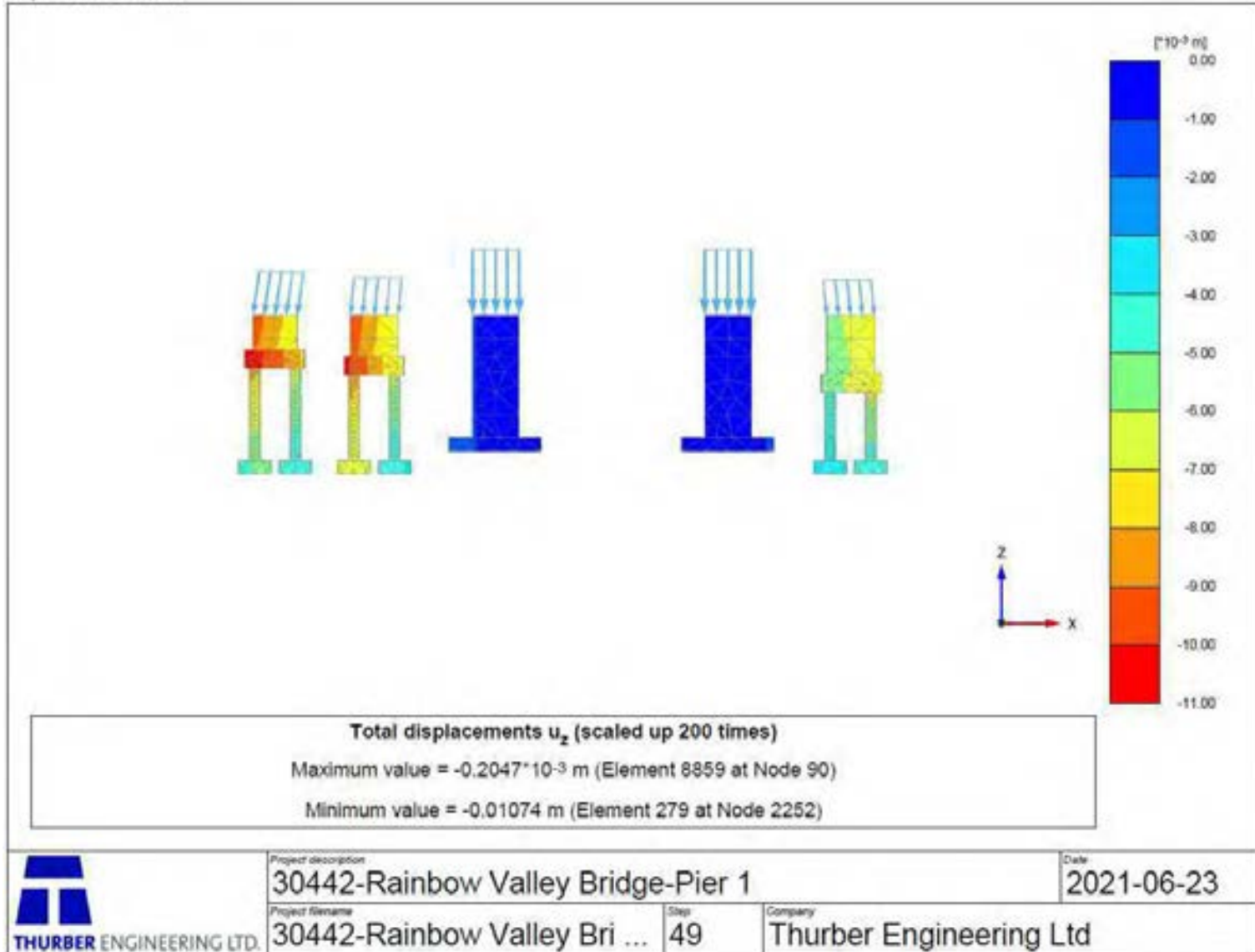

Figure D5: Contours Showing Vertical Deformation (u_z) – Pier 1

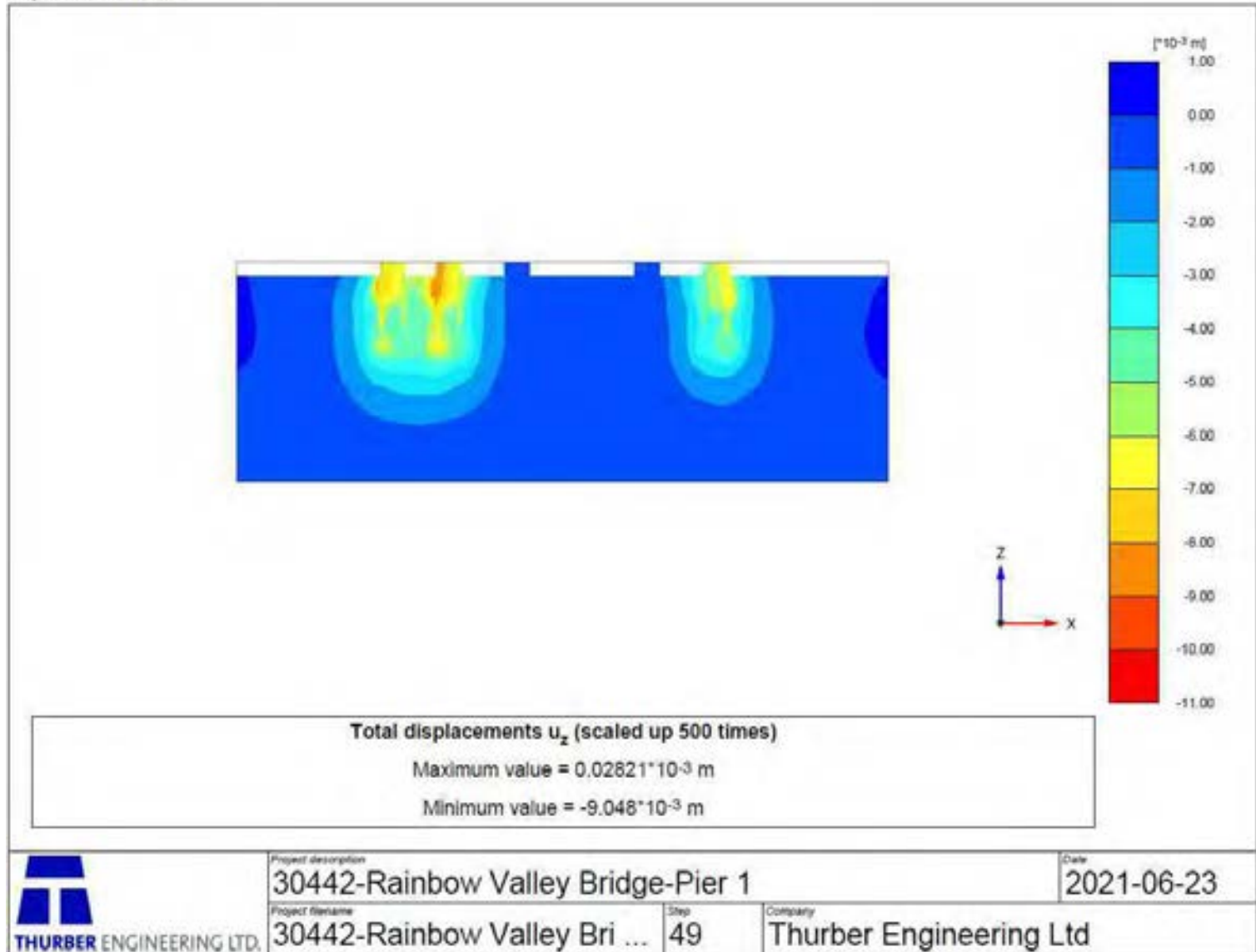
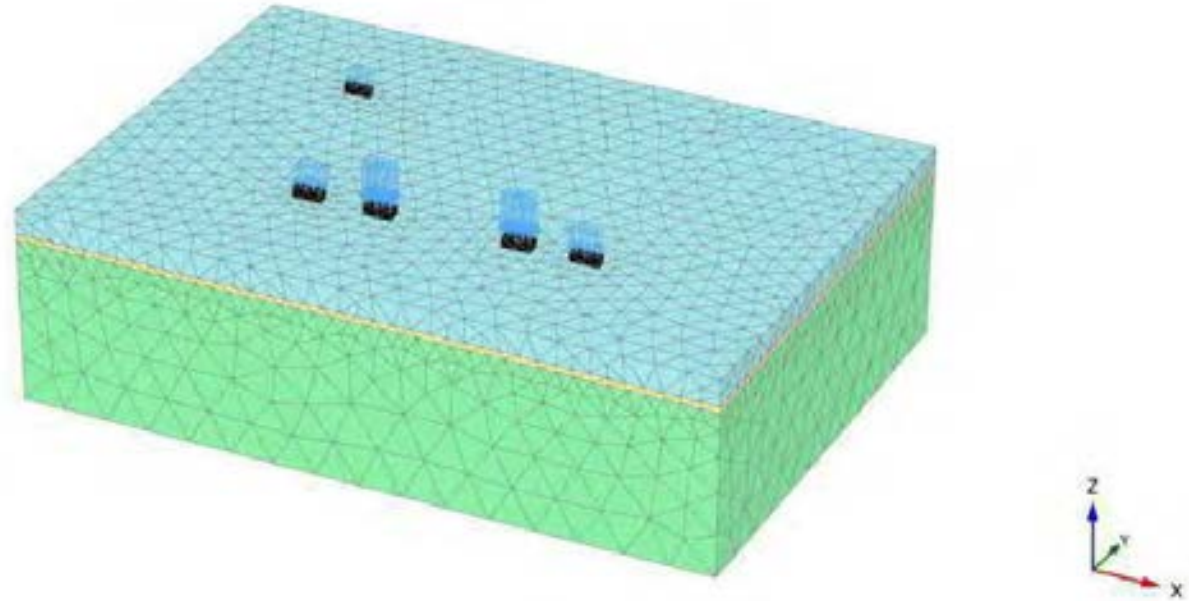
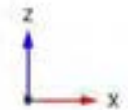

Figure D6: Contours Showing Vertical Deformation – Pier 1 Cross Section



Project description	30442-Rainbow Valley Bridge		Date	2021-06-21	
Project filename	30442-Rainbow Valley Bri ...	Step	17	Company	Thurber Engineering Ltd

Figure D7: Finite Element Mesh Used in the Analyses – Pier 2



THURBER ENGINEERING LTD.

Project description
30442-Rainbow Valley Bridge

Date
2021-06-23

Project filename
30442-Rainbow Valley Bri ...

Step
35

Company
Thurber Engineering Ltd

Figure D8: Finite Element Mesh Used in the Analyses Showing Substructures – Pier 2

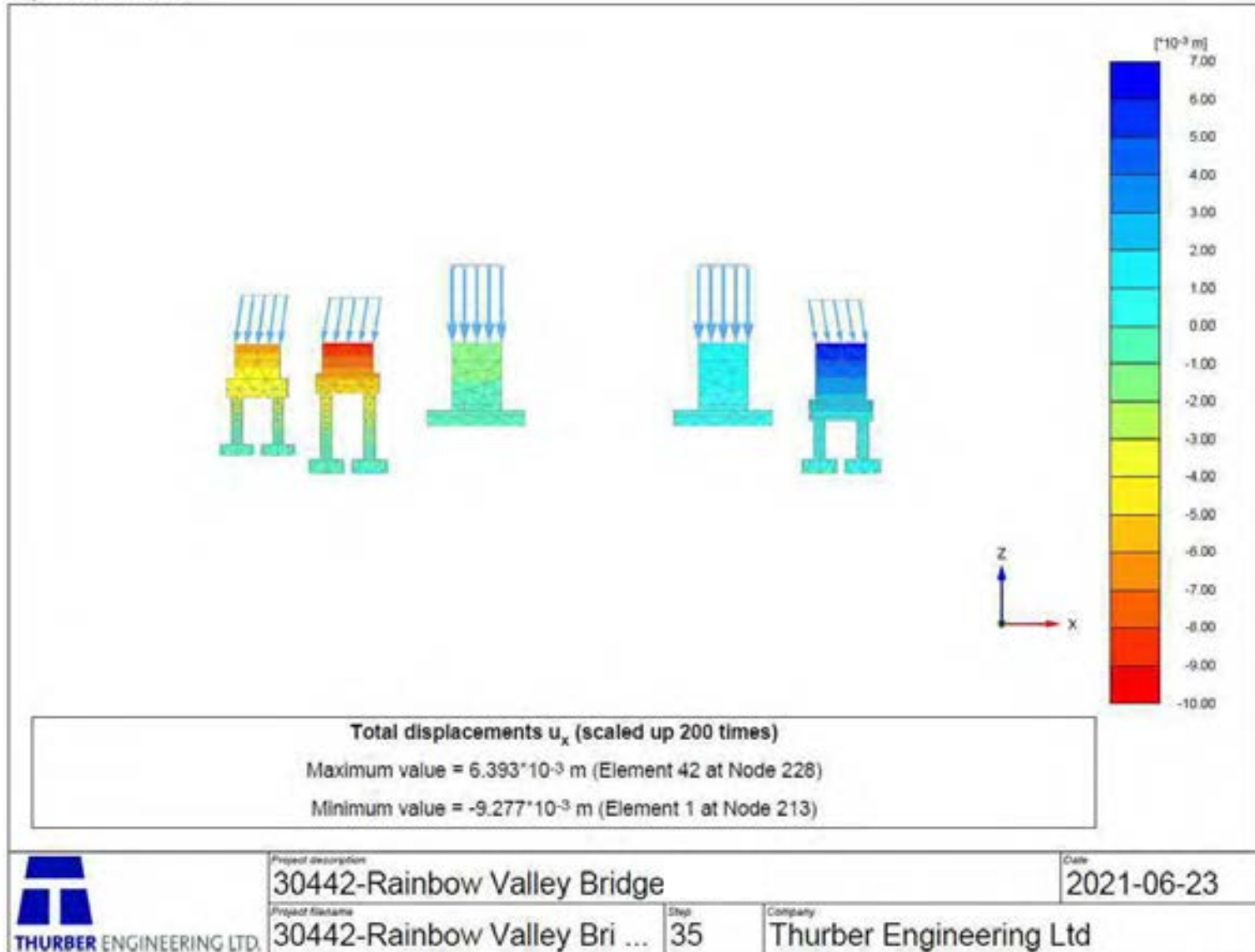

Figure D9: Contours Showing Transverse Deformation (u_x) – Pier 2

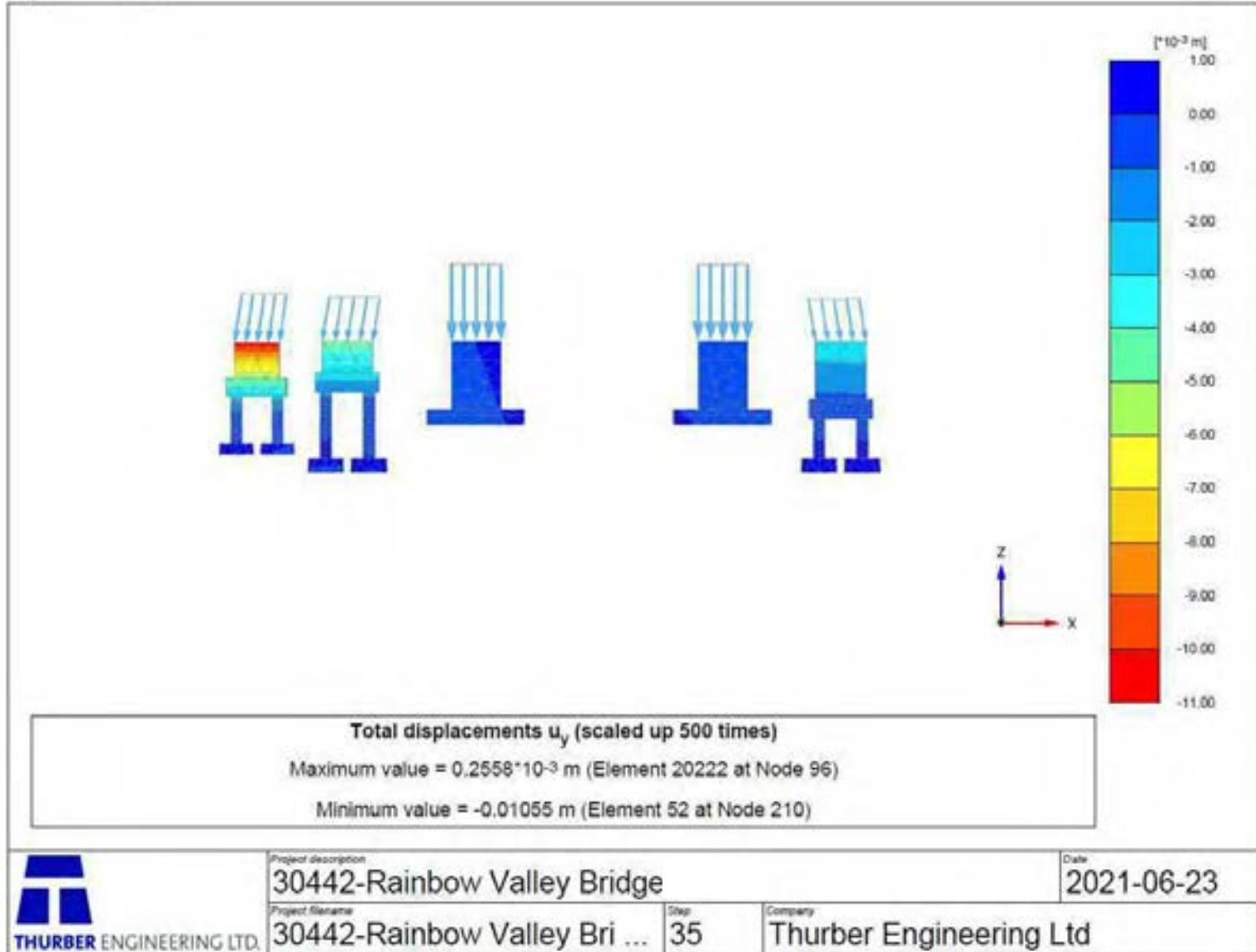

Figure D10: Contours Showing Longitudinal Deformation (u_y) – Pier 2

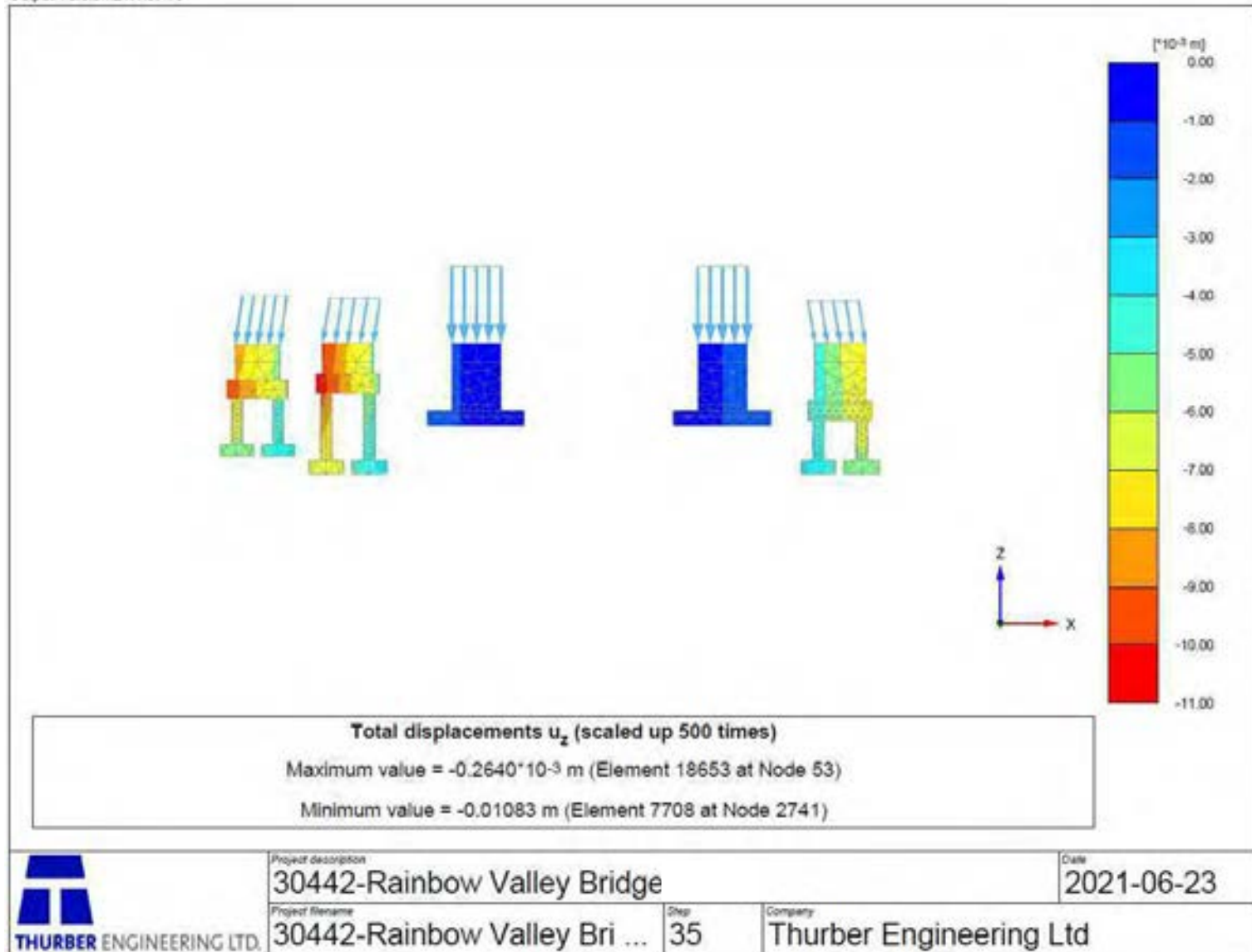

Figure D11: Contours Showing Vertical Deformation (u_z) – Pier 2

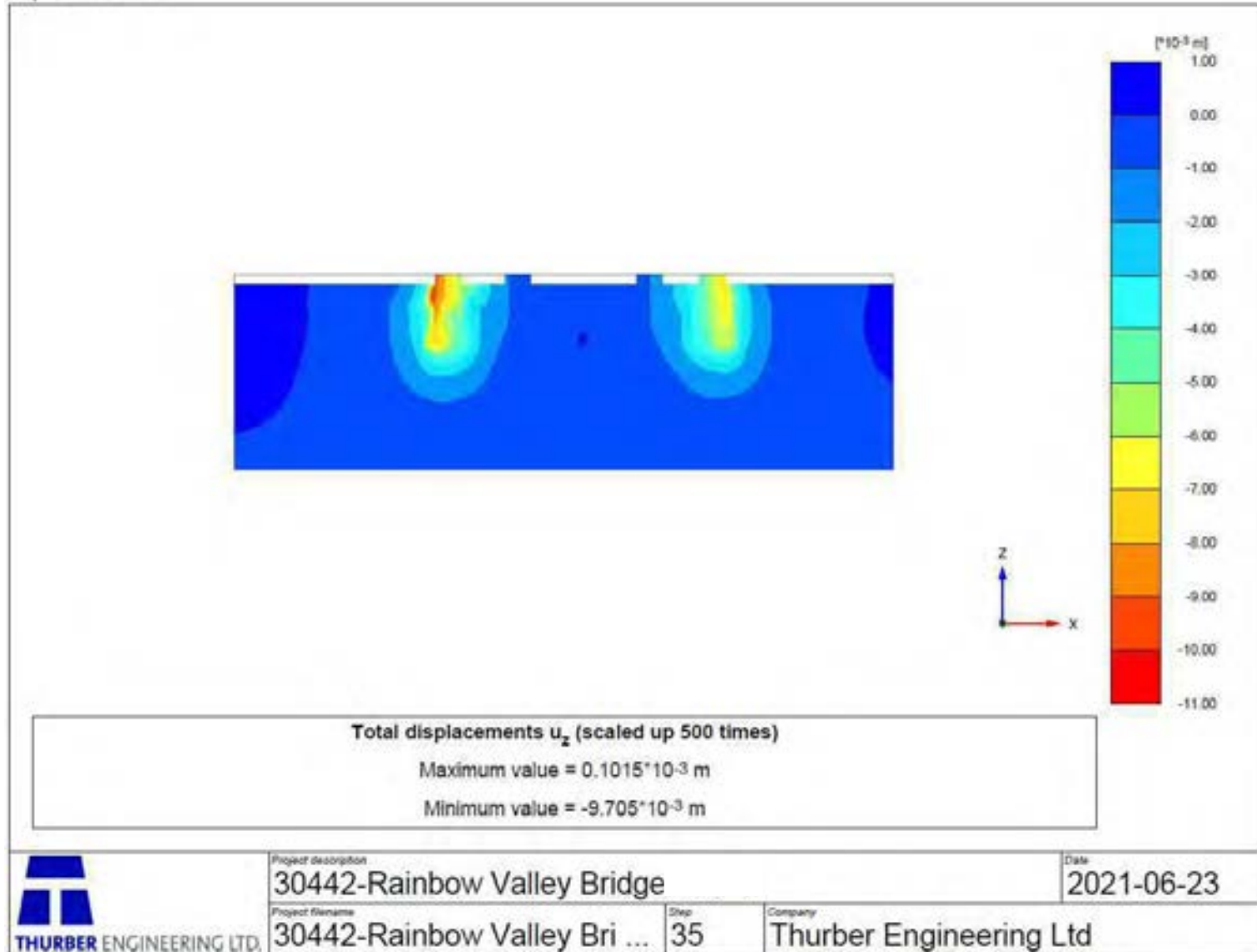

Figure D12: Contours Showing Vertical Deformation – Pier 2 Cross Section

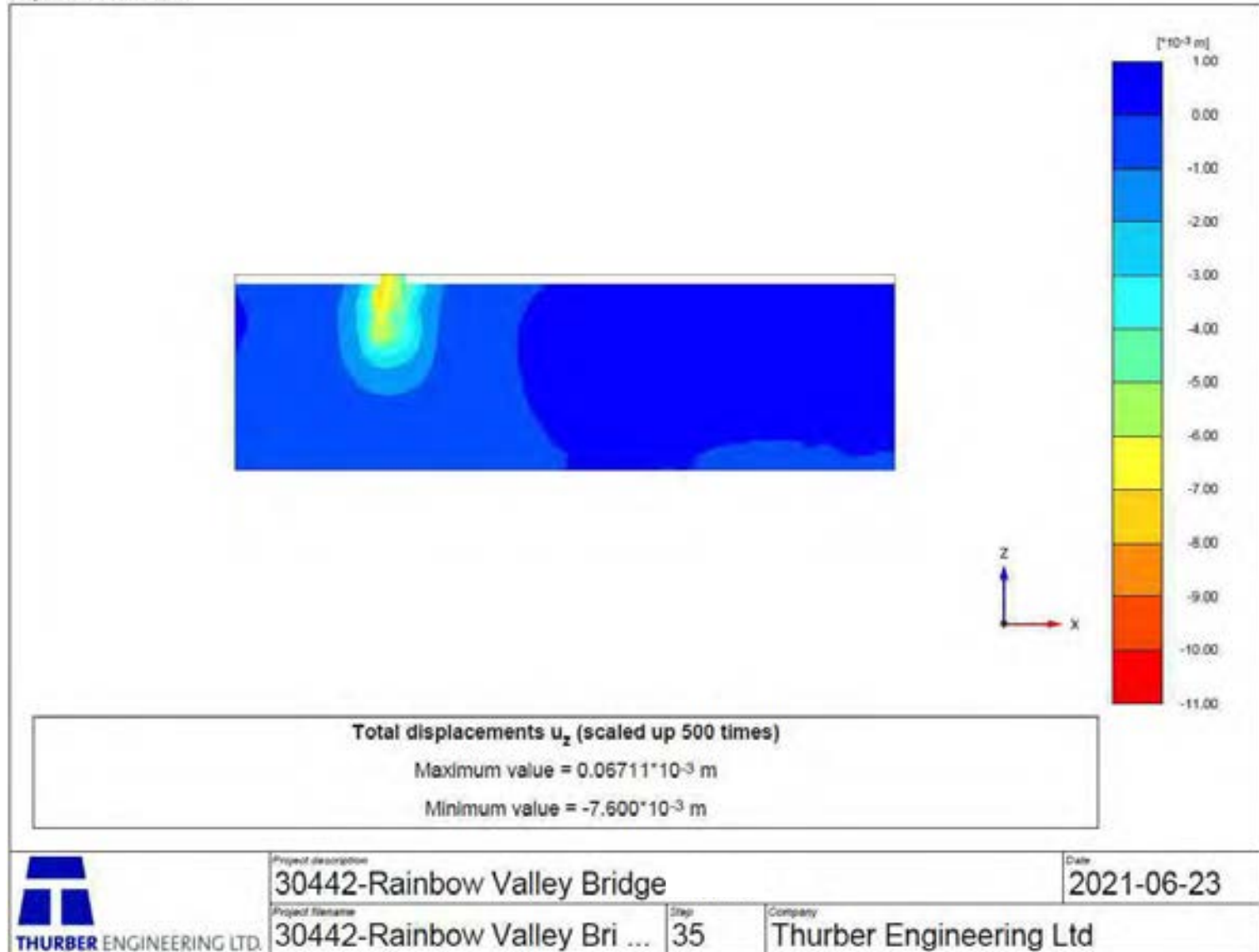
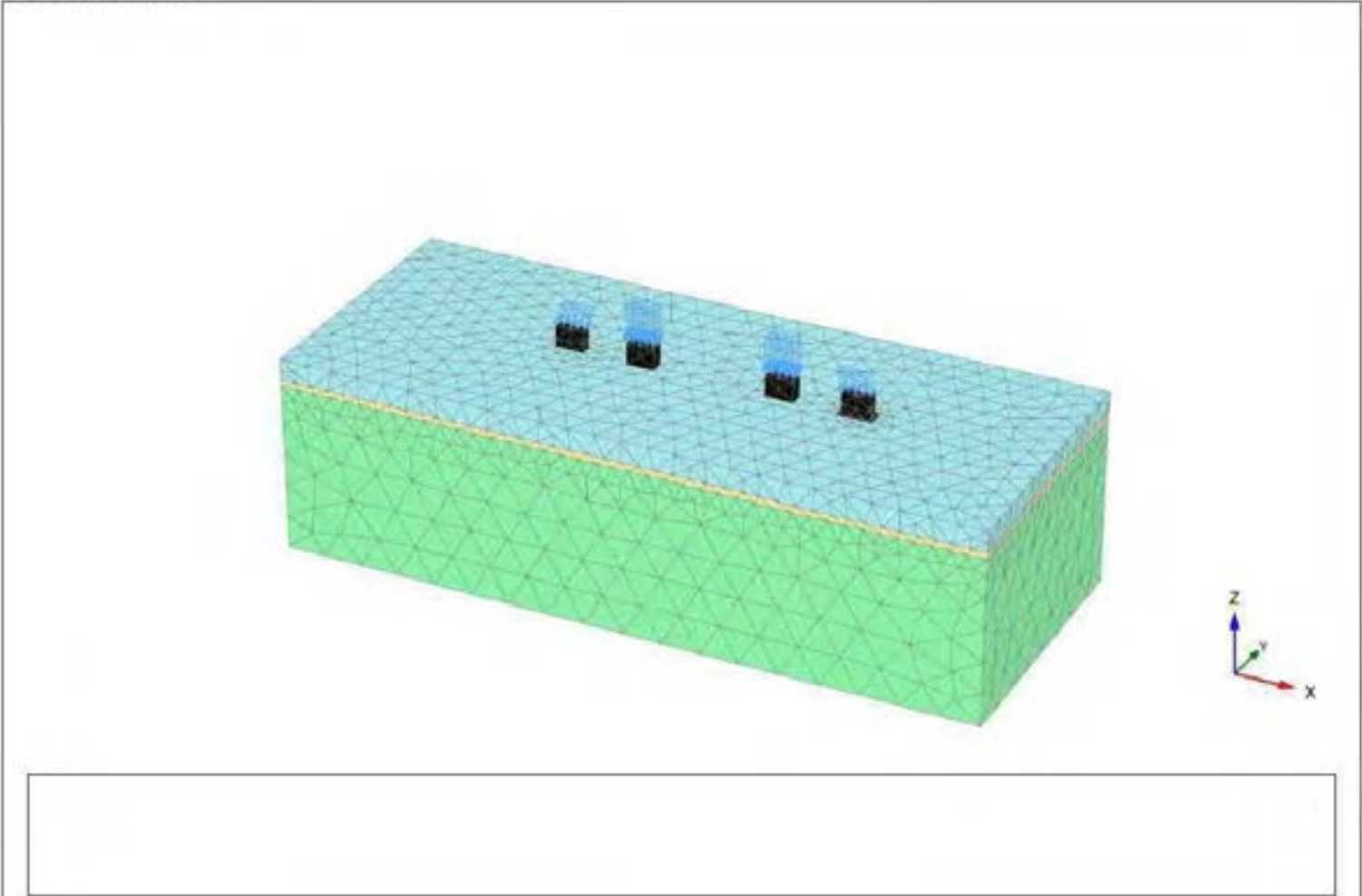

Figure D13: Contours Showing Vertical Deformation – Pier 2 Cross Section SUP



<small>Project description</small> 30442-Rainbow Valley Bridge	<small>Date</small> 2021-06-21	
<small>Project Name</small> 30442-Rainbow Valley Bri ...	<small>Step</small> 22	<small>Company</small> Thurber Engineering Ltd

Figure D14: Finite Element Mesh Used in the Analyses – Pier 3

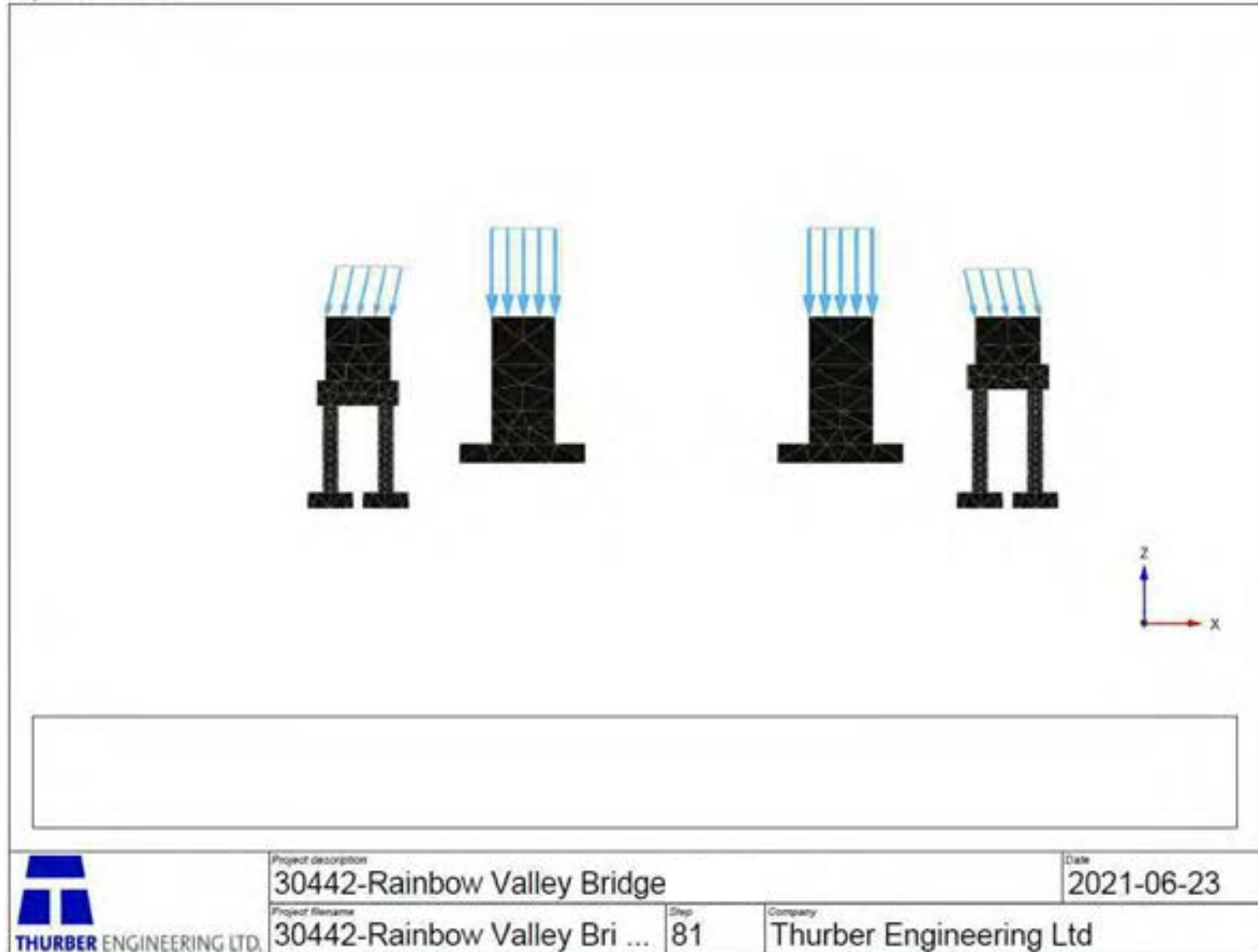

Figure D15: Finite Element Mesh Used in the Analyses Showing Substructures – Pier 3

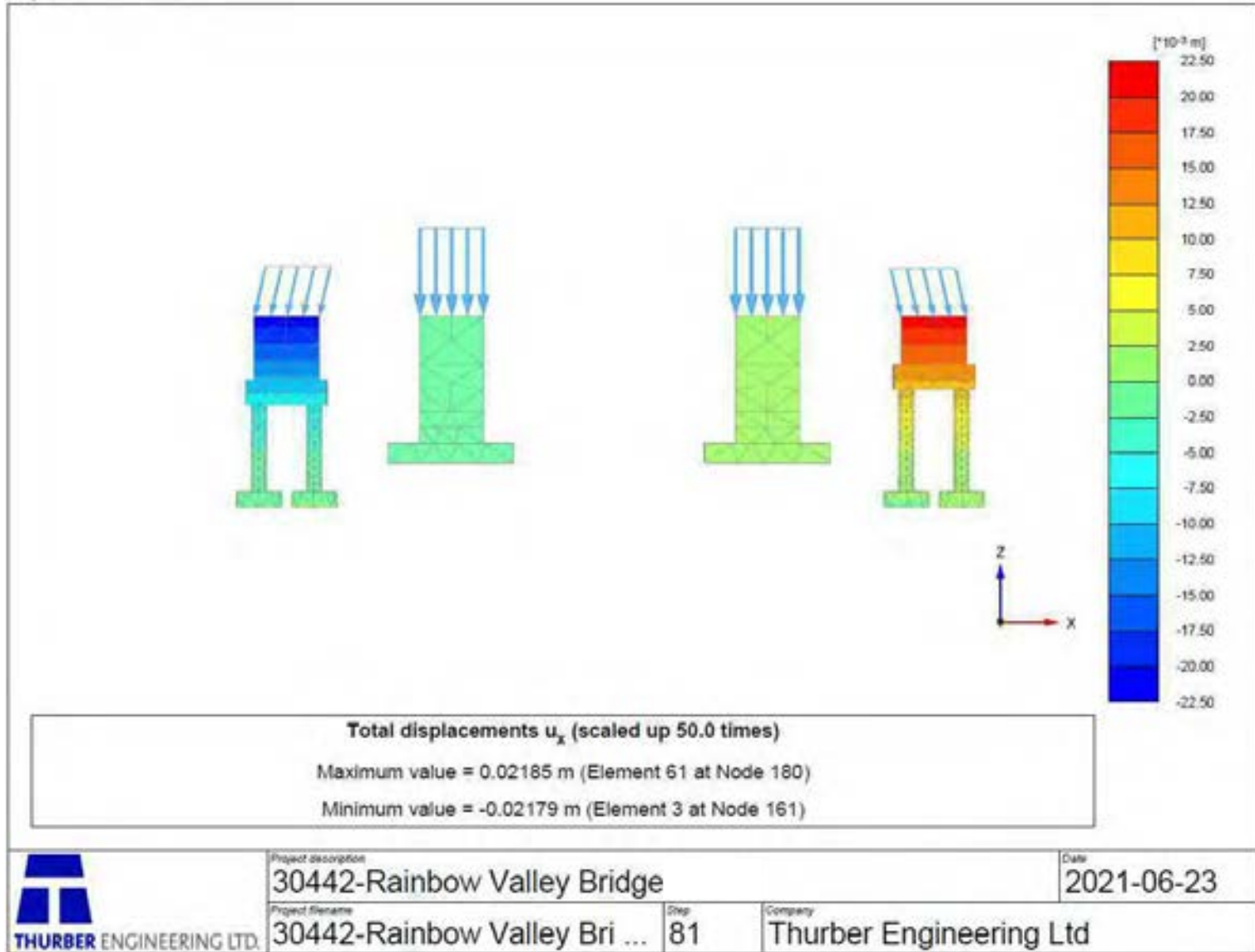

Figure D16: Contours Showing Transverse Deformation (u_x) – Pier 3

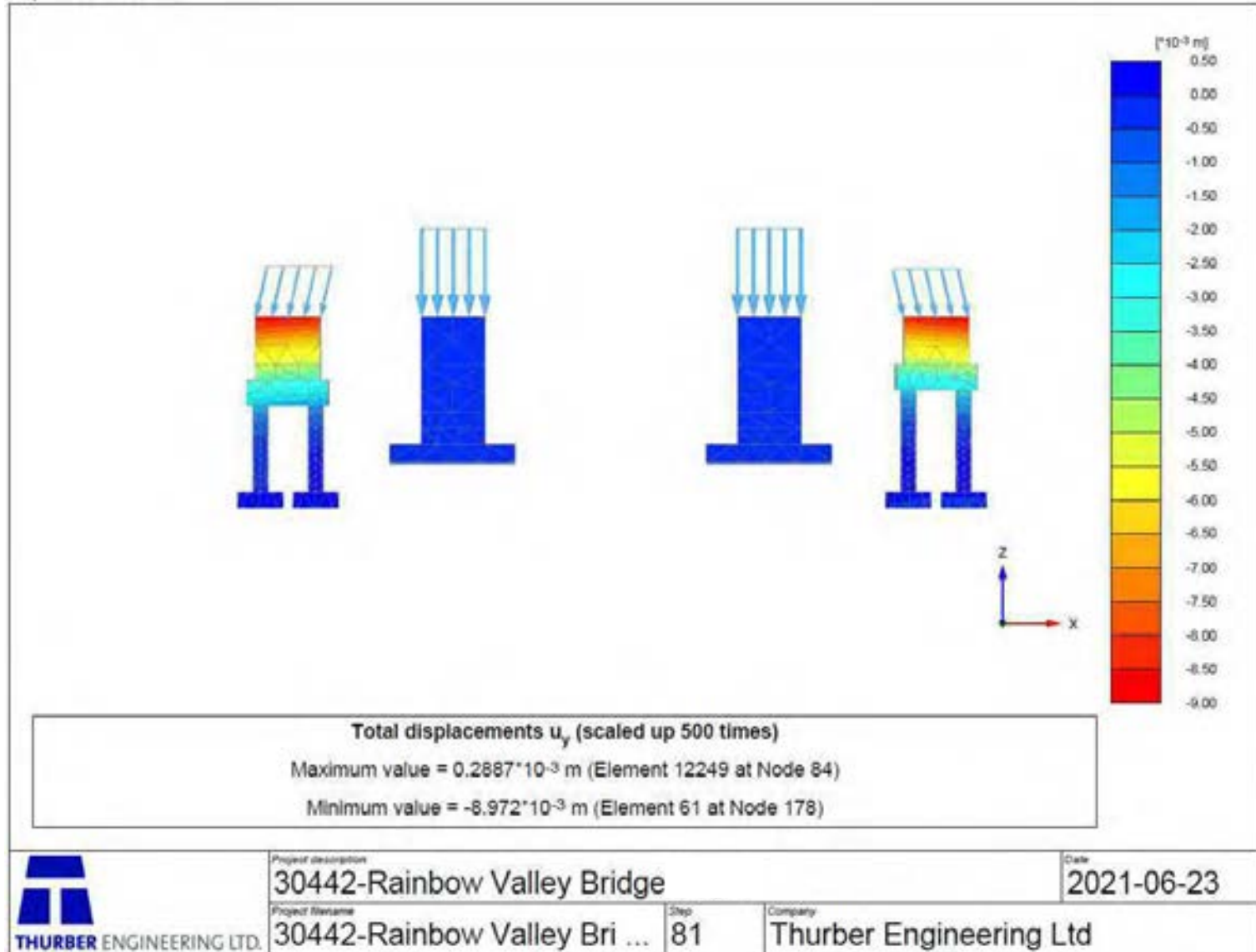

Figure D17: Contours Showing Longitudinal Deformation (u_y) – Pier 3

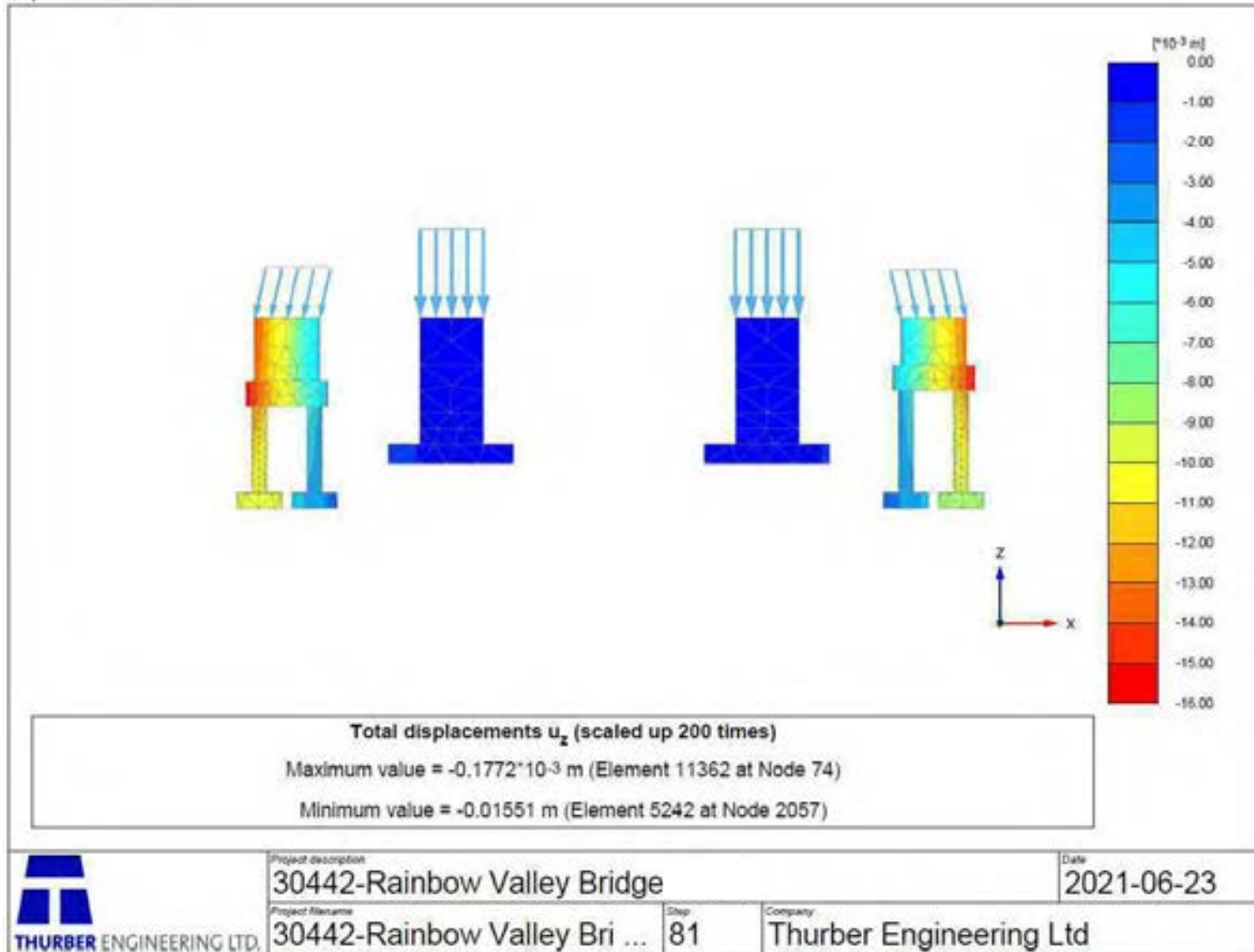

Figure D18: Contours Showing Vertical Deformation (u_z) – Pier 3

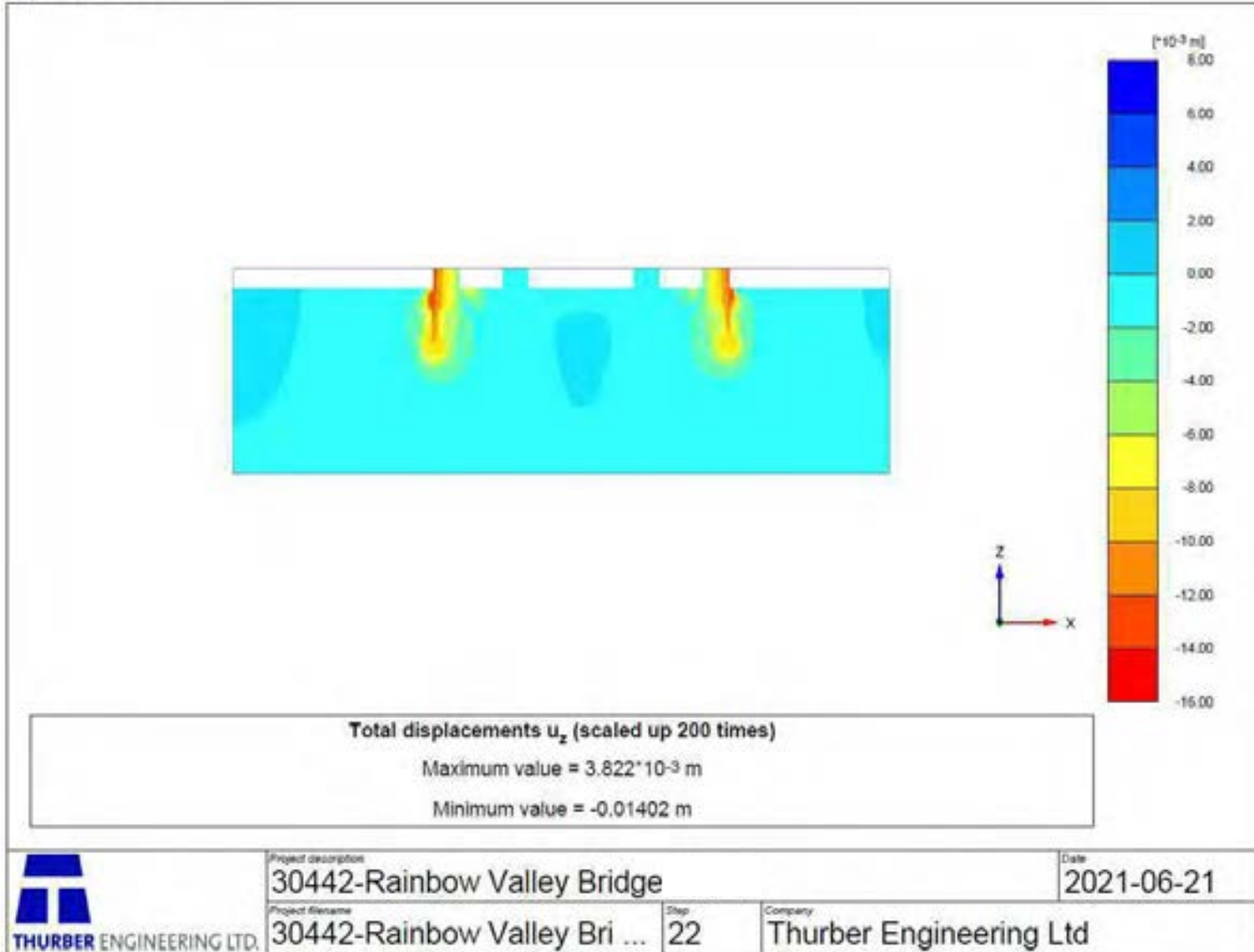
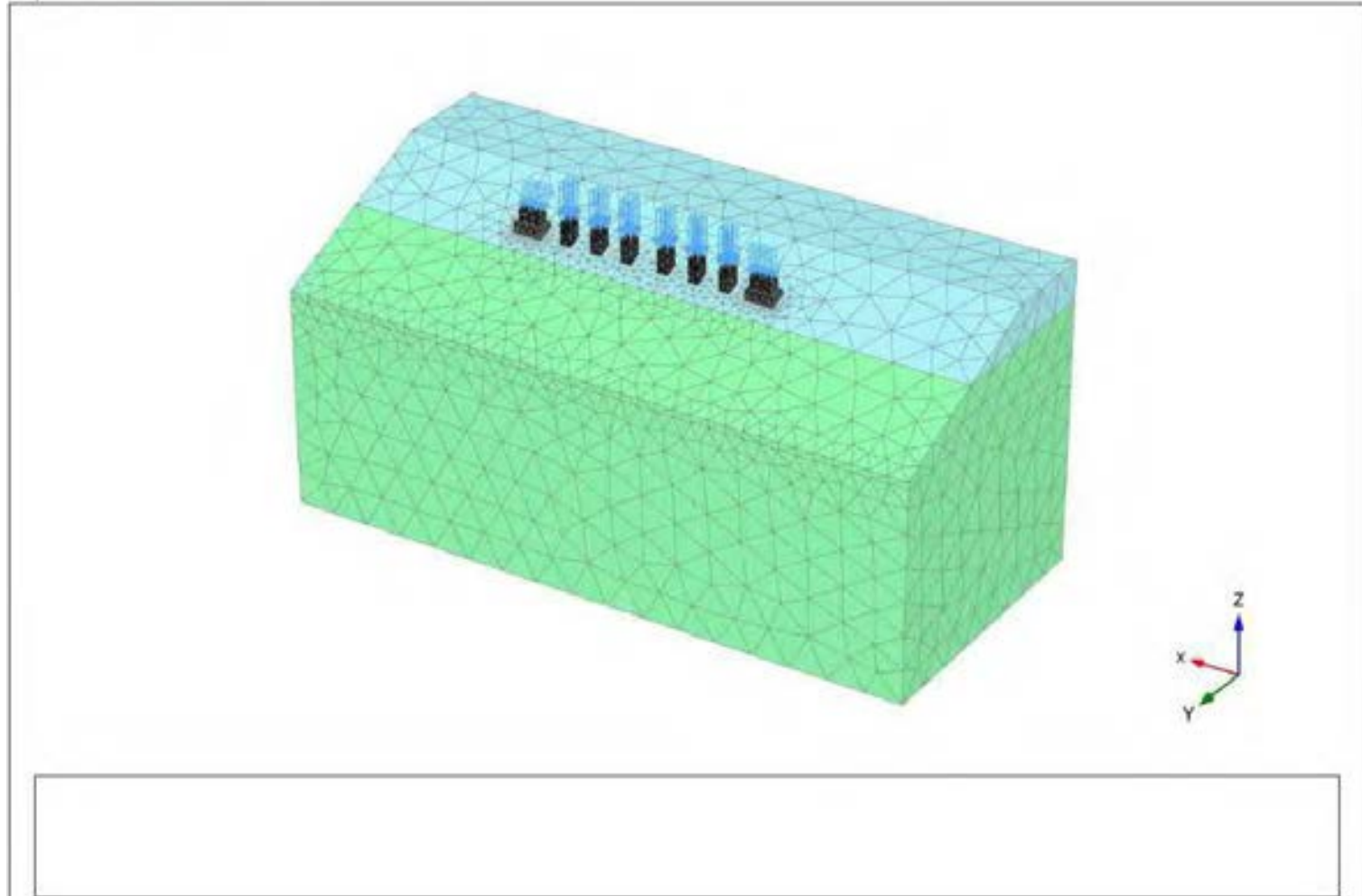

Figure D19: Contours Showing Vertical Deformation – Pier 3 Cross Section



 THURBER ENGINEERING LTD.	Project description		30442-Rainbow Valley Bridge		Date	2021-06-23
	Project filename	30442-Rainbow Valley Bri ...	Step	45	Company	Thurber Engineering Ltd

Figure D20: Finite Element Mesh Used in the Analyses – West Abutment (Widening Lanes)



 THURBER ENGINEERING LTD.	Project description	30442-Rainbow Valley Bridge		Date	2021-06-23
	Project Name	30442-Rainbow Valley Bri ...	Step	45	Company

Figure D21: Finite Element Mesh Showing Substructures – West Abutment (Widening Lanes)

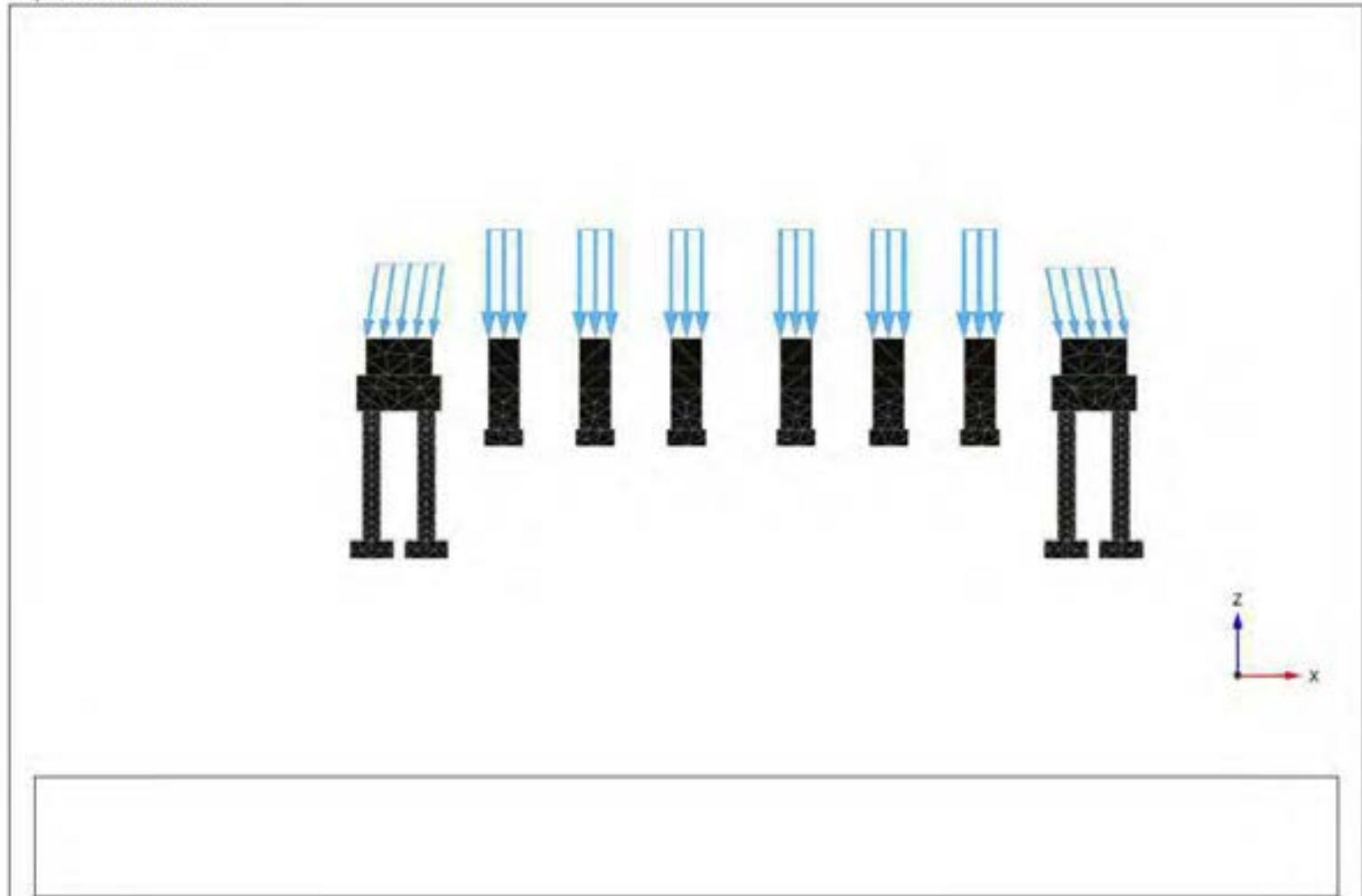
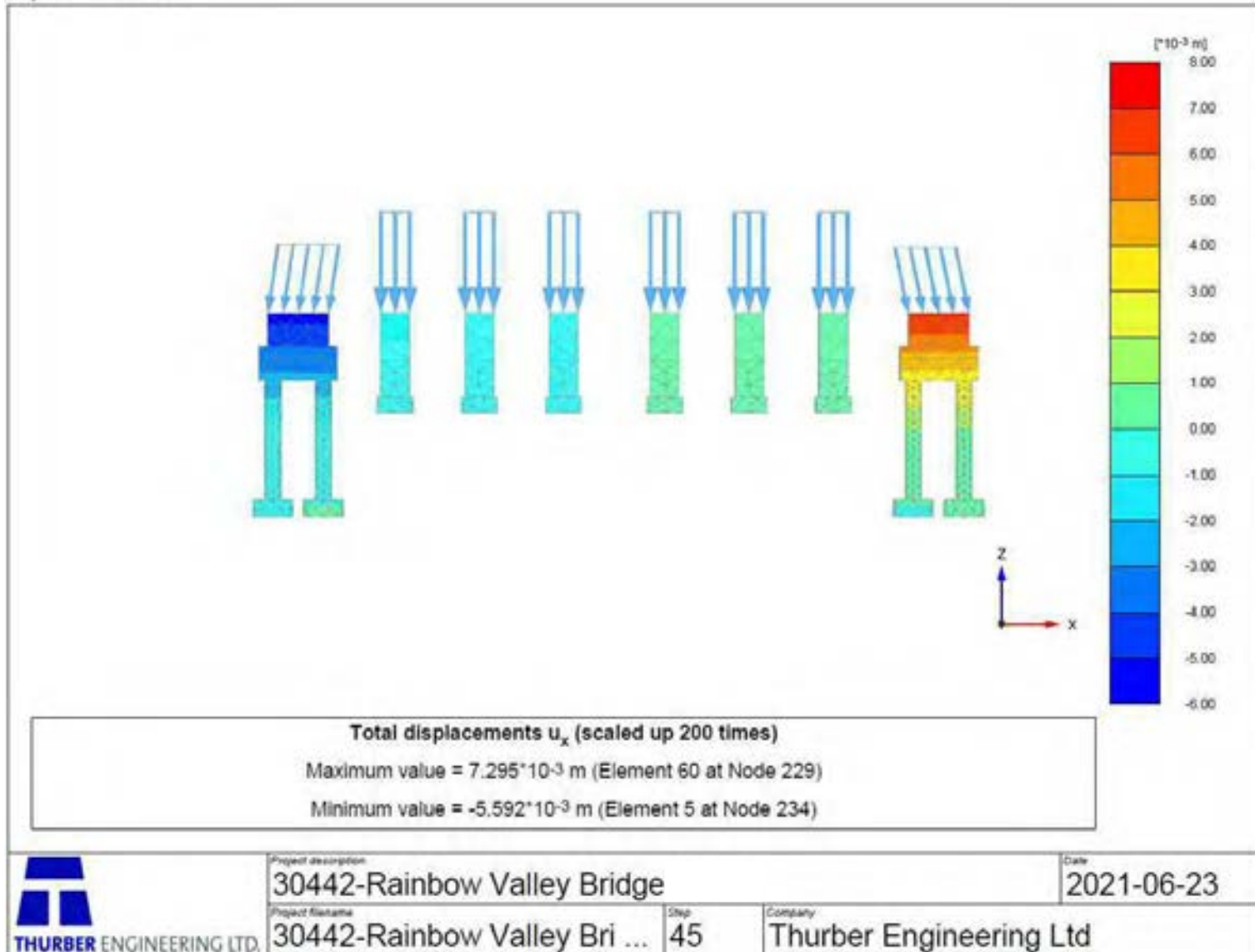

Figure D22: Contours Showing Transverse Deformation (ux) – West Abutment (Widening Lanes)

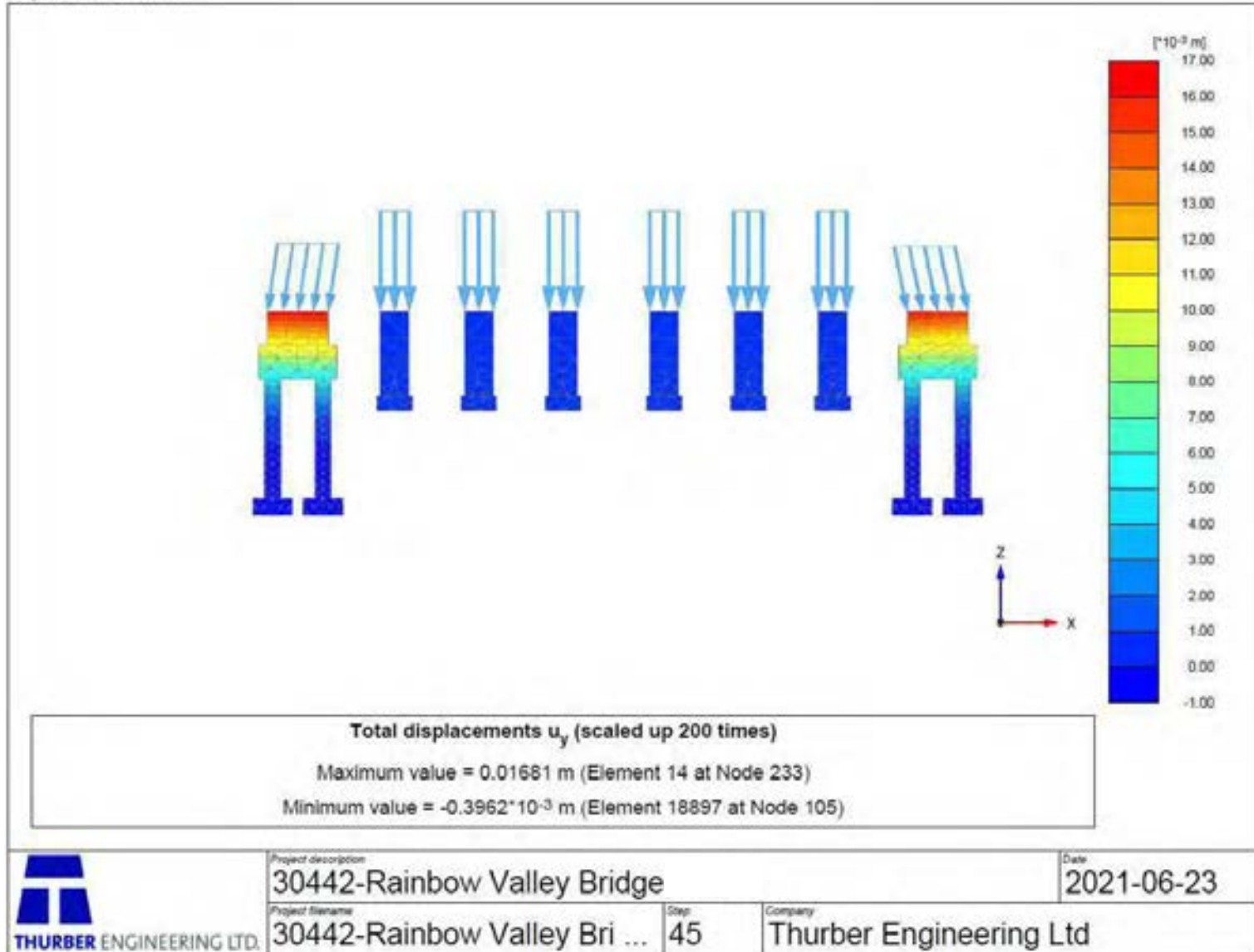

Figure D23: Contours Showing Longitudinal Deformation (u_y) – West Abutment (Widening Lanes)

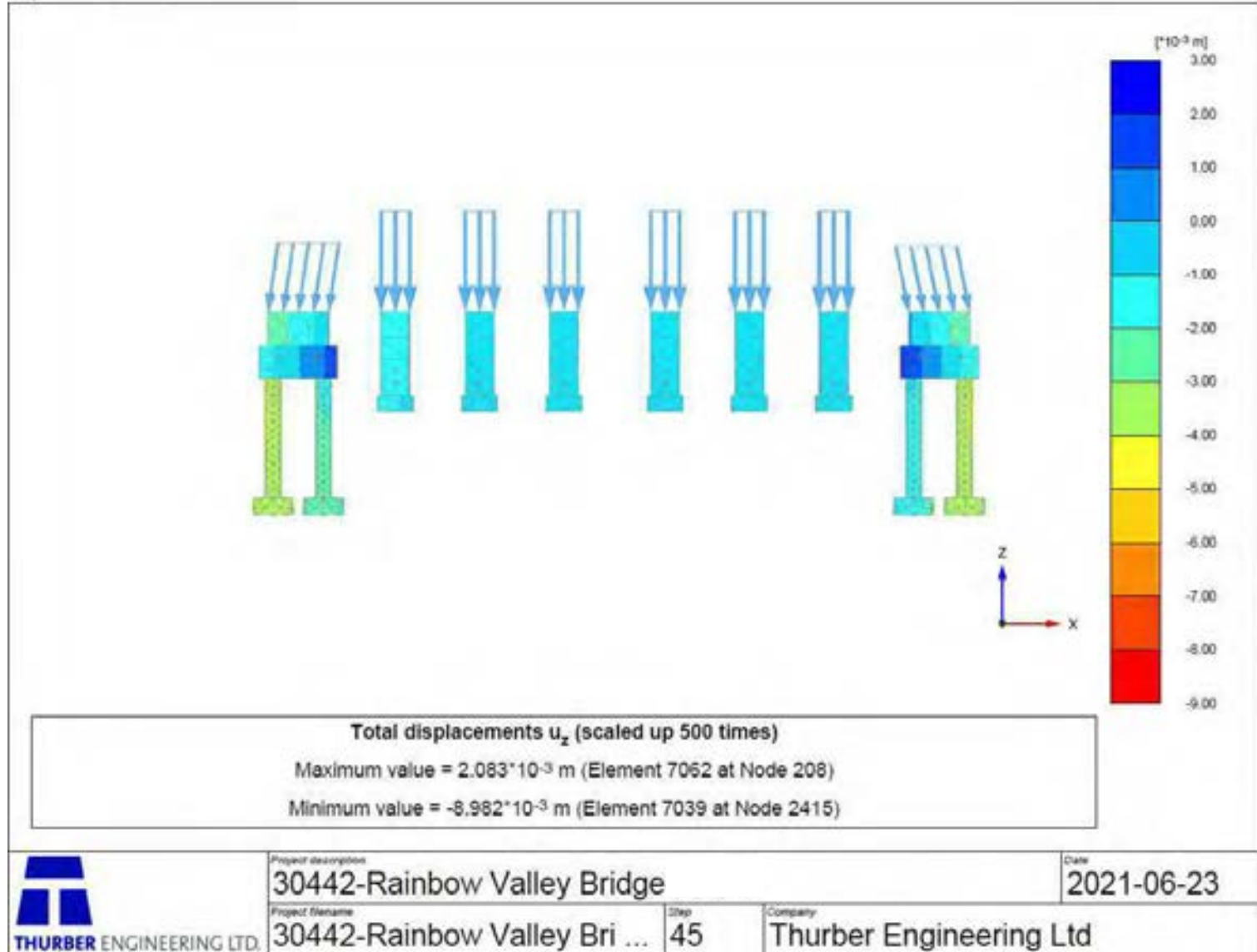

Figure D24: Contours Showing Vertical Deformation (u_z) – West Abutment (Widening Lanes)

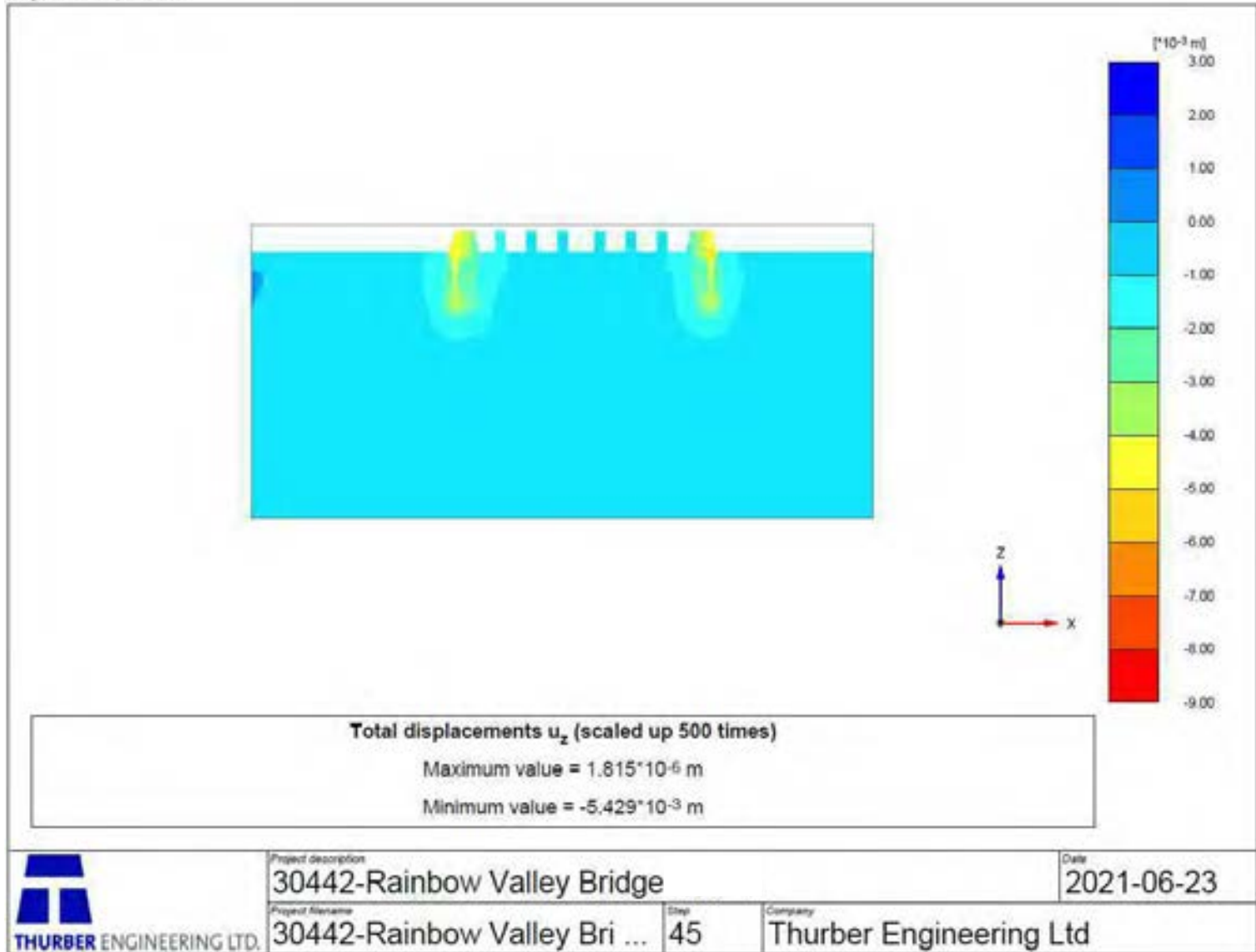
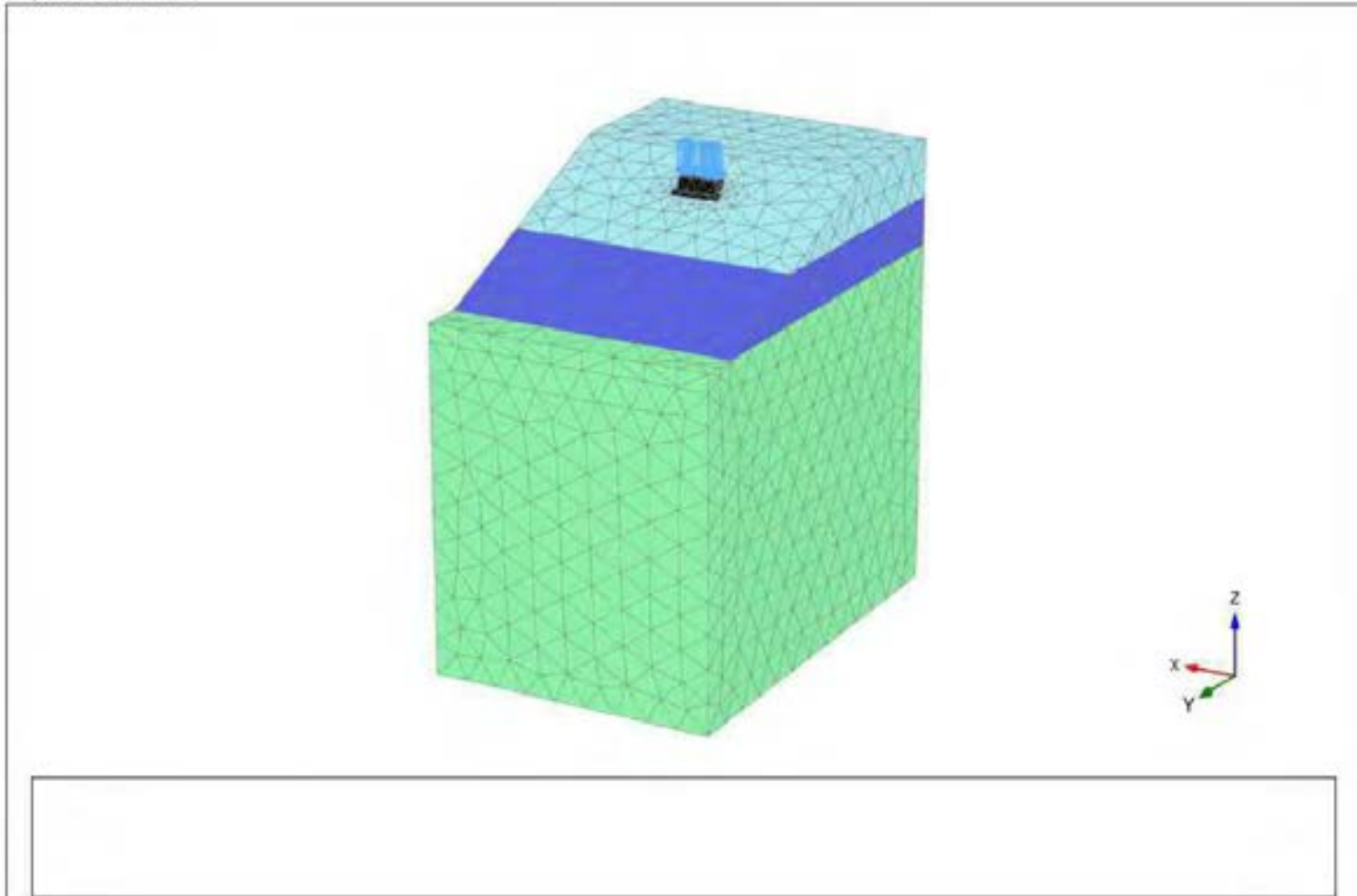

Figure D25: Contours Showing Vertical Deformation – West Abutment Cross Section (Widening Lanes)



 THURBER ENGINEERING LTD.	Project description	30442-Rainbow Valley Bridge		Date	2021-08-25
	Project Name	Step	Company		
	30442-Rainbow Valley Bri ...	14	Thurber Engineering Ltd		

Figure D26: Finite Element Mesh Used in the Analyses – West Abutment (SUP)



 THURBER ENGINEERING LTD.	Project description 30442-Rainbow Valley Bridge		Date 2021-08-25
	Project filename 30442-Rainbow Valley Bri ...	Step 14	Company Thurber Engineering Ltd

Figure D27: Finite Element Mesh Showing Substructures – West Abutment (SUP)

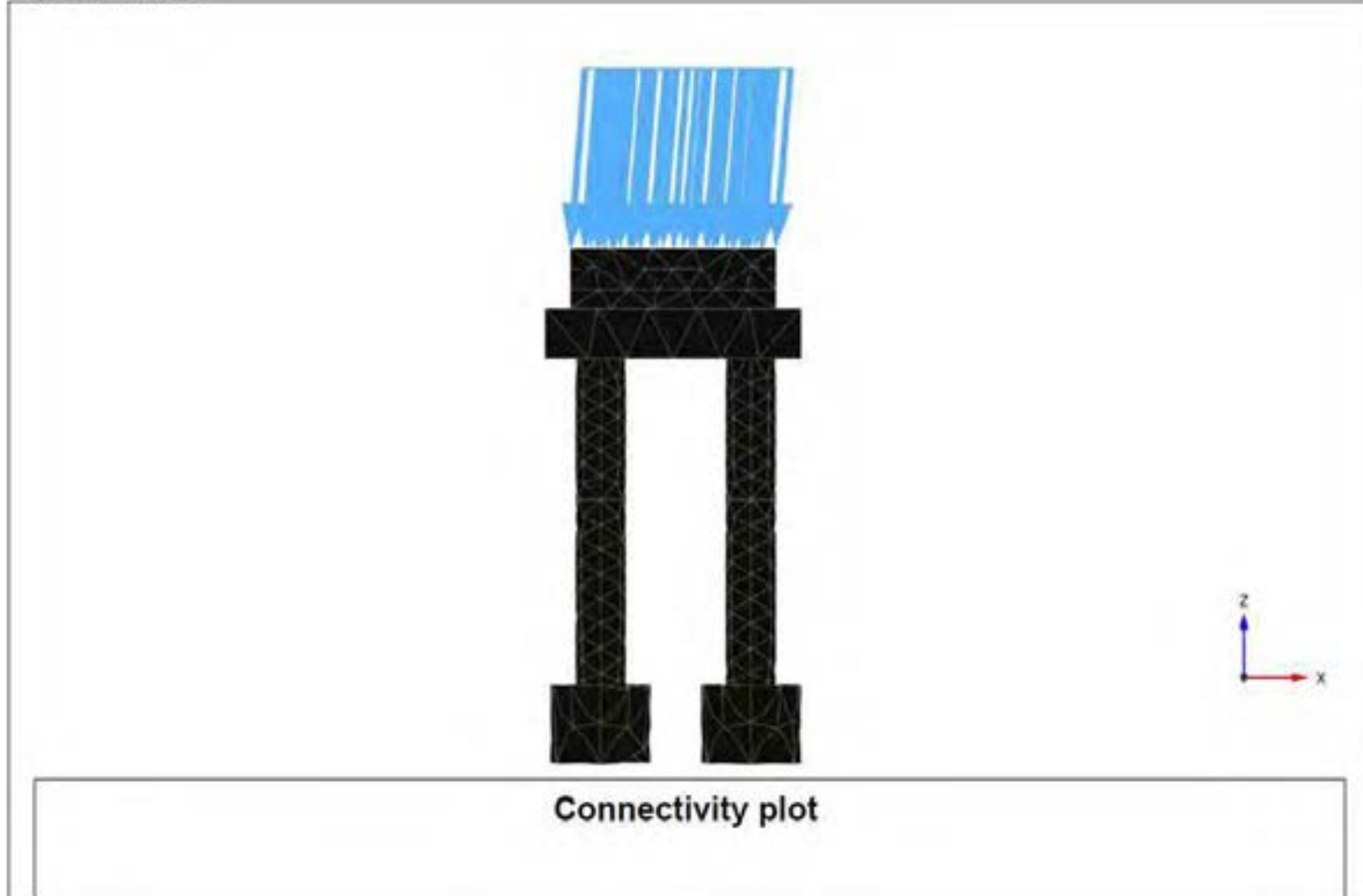
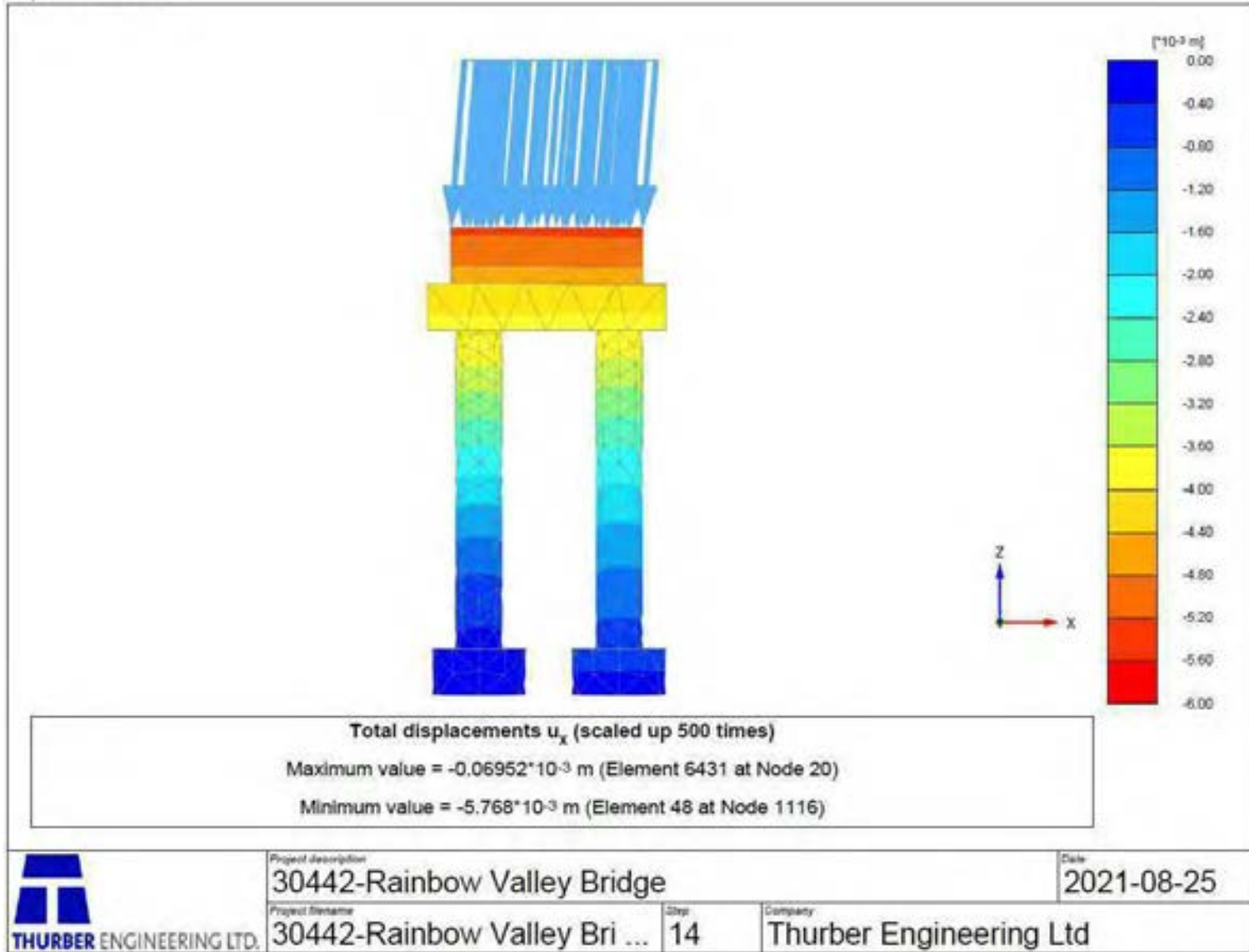

Figure D28: Contours Showing Transverse Deformation (u_x) – West Abutment (SUP)

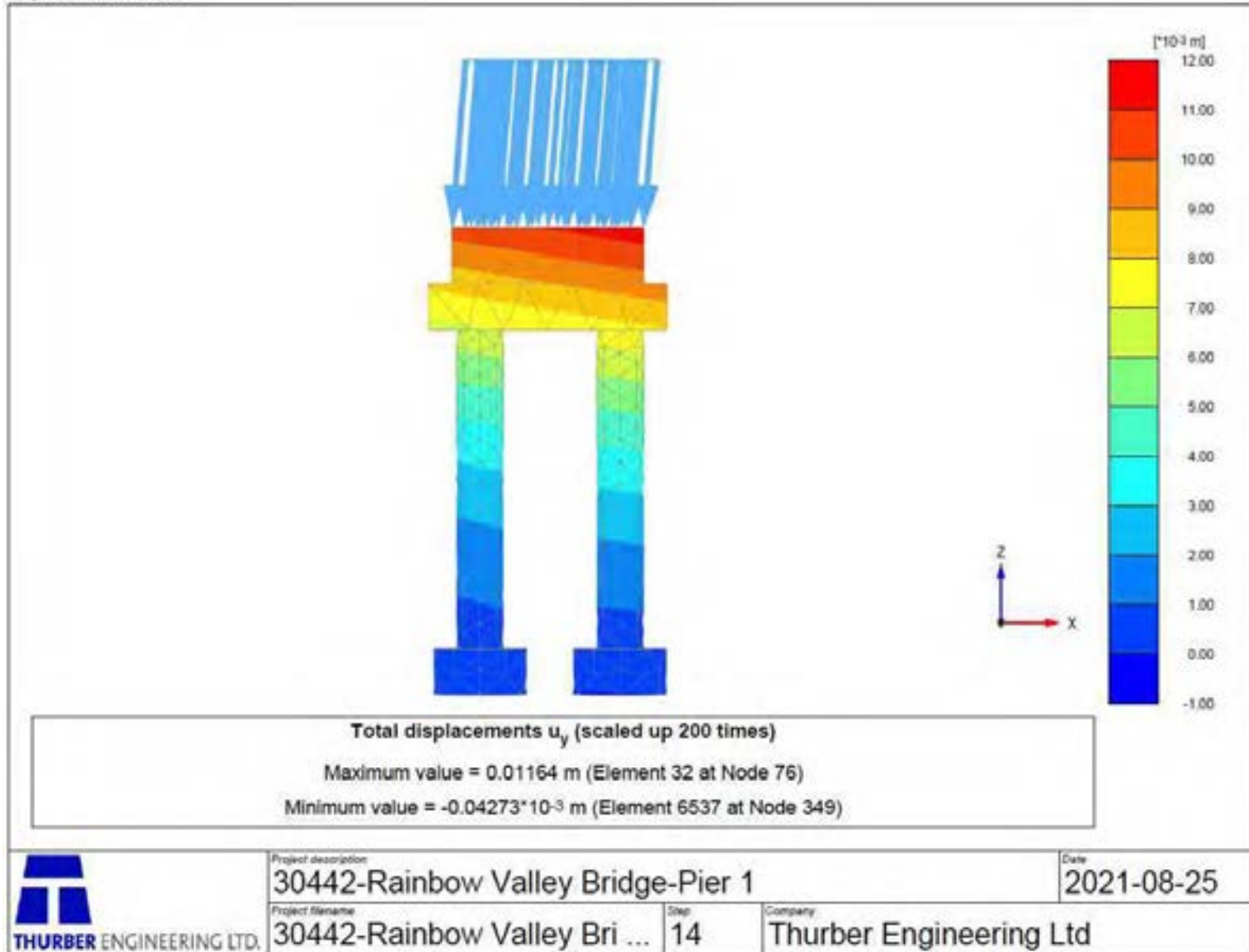

Figure D29: Contours Showing Longitudinal Deformation (u_y) – West Abutment (SUP)

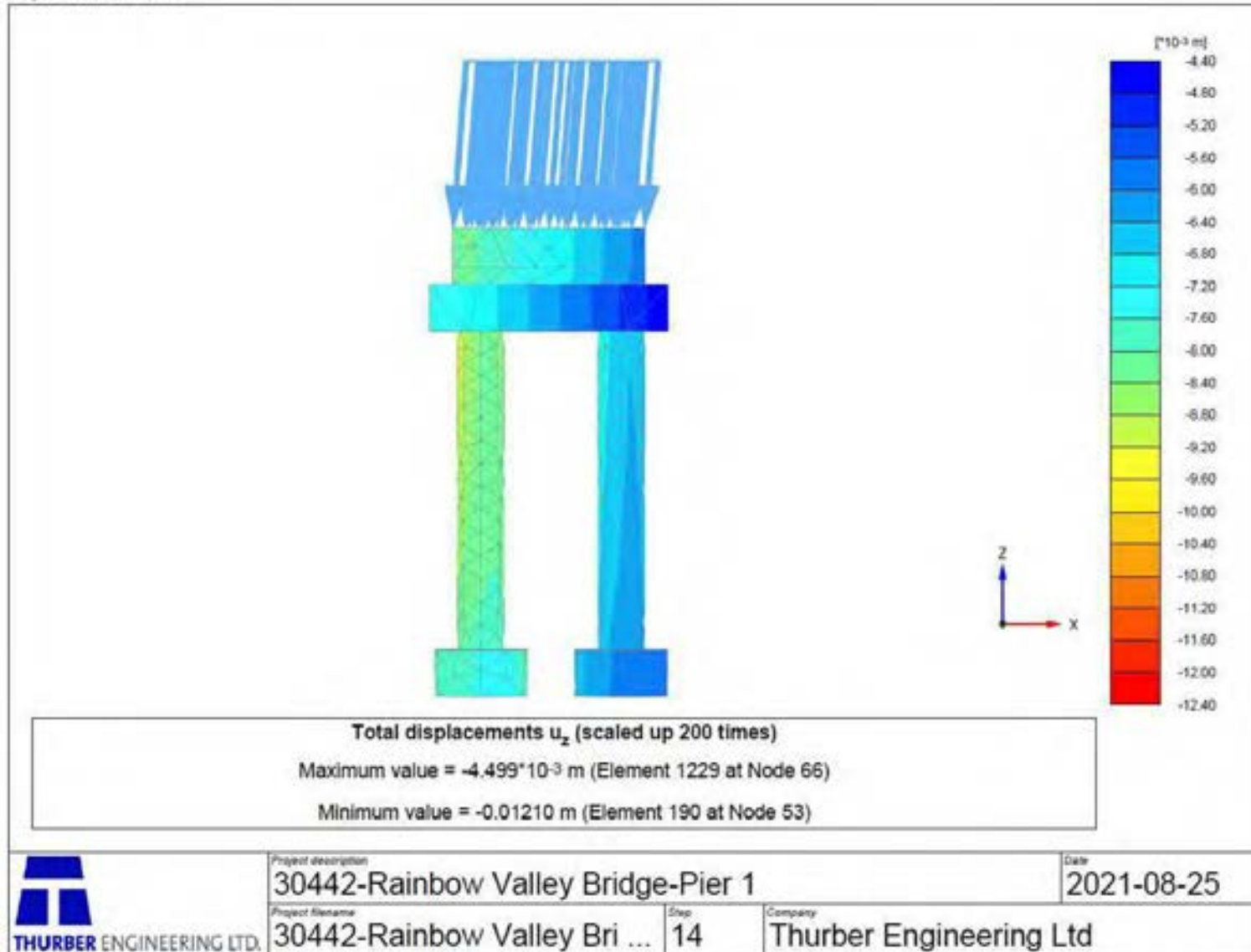

Figure D30: Contours Showing Vertical Deformation (u_z) – West Abutment (SUP)

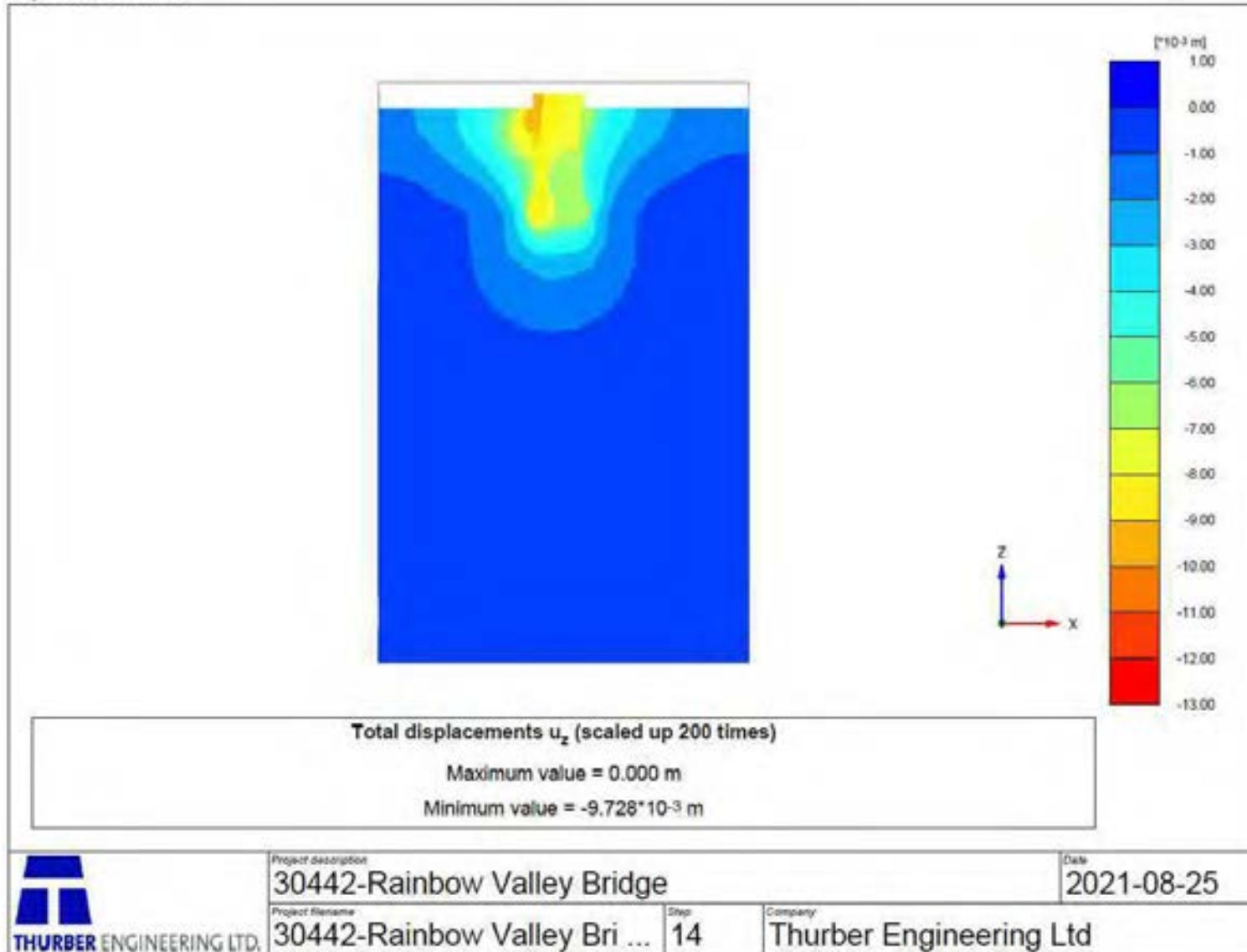
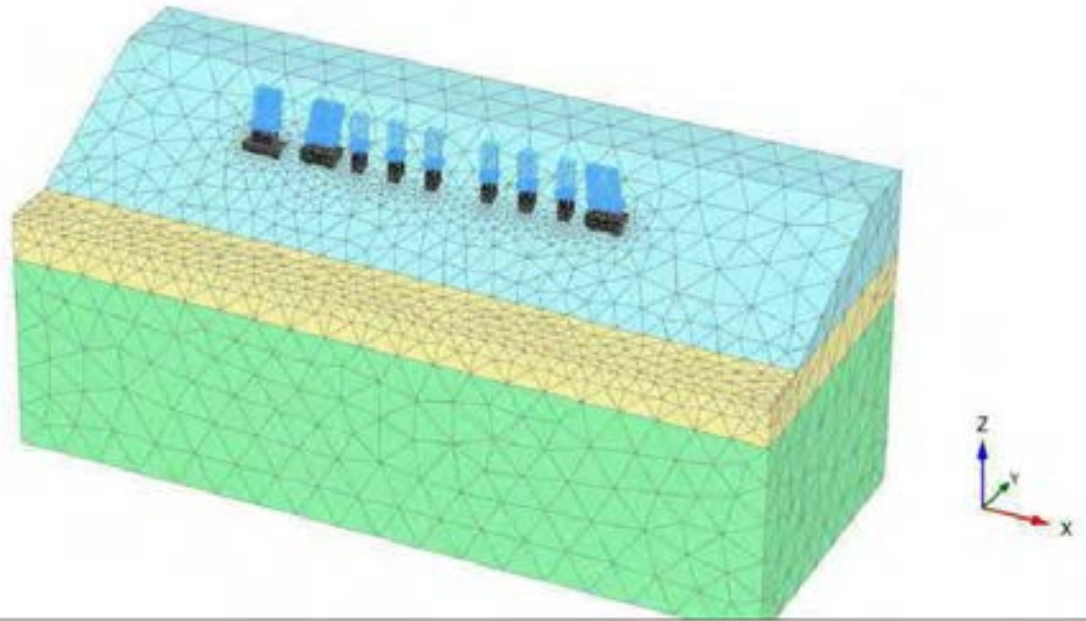

Figure D31: Contours Showing Vertical Deformation (u_z) – West Abutment Cross Section (SUP)



THURBER ENGINEERING LTD.

Project description

30442-Rainbow Valley Bridge

Date

2021-06-21

Project filename

30442-Rainbow Valley Bri ...

Draw

37

Company

Thurber Engineering Ltd

Figure D32: Finite Element Mesh Used in the Analyses – East Abutment

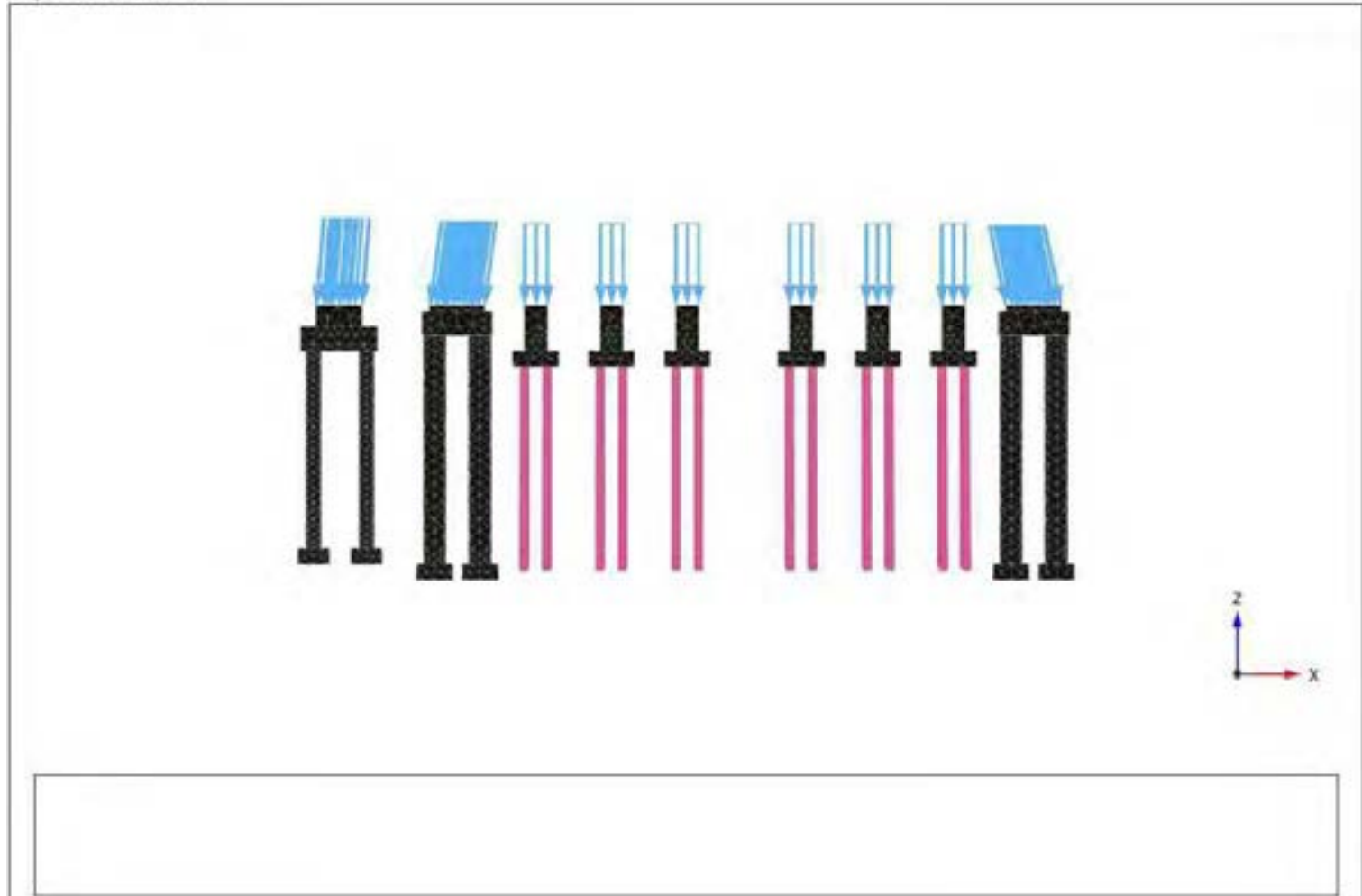

 THURBER ENGINEERING LTD.	Project description	30442-Rainbow Valley Bridge	Date	2021-06-23
	Project filename	30442-Rainbow Valley Bri ...	Step	33
		Company	Thurber Engineering Ltd	

Figure D33: Finite Element Mesh Used in the Analyses Showing Substructures – East Abutment

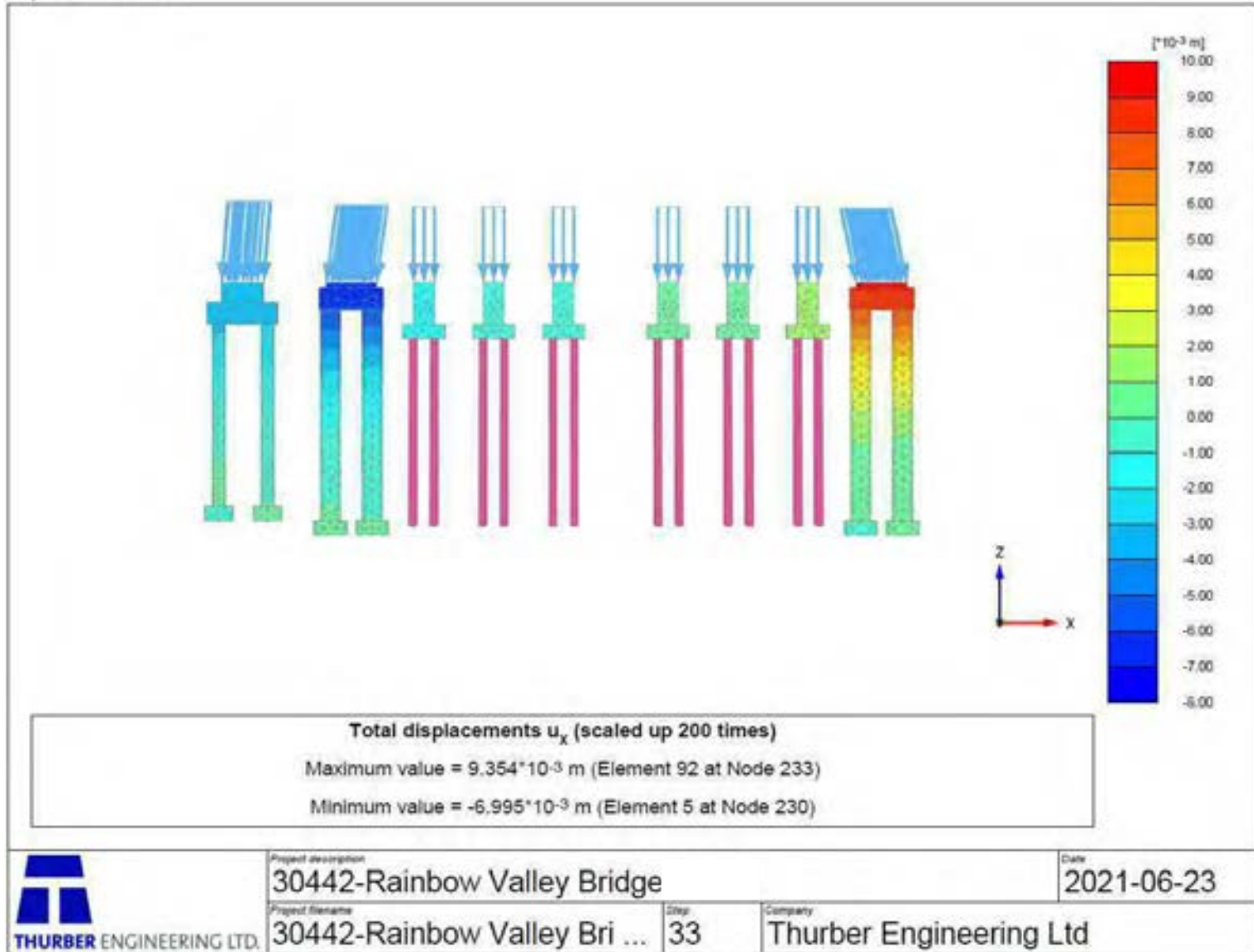

Figure D34: Contours Showing Transverse Deformation (u_x) – East Abutment

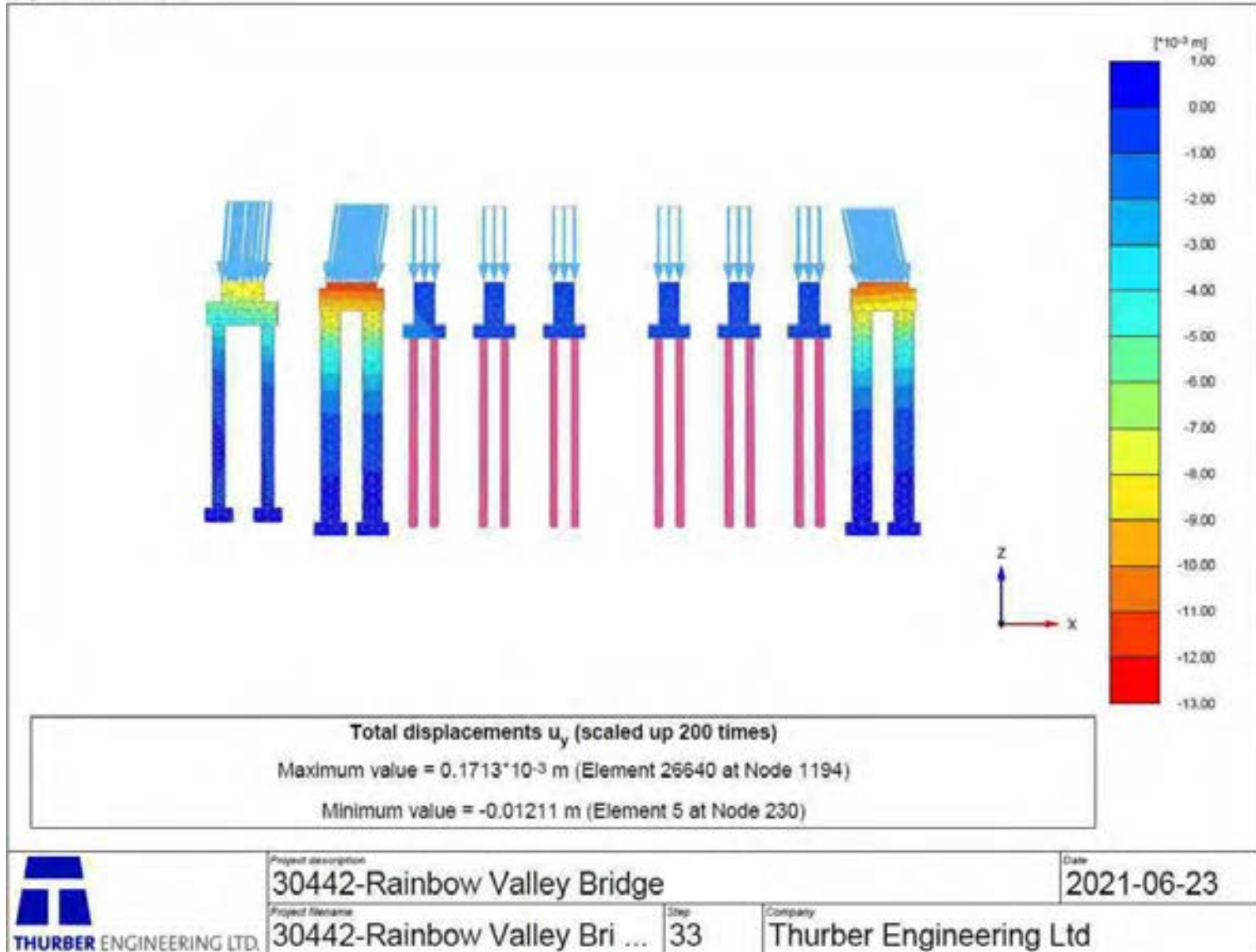

Figure D35: Contours Showing Longitudinal Deformation (u_y) – East Abutment

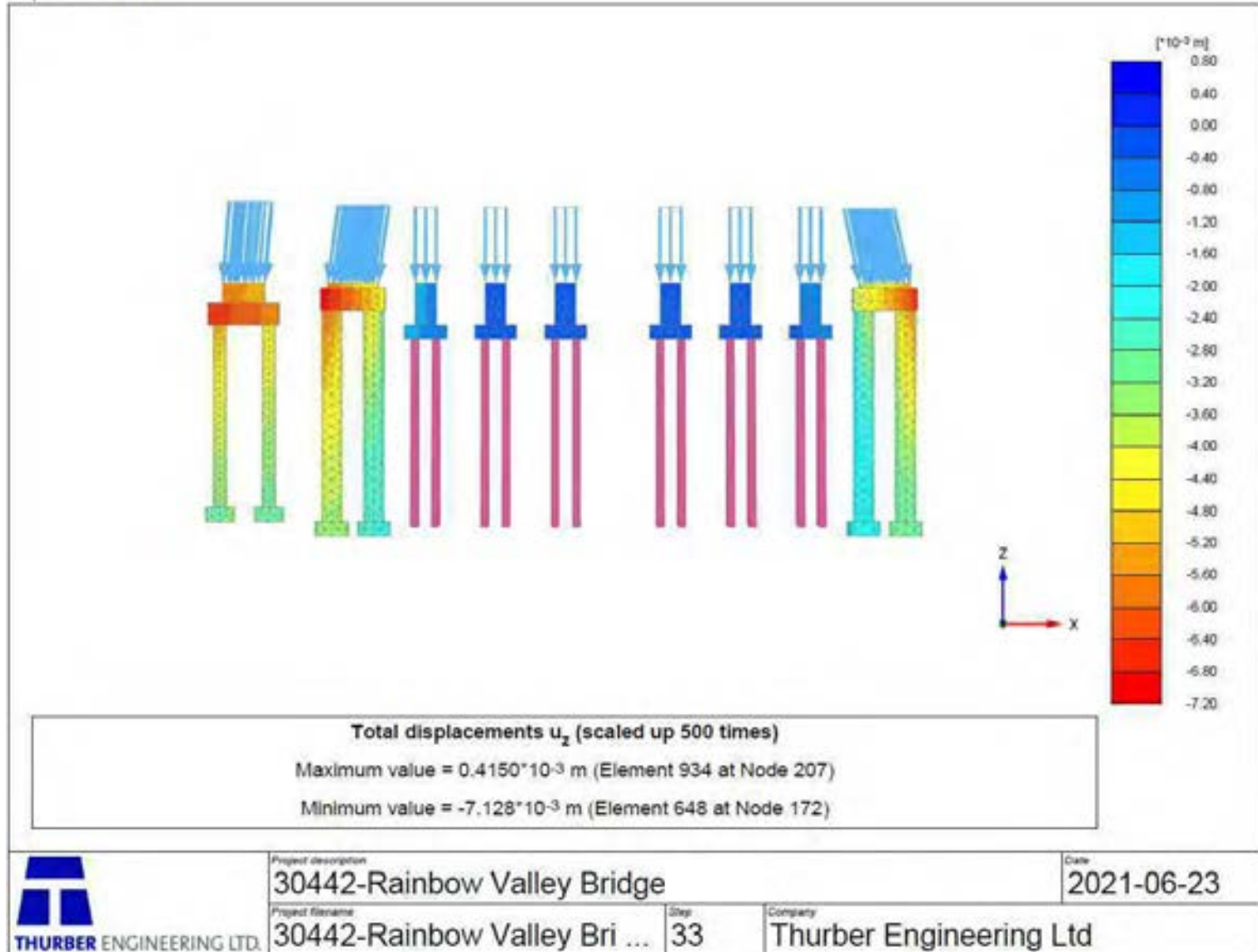

Figure D36: Contours Showing Vertical Deformation (u_z) – East Abutment

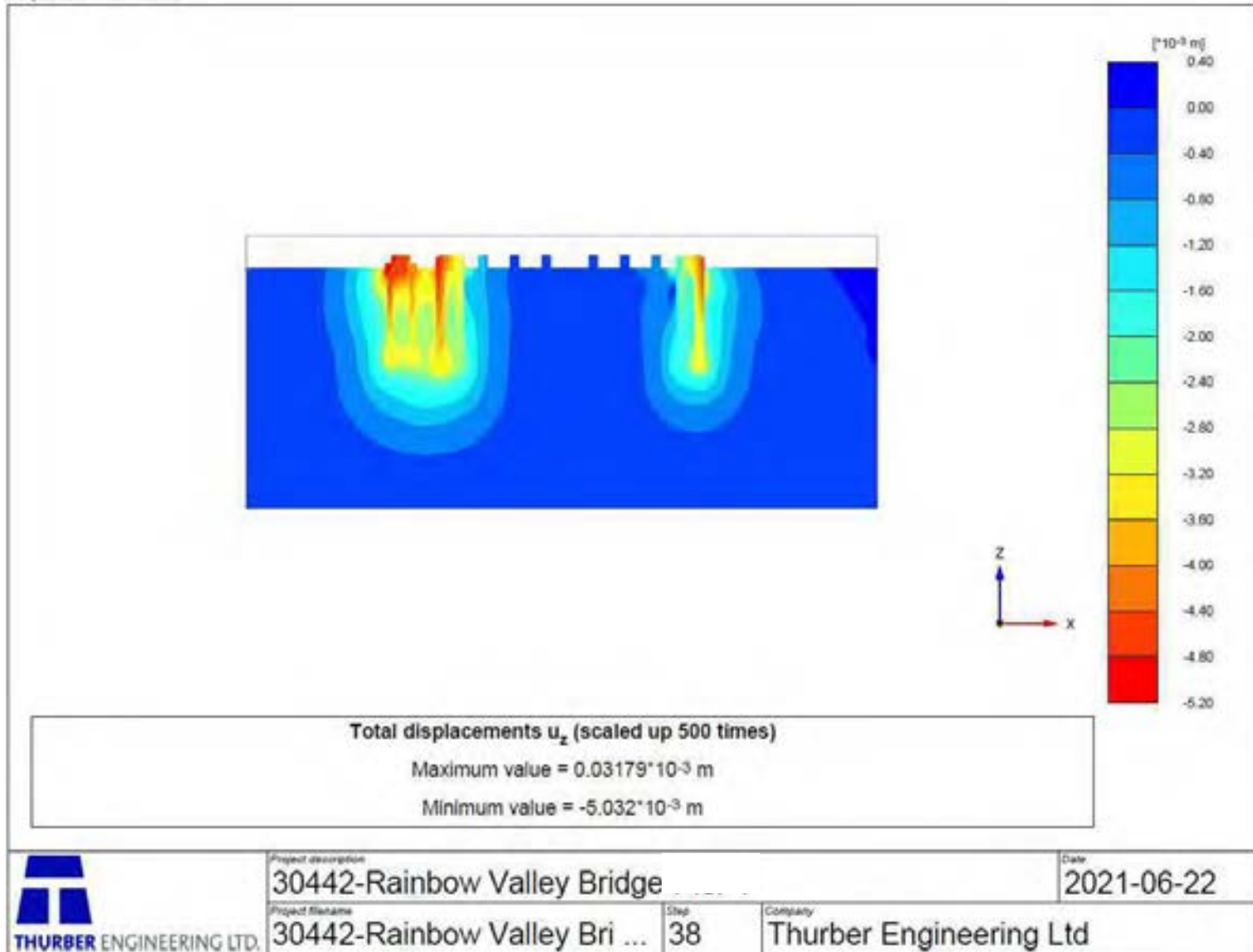

Figure D37: Contours Showing Vertical Deformation – East Abutment Cross Section



APPENDIX E

Slope Stability Analysis Results

Color	Name	Material Model	Unit Weight (kN/m ³)	Effective Cohesion (kPa)	Effective Friction Angle (°)	Phi-B (°)	Piezometric Line
Green	Clay Fill	Mohr-Coulomb	19	1	20	0	1
Pink	Clay Shale	Mohr-Coulomb	20	10	25	0	1
Purple	Clay Shale and Sandstone Fill	Mohr-Coulomb	20	5	22	0	1
Light Green	Existing Fill	Mohr-Coulomb	19	5	20	0	1
Orange	Sandstone	Bedrock (Impenetrable)					1

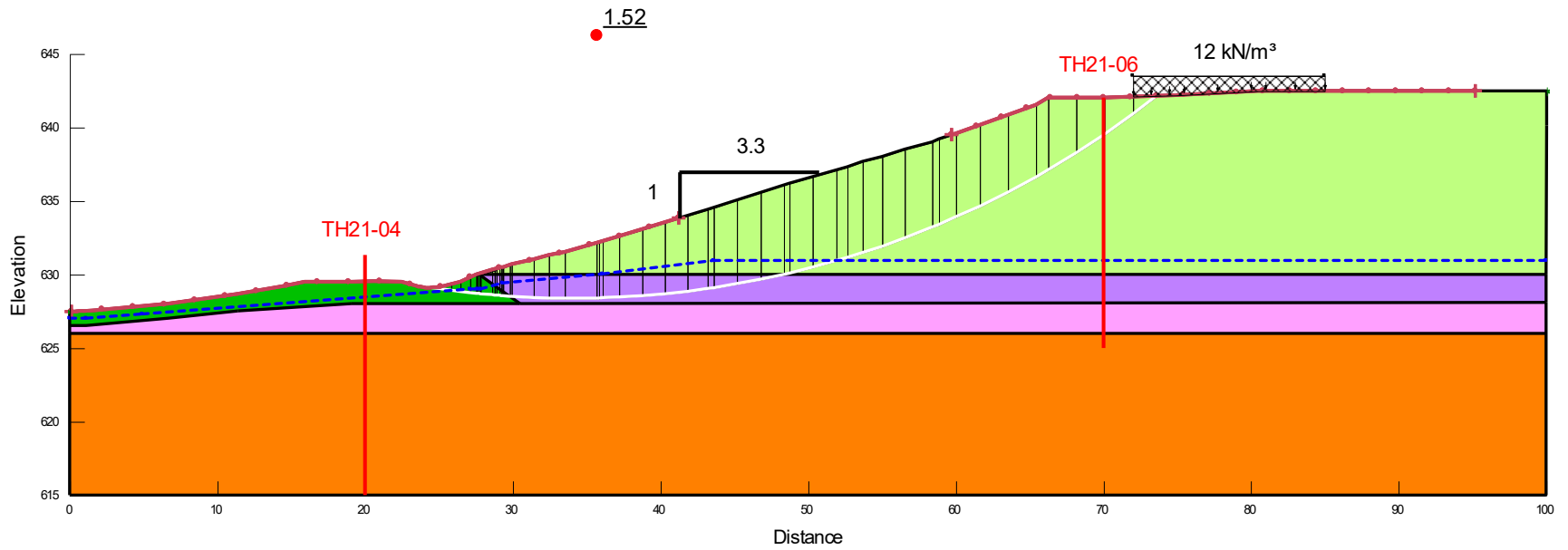

Figure E1: Section E1-E1' - Existing Conditions

Color	Name	Material Model	Unit Weight (kN/m ³)	Effective Cohesion (kPa)	Effective Friction Angle (°)	Phi-B (°)	Piezometric Line	B-bar	Add Weight
Green	Clay Fill	Mohr-Coulomb	19	5	20	0	1	0.4	No
Pink	Clay Shale	Mohr-Coulomb	20	10	25	0	1	0.6	No
Purple	Clay Shale and Sandstone Fill	Mohr-Coulomb	20	10	22	0	1	0.4	No
Light Green	Existing Fill	Mohr-Coulomb	19	10	20	0	1	0.4	No
Brown	New low to medium plastic Clay Till Fill	Mohr-Coulomb	19	5	28	0	1	0.2	Yes
Orange	Sandstone	Bedrock (Impenetrable)					1	0	No

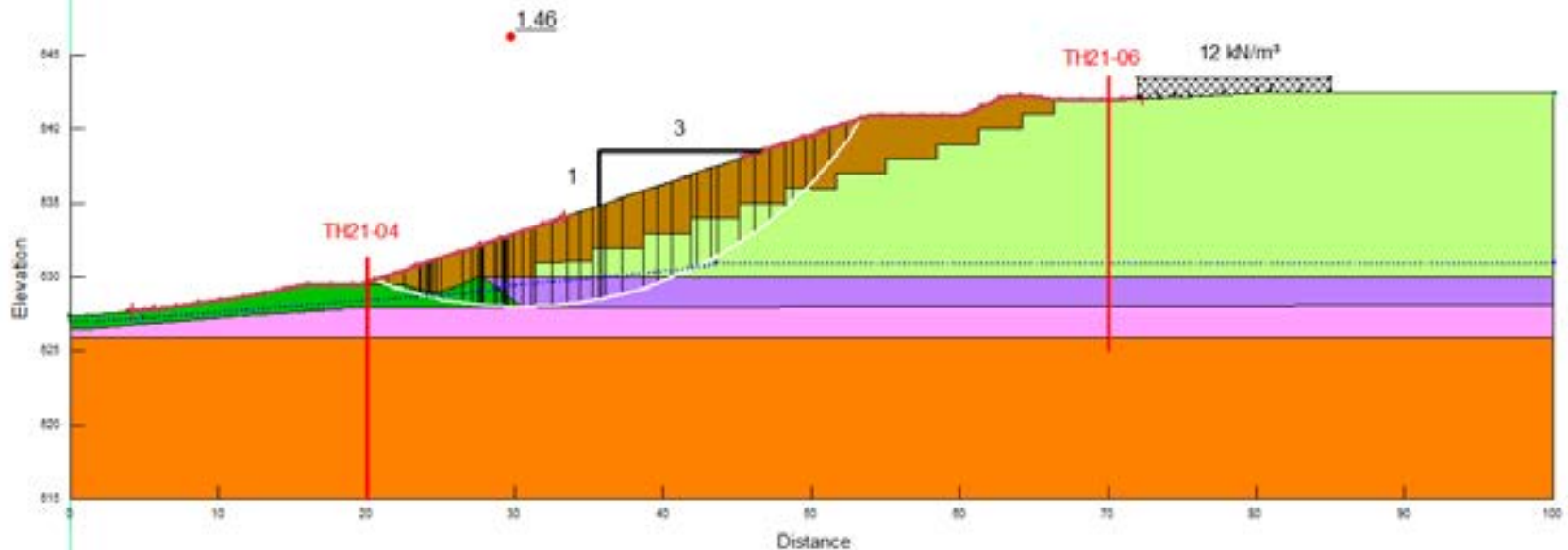

Figure E2: Section E1-E1' – Short Term Conditions

Color	Name	Material Model	Unit Weight (kN/m ³)	Effective Cohesion (kPa)	Effective Friction Angle (°)	Phi-B (°)	Piezometric Line
Green	Clay Fill	Mohr-Coulomb	19	1	20	0	1
Pink	Clay Shale	Mohr-Coulomb	20	10	25	0	1
Purple	Clay Shale and Sandstone Fill	Mohr-Coulomb	20	5	22	0	1
Light Green	Existing Fill	Mohr-Coulomb	19	5	20	0	1
Brown	New low to medium plastic Clay Till Fill	Mohr-Coulomb	19	5	28	0	1
Orange	Sandstone	Bedrock (Impenetrable)					1

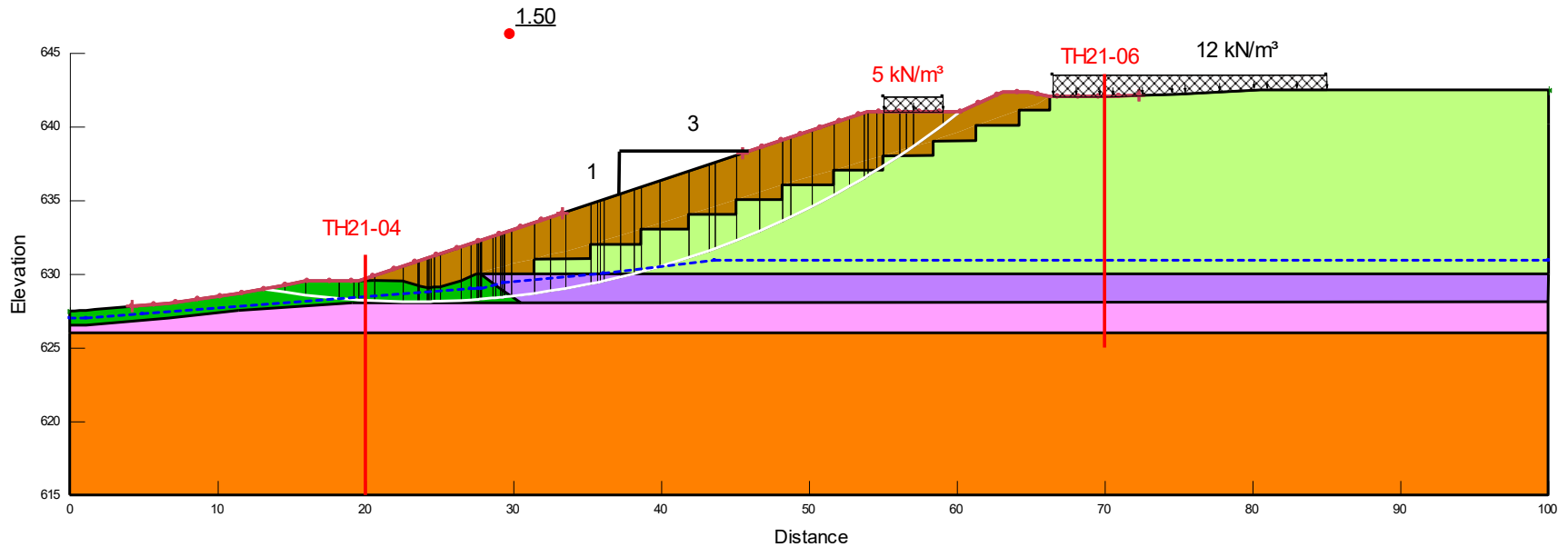

Figure E3: Section E1-E1' – Long Term Conditions

Color	Name	Material Model	Unit Weight (kNm ³)	Effective Cohesion (kPa)	Effective Friction Angle (°)	Phi-B (°)	Piezometric Line
Green	Clay Fill	Mohr-Coulomb	19	1	20	0	1
Pink	Clay Shale	Mohr-Coulomb	20	10	25	0	1
Pink	Clay Shale and Sandstone Fill	Mohr-Coulomb	20	5	22	0	1
Light Green	Existing Fill	Mohr-Coulomb	19	5	20	0	1
Yellow	Sand	Mohr-Coulomb	21	0	30	0	1
Orange	Sandstone	Bedrock (Impenetrable)					1

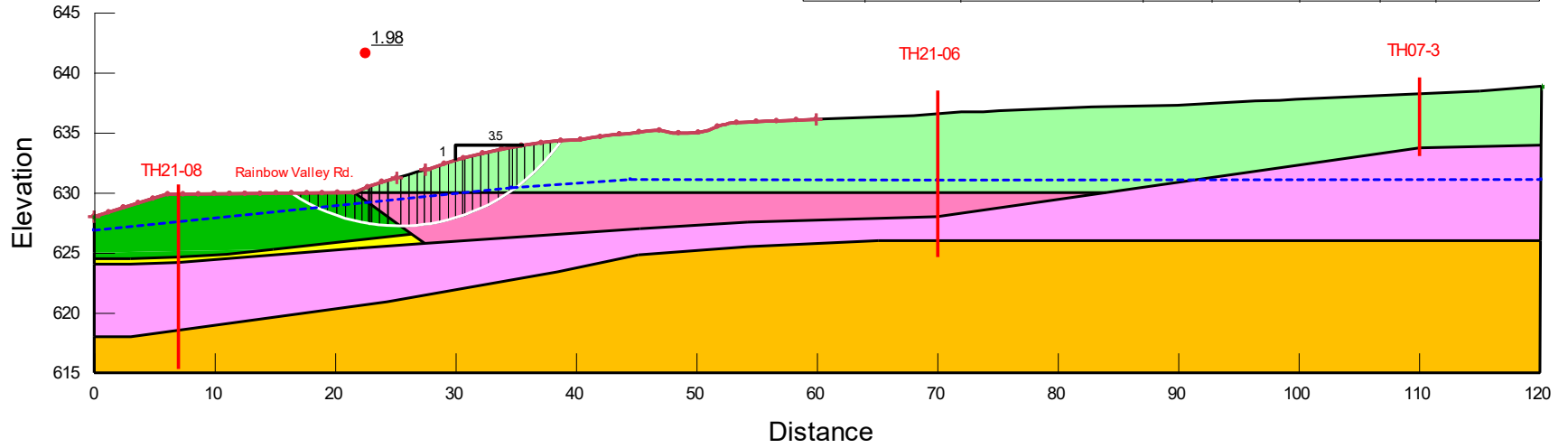

Figure E4: Section E2-E2' – Existing Conditions

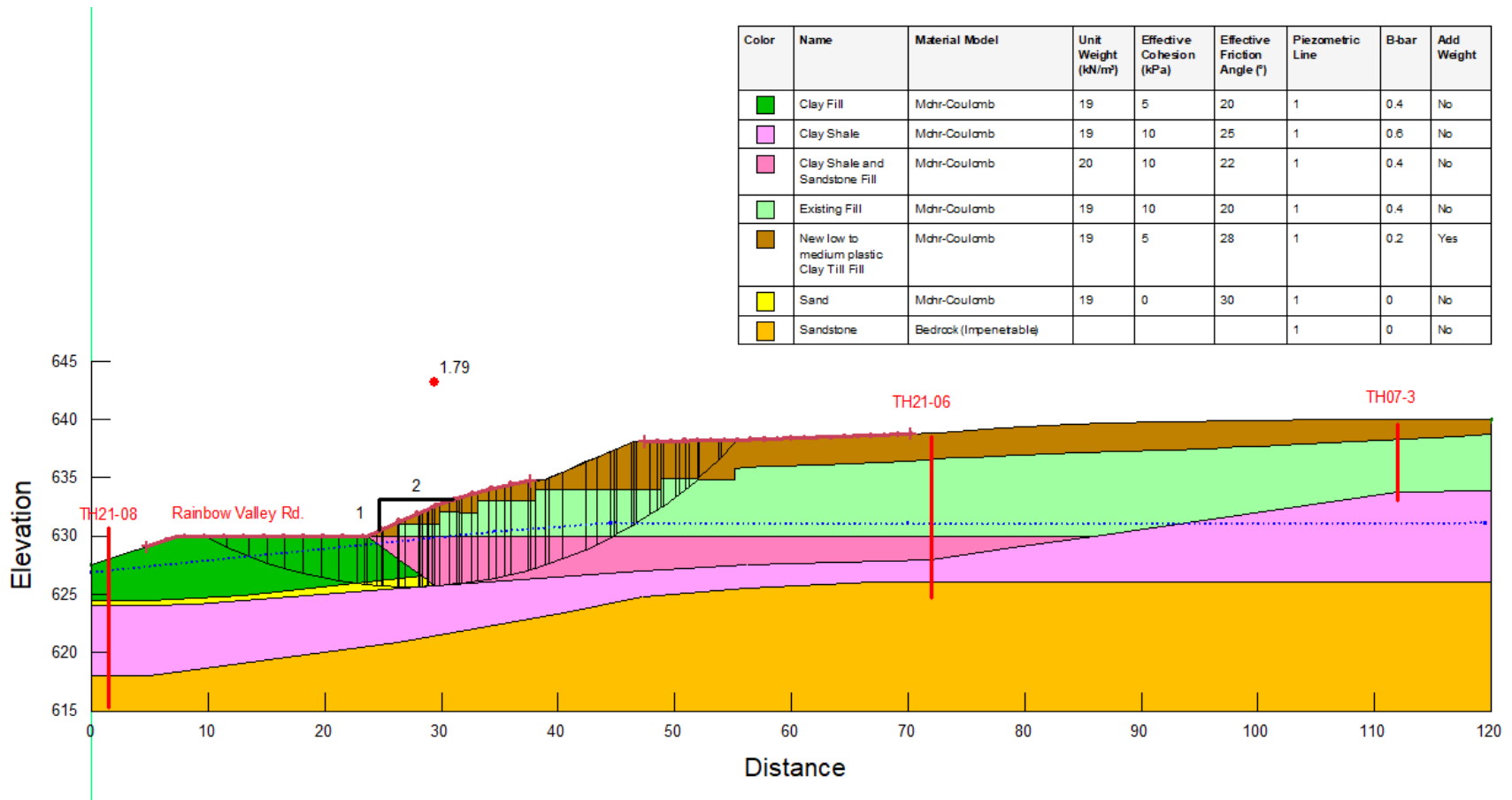

Figure E5: Section E2-E2' – Short Term Conditions

Color	Name	Material Model	Unit Weight (kN/m ³)	Effective Cohesion (kPa)	Effective Friction Angle (°)	Phi-B (°)	Piezometric Line
Green	Clay Fill	Mohr-Coulomb	19	1	20	0	1
Pink	Clay Shale	Mohr-Coulomb	19	10	25	0	1
Light Pink	Clay Shale and Sandstone Fill	Mohr-Coulomb	20	5	22	0	1
Light Green	Existing Fill	Mohr-Coulomb	19	5	20	0	1
Brown	New low to medium plastic Clay Till Fill	Mohr-Coulomb	19	5	28	0	1
Yellow	Sand	Mohr-Coulomb	19	0	30	0	1
Orange	Sandstone	Bedrock (Impenetrable)					1

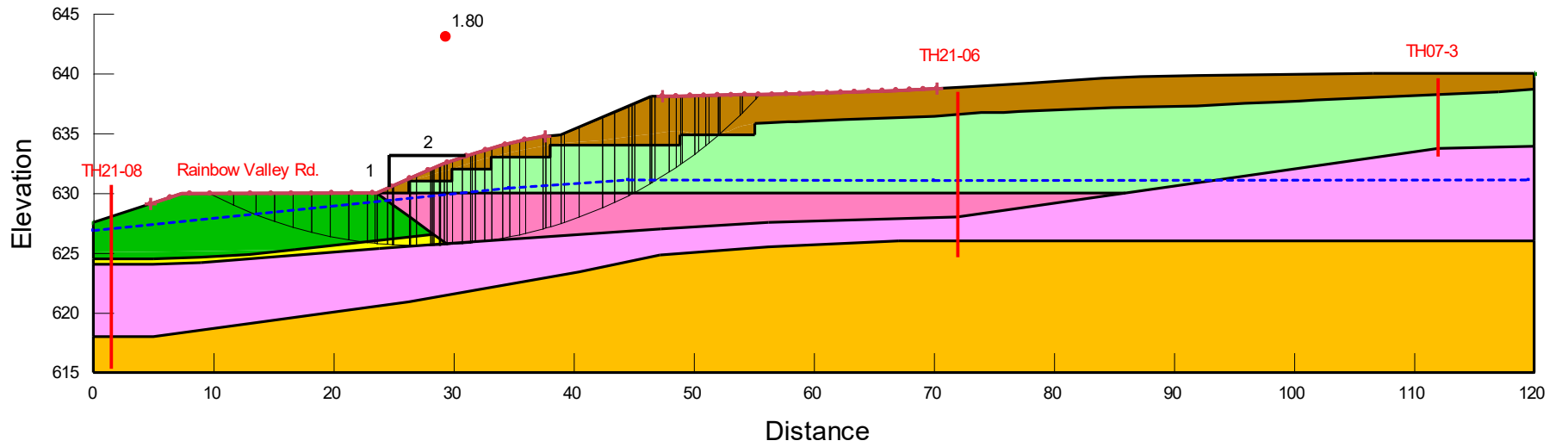

Figure E6: Section E2-E2' – Long Term Conditions

Color	Name	Material Model	Unit Weight (kNm ³)	Effective Cohesion (kPa)	Effective Friction Angle (°)	Phi-B (°)	Piezometric Line
Green	Clay Fill	Mohr-Coulomb	19	1	20	0	1
Pink	Clay Shale	Mohr-Coulomb	20	10	25	0	1
Light Pink	Clay Shale and Sandstone Fill	Mohr-Coulomb	20	5	22	0	1
Light Green	Existing Fill	Mohr-Coulomb	19	5	20	0	1
Yellow	Sand	Mohr-Coulomb	19	0	30	0	1
Orange	Sandstone	Bedrock (Impenetrable)					1

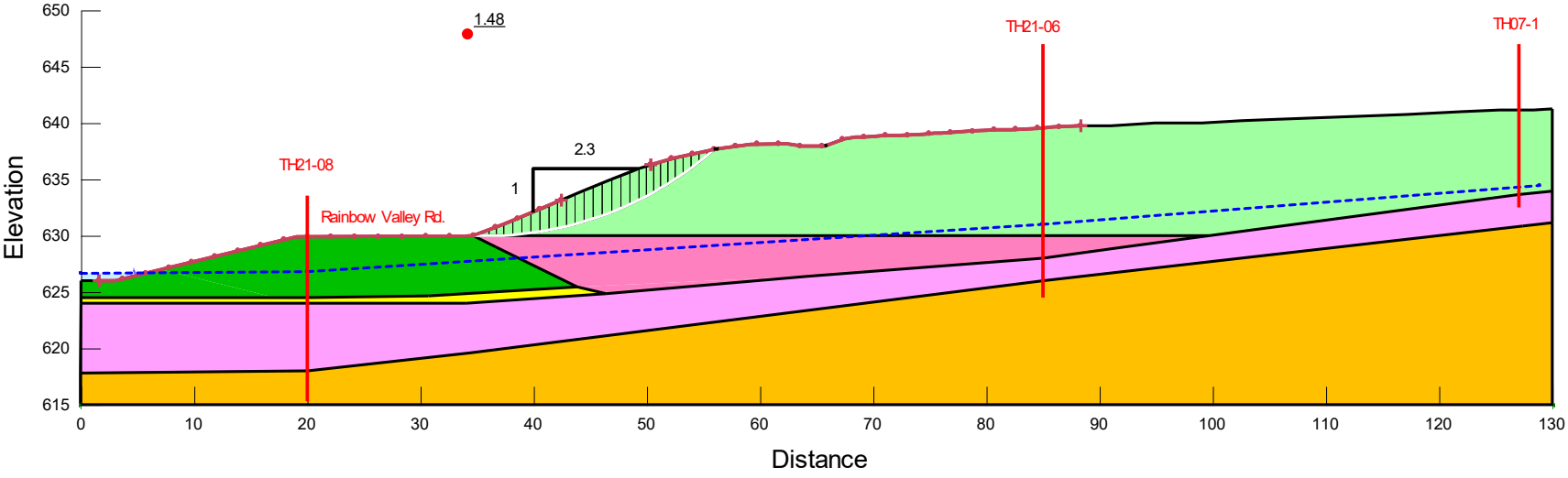

Figure E7: Section E3-E3' – Existing Conditions

Color	Name	Material Model	Unit Weight (kN/m ³)	Effective Cohesion (kPa)	Effective Friction Angle (°)	Phi-B (°)	Piezometric Line	B-bar	Add Weight
Green	Clay Fill	Mohr-Coulomb	19	5	20	0	1	0.4	No
Pink	Clay Shale	Mohr-Coulomb	20	10	25	0	1	0.6	No
Light Pink	Clay Shale and Sandstone Fill	Mohr-Coulomb	20	10	22	0	1	0.4	No
Light Green	Existing Fill	Mohr-Coulomb	19	10	20	0	1	0.4	No
Brown	New low to medium plastic Clay Till Fill	Mohr-Coulomb	19	5	28	0	1	0.2	Yes
Yellow	Sand	Mohr-Coulomb	19	0	30	0	1	0	No
Orange	Sandstone	Bedrock (Impenetrable)					1	0	No

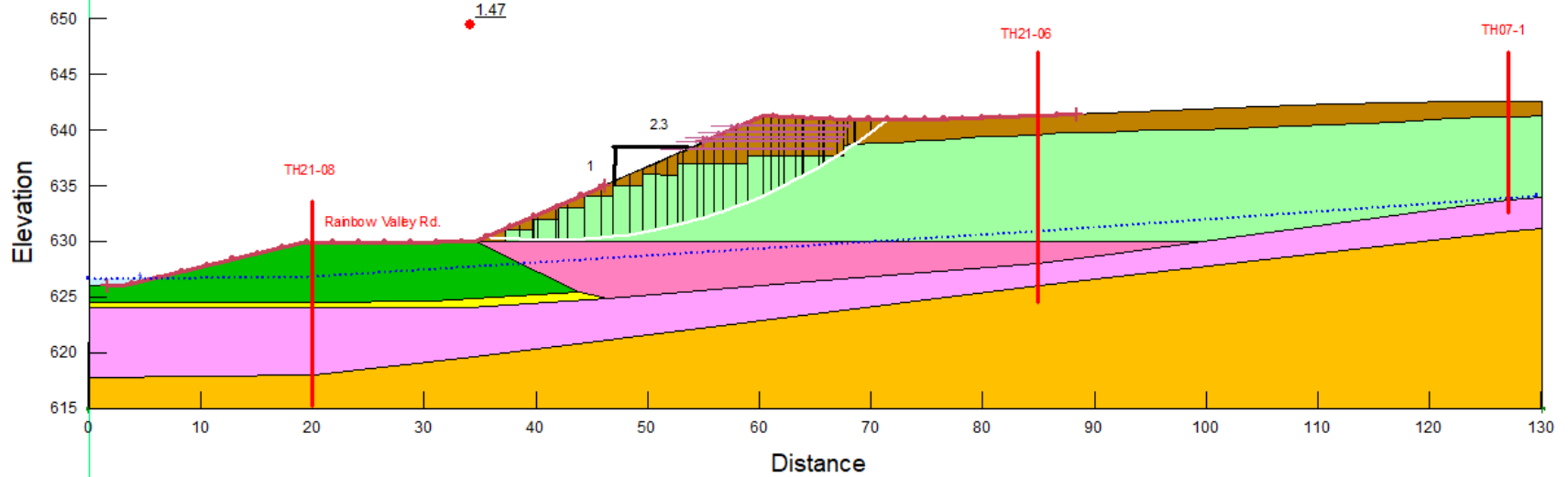

Figure E8: Section E3-E3' – Short Term Conditions – With 5 layers of geogrid

Color	Name	Material Model	Unit Weight (kNm ³)	Effective Cohesion (kPa)	Effective Friction Angle (°)	Phi-B (°)	Piezometric Line
Green	Clay Fill	Mohr-Coulomb	19	1	20	0	1
Pink	Clay Shale	Mohr-Coulomb	20	10	25	0	1
Light Pink	Clay Shale and Sandstone Fill	Mohr-Coulomb	20	5	22	0	1
Light Green	Existing Fill	Mohr-Coulomb	19	5	20	0	1
Brown	New low to medium plastic Clay Till Fill	Mohr-Coulomb	19	5	28	0	1
Yellow	Sand	Mohr-Coulomb	19	0	30	0	1
Orange	Sandstone	Bedrock (Impenetrable)					1

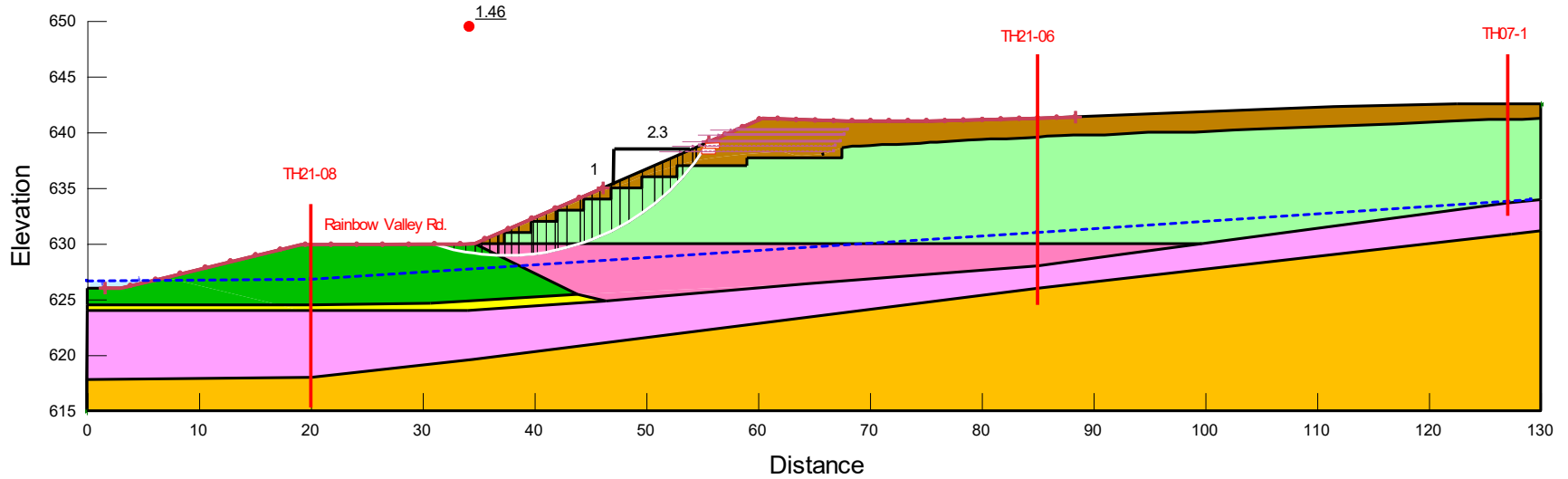

Figure E9: Section E3-E3' – Long Term Conditions – With 5 layers of geogrid

Color	Name	Material Model	Unit Weight (kN/m ³)	Effective Cohesion (kPa)	Effective Friction Angle (°)	Piezometric Line
Green	Clay Fill	Mohr-Coulomb	19	1	20	1
Pink	Clay Shale	Mohr-Coulomb	20	10	25	1
Light Pink	Clay Shale and Sandstone Fill	Mohr-Coulomb	20	5	22	1
Light Green	Existing Fill	Mohr-Coulomb	19	5	20	1
Yellow	Sandstone	Bedrock (Impenetrable)				1

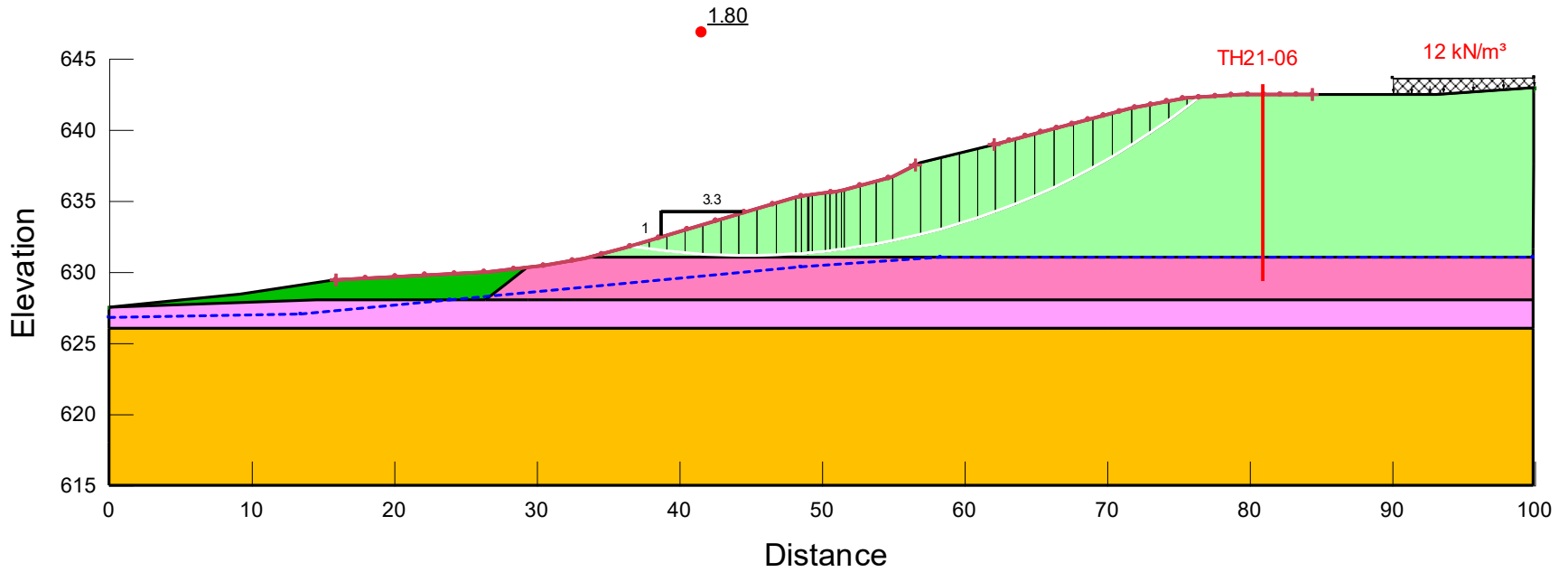

Figure E10: Section E4-E4' – Existing Conditions

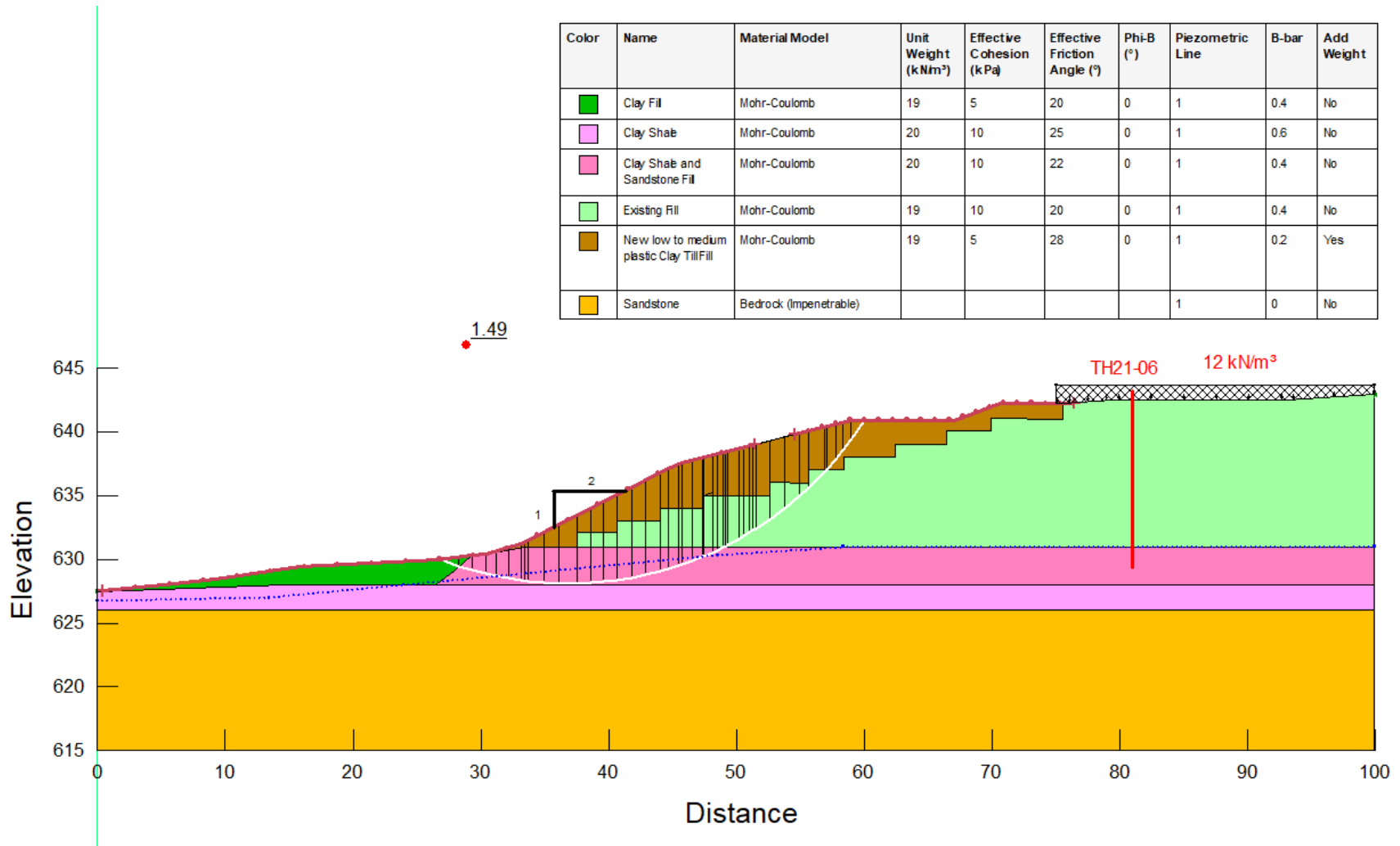

Figure E11: Section E4-E4' – Short Term Conditions

Color	Name	Material Model	Unit Weight (kN/m ³)	Effective Cohesion (kPa)	Effective Friction Angle (°)	Phi-B (°)	Piezometric Line
Green	Clay Fill	Mohr-Coulomb	19	1	20	0	1
Pink	Clay Shale	Mohr-Coulomb	20	10	25	0	1
Light Green	Clay Shale and Sandstone Fill	Mohr-Coulomb	20	5	22	0	1
Light Green	Existing Fill	Mohr-Coulomb	19	5	20	0	1
Brown	New low to medium plastic Clay Till Fill	Mohr-Coulomb	19	5	28	0	1
Yellow	Sandstone	Bedrock (Impenetrable)					1

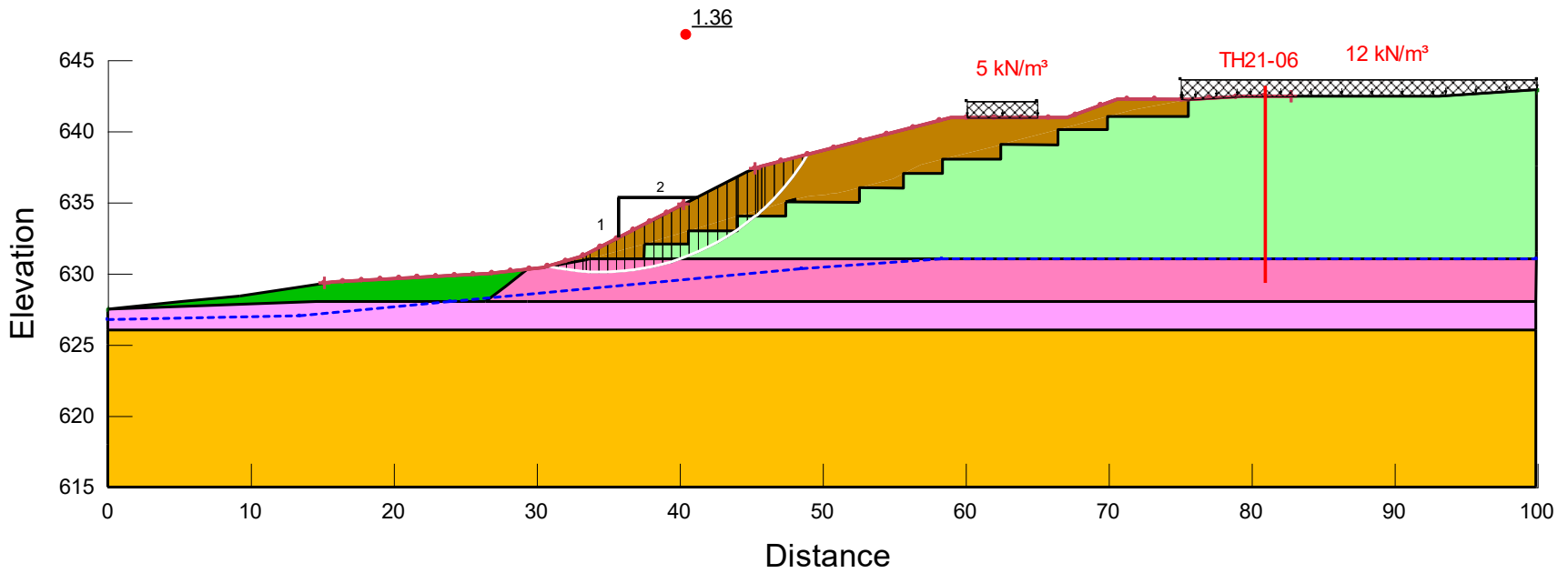

Figure E12: Section E4-E4' – Long Term Conditions

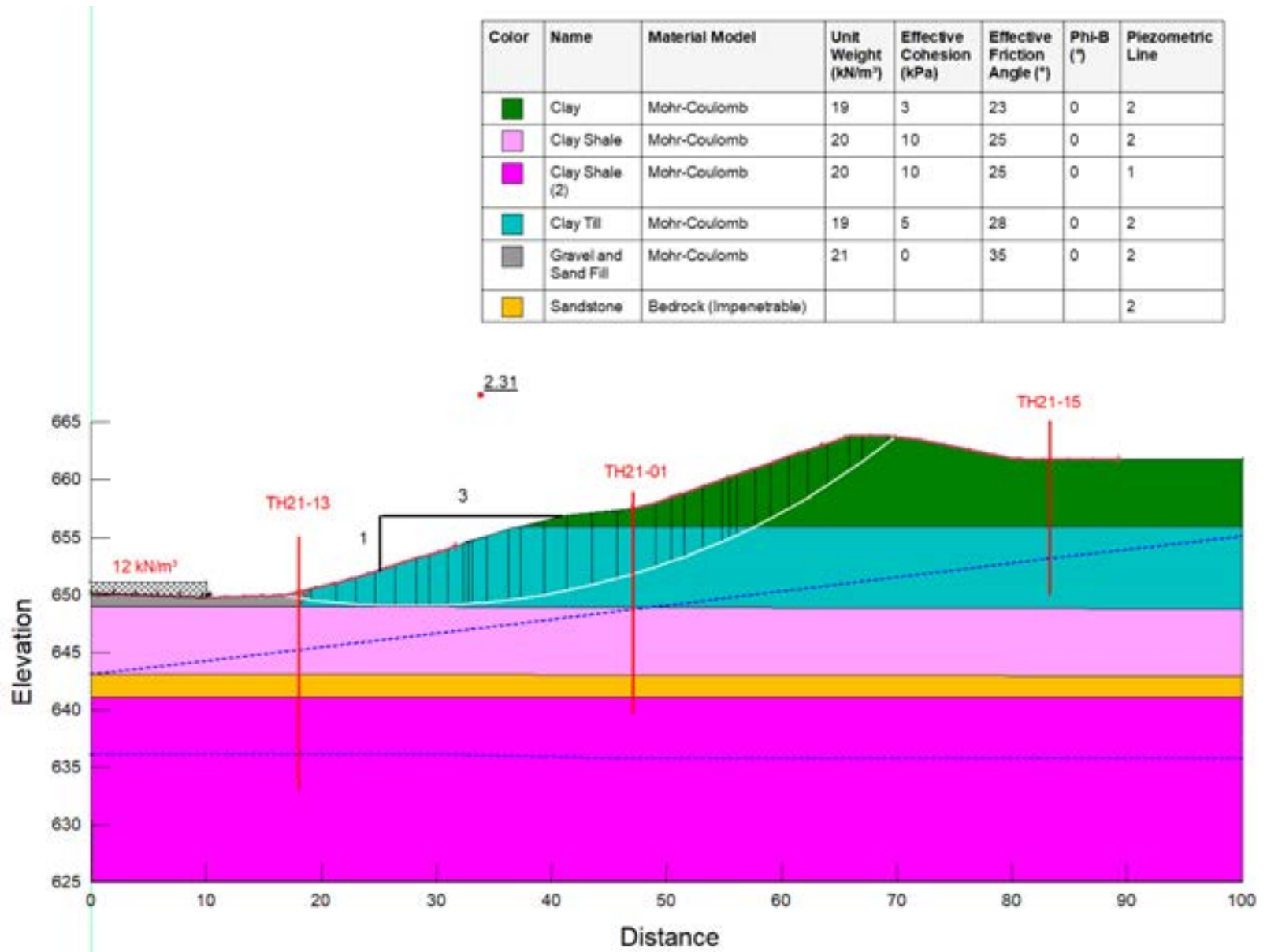

Figure E13: Section W1-W1' – Existing Conditions

Color	Name	Material Model	Unit Weight (kN/m ³)	Effective Cohesion (kPa)	Effective Friction Angle (°)	Phi-B (°)	Piezometric Line
Green	Clay	Mohr-Coulomb	19	3	23	0	2
Pink	Clay Shale	Mohr-Coulomb	20	10	25	0	2
Magenta	Clay Shale (2)	Mohr-Coulomb	20	10	25	0	1
Cyan	Clay Till	Mohr-Coulomb	19	5	28	0	2
Grey	Gravel and Sand Fill	Mohr-Coulomb	21	0	35	0	2
Yellow	Sandstone	Bedrock (Impenetrable)					2

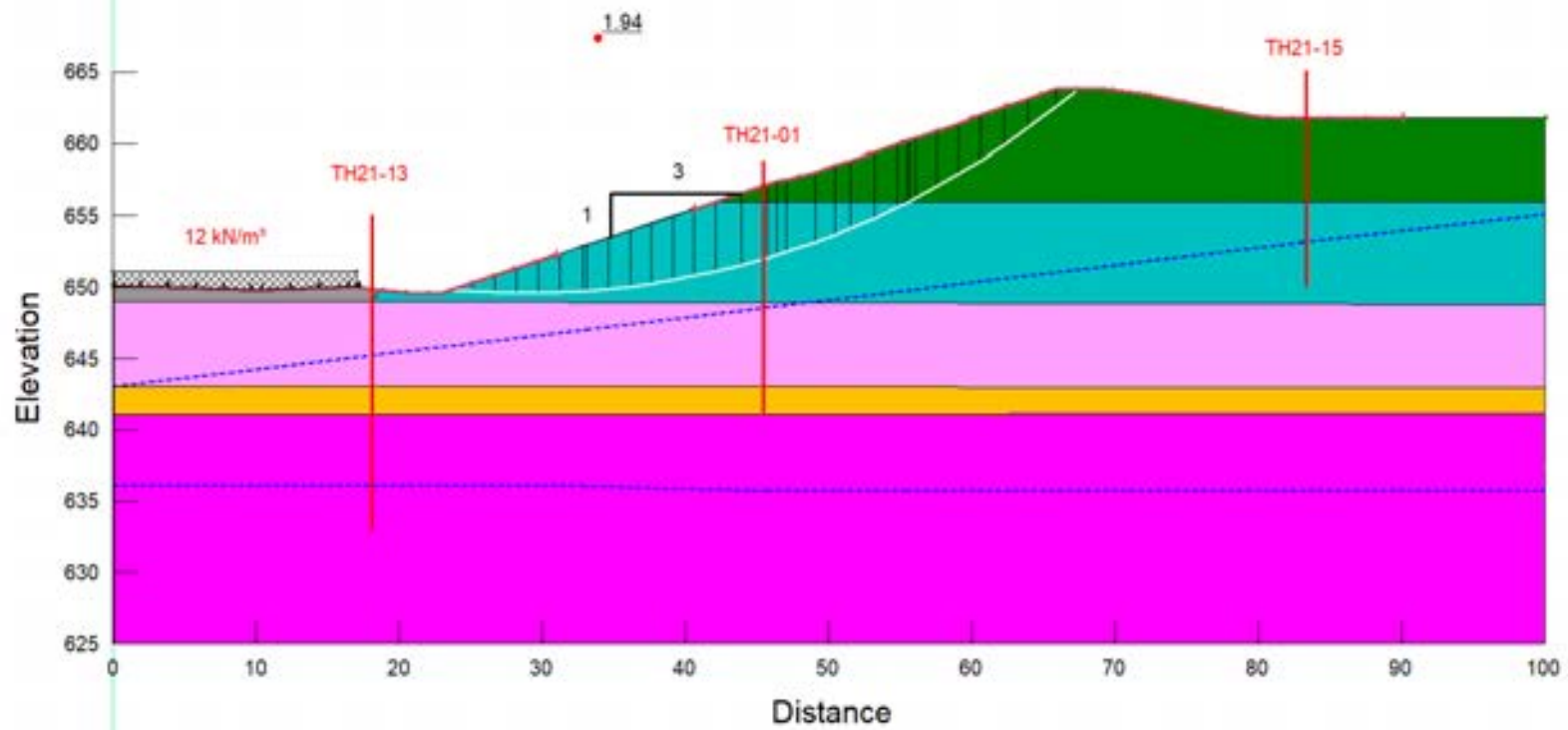

Figure E14: Section W1-W1' – Cut Slope

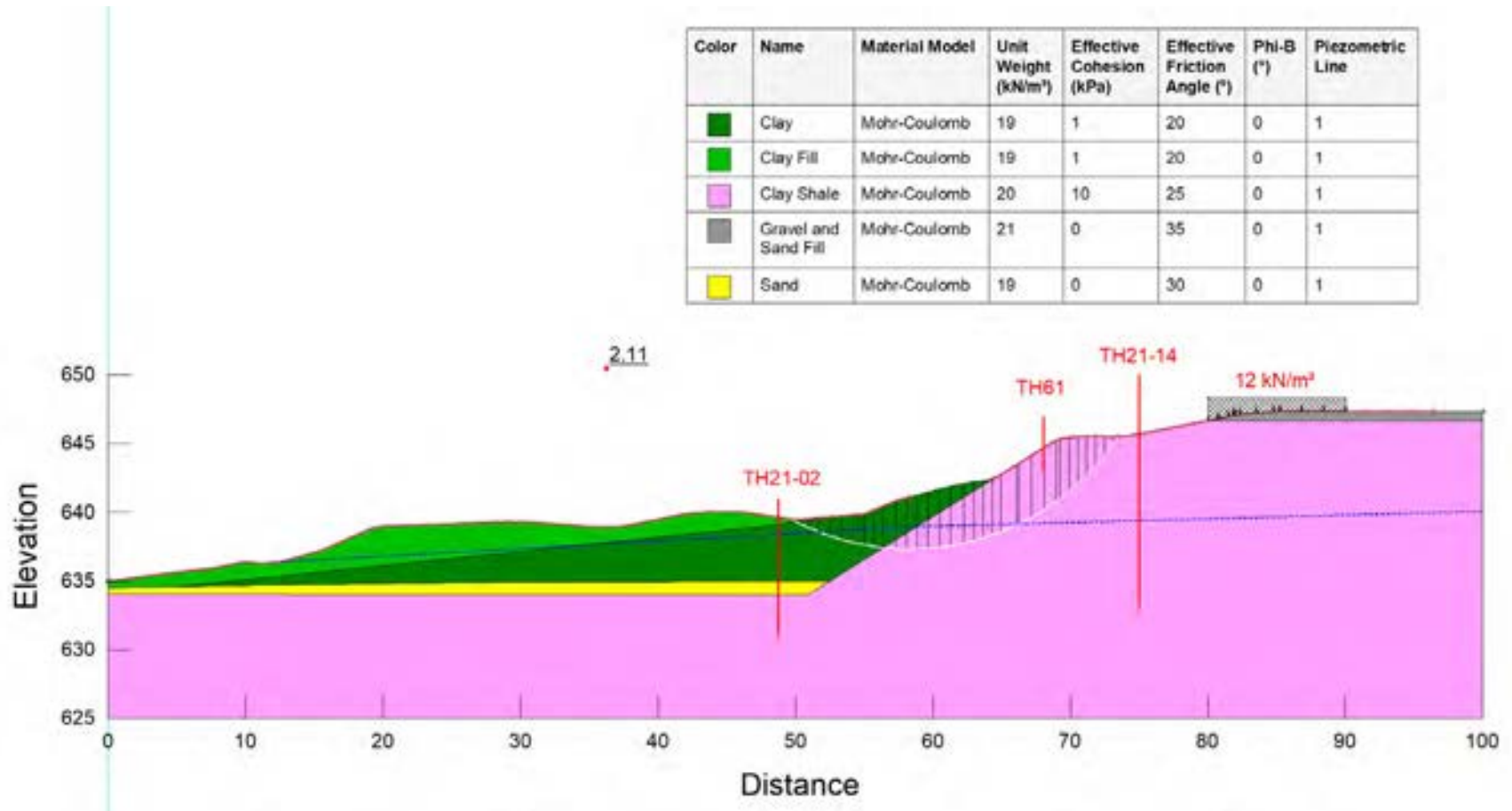

Figure E15: Section W2-W2' – Existing Conditions

Color	Name	Material Model	Unit Weight (kN/m ³)	Effective Cohesion (kPa)	Effective Friction Angle (°)	Phi-B (°)	Piezometric Line	B-bar	Add Weight
Green	Clay	Mohr-Coulomb	19	5	20	0	1	0.4	No
Light Green	Clay Fill	Mohr-Coulomb	19	5	20	0	1	0.4	No
Pink	Clay Shale	Mohr-Coulomb	20	10	25	0	1	0.6	No
Grey	Gravel and Sand Fill	Mohr-Coulomb	21	0	35	0	1	0	No
Brown	New low to medium plastic Clay Till Fill	Mohr-Coulomb	19	5	28	0	1	0.2	Yes
Yellow	Sand	Mohr-Coulomb	19	0	30	0	1	0	No

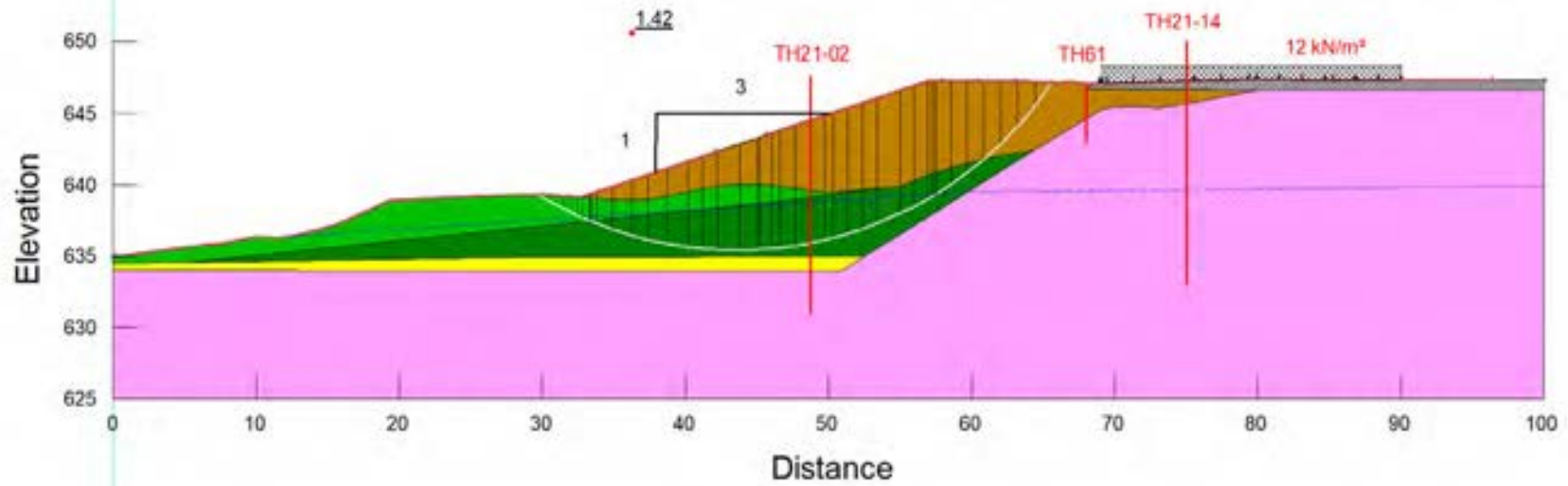

Figure E16: Section W2-W2' – Short Term Conditions

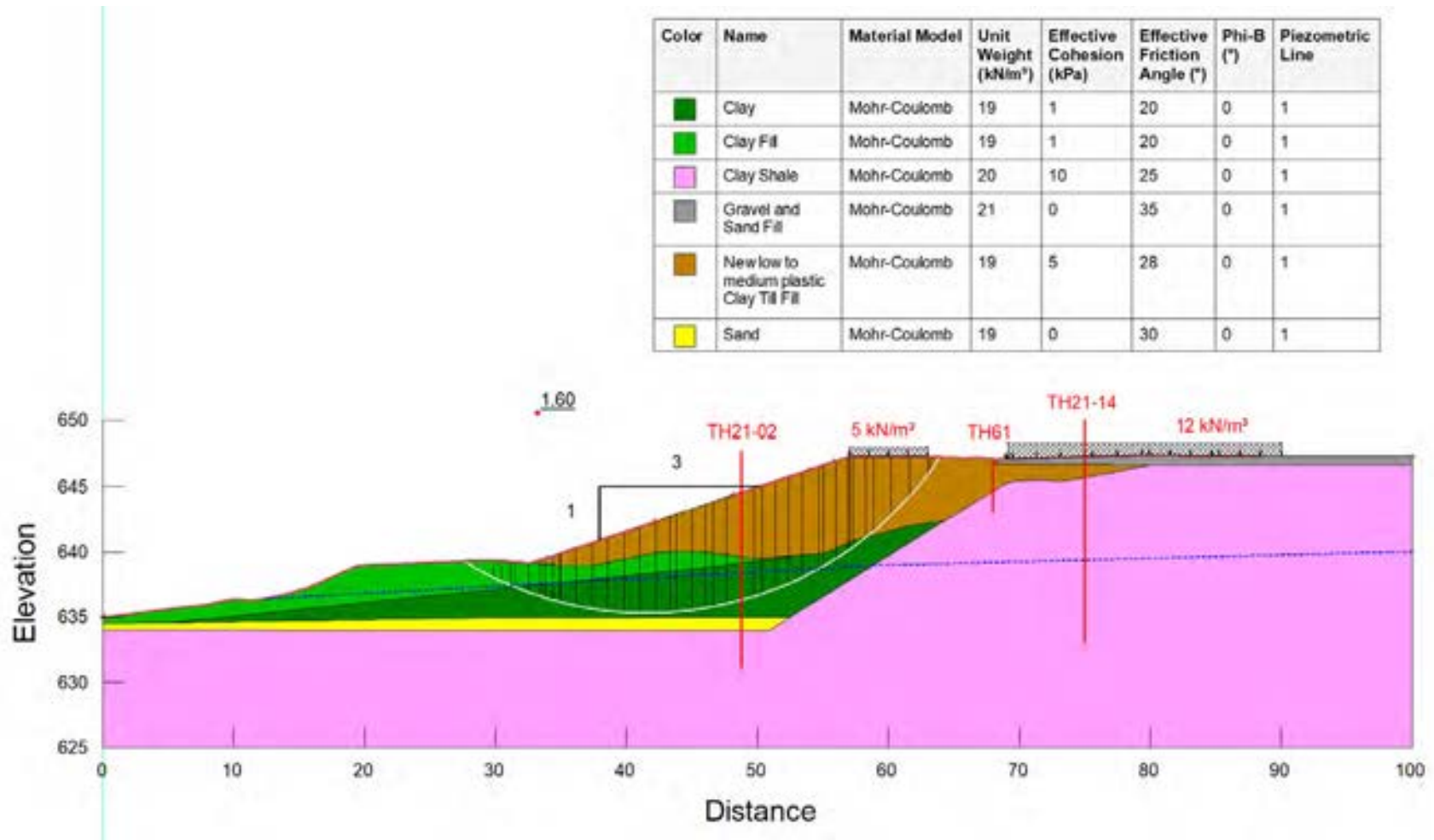

Figure E17: Section W2-W2' - Long Term Conditions

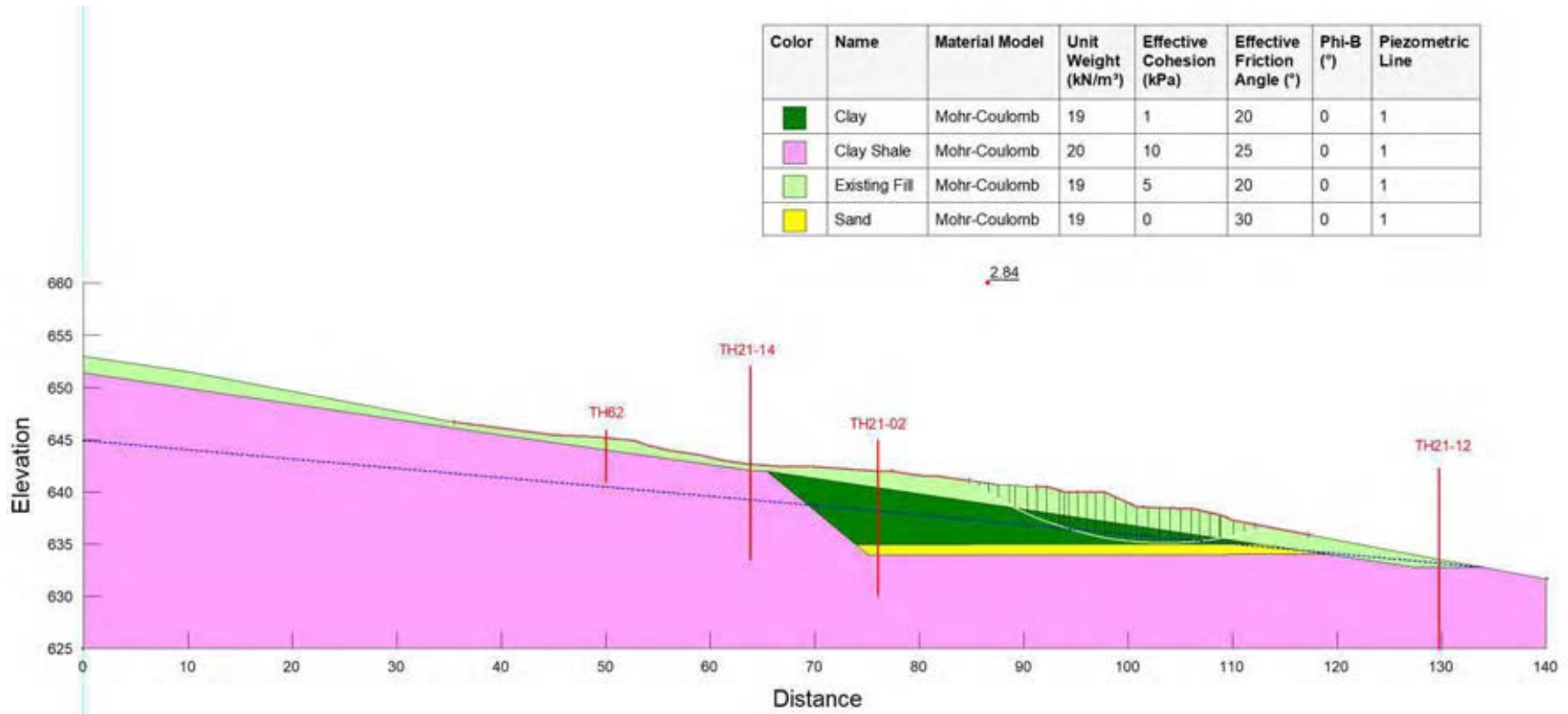

Figure E18: Section W3-W3' – Existing Conditions

Color	Name	Material Model	Unit Weight (kN/m ³)	Effective Cohesion (kPa)	Effective Friction Angle (°)	Phi-B (°)	Piezometric Line	B-bar	Add Weight
Green	Clay	Mohr-Coulomb	19	5	20	0	1	0.4	No
Pink	Clay Shale	Mohr-Coulomb	20	10	25	0	1	0.6	No
Light Green	Existing Fill	Mohr-Coulomb	19	10	20	0	1	0.4	No
Brown	New low to medium plastic Clay Till Fill	Mohr-Coulomb	19	5	28	0	1	0.2	Yes
Yellow	Sand	Mohr-Coulomb	19	0	30	0	1	0	No

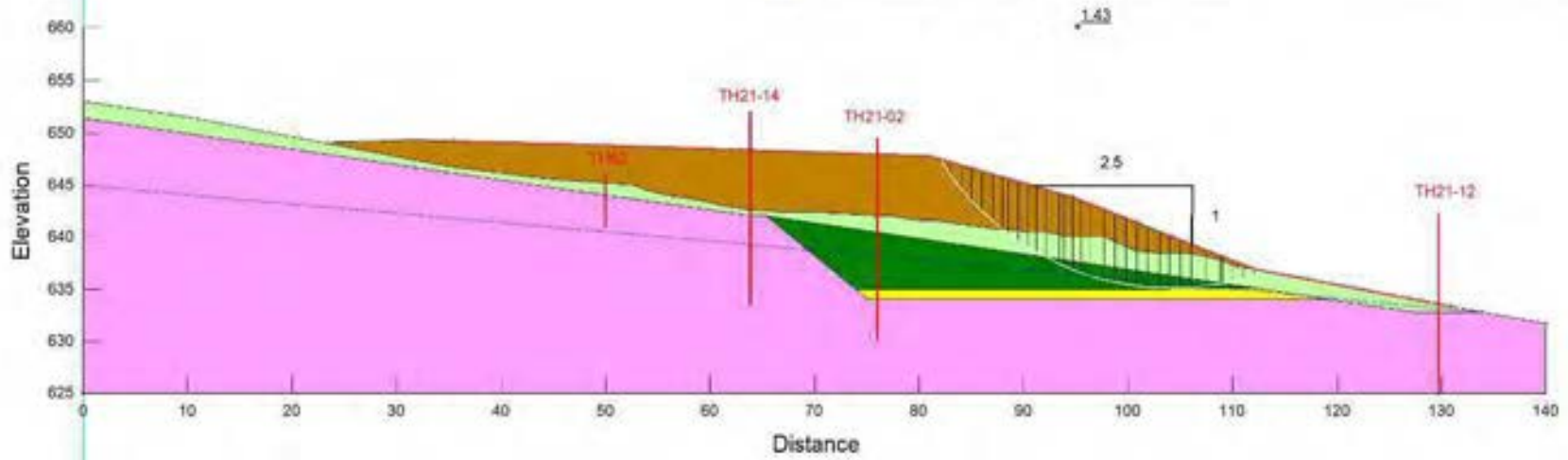

Figure E19: Section W3-W3' – Short Term Conditions

Color	Name	Material Model	Unit Weight (kN/m ³)	Effective Cohesion (kPa)	Effective Friction Angle (°)	Phi-B (°)	Piezometric Line
Green	Clay	Mohr-Coulomb	19	1	20	0	1
Pink	Clay Shale	Mohr-Coulomb	20	10	25	0	1
Light Green	Existing Fill	Mohr-Coulomb	19	5	20	0	1
Brown	New low to medium plastic Clay Till Fill	Mohr-Coulomb	19	5	28	0	1
Yellow	Sand	Mohr-Coulomb	19	0	30	0	1

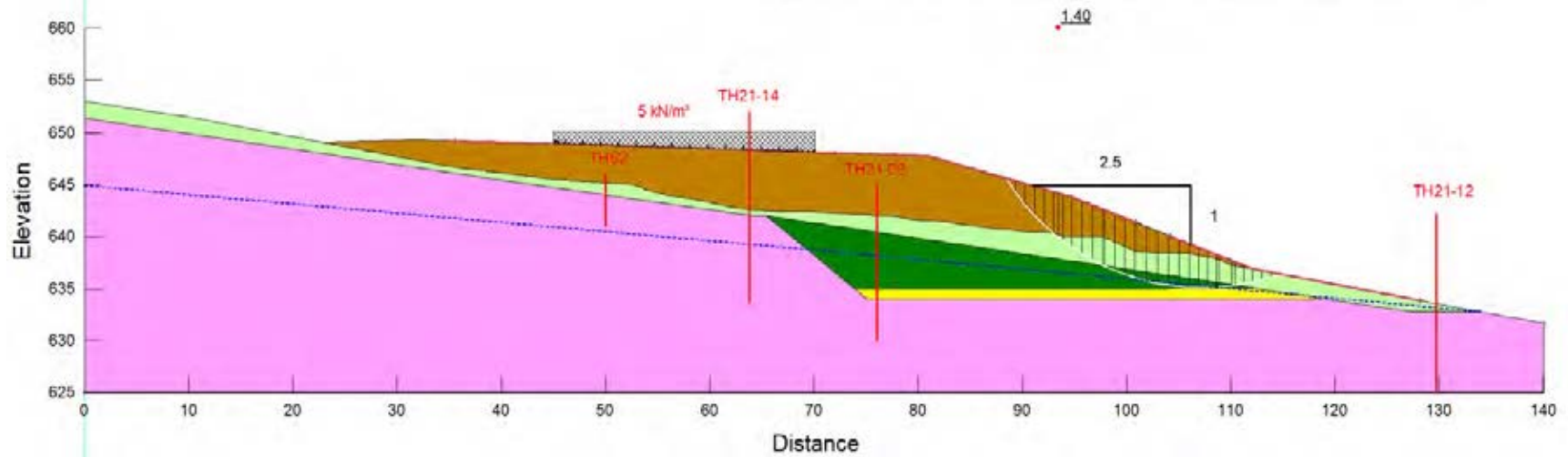

Figure E20: Section W3-W3' – Long Term Conditions

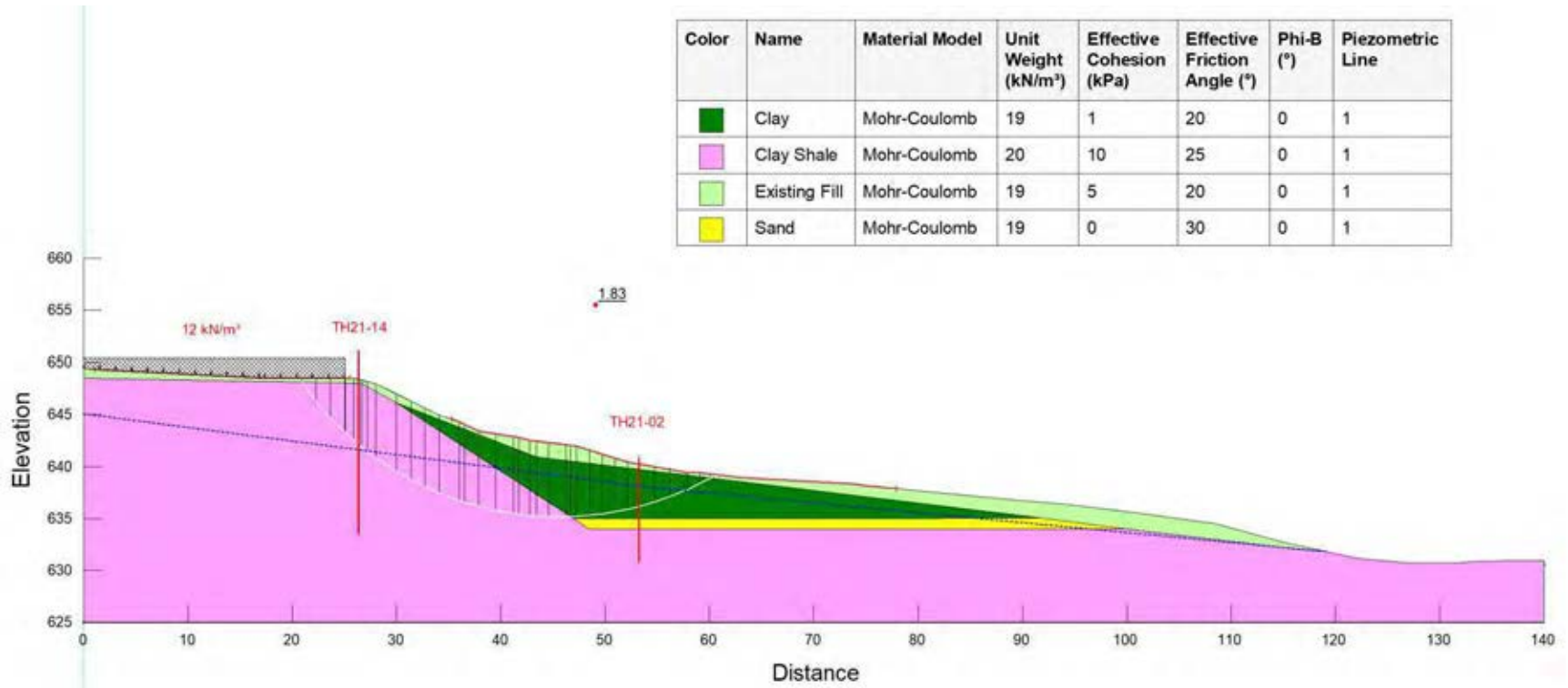

Figure E21: Section W4-W4' – Existing Conditions

Color	Name	Material Model	Unit Weight (kN/m ³)	Effective Cohesion (kPa)	Effective Friction Angle (°)	Phi-B (°)	Piezometric Line	B-bar	Add Weight
Green	Clay	Mohr-Coulomb	19	5	20	0	1	0.4	No
Pink	Clay Shale	Mohr-Coulomb	20	10	25	0	1	0.6	No
Light Green	Existing Fill	Mohr-Coulomb	19	10	20	0	1	0.4	No
Brown	New low to medium plastic Clay Till Fill	Mohr-Coulomb	19	5	28	0	1	0.2	Yes
Yellow	Sand	Mohr-Coulomb	19	0	30	0	1	0	No

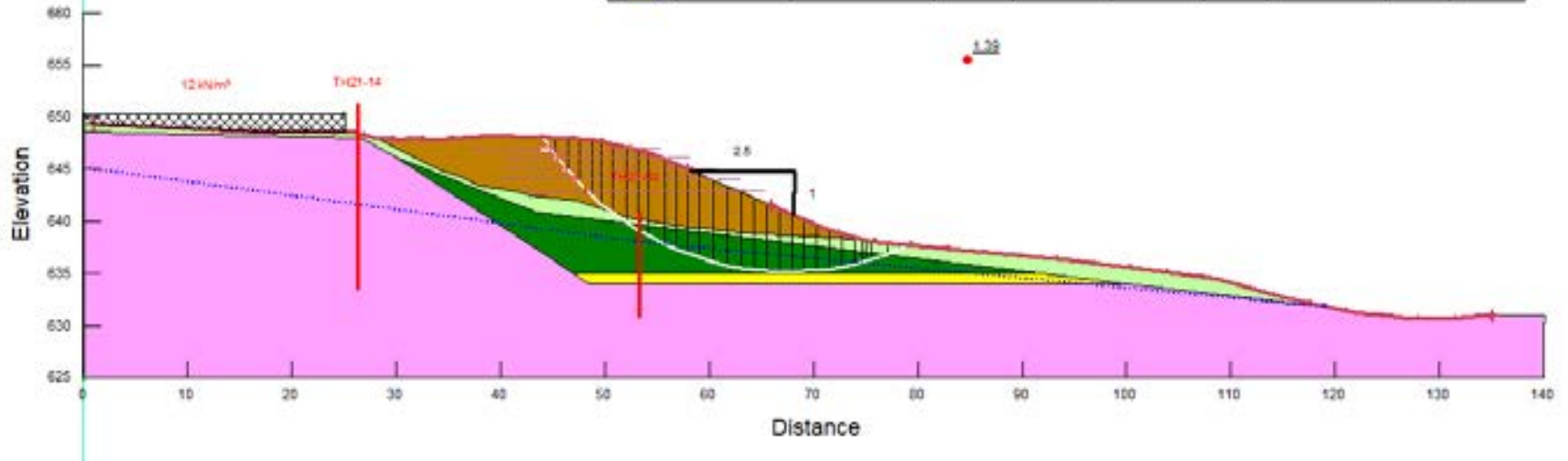

Figure E22: Section W4-W4' – Short Term Conditions

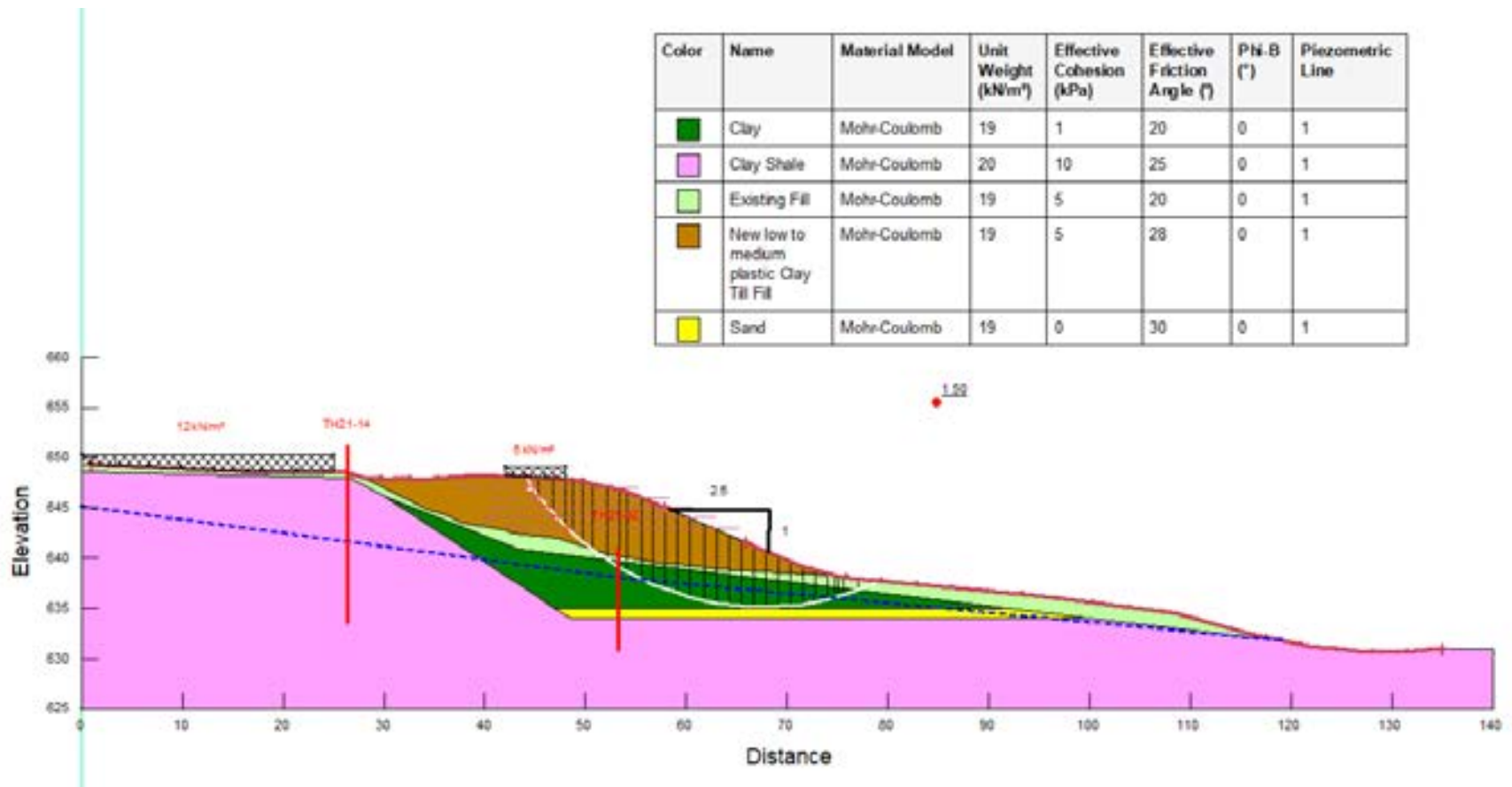

Figure E23: Section W4-W4' – Long Term Conditions



APPENDIX F

Fill Settlement Analysis Results

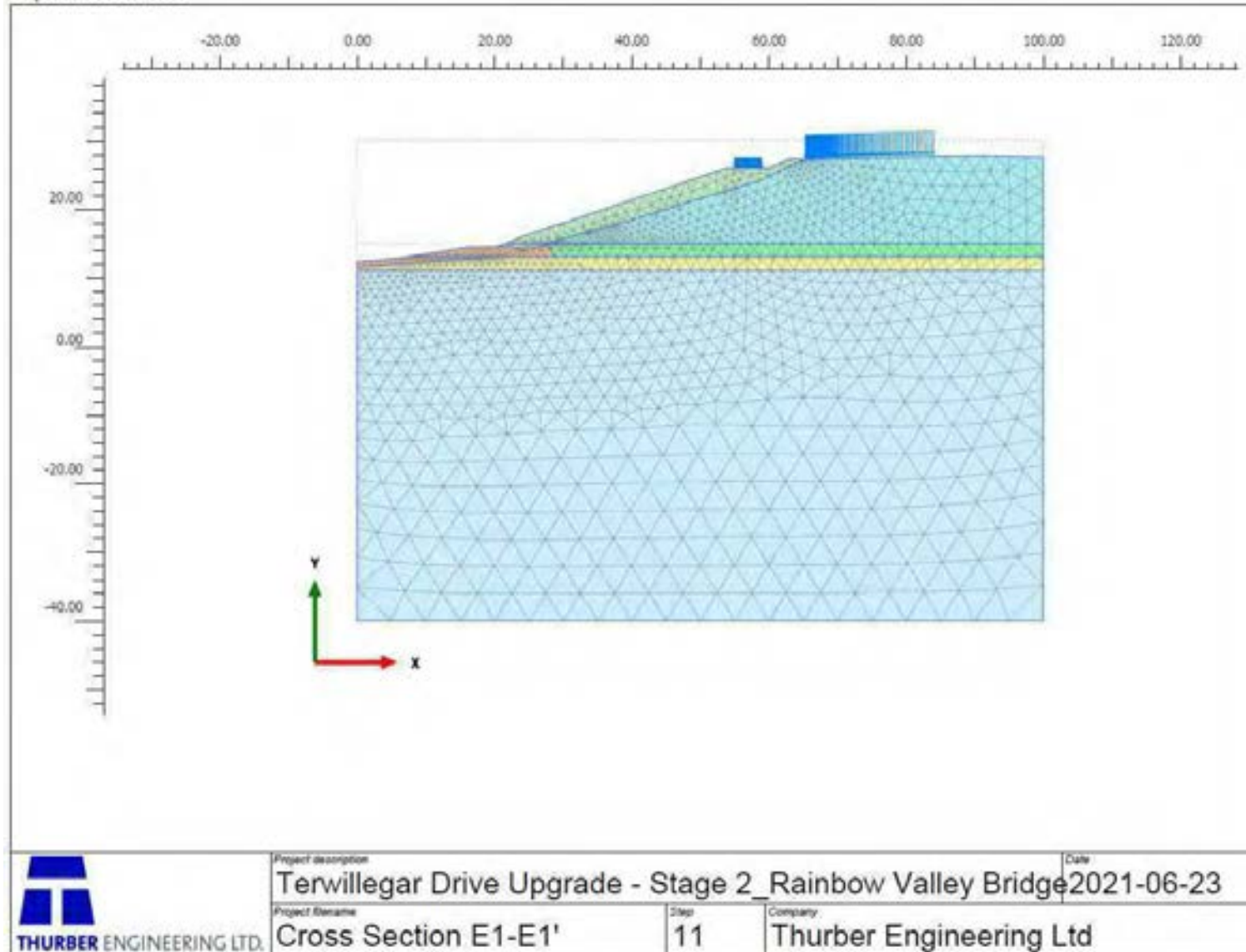

Figure F1: Section E1-E1' – Finite Element Mesh Used in Analysis

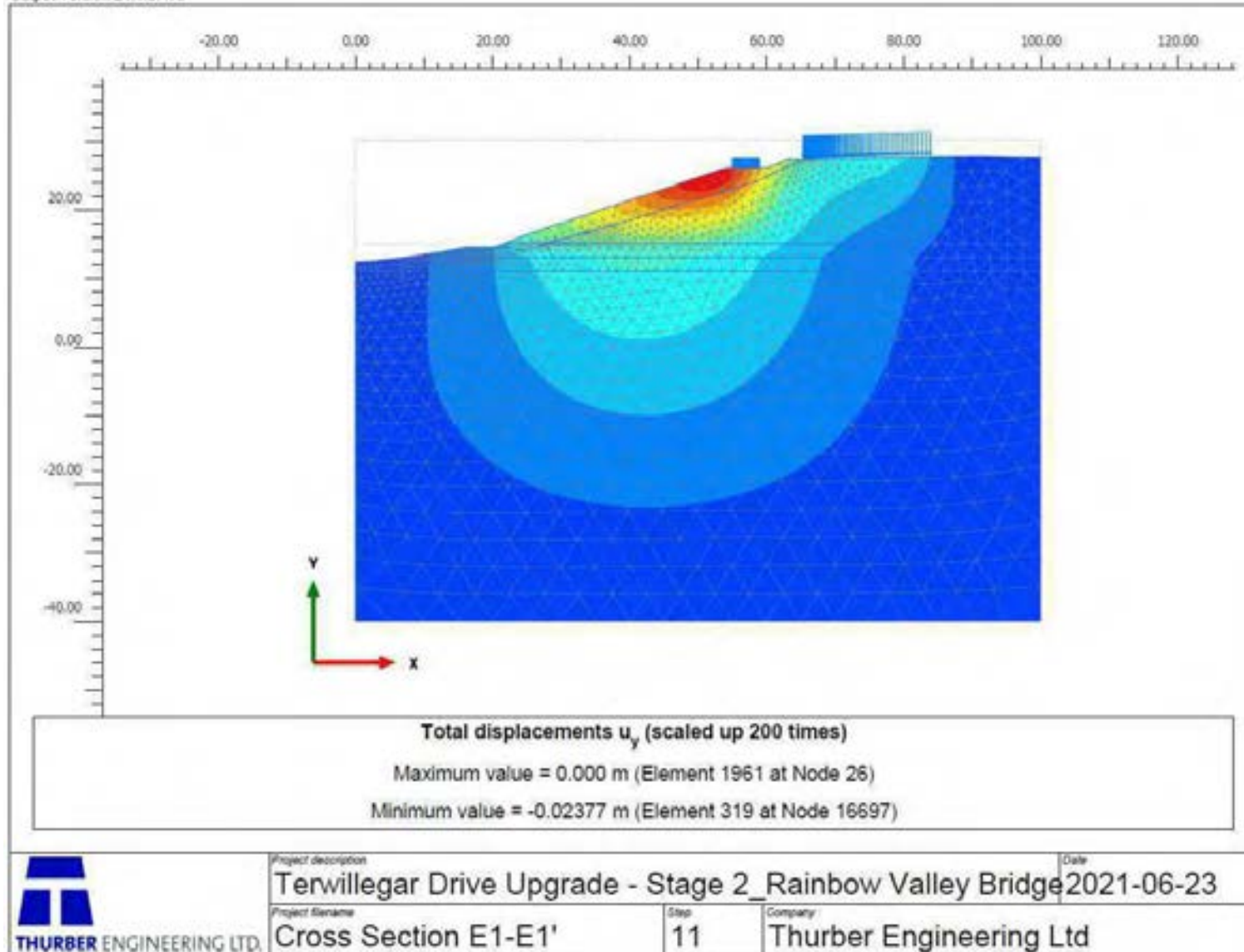

Figure F2: Section E1-E1' – Contours of Long-Term Vertical Settlements

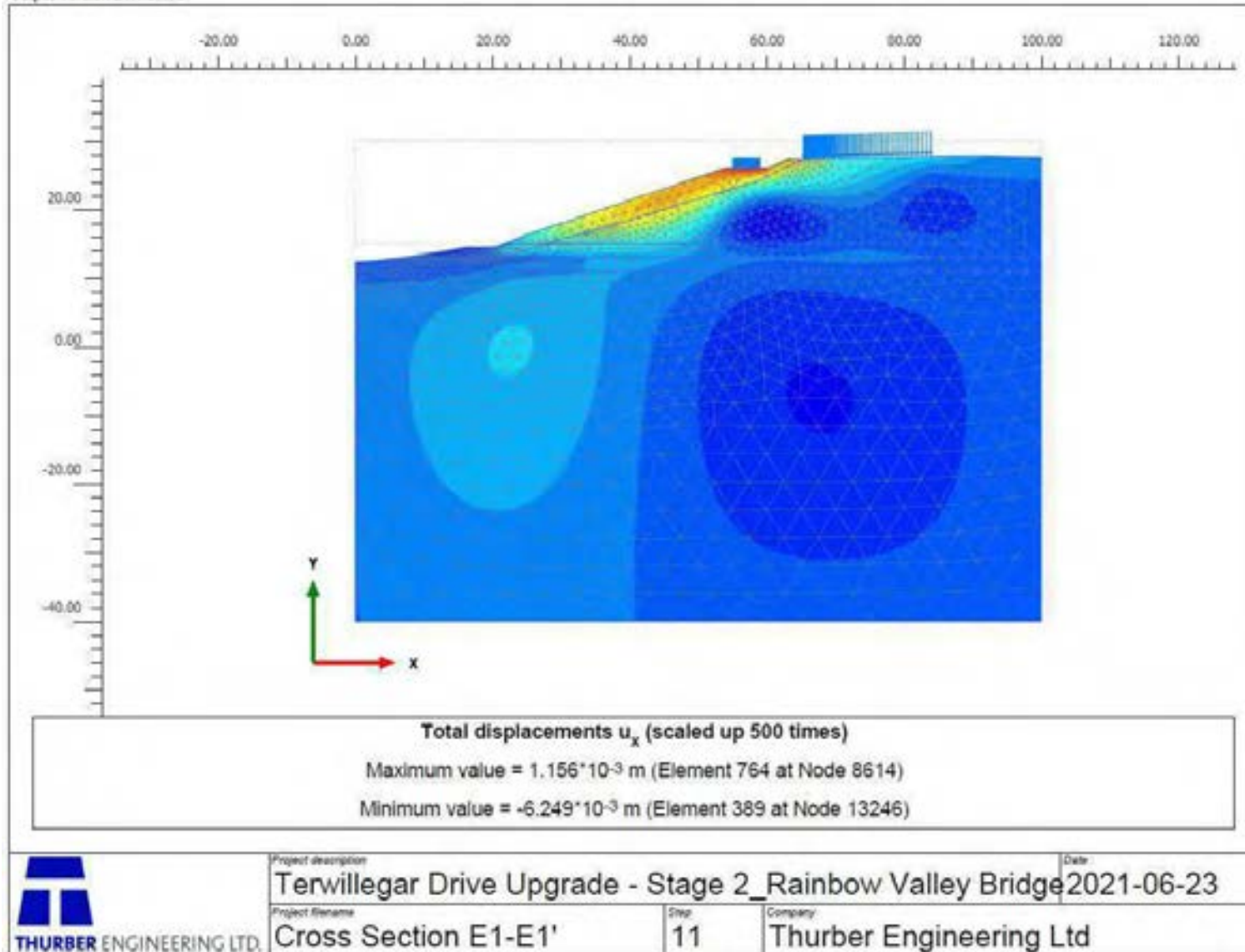

Figure F3: Section E1-E1' – Contours of Long-Term Lateral Deformations

Output Version 21.1 0.479

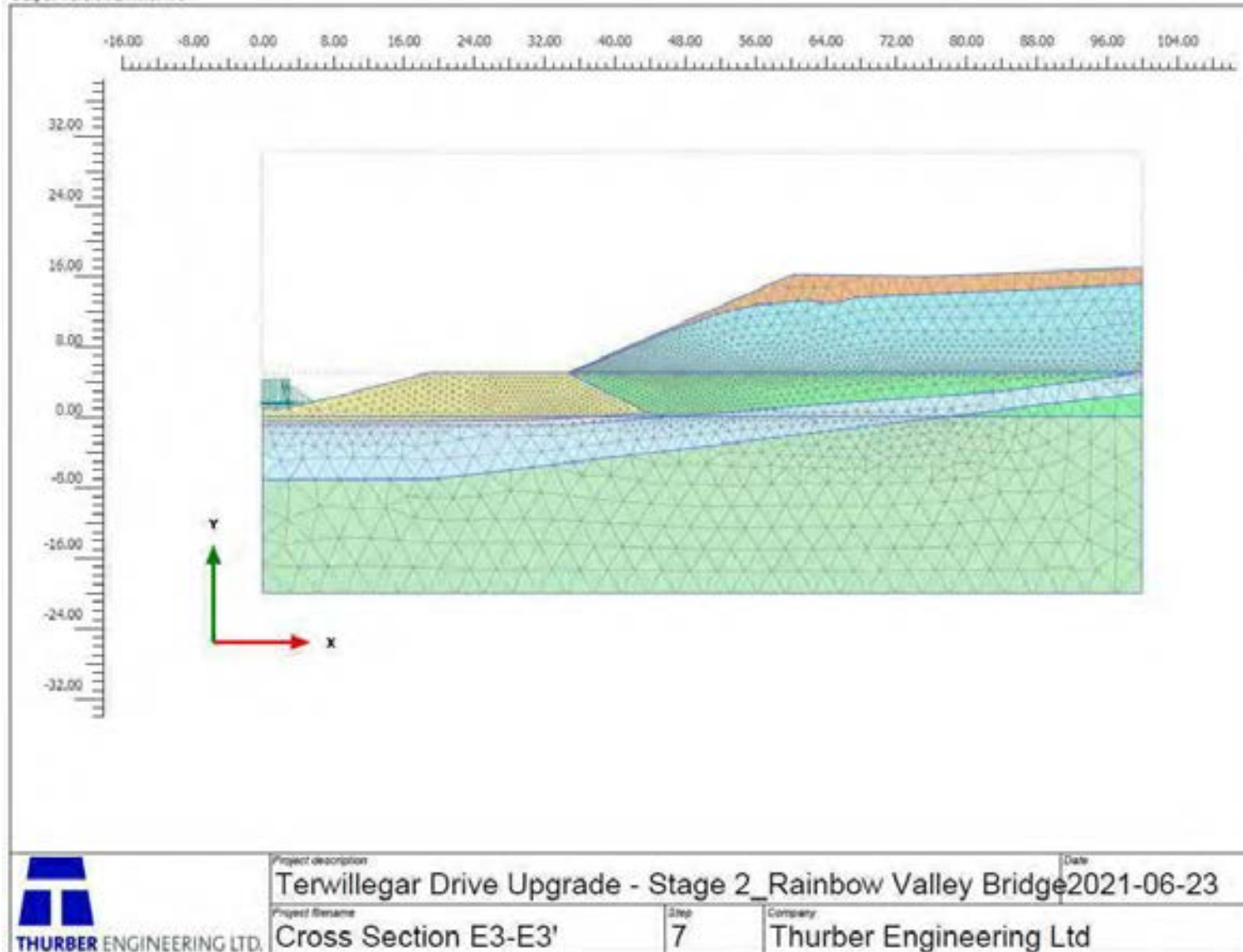

Figure F4: Section E3-E3' – Finite Element Mesh Used in Analysis

Output Version 21.1.0.479

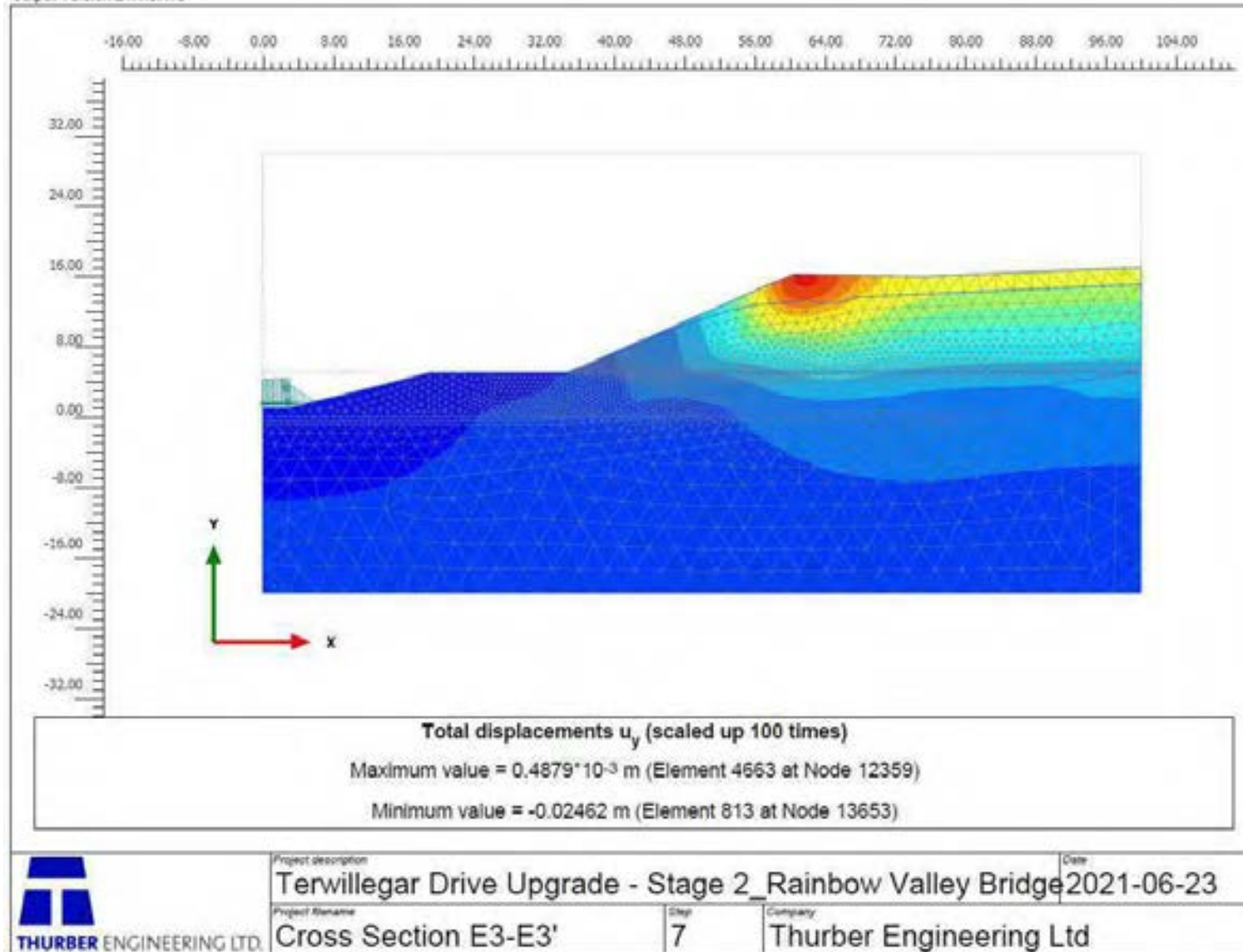

Figure F5: Section E3-E3' – Contours of Long-Term Vertical Settlements

Output Version 21.1.0.479

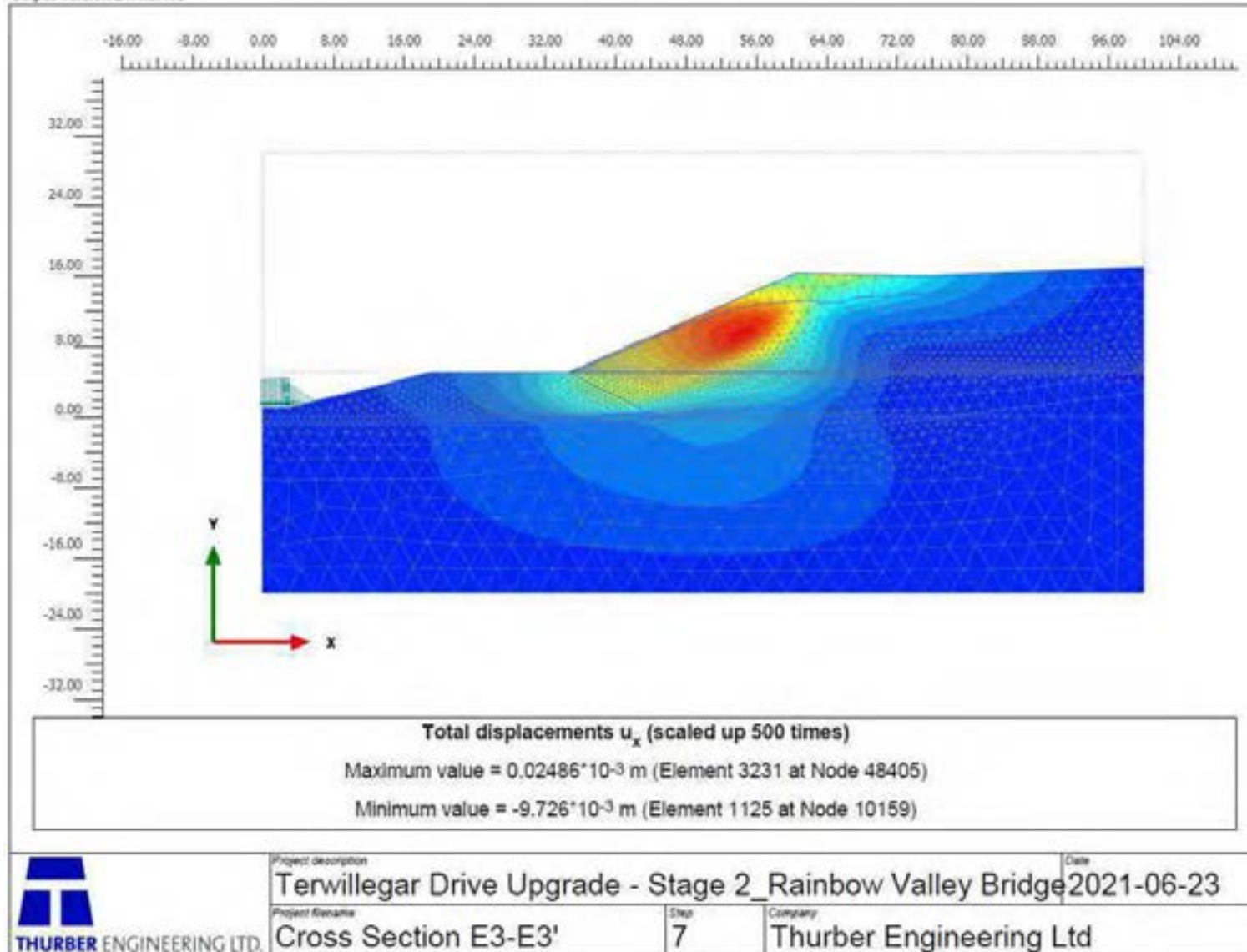

Figure F6: Section E3-E3' – Contours of Long-Term Lateral Deformations

Output Version 21.1.0.479

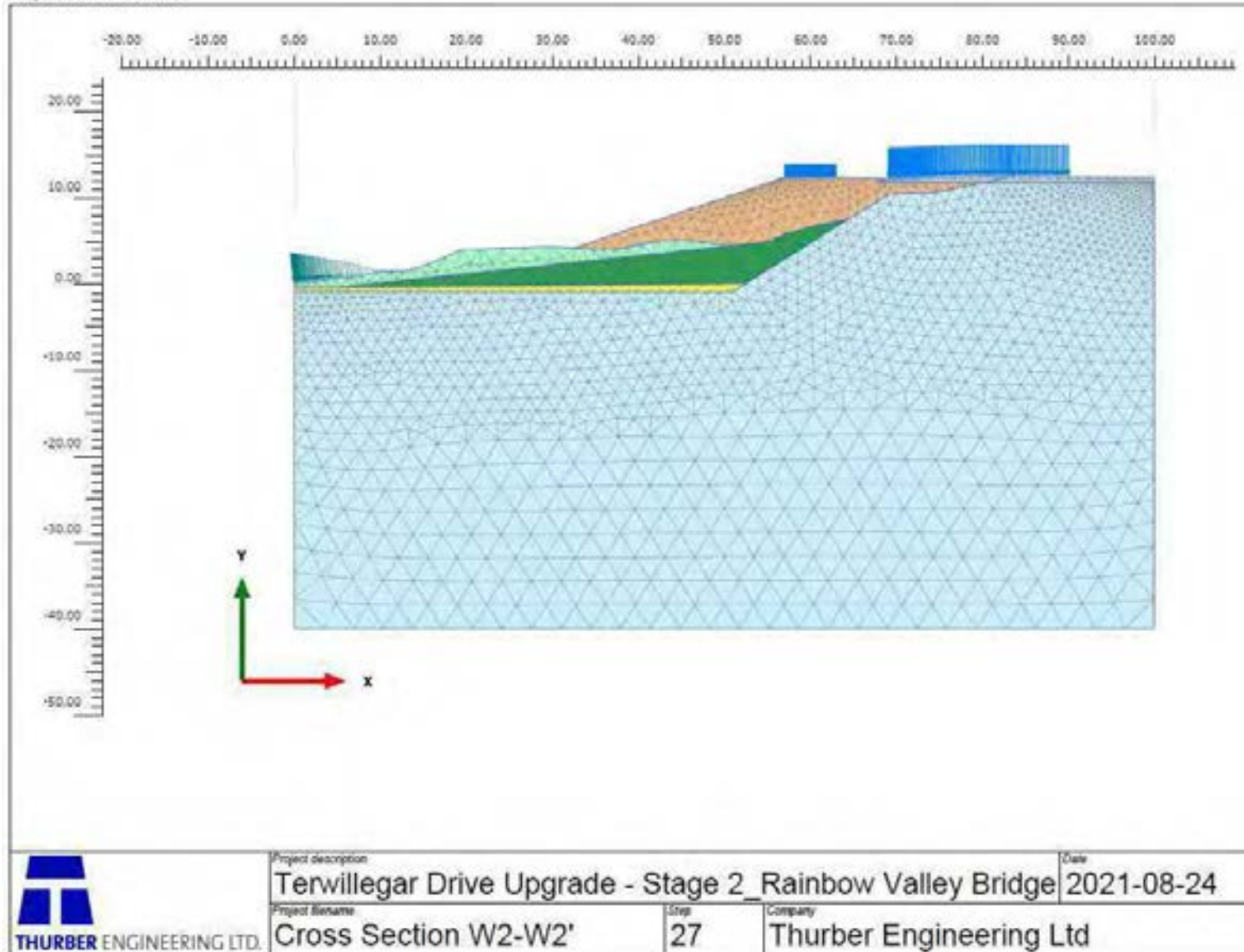

Figure F7: Section W2-W2' – Finite Element Mesh Used in Analysis

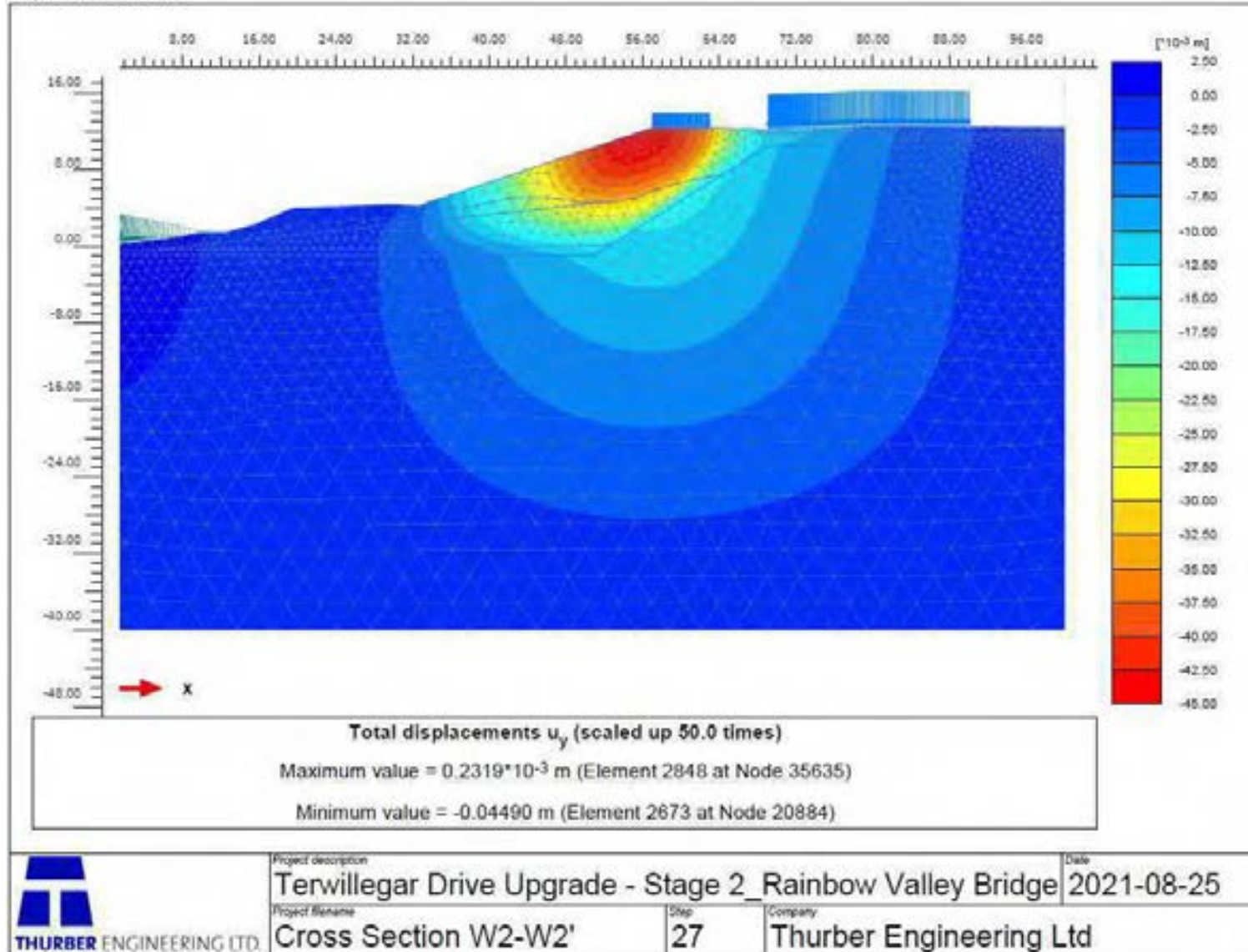

Figure F8: Section W2-W2' – Contours of Long-Term Vertical Settlements

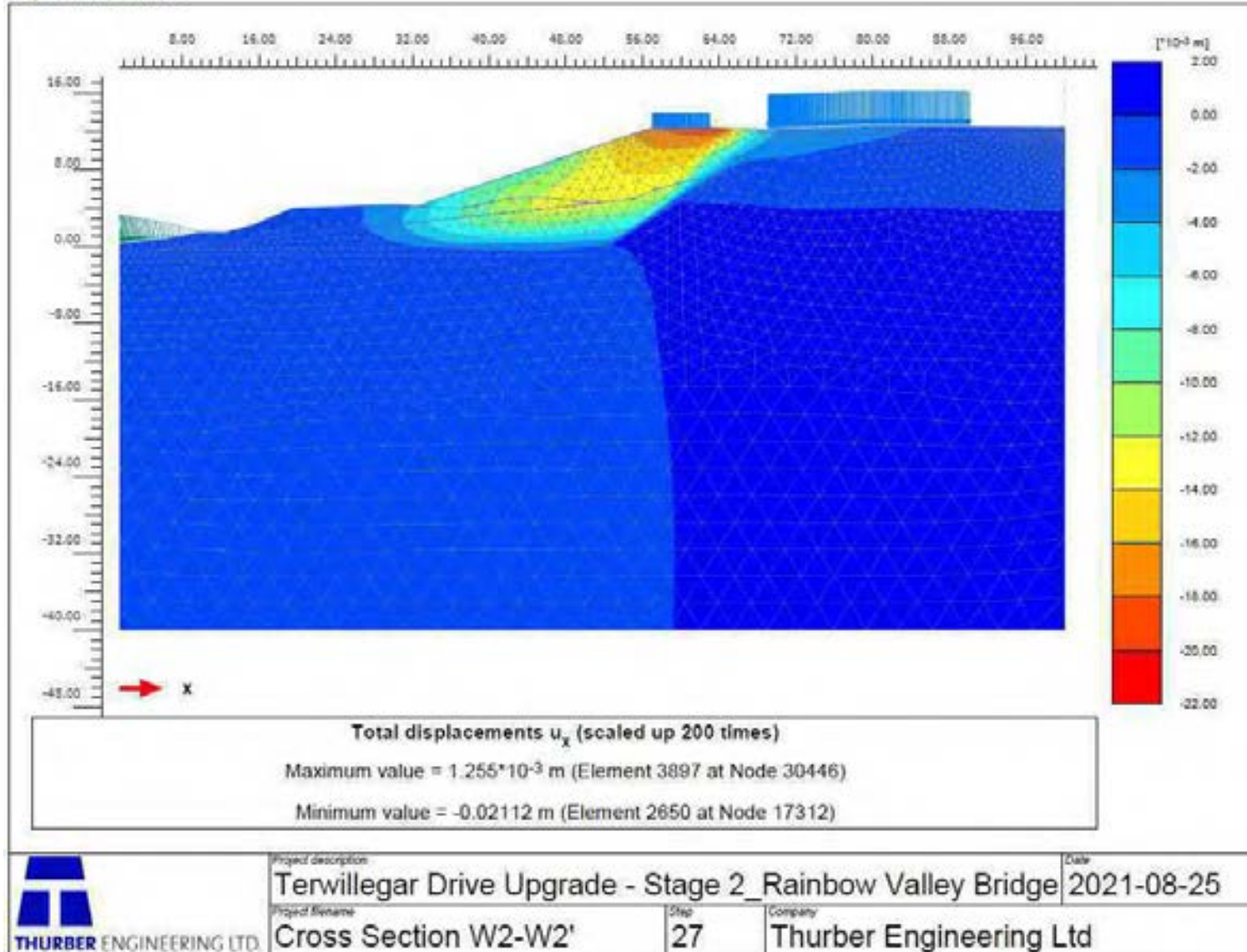

Figure F9: Section W2-W2' – Contours of Long-Term Lateral Deformations

Output Version 21.1.0.479

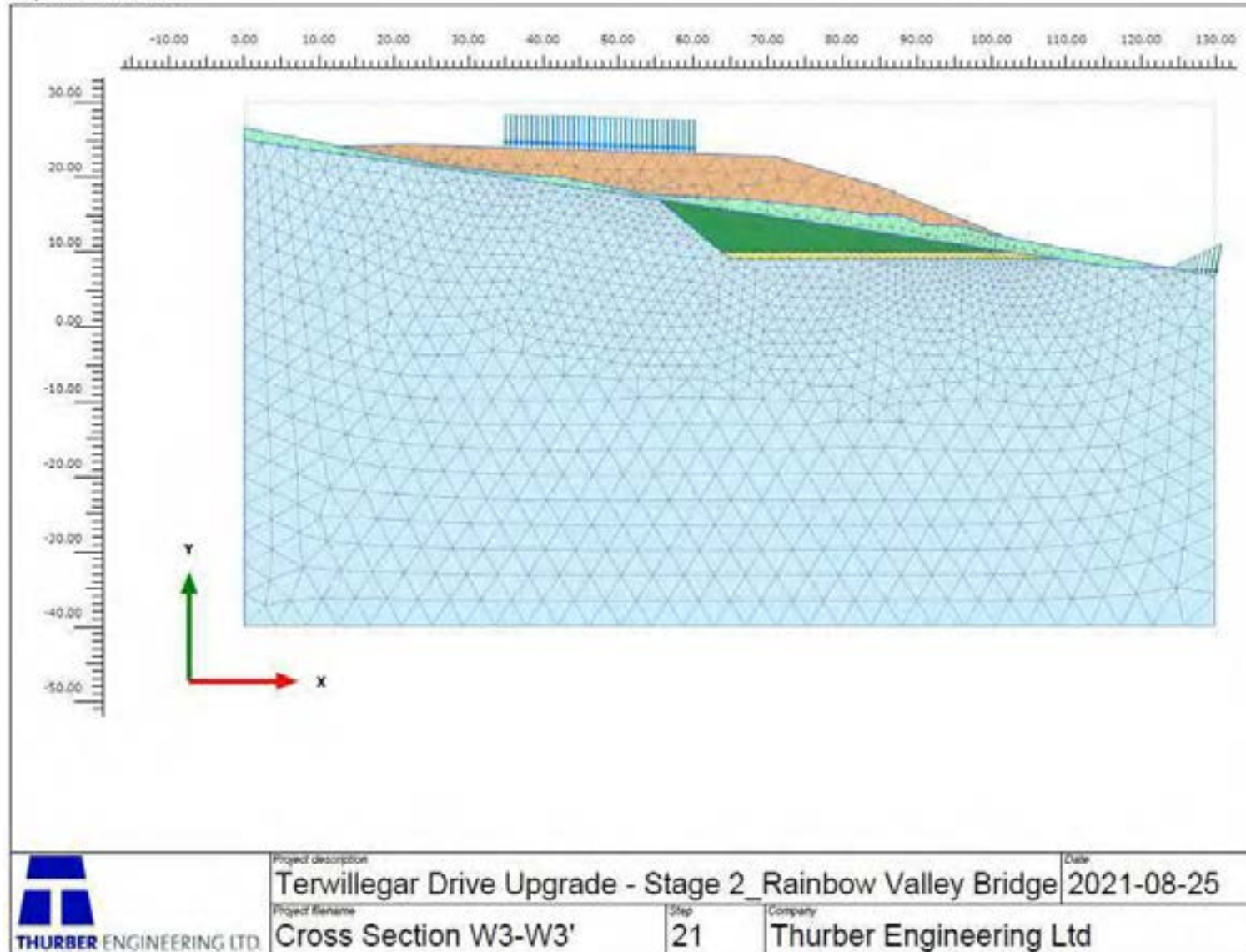

Figure F10: Section W3-W3' – Finite Element Mesh Used in Analysis

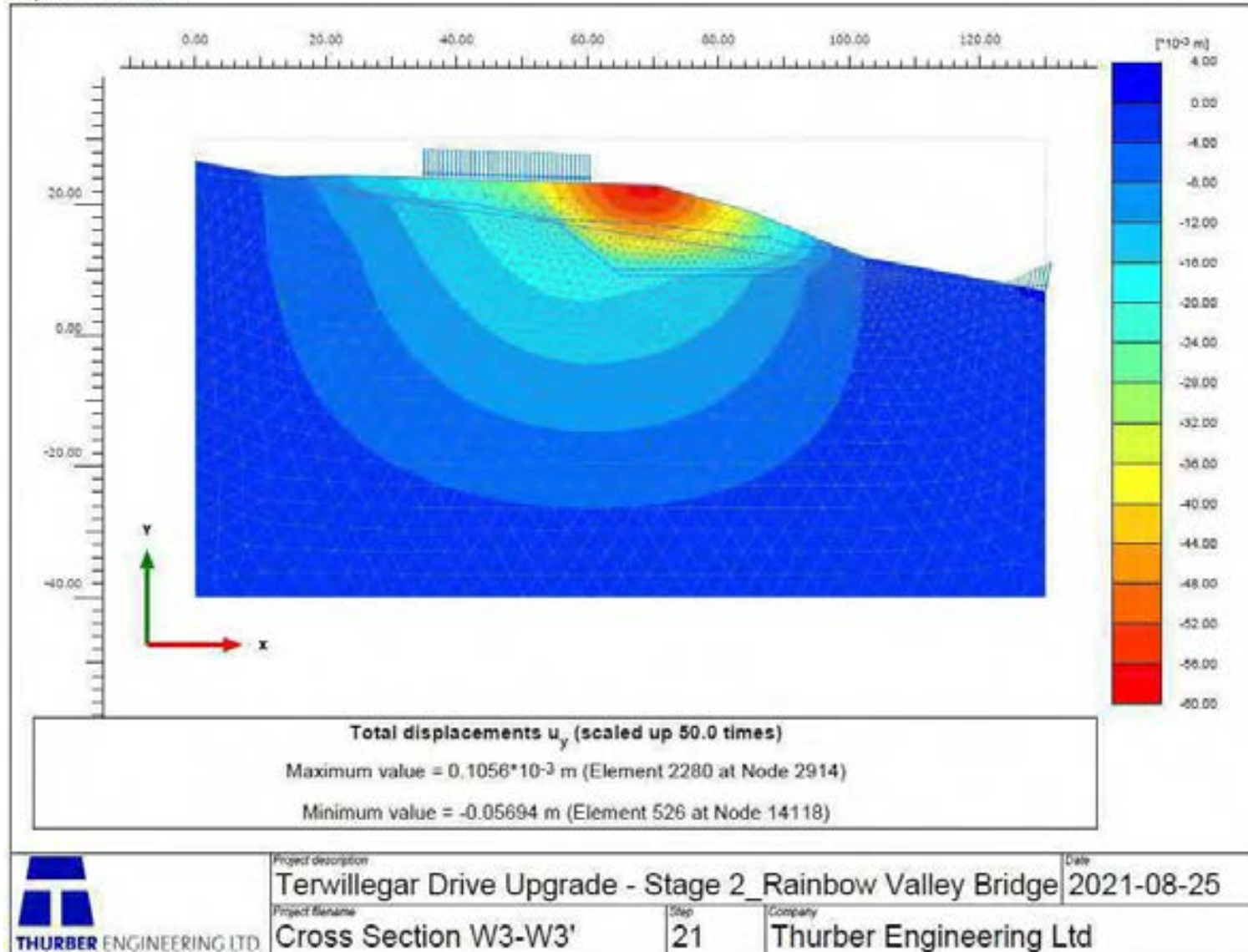

Figure F11: Section W3-W3' – Contours of Long-Term Vertical Settlements

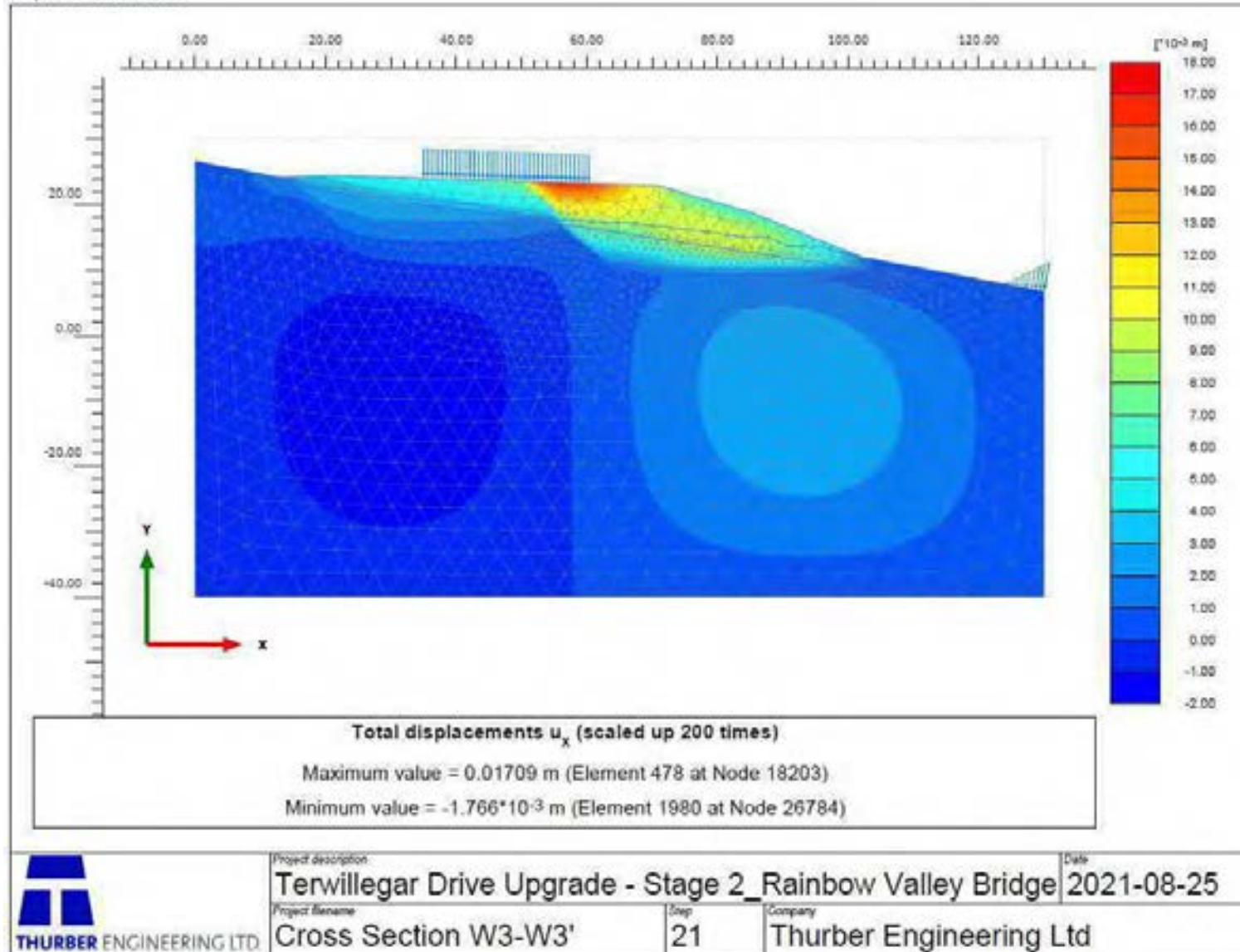

Figure F12: Section W3-W3' – Contours of Long-Term Lateral Deformations

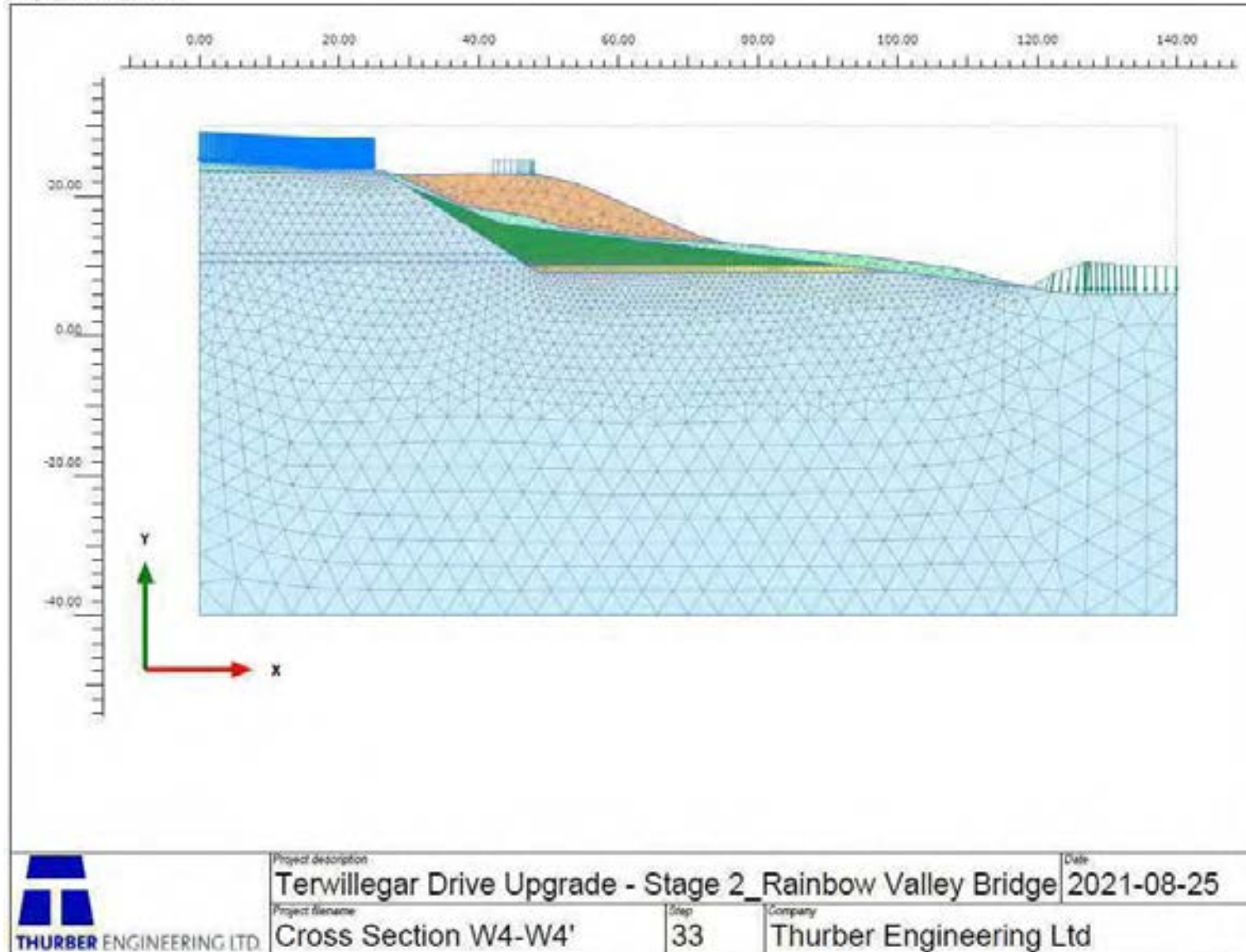

Figure F13: Section W4-W4' – Finite Element Mesh Used in Analysis

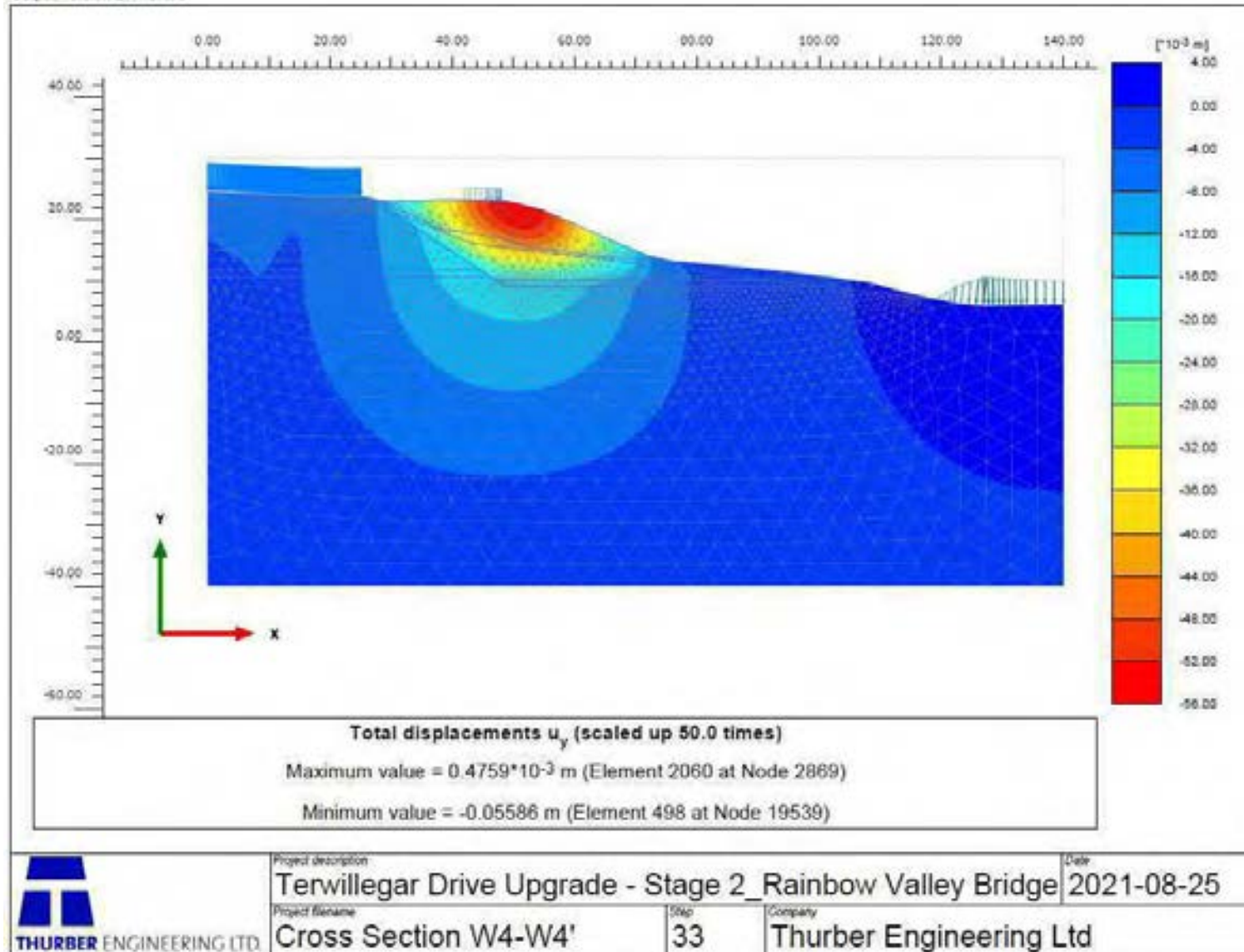

Figure F14: Section W4-W4' – Contours of Long-Term Vertical Settlements

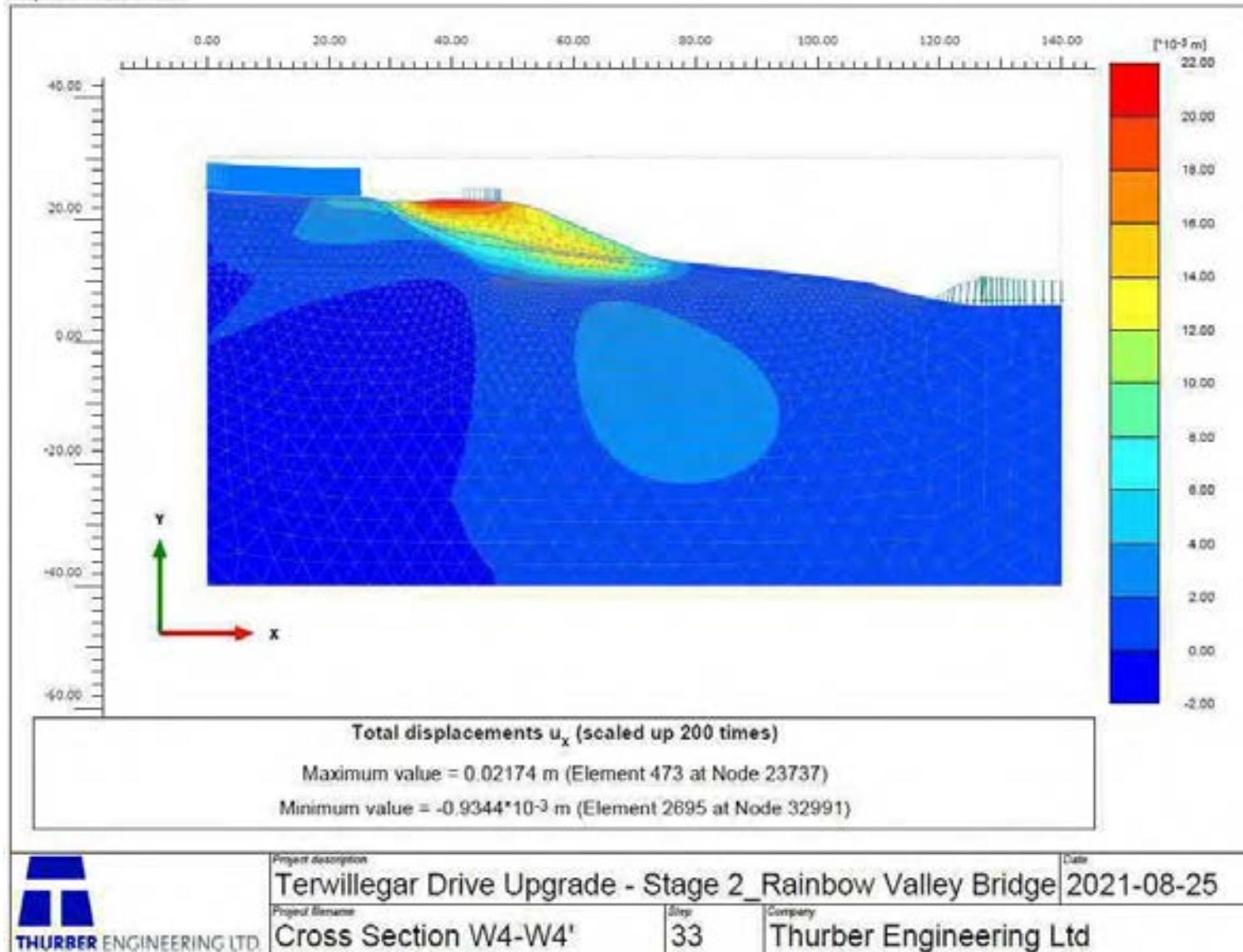

Figure F15: Section W4-W4' – Contours of Long-Term Lateral Deformations

August 9, 2021

File No.: 30442

CIMA+
#100, 14535 118 Avenue
Edmonton, Alberta
T5L 2M7

Attention: Mr. Reg Ball

**GEOTECHNICAL ASSESSMENT AND PRELIMINARY RECOMMENDATIONS
FOR RETAINING WALLS EAST OF TERWILLEGAR DRIVE AND
SOUTH OF WHITEMUD DRIVE
TERWILLEGAR DRIVE UPGRADING – STAGE 2**

Dear Mr. Ball:

As requested, Thurber Engineering Ltd. (Thurber) has conducted a geotechnical assessment for the two newly proposed retaining walls of the above noted project. The walls will be located to the south and east of the Terwillegar Drive / Whitemud Drive Interchange. This letter summarizes the findings of the geotechnical assessment and provides preliminary recommendations for wall design.

It is a condition of this letter that Thurber's performance of its professional services is subject to the attached Statement of Limitations and Conditions.

1. INTRODUCTION

Thurber was retained by CIMA+ to carry out the geotechnical investigations and assessments for the Terwillegar Drive Upgrading Stage 2 project. The site investigations, laboratory testing, and geotechnical evaluations for various components of the project were completed and the findings were presented to CIMA+ in a series of reports.

Recently, the City requested CIMA+ to consider the use of retaining walls at three locations along the project corridor to limit the extent of grading works and reduce the footprints of backslope excavations. We understand that the followings retaining walls are being evaluated by CIMA+:

- Retaining Wall 1 – located along the east side of the northbound Terwillegar Drive, approximately 200 m south of the Whitemud Drive. The wall is approximately 95 m in length and 1.2 m in height (excluding wall embedment below finished grade). The inclination of the backslope above the top of wall is approximately 3H:1V.
- Retaining Wall 2 – located along the south side of the eastbound Whitemud Drive, approximately 200 m east of Terwillegar Drive. The wall is approximately 310 m in length and 1.4 m in height (excluding wall embedment). The inclination of the cut slope above the top of wall is approximately 3H:1V.
- Retaining Wall 3 – located along the north side of the westbound Whitemud Drive west of the Whitemud Creek. The wall is approximately 100 m in length and 2.0 m in height

(excluding wall embedment). The inclination of the cut slope above the wall is approximately 3H:1V.

The above retaining walls were not part of the original project scope and, hence, the completed geotechnical investigation did not specifically target the wall sites. Limited geotechnical information is, however, available in the general vicinities of Retaining Walls 1 and 2. No geotechnical information is available at/near Retaining wall 3, and a site investigation program is currently underway to drill two test holes at the wall location.

This report addresses Retaining Walls 1 and 2 based on existing geotechnical information. Drawing 30442.TDS2-1 in Appendix A shows the proposed locations and alignments of the two walls. The following sections discuss the anticipated subsurface conditions at each wall site and provide recommendations pertaining to the design of different wall systems.

Retaining Wall 3 will be addressed under a separate cover once the geotechnical investigation is completed.

2. GEOTECHNICAL INVESTIGATIONS

2.1 Current Investigation

Two test holes from the current drilling program, TH21-21, and TH21-15, were advanced in the vicinity of Retaining Walls 1 and 2, respectively. Test hole TH21-15 was drilled to a depth of 19.5 m below ground surface while TH21-21 was advanced to a depth of 30.2 m. The locations of the two test holes are shown on Drawing 30442.TDS2-1 in Appendix A.

Prior to drilling, test hole locations were cleared of underground utilities through Alberta One-Call and a private locator. Test hole drilling was completed using a track-mounted drill rig equipped with both solid and hollow stem augers. The drill rig was provided by All Service Drilling Inc. of Nisku, Alberta. Thurber's field drilling inspectors supervised the drilling program, logged the subsoil conditions, and collected disturbed and relatively undisturbed (Shelby Tube) soil samples at regular intervals for laboratory testing and characterization. Standard Penetration Tests (SPTs) were conducted at selected depths in both test holes. Observations of groundwater seepage and sloughing of the test hole walls were noted during and upon completion of drilling.

Slotted 25 mm diameter polyvinyl chloride (PVC) standpipe piezometers were installed in both test holes to allow for monitoring of groundwater levels. The standpipe installation details are shown on the test hole logs in Appendix B.

Upon completion of drilling, excess drill cuttings were removed from site and disposed of appropriately.

Laboratory testing included visual classification and the determination of natural moisture content for all disturbed soil samples. In addition, the following laboratory tests were carried out on selected soil samples:

- Atterberg Limits

- Grain size analysis
- Unconfined compressive strength testing
- Direct Shear strength testing
- Cyclic confined compression triaxial testing
- Water-soluble sulphate content testing.

The results of laboratory tests are noted on the test hole logs in Appendix B, and the detailed laboratory data sheets are included in Appendix C.

2.2 Previous Geotechnical Investigations

The results of test holes TH21-15 and TH21-21 were supplemented with existing information from previous geotechnical investigations conducted in the vicinity of the proposed retaining walls. Information from the following references was used in this study:

- EBA Engineering Consultants Ltd., 1975. "Geotechnical Evaluation – Whitemud Drive: Report No. 4, Centreline Along 45 Ave", August 1975. File: E-1060.
- Thurber Engineering Ltd., 2019. "Terwillegar Drive Expressway: Anthony Henday Drive to Terwillegar Drive, Edmonton, Alberta Geotechnical Investigation", December 2019. File: 19715.
- Thurber Engineering Ltd., 2021. Investigation for 142 Street Pedestrian Bridge, Edmonton, Alberta (currently in process).

Drawing 30442.TDS2-1 in Appendix A shows the locations of previous test holes used in the evaluation of the subsurface conditions at the wall locations.

3. SUBSURFACE SOIL AND GROUNDWATER CONDITIONS

3.1 Retaining Wall 1 (East of Northbound Terwillegar Drive)

A list of test holes used in assessing the soil and groundwater conditions at the site of Retaining Wall 1 is provided in Table 3.1.

TABLE Error! No text of specified style in document..1
RETAINING WALL 1 - SUMMARY OF TEST HOLE DETAILS

TEST HOLE NO.	DRILL DATE	DEPTH (m)	STANDPIPE PIEZOMETER
TH19-01	March 14, 2019	7.3	Yes
TH19-41	July 22, 2019	10.4	Yes
TH19-42	July 22, 2019	10.4	No
TH21-21	April 10, 2021	30.2	Yes

Available test hole information suggests that soils at the location of Retaining Wall 1 are expected to consist of topsoil followed by glaciolacustrine clay, clay till with interbedded layers of silt and sand, over bedrock. Generalized descriptions of the encountered soil units are provided in the following paragraphs. Detailed descriptions of the encountered soils are provided on the individual test hole logs in Appendix B.

Topsoil was encountered at the ground surface in all test holes and varied in thickness between 0.1 and 0.2 m. The topsoil consisted of organic material containing rootlets and varying amounts of sand and gravel.

Glaciolacustrine clay was encountered immediately beneath the topsoil in test holes TH19-42 and TH21-21 and beneath a layer of clay fill in TH19-01. The clay extended to depths ranging between 2.7 and 10.4 m below ground surface (elevations 663.9 to 669.9 m). No glaciolacustrine clay was encountered in TH19-41. It is likely that the clay was removed during construction of the Terwillegar Drive northbound to Whitemud Drive eastbound off ramp. The clay was light brown to dark grey, silty, contained varying amounts of sand, and occasionally contained silt lenses, trace oxides, trace coal, trace gravel, and sand inclusions. The natural moisture content of the clay varied from 25 to 38 percent. One Atterberg Limits test completed on a clay sample from TH21-21 yielded liquid and plastic limits of 53 and 23 percent, respectively, indicating that the clay is high plastic. Standard Penetration Test (SPT) 'N' values measured in the clay typically ranged from 5 to 17 blows per 300 mm of sampler penetration, indicating firm to very stiff consistency.

Clay till was encountered in every test hole except TH19-01, which was only 7.3 m deep. The top of the clay till was encountered at depths ranging between 2.7 and 14.2 m (corresponding to elevations between 660.1 and 669.9 m) and extended to 26.2 m depth (elevation 648 m) in TH21-21. In the remainder test holes, the clay till extended to the termination depths of the holes. The clay till was brown to dark grey, silty, and contained varying amounts of sand, trace to some gravel, trace oxides, and trace to some coal. The natural moisture content of the clay till varied from 13 to 37 percent. Two Atterberg Limits tests completed on samples of the clay till resulted in plastic limits of 15 and 24 percent and liquid limits of 32 and 42 percent, indicating that the clay till is medium plastic. SPT 'N' values measured in the clay till ranged generally from 9 to greater than 50 blows per 300 mm of sampler penetration, indicating stiff to hard consistency. One lower 'N' value of 5 blows was recorded in TH19-41 at the clay fill/clay till interface. In TH19-41, a layer of hard silty clay was encountered within the clay till at 8.4 m depth and extended to the termination depth of the test hole at 10.4 m below ground. A horizon of rafted sandstone, 0.6 m thick, was also encountered within the clay till in TH21-21 at 23.6 m depth.

Interbedded silt and sand layers were encountered within or above the clay till in all test holes starting at depths between 4.6 and 10.4 m. The thickness of silt/sand layers ranged between 1.0 to greater than 4.8 m. The sand was light brown to grey, fine to medium grained, and contained varying amounts of silt and clay, and occasionally trace oxides. The natural moisture content of the sand varied from 4 to 17 percent. One grain size analysis of a sand sample from TH19-42 indicated that the sample consists of 90 percent sand and 10 percent fines (silt and clay), by weight. One SPT 'N' value measured in the sand was 23 blows per 300 mm of sampler penetration, indicating a compact relative density.

The silt was light brown to dark grey and contained varying amounts of clay, trace to some fine sand, trace to some oxides, and occasionally trace gravel. The natural moisture content of the silt varied from 8 to 31 percent. One grain size analysis on a silt sample from TH21-21 indicated that the sample consists of 9 percent sand, 84 percent silt, and 7 percent clay, by weight. SPT 'N' values measured in the silt ranged from 13 to 41 blows per 300 mm of sampler penetration, indicating a compact to dense state.

Bedrock, composed of sandstone and clay shale, was encountered in TH21-21 at a depth of 26.2 m (corresponding to elevation 648.0 m) and extended to the termination depth of the test hole at 30.2 m below ground surface. The bedrock was grey to black, contained varying amounts of clay, sand, and silt, and contained trace to some coal inclusions. The natural moisture content of the bedrock varied between 19 and 23 percent. SPT 'N' values measured in the bedrock were greater than 50 blows per 300 mm of sampler penetration, indicating hard consistency, in soil mechanics terminology.

Groundwater was measured in standpipes installed in TH19-01, TH19-41, and TH21-21 at varying periods after drilling completion. The depth to water varied from 6.6 to 14.8 m (approximate elevations 659.5 to 663.2 m). It should also be noted that seepage was encountered at depths as shallow as 8.4 m below ground surface in TH21-21, which corresponded to elevation 665.9 m.

3.2 Retaining Wall 2 (South of Eastbound Whitemud Drive)

Table 3.2 presents a list of the test holes used to characterize the soil and groundwater conditions at the site of Retaining Wall 2. The location of these test holes are presented on Drawing 30442.TDS2-1 in Appendix A.

**TABLE Error! No text of specified style in document..2
RETAINING WAL 2 – SUMMARY OF TEST HOLE DETAILS**

TEST HOLE NO.	DRILL DATE	DEPTH (m)	STANDPIPE PIEZOMETER
75-TH22	May 5, 1975	9.0	No
75-TH23	May 5, 1975	9.0	No
TH21-15	March 30, 2021	19.5	Yes (2 SPs)
TH21-2	July 17, 2021	24.1	No
TH21-3	July 10, 2021	30.2	Yes

Note: SP = standpipe piezometer

Available test hole information indicates that soil conditions at the site of Retaining Wall 2 are expected to generally consist of topsoil or organic material followed by glaciolacustrine clay, clay till with interbedded layers of sand, over bedrock.

Generalized descriptions of the anticipated soil units are provided in the following paragraphs. A simplified stratigraphic profile along the retaining wall alignment is presented on

Drawing 30442.TDS2-3 in Appendix A. Detailed descriptions of the encountered soils are provided on the individual test hole logs in Appendix B.

Topsoil or organic material was encountered at the surface of every test hole except TH21-2. The thickness of topsoil/organic material ranged between 0.2 and 0.3 m. The topsoil/organic material was black and contained trace rootlets.

Glaciolacustrine clay was encountered beneath the topsoil/organics in every test hole, except TH21-2 which was drilled on the Whitemud Drive for the planned 142 Street pedestrian bridge. The clay extended to depths ranging between 5.3 and 8.0 m below ground surface (elevations 663.1 to 665.7 m). The clay was brown to dark brown, silty, and occasionally fissured, calcareous, and mottled grey-brown. The clay also occasionally contained layers or inclusions of silt, trace oxides, and trace coal. The natural moisture content of the clay varied from 17 to 39 percent. One Atterberg Limits test completed on a sample of the clay from the base of the strata in TH21-15 resulted in a plastic limit of 28 percent and a liquid limit of 45 percent, indicative of medium plasticity. Visual descriptions of clay samples at higher elevations suggest, however, that the lacustrine clay is predominantly high plastic. SPT 'N' values measured in the clay ranged from 7 to 14 blows per 300 mm of sampler penetration, indicating firm to stiff consistency.

Clay till was encountered in all test holes at depths ranging between 5.3 and 8.0 m (elevations 657.1 to 665.7 m). Only test holes TH21-02 and TH21-03 fully penetrated the clay till deposit into the underlying bedrock. The clay till/bedrock interface was encountered at elevations ranging between 646.9 and 649.4 m. The till consisted of a mixture of clay, silt, and sand in varying proportions. It was dark brown to dark grey, contained trace gravel, trace coal, and trace oxides. The natural moisture content of the till varied from 11 to 28 percent. One Atterberg Limits test completed on a sample of the clay till resulted in a plastic limit of 17 percent and a liquid limit of 34 percent, indicating that the clay till is medium plastic. SPT 'N' values measured in the till ranged from 21 to 52 blows per 300 mm of sampler penetration, indicating very stiff to hard consistency.

Sand layers, 0.2 m up to 7.9 m thick, were encountered within or above the clay till in every test hole. The sand was light brown to grey, fine to medium grained, silty, contained trace gravel, trace coal, and trace oxides, and occasionally contained trace clay. The natural moisture content of the sand ranged from 4 to 24 percent. SPT 'N' values measured in the sand ranged from 28 to greater than 50 blows per 300 mm of sampler penetration, indicating compact to very dense state.

Bedrock, composed of sandstone and clay shale, was encountered below the till in the deeper test holes, TH21-2 and TH21-3, at depths of 13.6 and 25.6 m, respectively (elevations 649.4 and 646.9 m, respectively). The bedrock was predominantly weathered grey clay shale with varying amounts of sand and silt, occasionally contained sand inclusions, trace coal, and trace gravel, and was occasionally bentonitic. The natural moisture content of the bedrock varied between 15 and 24 percent. SPT 'N' values measured in the bedrock were 50 blows, or greater, per 300 mm of sampler penetration, indicating a hard consistency.

The groundwater level was measured in TH21-15 on July 2, 2021. It was observed at 9.2 m below ground surface, which corresponds to elevation 660.3 m. The groundwater level was also measured in TH21-3 at the end of drilling. It was observed at 24.8 m depth below the ground

surface which corresponds to elevation 647.7 m. Based on the moisture content profile and seepage zones observed during drilling, it appears, however, that the groundwater table in TH21-03 could be at approximate elevation 658 m.

4. RETAINING WALL GEOMETRY

The geometry of the proposed Retaining Walls 1 and 2 was provided by CIMA+ on July 20, 2021, and July 22, 2021. The following subsections present brief descriptions of the wall and backslope geometries.

4.1 Retaining Wall 1

Retaining Wall 1 located along the east side of Terwillegar Drive varies between approximately 0.9 and 1.2 m in design height (i.e., height above finished grade) and retains a cut slope with a grade of approximately 3H:1V. The maximum height of the cut slope is approximately 5.3 m, with residential properties located behind the crest of the slope. The length of the retaining wall is approximately 95 m. A profile and a cross-section of the retaining wall are presented on Drawing 30442.TDS2-2 in Appendix A.

4.2 Retaining Wall 2

Retaining Wall 2 along the south side of the eastbound Whitemud Drive has a design height of approximately 1.4 m and retains a cut slope with a grade of approximately 3H:1V. The maximum height of the cut slope is approximately 10.5 m, with residential properties located at the crest of the slope. The length of the retaining wall is approximately 310 m. A profile and a cross-section of the retaining wall are presented on Drawings 30442.TDS2-3 and 30442.TDS2-4, respectively, in Appendix A.

5. GEOTECHNICAL ASSESSMENT AND RECOMMENDATIONS

5.1 Retaining Wall Options

The advantages, limitations, and constructability considerations of various wall options were discussed with Associated Engineering (the structural consultant for the project) at a concept level. Among the options considered were concrete cantilever walls and shotcrete with ground anchors.

Concrete cantilever walls involve bottom-up construction and will require a temporary excavation equivalent to the wall footprint. This type of wall is considered feasible when the retained height of soil is relatively short. The inclination of the backslope of the retained soil increases the earth pressure and can also influence the feasibility of cantilever walls.

Shotcrete with ground anchors is a top-down construction system and is considered feasible for the two proposed retaining walls.

The following sections present the results of the preliminary analyses completed for each wall option and provide geotechnical recommendations for wall design.

5.2 Geotechnical Parameters

The stability and performance of retaining walls are governed by the mechanical properties of the foundation soils below the base of the wall and soils retained behind the wall. The soils retained behind the proposed walls are expected to comprise mostly native glaciolacustrine clay. Below the base of the retaining walls, clay is expected at Retaining Wall 1, and clay till with interbedded sand/silt layers is expected at Retaining Wall 2. Table 5.1 presents a summary of the geotechnical parameters used in analyzing the two types of retaining walls discussed in this report. These parameters were estimated from the results of the completed geotechnical investigation and our local experience in the Edmonton area.

**TABLE ERROR! NO TEXT OF SPECIFIED STYLE IN DOCUMENT..3
SUMMARY OF GEOTECHNICAL PARAMETERS USED IN RETAINING WALL ANALYSES**

SOIL LAYER	BULK UNIT WEIGHT, γ (kN/m ³)	COHESION, c' (kPa)	INTERNAL ANGLE OF FRICTION, ϕ' (degrees)	UNDRAINED SHEAR STRENGTH (kPa)
Clay	19	10	22	60
Clay Till (with interbedded Sand/Silt)	19	5	28	150
Bedrock	20	20	20	200

Based on available measurements of groundwater levels, it is expected that the groundwater table will vary between the two walls and may even vary along the alignment of a given wall. For design, it was assumed that the groundwater level is at elevation 667 m for Retaining Wall 1 and 661 m for Retaining Wall 2.

In the global stability analyses of the walls, a pore pressure ratio R_u (defined as the ratio of pore water pressure to overburden stress) of 0.2 was adopted for the glaciolacustrine clay and the clay till to account for the possibility of shallow perched water in these units

5.3 Concrete Cantilever Wall

5.3.1 General

Concrete cantilever retaining walls have previously been used to support short vertical cuts in Edmonton (e.g., the retaining wall on the south side of Fox Drive beneath the Whitemud Drive bridge). The advantage of this system is that it does not require any reinforcing elements (e.g., ground anchors or soil nails) that could extend well behind the wall face and come into conflict with existing infrastructure or require underground easements. Cast-in-place concrete walls also tend to be cost effective, especially for small wall heights. In cut situations, construction of this type of wall, however, requires a wide temporary excavation to accommodate the wall footing and any unsupported excavation slopes.

Geotechnical recommendations for the design of concrete cantilever walls are provided in the following subsections, including assessments of the walls' global stability.

5.3.2 Lateral Earth Pressure – Concrete Cantilever Walls

The lateral pressures, p_h , used in the design of concrete cantilever walls may be estimated using the expression provided below. Table 5.2 provides the recommended values of the coefficients of lateral earth pressure and the bulk unit weights for the anticipated soil types. The submerged unit weight of the soil (bulk unit weight minus unit weight of water) should be used below the groundwater level and the hydrostatic water pressure should be taken into consideration in the design. The design groundwater levels were discussed in Section 5.2.

$$p_h = K [(\gamma \times h) + q] \quad (\text{kPa})$$

Where:

K = coefficient of earth pressure (Table 5.2)

γ = soil unit weight, kN/m^3 (Table 5.2)

h = the depth below ground surface, m

q = surcharge pressure at ground surface (if applicable), kPa.

**TABLE ERROR! NO TEXT OF SPECIFIED STYLE IN DOCUMENT..4
RECOMMENDED LATERAL EARTH PRESSURE PARAMETERS FOR VERTICAL WALLS**

SOIL LAYER	BULK UNIT WEIGHT, γ (kN/m^3)	COEFFICIENT OF LATERAL EARTH PRESSURE		
		K_a (ACTIVE)	K_o (AT REST)	K_p (PASSIVE)
		3H:1V	3H:1V	HORIZONTAL
Glaciolacustrine Clay	19	0.64	0.82	2.20
Clay Till with (with interbedded Sand/Silt)	19	0.47	0.70	2.77
Compacted Granular Fill	21	0.34	0.56	3.70

As discussed in Section 5.2, soils retained behind the two proposed walls are expected to comprise native glaciolacustrine clay. For Retaining Wall 1, soils below the wall base are expected to consist of glaciolacustrine clay, whereas, for Retaining Wall 2, soils below the wall base are expected to consist of clay till.

The magnitude of lateral earth pressure acting on the back of the wall depends on the tolerable movement/rotation of the wall. If the proposed cantilever walls can tolerate lateral movements at the wall top in the order of 1 percent of the design wall height (with regards to structural

performance, aesthetics, and integrity of any existing infrastructure behind the wall), an active earth pressure distribution may be used in wall design. If the wall cannot tolerate such movements, the design should be based on at-rest earth pressure conditions.

To mobilize the active or at-rest earth pressure coefficient of granular fill (if used), the granular fill behind the wall should form (as a minimum) a wedge-shaped zone delineated by projecting a 1H:1V line to ground surface from a point located 0.5 m into the soil from the base of the wall footing.

Relatively large wall movements are required to mobilize the full passive resistance of soils below the excavation base. In sizing the wall elements, it is recommended that the coefficients of passive earth pressure in Table 5.2 should be multiplied by a geotechnical resistance factor of at least 0.5 in order to limit movements.

The wall height considered in the design should account for temporary site grades during construction (e.g., to allow for the construction of the pavement section).

5.3.3 Retaining Wall Foundations

The proposed retaining walls can be supported on spread footings founded on the native undisturbed clay (Retaining Wall 1) or clay till (Retaining Wall 2) at a minimum embedment depth of 1.0 m below finished grade. It is also recommended that a layer of compacted granular fill, 300 mm thick, be placed beneath the wall footings for improved subgrade support. Any local zones of soft/wet or unsuitable soils at the base of wall excavation should also be sub-excavated and replaced with compacted granular fill or lean concrete.

The footings should be designed against three failure modes: bearing capacity, overturning, and sliding, as described in the following subsections.

5.3.3.1 Bearing Capacity

Bearing capacity evaluations for retaining wall footings are function of the shear strength of the foundation soil, wall embedment below grade, the width of the wall base, and the depth of the groundwater table below the wall base.

As noted in Section 5.2, the foundation soils beneath the base of Retaining Wall 1 is expected to consist of stiff clay and the groundwater level is likely deeper than 2 m below the underside of the footings. At the location of Retaining Wall 2, very stiff to hard clay till with interbedded sand/silt layers is expected below the wall foundation. The groundwater level is expected to be shallow. For design, it was assumed that the groundwater table coincides with the underside of the wall footings.

The short-term (undrained) and long-term (drained) ultimate bearing capacities of the wall footings were evaluated. The long-term bearing capacity was found to govern the design. The estimated ultimate bearing capacities of Retaining Walls 1 and 2 foundations are provided in Table 5.3 for varying footing widths. In Ultimate Limit State (ULS) design, the factored bearing resistance is equal to the ultimate bearing capacity (Table 5.3) times a geotechnical resistance factor (Φ) of 0.5.

**TABLE ERROR! NO TEXT OF SPECIFIED STYLE IN DOCUMENT..5
ESTIMATED ULTIMATE BEARING CAPACITY OF CONCRETE WALL FOOTINGS**

WIDTH OF WALL FOOTING, B (m)	ULTIMATE LONG-TERM BEARING CAPACITY (kPa)	
	RETAINING WALL 1 (CLAY FOUNDATION, GROUNDWATER 2.0 m BELOW UNDERSIDE OF FOOTING)	RETAINING WALL 2 (CLAY TILL FOUNDATION, GROUNDWATER AT UNDERSIDE OF FOOTING)
1.0	210	180
2.0	250	230
3.0	270	280
4.0	290	330

In sizing the wall footings using ULS design, an eccentrically loaded footing should be considered to have an effective concentrically loaded base of width B' , where $B' = B - 2e_B$, B is the width of the footing, and e_B is the eccentricity of the applied load in the B direction. The uniform, factored ULS bearing pressure at the base of the 'effective' footing should be less than the factored bearing resistance.

5.3.3.2 Overturning

To maintain the wall footing in full contact with the bearing soil and eliminate situations where zero contact pressure may exist beneath any portion of the footing, the Canadian Highway Bridge Design Code (2019) and the AASHTO LRFD Bridge Design Specifications (2014) require that the eccentricity of the factored ULS resultant force applied onto the base of the wall footing should be limited to one third the footing width (i.e., $B/3$). Additionally, the CFEM (2006) recommends limiting the eccentricity of the Serviceability Limit State resultant force applied onto the footing base, e_B , to a maximum of $B/6$.

5.3.3.3 Sliding

The sliding resistance of the concrete cantilever wall is governed by the shear resistance that can develop between the base of the wall and the foundation soil. The shear resistance at the wall base is governed by the width of the wall footing and the coefficient of friction ($\tan \delta$) between the footing base and the underlying foundation soils. For a clay foundation (Retaining Wall 1), a coefficient of friction of 0.4 may be used. For a clay till foundation (Retaining Wall 2), a coefficient of friction of 0.5 may be used. In ULS design, the factored driving force should be less than the ultimate shear resistance at the base of the wall footing multiplied by a geotechnical resistance factor of 0.8 (CFEM, 2006). Any live loads that may improve the sliding resistance of the wall should be neglected in the analysis.

In calculating the sliding resistance, the passive resistance of soils above the foundation level in front of the wall should be ignored because of potential disturbances due to freeze/thaw cycles and/or future excavations. If available sliding resistance is deemed insufficient, a shear key may be installed to enhance sliding resistance. In such a case, the passive earth pressure in front of the shear key may be used as described in Section 5.3.2.

5.3.4 Global Stability

For evaluating the global stability of the proposed walls, one cross section was analyzed at each wall site. The selected cross-sections corresponded to the maximum retained height and the highest backslope above the top of wall. The locations of the analyzed cross sections are shown on Drawing 30442.TDS2-1. Details of the selected sections are presented in Table 5.4. The design wall height in Table 5.4 is equal to the finished wall height plus 1.0 m of embedment depth.

**TABLE ERROR! NO TEXT OF SPECIFIED STYLE IN DOCUMENT..6
SUMMARY OF ANALYZED RETAINING WALL CROSS SECTIONS**

SECTION (DRAWING NO.)	INCLINATION OF BACKSLOPE (H:V)	MAXIMUM HEIGHT OF BACKSLOPE (m)	DESIGN WALL HEIGHT ¹ (m)
Retaining Wall 1; Sec B – B' (30442.TDS2-2)	3:1	5.3	2.2
Retaining Wall 2; Sec D – D' (30442.TDS2-4)	3:1	10.5	2.4

Cross section Drawings 30442.TDS2-2 and -4 are included in Appendix A

¹ Design wall height = finished height of wall facing + 1.0 m embedment.

Global stability analyses were performed using the SLOPE/W software by GEOSLOPE International Ltd., based on the method of limit equilibrium. The soil stratigraphy used in the analyses was determined from the results of the geotechnical site investigation completed in March/April 2021 and selected test holes from other investigations. The soil parameters and groundwater conditions described in Section 5.2 were adopted in the analyses. As the area atop the retaining wall is intended for landscaping purposes, no surcharge loads were applied at the ground surface above the tops of the walls.

The following target factors of safety were used to determine the design measures required to maintain the global stability of the concrete cantilever walls.

Short-Term Global Stability – minimum factor of safety = 1.3

Long-Term Global Stability – minimum factor of safety = 1.5

Global stability was checked for both short-term and long-term conditions. All computed factors of safety are within the criteria outlined above. Stability charts showing the results of the global stability analyses are presented in Appendix D.

5.3.5 Wall Settlement

Since the proposed retaining walls will be constructed in cut, no additional loads over and above the existing overburden stress are anticipated at the foundation level. As such, settlement of the proposed retaining walls is anticipated to be minimal.

5.3.6 Wall Drainage

The global stability evaluations and bearing capacities presented in the preceding sections were based on the assumption that the retaining wall will remain fully drained throughout its service life. Therefore, adequate drainage measures should be implemented to prevent the build-up of any hydrostatic water pressure behind the cantilever wall.

Such measures should include the use of compacted granular fill with no more than 5 percent fines (i.e., soil particles finer than 0.08 mm sieve) to backfill behind the walls. The entire backfill section may consist of granular material or, alternatively, a 1 m wide zone of granular fill may be placed directly behind the wall stem with the remainder of the excavation backfilled using compacted low to medium plastic clay or clay till. Perforated pipe subdrains, 150 mm diameter minimum, should also be installed along the wall alignment at the base of the wall. The base of the excavation should be graded towards the pipe subdrains at a minimum gradient of 2 percent. The pipe subdrains should be surrounded on all sides by washed rock (minimum 300 mm thick with no more than 5 percent silt and clay fraction) enveloped in non-woven geotextile fabric. The subdrains should be hydraulically connected to relief points, existing manholes, or stormwater drains to facilitate the removal of collected water. The drainage system should be installed in accordance with the manufacturer's recommendations.

In addition, a drainage swale should be installed behind the top of the wall to divert surface water away from the wall and prevent any ponding in the vicinity of the wall. The bottom of the drainage swale should be lined with compacted clay or geosynthetic membrane to prevent infiltration of surface water.

5.3.7 Protection Against Frost – Concrete Cantilever Walls

Freezing of retained soils can significantly increase lateral earth loads on retaining walls. To minimize frost effects, it is recommended that non-frost-susceptible granular material be used to backfill behind the retaining walls (either for the entire fill section or for a minimum 1 m wide zone immediately behind the wall stem) as discussed in Section 5.3.6.

As the wall footings will be founded within the frost penetration zone, some heave movements could occur. This is more of a concern for Retaining Wall 2 where silty fine sand is expected below the wall footing in some locations (refer to Drawing 30442.TDS2-3 in Appendix A) and the groundwater table is shallower. To minimize frost heave movement, extruded polystyrene rigid insulation can be installed in front of the wall. Styrofoam Highload 40 product (or approved equivalent) is recommended with a minimum insulation thickness of 150 mm. In order to be effective, the insulation should extend horizontally a sufficient distance in front of the wall. This could affect the performance of the roadway pavement adjacent to the wall and may require a transition zone between insulated and uninsulated pavements. A suitable insulation detail, taking

into account the potential impacts on roadway pavement, can be provided at a later date if the cantilever wall option is selected.

Concrete used in wall construction will be exposed to freezing and should, therefore, be adequately air entrained for improved durability.

5.3.8 Construction Footprint of Concrete Cantilever Walls

Excavations for the construction of the proposed cantilever walls will be undertaken through native clay and clay till. Layers of sand or silt interbedded within the clay till may also be encountered. The groundwater table is expected to be below the base of excavation.

The construction footprint required for the installation of the proposed cantilever walls may be estimated using temporary excavation slopes no steeper than 1H:1V in clay/clay till soils and 2.0H:1V in sand and silt soils. These temporary slopes are expected to be stable for short durations not exceeding 3 to 4 months. Where seepage zones are encountered within the sand or silt zones, flatter excavation slopes may be required. The crest of excavation slopes should be maintained a safe distance from existing property lines.

The above excavation slopes are provided for design purposes and are not to be construed as overriding the Alberta Occupational Health and Safety requirements. The Alberta Occupational Health and Safety Regulations and Code must be followed by the contractor(s) at all times.

Visual monitoring of the cut slopes should be conducted regularly during excavation and backfilling for signs of slope movement (e.g., sloughing, bulging, ground cracks, etc.).

Excavated soil and construction material should be kept back from the crest of the excavation slopes by a distance equal to at least 2 m or the depth of excavation, whichever is greater.

5.4 Shotcrete Retaining Wall with Ground Anchors

5.4.1 General

Shotcrete retaining walls with ground anchors have previously been used to support vertical cuts in Edmonton (e.g., the retaining wall on the south side of Fox Drive just west of Belgravia Road). The advantage of this wall system is that it can be built in a top-down manner with relatively small equipment. Top-down construction significantly reduces the construction footprint and the extent of backslope disturbance. It also minimizes the potential impacts of temporary excavations on existing structures and properties behind the wall. The application of shotcrete and ground anchors generally involves the following typical sequence:

1. The excavation is undertaken from the top-down in a series of benches typically about 1.5 to 2 m high depending on the soil conditions and design anchor spacing.
2. After each bench is excavated, ground anchors are drilled and installed.

3. Wire mesh and shotcrete is applied to the face of the excavation for temporary support. Additional reinforcing bars are typically provided around the anchor locations to strengthen the shotcrete against punching shear failure due to the anchor forces.
4. Once the grout of the anchors and the shotcrete have gained sufficient strength, the anchors are proof tested, pre-tensioned and then locked-off.
5. Next, benching is extended to the subsequent lower level and Steps 2 to 4 are repeated.
6. Geosynthetic strip drains should be provided behind the shotcrete as the excavation proceeds to provide continuous vertical wall drainage. The geosynthetic drains should be hydraulically connected to subdrains that run along the base of the wall to collect and discharge any seepage water.
7. Once the ground anchors and shotcrete facing are completed to the design grade, a permanent cast-in-place concrete facing is installed and structurally connected to the anchors. The concrete facing is typically supported on a small strip footing to resist the vertical components of the anchor forces.

5.4.2 Lateral Earth Pressure Distribution for Anchored Walls

When ground anchors are used as part of a retaining wall system, the lateral movement of the wall is reduced significantly due to the constraint provided by the anchor forces. As a result, higher lateral pressures than predicted by classical earth pressure theories develop behind the wall section above the design grade (or excavation line). The earth pressure distribution also tends to be more uniform with depth than the traditional triangular earth pressure distribution.

The design of shotcrete retaining walls with one level of ground anchors or multiple levels of ground anchors may be carried out using the trapezoidal earth pressure diagrams shown on Figure 5.1 and Figure 5.2, respectively. The earth pressure diagrams should be used in conjunction with the earth pressure coefficients and soil unit weights provided in Table 5.2 (Section 5.3.2). Since this wall system does not include any vertical components that extend below the design grade in front of the wall, the full earth pressure load should be resisted by the anchors.

If only one row of anchors is utilized in the design, it is recommended that the elevation of adjacent anchors vary along the wall alignment to improve the stability of the wall facing. Installing all anchors at the same elevation may cause the wall facing to rotate around the row of anchors, potentially causing stability problems.

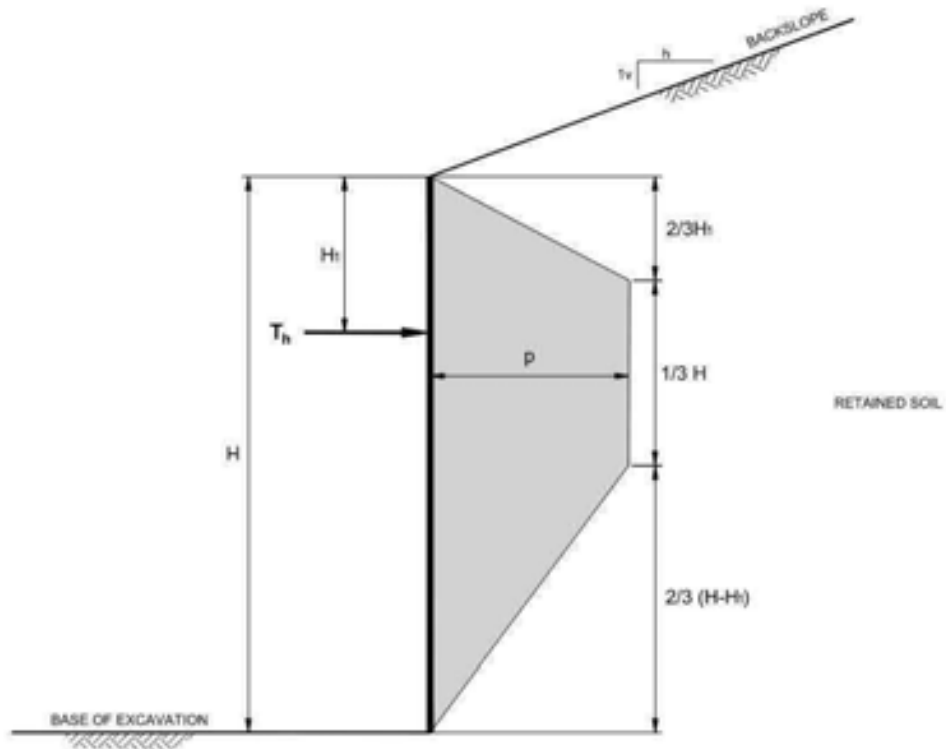

- H = WALL HEIGHT TO BASE OF EXCAVATION
- H₁ = DISTANCE FROM GROUND SURFACE TO GROUND ANCHOR
- T_h = HORIZONTAL LOAD IN GROUND ANCHOR
- p = MAXIMUM PRESSURE ORDINATE = K_a γ H (PER LINEAL METER OF WALL)
- K_a = COEFFICIENT OF ACTIVE EARTH PRESSURE; USE VALUES GIVEN IN TABLE 5.2 FOR GLACIOLACUSTRINE CLAY
- γ = SOIL UNIT WEIGHT

NOTES:

1. THE SELECTION OF THE DESIGN GRADE SHOULD TAKE INTO CONSIDERATION INTERIM CONSTRUCTION STAGES, IF APPLICABLE.
2. HYDROSTATIC WATER PRESSURE AND LATERAL PRESSURE DUE TO SURCHARGE LOADS AT THE GROUND SURFACE (IF APPLICABLE) SHOULD BE ADDED TO THE EARTH PRESSURE DIAGRAM ABOVE.
3. IN LIMIT STATES DESIGN, THE ACTIVE EARTH PRESSURE SHOULD BE MULTIPLIED BY AN APPROPRIATE LOAD FACTOR.

**RECOMMENDED EARTH PRESSURE DIAGRAM FOR DESIGN OF RETAINING WALL
WITH ONE LEVEL OF GROUND ANCHORS**

FIGURE 5.1
TRUBBER # 30442

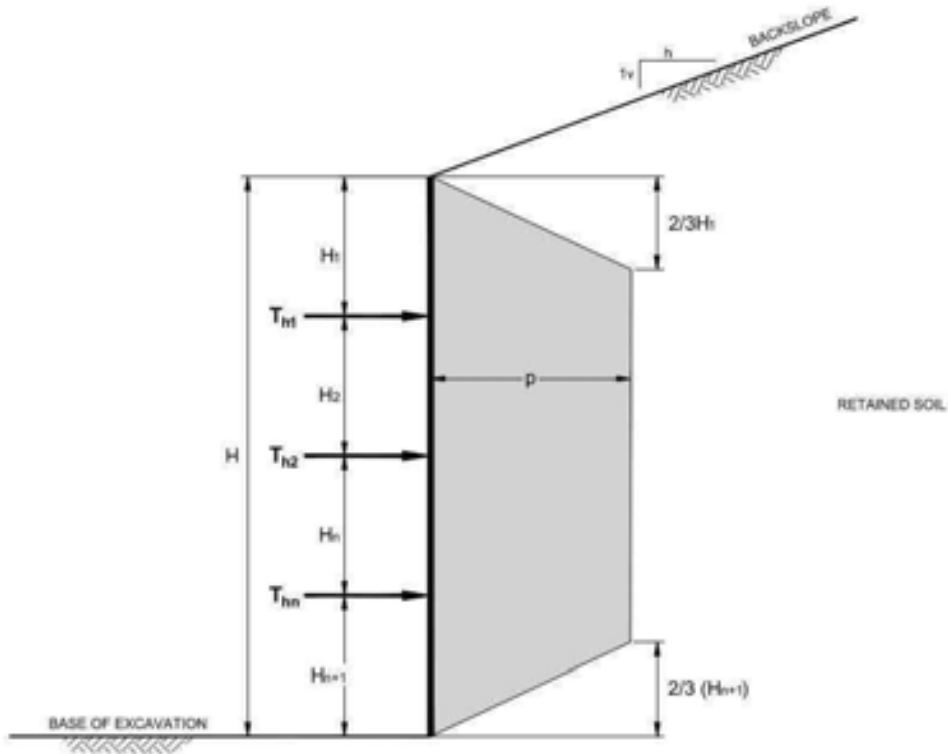

- H = WALL HEIGHT TO BASE OF EXCAVATION
- H₁ = DISTANCE FROM GROUND SURFACE TO GROUND ANCHOR
- H_{n+1} = DISTANCE FROM BASE OF EXCAVATION TO LOWERMOST GROUND ANCHOR
- T_{ht} = HORIZONTAL LOAD IN GROUND ANCHOR
- p = MAXIMUM PRESSURE ORDINATE = $0.65 K_a \gamma H^2 [(H+1/3)(H_1+H_{n+1})]$
- K_a = COEFFICIENT OF ACTIVE EARTH PRESSURE; USE VALUES GIVEN IN TABLE 5.2 FOR GLACIOLACUSTRINE CLAY
- γ = SOIL UNIT WEIGHT

NOTES:

1. THE SELECTION OF THE DESIGN GRADE SHOULD TAKE INTO CONSIDERATION INTERIM CONSTRUCTION STAGES, IF APPLICABLE.
2. HYDROSTATIC WATER PRESSURE AND LATERAL PRESSURE DUE TO SURCHARGE LOADS AT THE GROUND SURFACE (IF APPLICABLE) SHOULD BE ADDED TO THE EARTH PRESSURE DIAGRAM ABOVE.
3. IN LIMIT STATES DESIGN, THE ACTIVE EARTH PRESSURE SHOULD BE MULTIPLIED BY AN APPROPRIATE LOAD FACTOR.

**RECOMMENDED EARTH PRESSURE DIAGRAM FOR DESIGN OF RETAINING WALL
WITH MULTIPLE LEVELS OF GROUND ANCHORS**

FIGURE 5.2
THURBER # 30442

5.4.3 Anchor Design

Figure 5.3 provides the recommended minimum spacing and depth of ground anchors. From a constructability point of view, anchors can be installed as long as 50 m with inclinations ranging from 10 to 35 degrees from the horizontal. Consideration should, however, be given to limiting the length of anchors (if feasible) to avoid any intrusions below the residential properties at the crest of the existing cut slopes of Terwillegar Drive and Whitemud Drive. Based on the information provided by CIMA+, it is estimated that the property limits are located approximately 13 to 22 m behind the face of Retaining Wall 1 and approximately 33 to 42 m behind the face of Retaining Wall 2.

The diameter of anchor drill holes can range from 150 to 225 mm, with a 200 mm diameter being the most common. The length of bond zone should not exceed 12 m. The unbonded length of the anchor should not be less than 4.5 m for strand anchors and 3.0 m for bar anchors. Anchors should be separated by at least four bond diameters. All anchor drill holes will require casing as non-cohesive soils below the water table are possible at both wall locations.

Permanent anchor tendons should have double corrosion protection; Class I protection in accordance with the recommendations of the Post-Tensioning Institute (PTI DC35.1-14). Dywidag bar tendons or an equivalent product may be used. Typical Dywidag bar sizes range from 26 to 36 mm. Although strand tendons are feasible, the use of bar tendons is preferred as they are easier to install and are more common in Alberta.

The anchor grout should have a water to cement ratio between 0.40 to 0.45 and a minimum compressive strength of 35 MPa at 28 days.

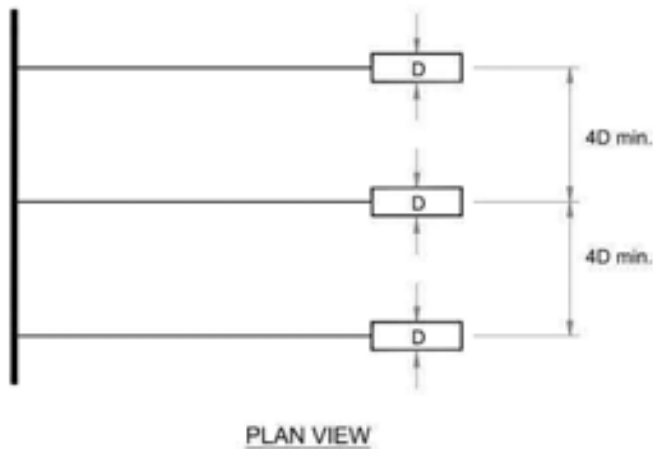
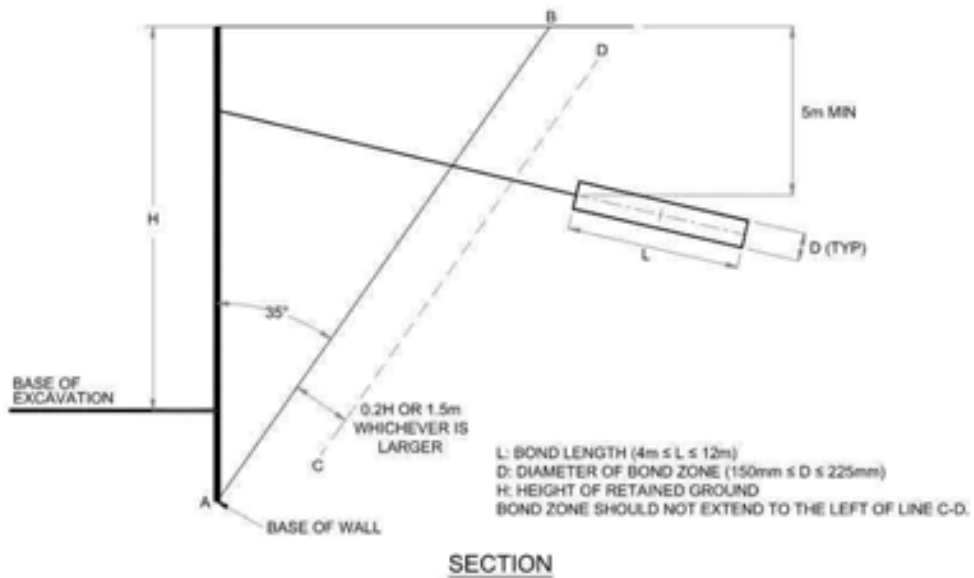

**MINIMUM SPACING AND DEPTH
FOR SOIL ANCHORS**

FIGURE 5.3
THURBER # 30442

5.4.4 Grout Bond Resistance

The pullout capacity, P_{ar} , of individual anchors can be determined by applying the factored ULS bond resistances presented in Table 5.5 to the surface area of the bond length given by " $\pi \cdot D \cdot L$ " where D is the anchor nominal diameter and L is the bond length in the respective soil layers in Table 5.5. It should be noted that the estimated factored ULS bond resistance incorporates a geotechnical resistance factor of 0.6 based on the assumption that an adequate load testing program will be conducted to verify the ultimate load carrying capacity of the anchors, as outlined in Section 5.4.5. It is anticipated that pressure grouting, and possibly post-grouting, could be necessary to achieve the specified ultimate bond resistances.

**TABLE ERROR! NO TEXT OF SPECIFIED STYLE IN DOCUMENT..7
RECOMMENDED GEOTECHNICAL VALUES FOR PRESSURE GROUTED ANCHORS**

MATERIAL TYPE	BOND RESISTANCE (kPa)	
	ULTIMATE RESISTANCE	FACTORED RESISTANCE ($\Phi = 0.6$)
Glaciolacustrine Clay	50	30
Clay Till with (with interbedded Sand/Silt)	100	60

5.4.5 Load Testing of Anchors

The ultimate bond resistance and the creep behavior of ground anchors should be verified by performing pre-production load tests on sacrificial anchors. The test anchors should be installed in the same soil unit(s) and using the same methods and equipment as the production anchors. The configuration of the test anchors and test loads should be such that the ultimate bond resistance of the grout-soil interface can be mobilized. This may require oversizing the tendon of the pre-production anchors to accommodate the ultimate pullout capacity. Depending on the results of the load test, anchor lengths and/or layouts may need to be adjusted. In addition, performance tests should also be conducted on a minimum of 10 percent of the production anchors. Proof tests should be performed on all other production anchors. The anchor load tests, and acceptance criteria should be in accordance with the recommendations of PTI DC35.1-14. None of the anchor load tests should be performed until the grout strength has reached at least 80 percent of the specified 28-day compressive strength.

5.4.6 Global Stability

The global stability of the anchored retaining wall should be checked once the anchor layout has been established in order to confirm that the global factors of safety exceed the target values. The recommended target factors of safety are:

Short-Term Global Stability – minimum factor of safety = 1.3

Long-Term Global Stability – minimum factor of safety = 1.5.

The results of the long-term global stability analyses of the cantilever retaining walls (Section 5.3.4) indicated that the long-term factors of safety exceed the above target values. The factors of safety for the global stability of the anchored wall system are anticipated to be even higher due to the anchor forces that will be applied to the slope.

5.4.7 Anchored Wall Drainage

Adequate wall drainage is essential to prevent the buildup of water pressure behind the wall and to minimize frost effects. To facilitate wall drainage, it is recommended that geocomposite strip drains, at least 1.0 m in width, be installed directly against soils exposed at the excavation face. The drains should have sufficient capacity to remove any water that may collect/infiltrate behind the wall and should be continuous from top to bottom. Where it is necessary to splice drainage strips, a minimum overlap of 400 mm should be maintained.

The strip drains should be hydraulically connected to a perforated subdrain at the base of the wall to direct the collected water away from the wall area. The subdrain should comprise a 150 mm diameter perforated pipe surrounded on all sides by washed rock (minimum 300 mm thick with no more than five percent silt and clay fraction) encased in non-woven geotextile. The subdrain should be hydraulically connected to relief points or existing stormwater drains to facilitate the removal of collected water. The drainage system should be installed in accordance with the manufacturer's recommendations.

Surface water should not be allowed to pond at the top of wall. To facilitate drainage of surface water, a drainage swale should be provided behind the wall along the toe of the backslope. The swale should collect surface water and direct it to a positive discharge point away from the wall.

5.4.8 Protection Against Frost – Anchored Wall

Freezing of soils retained behind the shotcrete walls can significantly increase the loads resisted by the shotcrete and anchors. To minimize the risk of soil freezing, it is recommended that extruded polystyrene rigid insulation be installed between the shotcrete and the final wall facing. Styrofoam Highload 40 product (or approved equivalent) is recommended with a minimum insulation thickness of 150 mm. To minimize frost penetration at the wall top, the insulation should also be placed below the backslope above the top of wall and should extend up slope a minimum distance of 2.4 m from the back side of the shotcrete. The insulation should be installed in accordance with the manufacturer's recommendations.

Concrete used in wall construction will be exposed to freezing and should, therefore, be adequately air entrained for improved durability.

5.4.9 Anchored Wall Footing

The permanent cast-in-place concrete facing of the proposed walls can be supported on strip footings founded on the native undisturbed clay (Retaining Wall 1) or clay till (Retaining Wall 2) at a minimum embedment depth of 1.0 m below finished grade. The footings should be sized based on the estimated bearing capacities presented in Section 5.3.3.1.

5.5 Future Investigations

It is important to emphasize that the geotechnical assessments and recommendations presented in this report were based on limited geotechnical information from previous investigations. They are intended to support the preliminary design of the two proposed retaining walls but are deemed insufficient for the detailed design of the proposed structures.

Prior to proceeding with the detailed designs of the walls, it is recommended that site-specific geotechnical investigations should be carried out to better characterize the subsurface conditions at the wall locations and confirm the findings and design recommendations presented in this report.

6. LIMITATIONS OF STUDY

This letter was issued before any final design or construction details had been prepared or issued. Therefore, differences may exist between the letter recommendations and the final design, the contract documents, or during construction. In such instances, Thurber Engineering Ltd. should be contacted immediately to address these differences. Designers and contractors undertaking or bidding the work should examine the factual results of the investigation, satisfy themselves as to the adequacy of the information for design and construction, and make their own interpretation of the data as it may affect their proposed scope of work, cost, schedules, and safety and equipment capabilities.

7. REFERENCES

AASHTO, 2014. LRFD Bridge Design Specifications.

CFEM. 2006. Canadian Foundation Engineering Manual. 4th ed. Canadian Geotechnical Society, BiTech Publisher Ltd., Canada.

Canadian Standard Association (CSA). 2019. CSA S6:19 Canadian Highway Bridge Design Code. CSA Group, Toronto, Ontario, Canada.

Federal Highway Administration (FHWA). 2002. Geotechnical Engineering Circular No. 6: Shallow Foundations.

Post-Tensioning Institute (PTI). 2014. DC35.1-14 Recommendations for Prestressed Rock and Soil Anchors.

8. CLOSURE

We trust this information meets your present needs. If you have any questions, please contact the undersigned at your convenience.

Yours truly,
Thurber Engineering Ltd.
Hassan El-Ramly, PhD., P.Eng.
Geotechnical Review Principal

Ben Reich, M.Eng., P.Eng.
Geotechnical Engineer
/jf

Attachments:

- Statement of Limitations and Conditions
- Appendix A – Drawings – Test Hole Location Plan and Cross Sections
- Appendix B – Symbols and Terms Used in Test Hole Logs, Modified Unified Soils Classification, Test Hole Logs (Recent and Historic)
- Appendix C – Laboratory Test Results
- Appendix D – Global Stability Analysis Results



STATEMENT OF LIMITATIONS AND CONDITIONS

1. STANDARD OF CARE

This Report has been prepared in accordance with generally accepted engineering or environmental consulting practices in the applicable jurisdiction. No other warranty, expressed or implied, is intended or made.

2. COMPLETE REPORT

All documents, records, data and files, whether electronic or otherwise, generated as part of this assignment are a part of the Report, which is of a summary nature and is not intended to stand alone without reference to the instructions given to Thurber by the Client, communications between Thurber and the Client, and any other reports, proposals or documents prepared by Thurber for the Client relative to the specific site described herein, all of which together constitute the Report.

IN ORDER TO PROPERLY UNDERSTAND THE SUGGESTIONS, RECOMMENDATIONS AND OPINIONS EXPRESSED HEREIN, REFERENCE MUST BE MADE TO THE WHOLE OF THE REPORT. THURBER IS NOT RESPONSIBLE FOR USE BY ANY PARTY OF PORTIONS OF THE REPORT WITHOUT REFERENCE TO THE WHOLE REPORT.

3. BASIS OF REPORT

The Report has been prepared for the specific site, development, design objectives and purposes that were described to Thurber by the Client. The applicability and reliability of any of the findings, recommendations, suggestions, or opinions expressed in the Report, subject to the limitations provided herein, are only valid to the extent that the Report expressly addresses proposed development, design objectives and purposes, and then only to the extent that there has been no material alteration to or variation from any of the said descriptions provided to Thurber, unless Thurber is specifically requested by the Client to review and revise the Report in light of such alteration or variation.

4. USE OF THE REPORT

The information and opinions expressed in the Report, or any document forming part of the Report, are for the sole benefit of the Client. NO OTHER PARTY MAY USE OR RELY UPON THE REPORT OR ANY PORTION THEREOF WITHOUT THURBER'S WRITTEN CONSENT AND SUCH USE SHALL BE ON SUCH TERMS AND CONDITIONS AS THURBER MAY EXPRESSLY APPROVE. Ownership in and copyright for the contents of the Report belong to Thurber. Any use which a third party makes of the Report, is the sole responsibility of such third party. Thurber accepts no responsibility whatsoever for damages suffered by any third party resulting from use of the Report without Thurber's express written permission.

5. INTERPRETATION OF THE REPORT

- a) Nature and Exactness of Soil and Contaminant Description: Classification and identification of soils, rocks, geological units, contaminant materials and quantities have been based on investigations performed in accordance with the standards set out in Paragraph 1. Classification and identification of these factors are judgmental in nature. Comprehensive sampling and testing programs implemented with the appropriate equipment by experienced personnel may fail to locate some conditions. All investigations utilizing the standards of Paragraph 1 will involve an inherent risk that some conditions will not be detected and all documents or records summarizing such investigations will be based on assumptions of what exists between the actual points sampled. Actual conditions may vary significantly between the points investigated and the Client and all other persons making use of such documents or records with our express written consent should be aware of this risk and the Report is delivered subject to the express condition that such risk is accepted by the Client and such other persons. Some conditions are subject to change over time and those making use of the Report should be aware of this possibility and understand that the Report only presents the conditions at the sampled points at the time of sampling. If special concerns exist, or the Client has special considerations or requirements, the Client should disclose them so that additional or special investigations may be undertaken which would not otherwise be within the scope of investigations made for the purposes of the Report.
- b) Reliance on Provided Information: The evaluation and conclusions contained in the Report have been prepared on the basis of conditions in evidence at the time of site inspections and on the basis of information provided to Thurber. Thurber has relied in good faith upon representations, information and instructions provided by the Client and others concerning the site. Accordingly, Thurber does not accept responsibility for any deficiency, misstatement or inaccuracy contained in the Report as a result of misstatements, omissions, misrepresentations, or fraudulent acts of the Client or other persons providing information relied on by Thurber. Thurber is entitled to rely on such representations, information and instructions and is not required to carry out investigations to determine the truth or accuracy of such representations, information and instructions.
- c) Design Services: The Report may form part of design and construction documents for information purposes even though it may have been issued prior to final design being completed. Thurber should be retained to review final design, project plans and related documents prior to construction to confirm that they are consistent with the intent of the Report. Any differences that may exist between the Report's recommendations and the final design detailed in the contract documents should be reported to Thurber immediately so that Thurber can address potential conflicts.
- d) Construction Services: During construction Thurber should be retained to provide field reviews. Field reviews consist of performing sufficient and timely observations of encountered conditions in order to confirm and document that the site conditions do not materially differ from those interpreted conditions considered in the preparation of the report. Adequate field reviews are necessary for Thurber to provide letters of assurance, in accordance with the requirements of many regulatory authorities.

6. RELEASE OF POLLUTANTS OR HAZARDOUS SUBSTANCES

Geotechnical engineering and environmental consulting projects often have the potential to encounter pollutants or hazardous substances and the potential to cause the escape, release or dispersal of those substances. Thurber shall have no liability to the Client under any circumstances, for the escape, release or dispersal of pollutants or hazardous substances, unless such pollutants or hazardous substances have been specifically and accurately identified to Thurber by the Client prior to the commencement of Thurber's professional services.

7. INDEPENDENT JUDGEMENTS OF CLIENT

The information, interpretations and conclusions in the Report are based on Thurber's interpretation of conditions revealed through limited investigation conducted within a defined scope of services. Thurber does not accept responsibility for independent conclusions, interpretations, interpolations and/or decisions of the Client, or others who may come into possession of the Report, or any part thereof, which may be based on information contained in the Report. This restriction of liability includes but is not limited to decisions made to develop, purchase or sell land.

APPENDIX A

Drawings – Test Hole Location Plan and Cross Sections

DRAFT

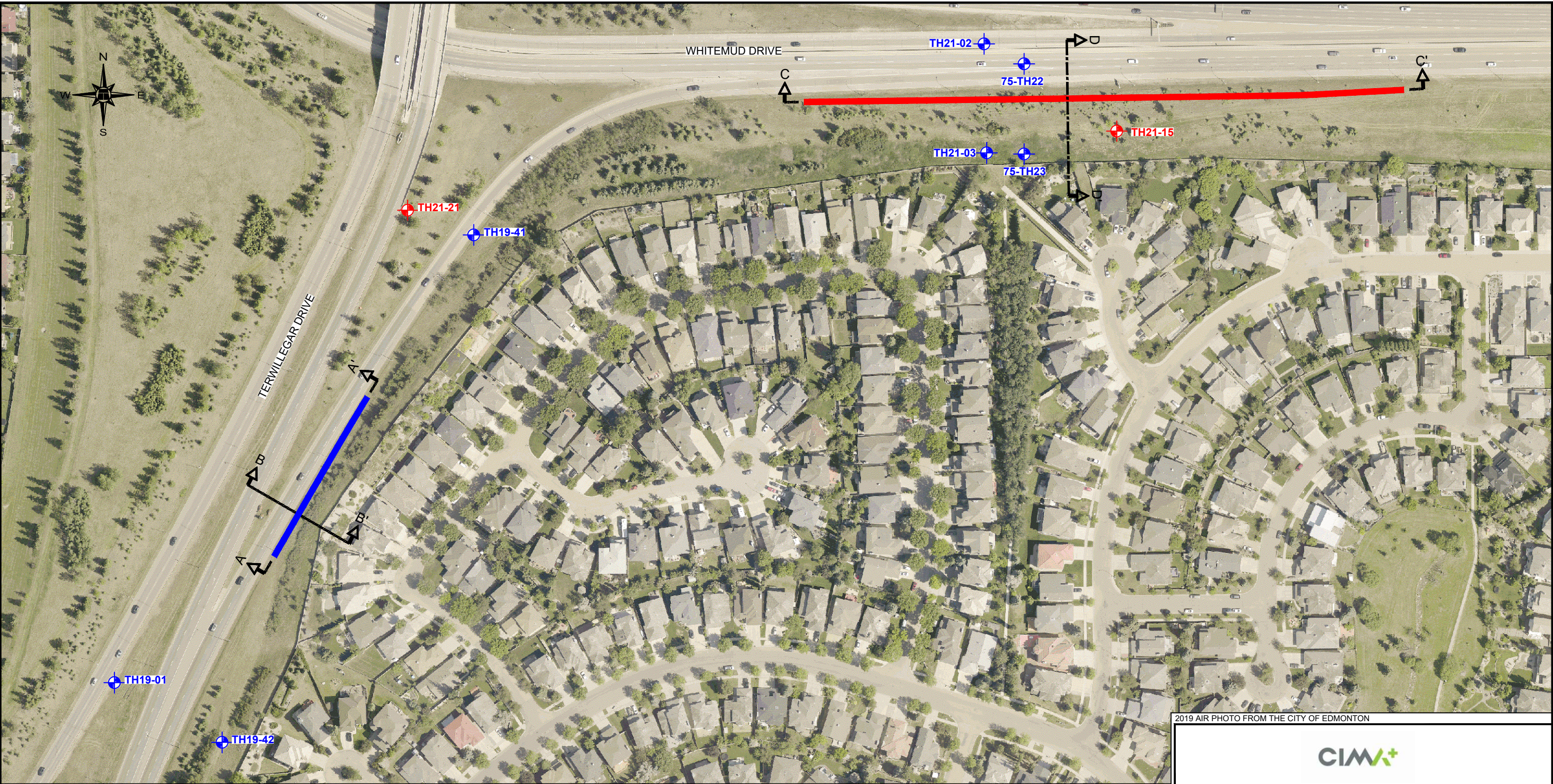

2019 AIR PHOTO FROM THE CITY OF EDMONTON







**TERWILLEGAR DRIVE UPGRADING STAGE 2 PRELIMINARY
ENGINEERING - RETAINING WALLS EAST OF
TERWILLEGAR DRIVE AND SOUTH OF WHITEMUD DRIVE**

**SITE PLAN SHOWING APPROXIMATE
TEST HOLE LOCATIONS**

DWG No. 30442.TDS2-1

LEGEND

-  APPROXIMATE TEST HOLE LOCATION (2021 TERWILLEGAR DRIVE - STAGE 2 GEOTECHNICAL INVESTIGATION)
-  APPROXIMATE TEST HOLE LOCATION (OTHER GEOTECHNICAL INVESTIGATIONS)
-  RETAINING WALL 1
-  RETAINING WALL 2

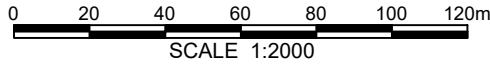

DRAWN BY	ML
DESIGNED BY	BR
APPROVED BY	HER
SCALE	1:2000
DATE	AUGUST 2021
FILE No.	30442



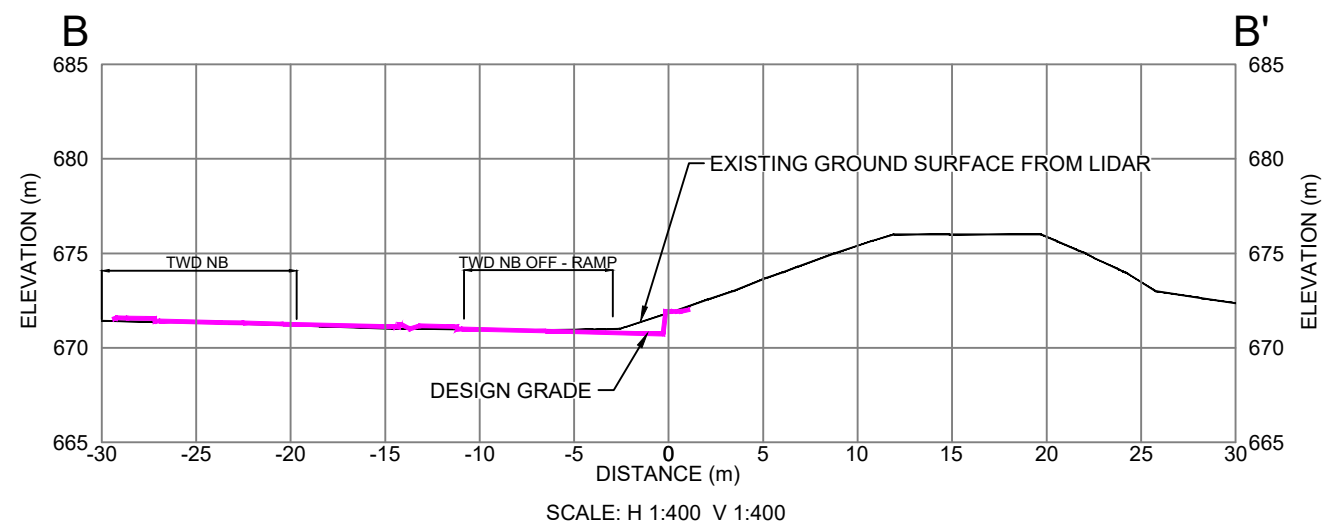
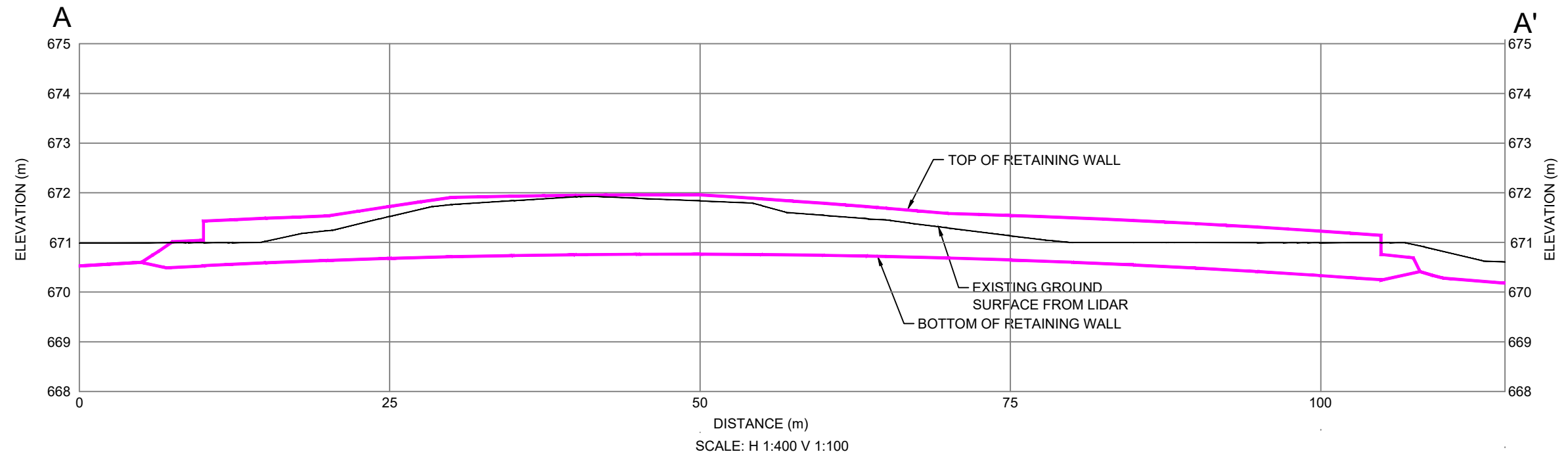

LEGEND

TWD NB TERWILLEGAR DRIVE NORTHBOUND

NOTE

GROUND SURFACE PROFILES ARE FROM 2019 LIDAR.



**TERWILLEGAR DRIVE UPGRADING STAGE 2 PRELIMINARY
ENGINEERING - RETAINING WALLS EAST OF
TERWILLEGAR DRIVE AND SOUTH OF WHITEMUD DRIVE**

**RETAINING WALL 1
CROSS - SECTIONS A - A' AND B - B'**



DWG No. 30442.TDS2-2

DRAWN BY	ML
DESIGNED BY	BR
APPROVED BY	HER
SCALE	AS SHOWN
DATE	AUGUST 2021
FILE No.	30442

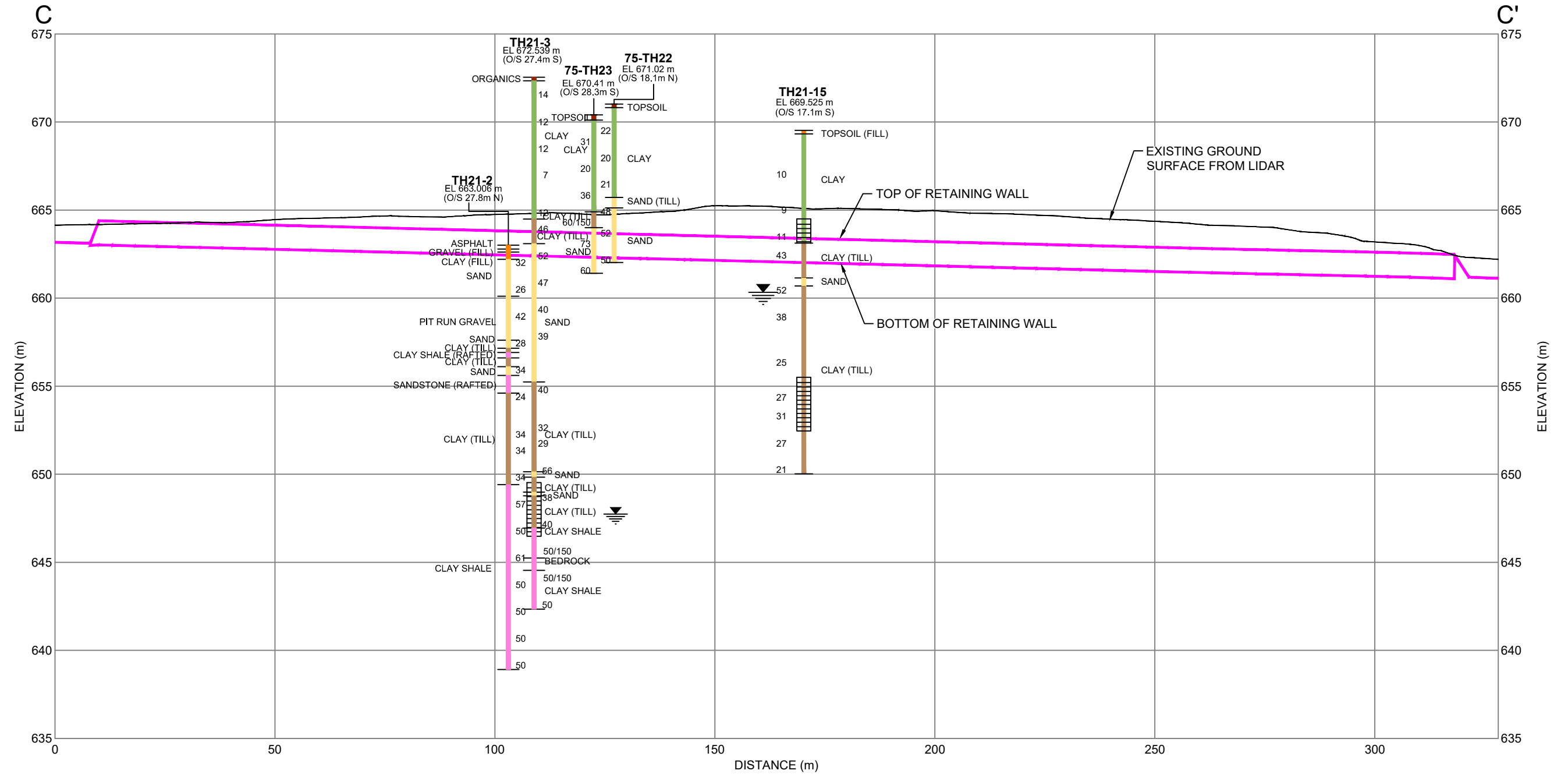



LEGEND

-  SPT N VALUE
-  WATER LEVEL IN PIEZOMETER (JULY 2021)
-  STANDPIPE PIEZOMETER SCREENED INTERVAL

NOTE

1. DATA CONCERNING THE VARIOUS STRATA HAVE BEEN OBTAINED AT THE TEST HOLE LOCATIONS ONLY. THE SOIL STRATIGRAPHY BETWEEN TEST HOLES HAS BEEN INFERRED FROM GEOLOGICAL EVIDENCE AND SO MAY VARY FROM THAT SHOWN.
2. GROUND SURFACE PROFILE IS FROM 2019 LIDAR.



**TERWILLEGAR DRIVE UPGRADING STAGE 2 PRELIMINARY
ENGINEERING - RETAINING WALLS EAST OF
TERWILLEGAR DRIVE AND SOUTH OF WHITEMUD DRIVE**

**RETAINING WALL 2
STRATIGRAPHIC CROSS - SECTION C - C'**

DWG No. 30442.TDS2-3

DRAWN BY	ML
DESIGNED BY	BR
APPROVED BY	HER
SCALE	H 1:1000 V 1:250
DATE	AUGUST 2021
FILE No.	30442



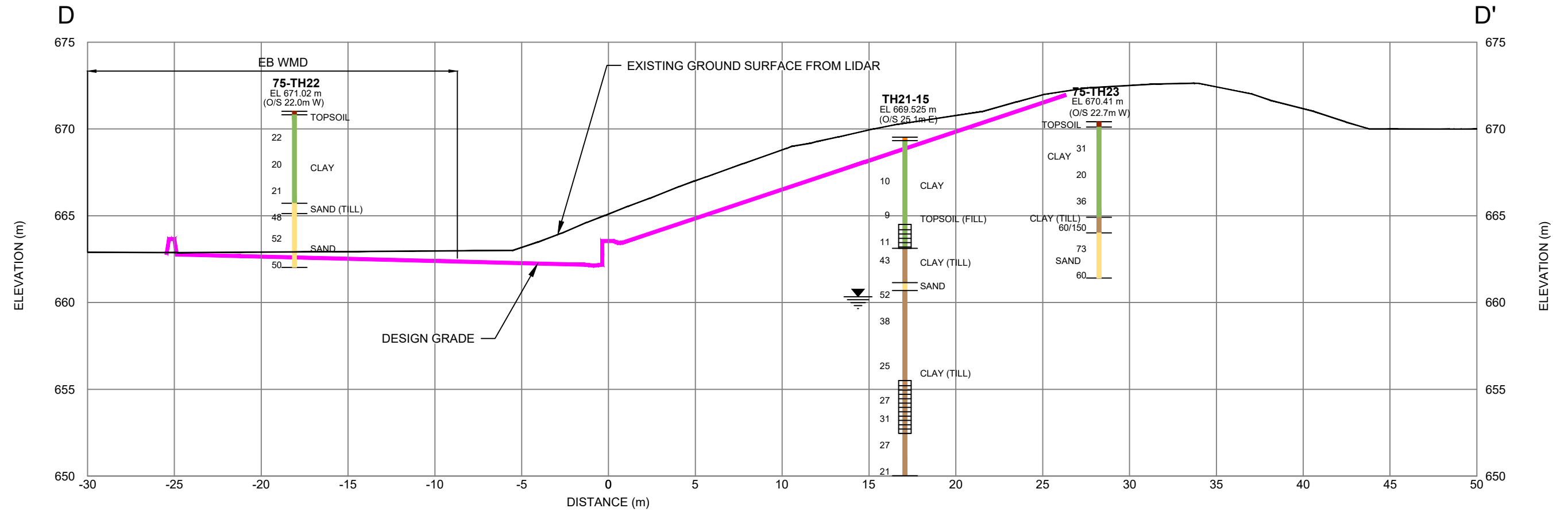

LEGEND

- SPT N VALUE
- WATER LEVEL IN PIEZOMETER (JULY 2021)
- STANDPIPE PIEZOMETER SCREENED INTERVAL

EB WMD EASTBOUND WHITEMUD DRIVE

NOTE

1. DATA CONCERNING THE VARIOUS STRATA HAVE BEEN OBTAINED AT THE TEST HOLE LOCATIONS ONLY. THE SOIL STRATIGRAPHY BETWEEN TEST HOLES HAS BEEN INFERRED FROM GEOLOGICAL EVIDENCE AND SO MAY VARY FROM THAT SHOWN.
2. GROUND SURFACE PROFILE IS FROM 2019 LIDAR.



TERWILLEGAR DRIVE UPGRADING STAGE 2 PRELIMINARY ENGINEERING - RETAINING WALLS EAST OF TERWILLEGAR DRIVE AND SOUTH OF WHITEMUD DRIVE

**RETAINING WALL 2
STRATIGRAPHIC CROSS - SECTION D - D'**

DWG No. 30442.TDS2-4

DRAWN BY	ML
DESIGNED BY	BR
APPROVED BY	HER
SCALE	1:250
DATE	AUGUST 2021
FILE No.	30442



APPENDIX B

Symbols and Terms Used in Test Hole Logs

Modified Unified Soils Classification

Test Hole Logs (Recent and Historic)

DRAFT

SYMBOLS AND TERMS USED ON TEST HOLE LOGS

1. VISUAL TEXTURAL CLASSIFICATION OF MINERAL SOILS

<u>CLASSIFICATION</u>	<u>APPARENT PARTICLE SIZE</u>	<u>VISUAL IDENTIFICATION</u>
Boulders	Greater than 200 mm	Greater than 200 mm
Cobbles	75 mm to 200 mm	75 mm to 200 mm
Gravel	4.75 mm to 75 mm	5 mm to 75 mm
Sand	0.075 mm to 4.75 mm	Visible particles to 5 mm
Silt	0.002 mm to 0.075 mm	Non-Plastic particles, not visible to the naked eye
Clay	Less than 0.002 mm	Plastic particles, not visible to the naked eye

2. TERMS DESCRIBING CONSISTENCY (COHESIVE SOILS ONLY)

<u>DESCRIPTIVE TERM</u>	<u>APPROXIMATE UNDRAINED SHEAR STRENGTH</u>	<u>APPROXIMATE SPT * 'N' VALUE</u>
Very Soft	Less than 10 kPa	Less than 2
Soft	10 - 25 kPa	2 to 4
Firm	25 - 50 kPa	4 to 8
Stiff	50 - 100 kPa	8 to 15
Very Stiff	100 - 200 kPa	15 to 30
Hard	200 - 300 kPa	Greater than 30
Very Hard	Greater than 300 kPa	

} Modified from National Building Code

* SPT 'N' Value Standard Penetration Test 'N' Value - refers to the number of blows from a 63.5 kg hammer free falling a height of 0.76m to advance a standard 50mm outside diameter split spoon sampler for 0.3m depth into the undrilled portion of the test hole.







3. TERMS DESCRIBING DENSITY (COHESIONLESS SOILS ONLY)

<u>DESCRIPTIVE TERM</u>	<u>STANDARD PENETRATION TEST (SPT) (Number of Blows per 300 mm)</u>
Very Loose	0 - 4
Loose	4 - 10
Compact	10 - 30
Dense	30 - 50
Very Dense	Over 50

} Modified from National Building Code

4. LEGEND FOR TEST HOLE LOGS

SYMBOL FOR SAMPLE TYPE

 Shelby Tube	 SPT	 No Recovery	 A-Casing	 Grab	 Core
---	---	---	--	--	--

SYMBOLS USED FOR TEST HOLE LOGS

●	WC - Water Content (% by weight) of soil sample
▼	Water Level
■	SPT Standard Penetration Test 'N' Value (Blows/300mm)
▲	CPen Shear Strength determined by pocket penetrometer
CVane	Shear Strength determined by pocket vane
Cu	Undrained Shear Strength determined by unconfined compression test
SO ₄ %	Percent (%) of water soluble sulphate ions

TERMS DESCRIBING QUANTITIES

'and'	35% to 50% of each size group
'sandy'	20% to 35%
'some'	10% to 20%
'trace'	Less than 10%
'mixture'	Soils containing three or more size groups within 20% of each other and each group greater than 10%

MODIFIED UNIFIED CLASSIFICATION SYSTEM FOR SOILS

(MODIFIED BY PFRA, 1985)

MAJOR DIVISION		GROUP SYMBOL	THURBER LOG SYMBOL	TYPICAL DESCRIPTION	LABORATORY CLASSIFICATION CRITERIA			
COARSE-GRAINED SOILS (MORE THAN HALF BY WEIGHT LARGER THAN 75µm)	GRAVELS MORE THAN HALF COARSE GRAINS LARGER THAN 4.75mm	GW	▲ ▼ ▲ ▲ ▼ ▲ ▲ ▼ ▲	WELL GRADED GRAVELS, GRAVEL-SAND MIXTURES, LITTLE OR NO FINES	$C_u = \frac{D_{60}}{D_{10}} > 4; C_c = \frac{(D_{30})^2}{D_{10} \times D_{60}} = 1 \text{ to } 3$ NOT MEETING ALL GRADATION REQUIREMENTS FOR GW ATTERBERG LIMITS BELOW "A" LINE I_p LESS THAN 4 ATTERBERG LIMITS ABOVE "A" LINE I_p MORE THAN 7 $C_u = \frac{D_{60}}{D_{10}} > 6; C_c = \frac{(D_{30})^2}{D_{10} \times D_{60}} = 1 \text{ to } 3$ NOT MEETING ALL GRADATION REQUIREMENTS FOR SW ATTERBERG LIMITS BELOW "A" LINE I_p LESS THAN 4 ATTERBERG LIMITS ABOVE "A" LINE I_p MORE THAN 7			
		GP	▲▲▲▲▲ ▲▲▲▲▲ ▲▲▲▲▲	POORLY GRADED GRAVELS, GRAVEL-SAND MIXTURES, LITTLE OR NO FINES				
		GRAVELS WITH FINES (APPRECIABLE AMOUNT OF FINES)	GM	▲▲▲▲▲ ▲▲▲▲▲ ▲▲▲▲▲		SILTY GRAVELS, GRAVEL-SAND-SILT MIXTURES		
			GC	▲▲▲▲▲ ▲▲▲▲▲ ▲▲▲▲▲		CLAYEY GRAVELS, GRAVEL-SAND-CLAY MIXTURES		
	SANDS MORE THAN HALF COARSE GRAINS SMALLER THAN 4.75mm	SW	● ● ● ● ● ● ● ● ● ● ● ● ● ● ●	WELL GRADED SANDS, GRAVELLY-SANDS, LITTLE OR NO FINES				
		SP	○○○○○ ○○○○○ ○○○○○	POORLY GRADED SANDS, GRAVELLY SANDS, LITTLE OR NO FINES				
		SAND WITH FINES (APPRECIABLE AMOUNT OF FINES)	SM	○○○○○ ○○○○○ ○○○○○		SILTY SANDS, SAND-SILT MIXTURES		
			SC	○○○○○ ○○○○○ ○○○○○		CLAYEY SANDS, SAND-CLAY MIXTURES		
		FINE-GRAINED SOILS (MORE THAN HALF BY WEIGHT SMALLER THAN 75µm)	SILTS BELOW "A" LINE NEGLECTIBLE ORGANIC CONTENT	$w_L < 50\%$		ML	INORGANIC SILTS AND VERY FINE SANDS, ROCK FLOUR, SILTY OR CLAYEY FINE SANDS OR CLAYEY SILTS WITH SLIGHT PLASTICITY	CLASSIFICATION IS BASED UPON PLASTICITY CHART (see below)
				$w_L > 50\%$		MH	INORGANIC SILTS, MICACEOUS OR DIATOMACEOUS, FINE SANDY OR SILTY SOILS	
CLAYS ABOVE "A" LINE NEGLECTIBLE ORGANIC CONTENT	$w_L < 30\%$		CL	INORGANIC CLAYS OF LOW PLASTICITY, GRAVELLY, SANDY, OR SILTY CLAYS, LEAN CLAYS				
	$30\% < w_L < 50\%$		CI	INORGANIC CLAYS OF MEDIUM PLASTICITY, GRAVELLY CLAYS, SANDY CLAYS, SILTY CLAYS				
	$w_L > 50\%$		CH	INORGANIC CLAYS OF HIGH PLASTICITY, FAT CLAYS				
ORGANIC SILTS & CLAYS BELOW "A" LINE	$w_L < 50\%$		OL	ORGANIC SILTS AND ORGANIC SILTY CLAYS OF LOW AND MEDIUM PLASTICITY				
	$w_L > 50\%$	OH	ORGANIC CLAYS OF HIGH PLASTICITY, ORGANIC SILTS					
HIGHLY ORGANIC SOILS		Pt	PEAT AND OTHER HIGHLY ORGANIC SOILS	STRONG COLOR OR ODOR, AND OFTEN FIBROUS TEXTURE				

Determine percentages of gravel and sand from grain size curve. Depending on percentages of fines (fraction smaller than 75µm) coarse grained soils are classified as follows:
 Less than 5% GW, GP, SW, SP
 More than 5% GM, GC, SM, SC
 5% to 12% Borderline cases requiring use of dual symbols

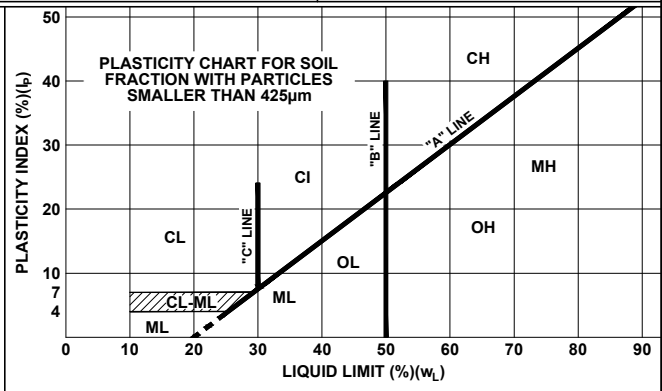
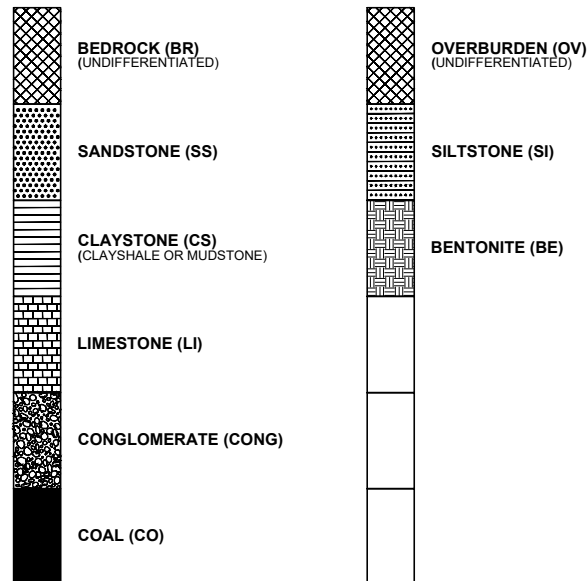

MODIFIED UNIFIED CLASSIFICATION SYSTEM FOR SOILS
(MODIFIED BY PFRA, 1985)

CLIENT: CIMA+	PROJECT: TERWILLEGAR DRIVE UPGRADING STAGE 2	BOREHOLE NO: TH21-15
DRILLING COMPANY: ALL SERVICE DRILLING INC	DATE DRILLED: March 30, 2021	PROJECT NO: 30442
DRILL/METHOD: D50 Track / Solid Stem Augers	LOCATION: N5927767.718, E28884.592	ELEVATION: 669.53 (m)

SAMPLE TYPE	<input type="checkbox"/> GRAB SAMPLE	<input checked="" type="checkbox"/> SPT	<input checked="" type="checkbox"/> SHELBY TUBE
BACKFILL TYPE	<input checked="" type="checkbox"/> BENTONITE	<input checked="" type="checkbox"/> DRILL CUTTINGS	<input type="checkbox"/> SAND

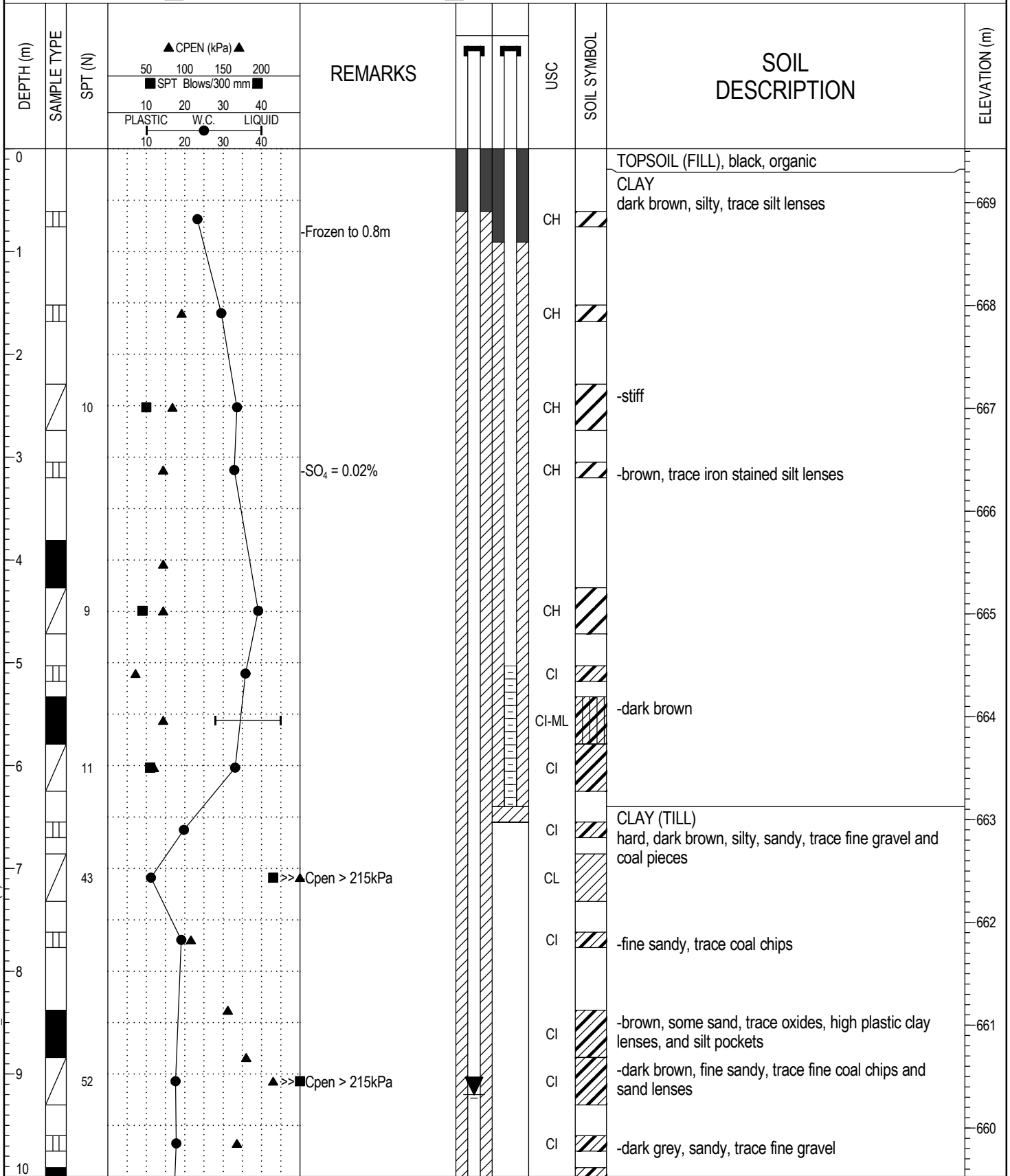

BOREHOLE LOG 30442-VW-GPJ_THRBR_AB-GDT_21-8-9_COPY (2) OF LIBRARY-NEW LOGO.GLB



FIELD LOGGED BY: TDC	COMPLETION DEPTH: 19.5 m
PREPARED BY: BR	COMPLETION DATE: 2021-03-30
REVIEWED BY: HER	

CLIENT: CIMA+	PROJECT: TERWILLEGAR DRIVE UPGRADING STAGE 2	BOREHOLE NO: TH21-15
DRILLING COMPANY: ALL SERVICE DRILLING INC	DATE DRILLED: March 30, 2021	PROJECT NO: 30442
DRILL/METHOD: D50 Track / Solid Stem Augers	LOCATION: N5927767.718, E28884.592	ELEVATION: 669.53 (m)

SAMPLE TYPE	<input type="checkbox"/> GRAB SAMPLE	<input checked="" type="checkbox"/> SPT	<input type="checkbox"/> SHELBY TUBE
BACKFILL TYPE	<input checked="" type="checkbox"/> BENTONITE	<input checked="" type="checkbox"/> DRILL CUTTINGS	<input type="checkbox"/> SAND

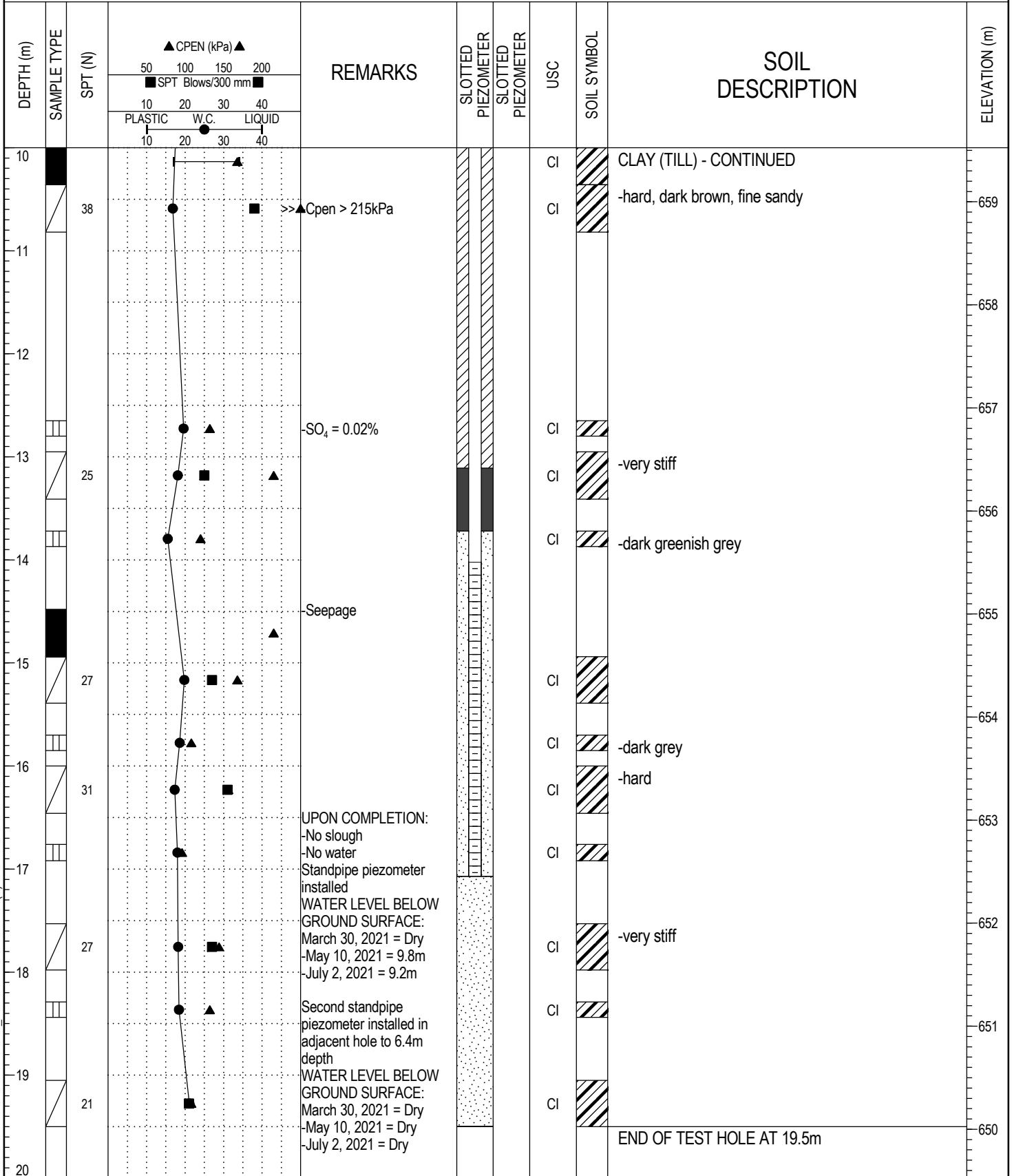

BOREHOLE LOG 30442-VW.GPJ_THRBR_AB.GDT_21-8-9- COPY (2) OF LIBRARY-NEW LOGO.GLB



FIELD LOGGED BY: TDC	COMPLETION DEPTH: 19.5 m
PREPARED BY: BR	COMPLETION DATE: 2021-03-30
REVIEWED BY: HER	

CLIENT: CIMA+	PROJECT: TERWILLEGAR DRIVE UPGRADING STAGE 2	BOREHOLE NO: TH21-21
DRILLING COMPANY: ALL SERVICE DRILLING INC	DATE DRILLED: April 10, 2021	PROJECT NO: 30442
DRILL/METHOD: CME55 Track / Solid Stem Augers	LOCATION: N5927727.067, E28520.502	ELEVATION: 674.26 (m)

SAMPLE TYPE	<input type="checkbox"/> GRAB SAMPLE	<input checked="" type="checkbox"/> SPT	<input type="checkbox"/> SHELBY TUBE	<input checked="" type="checkbox"/> NO RECOVERY
BACKFILL TYPE	<input checked="" type="checkbox"/> BENTONITE	<input checked="" type="checkbox"/> DRILL CUTTINGS	<input type="checkbox"/> SLOUGH	

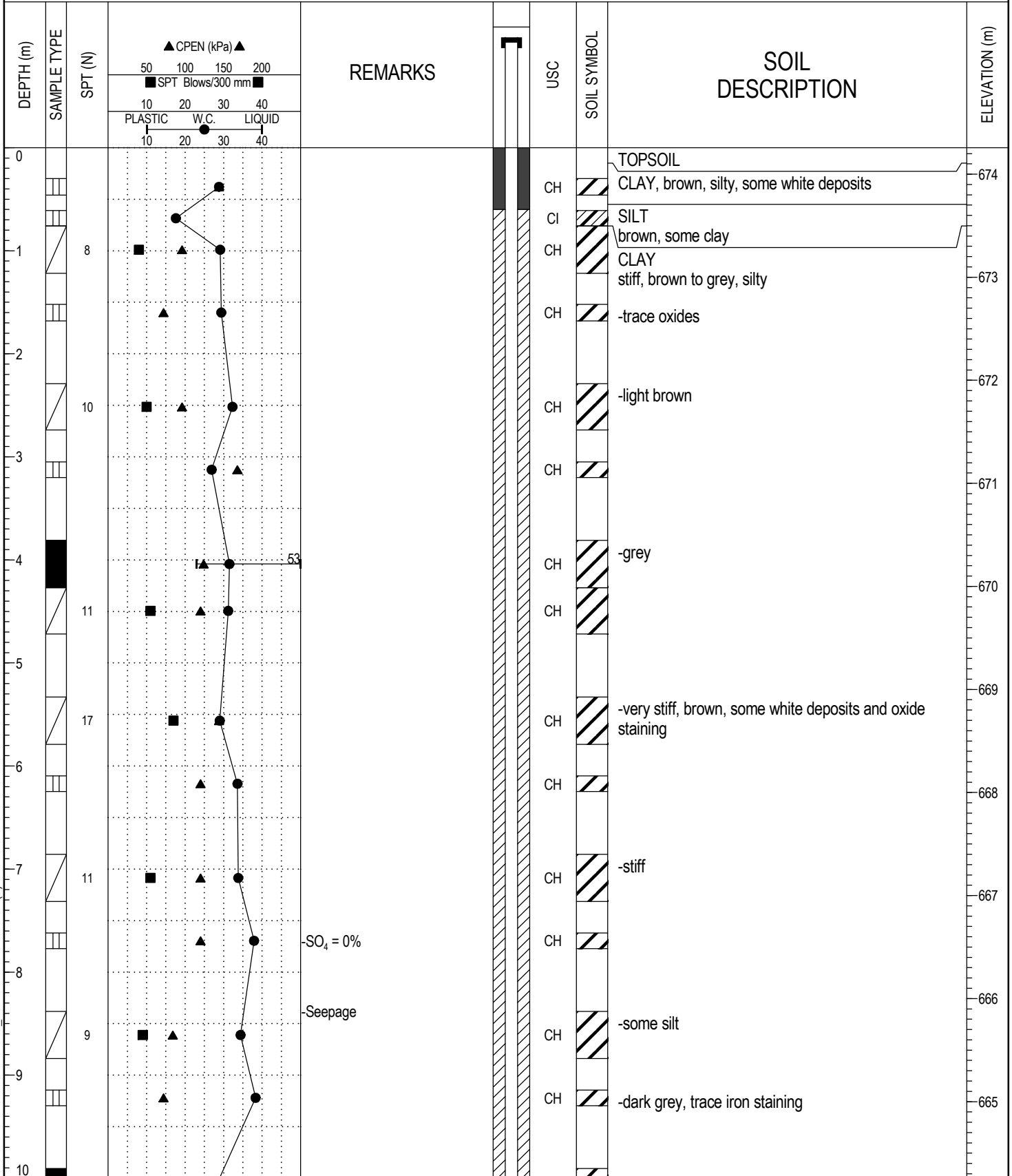

BOREHOLE LOG 30442-VW.GPJ_THRBR_AB.GDT_21-8-9_COPY (2) OF LIBRARY-NEW.LOG.GLB



FIELD LOGGED BY: GM	COMPLETION DEPTH: 30.2 m
PREPARED BY: BR	COMPLETION DATE: 2021-04-10
REVIEWED BY: HER	

CLIENT: CIMA+	PROJECT: TERWILLEGAR DRIVE UPGRADING STAGE 2	BOREHOLE NO: TH21-21
DRILLING COMPANY: ALL SERVICE DRILLING INC	DATE DRILLED: April 10, 2021	PROJECT NO: 30442
DRILL/METHOD: CME55 Track / Solid Stem Augers	LOCATION: N5927727.067, E28520.502	ELEVATION: 674.26 (m)

SAMPLE TYPE	<input type="checkbox"/> GRAB SAMPLE	<input type="checkbox"/> SPT	<input type="checkbox"/> SHELBY TUBE	<input type="checkbox"/> NO RECOVERY
BACKFILL TYPE	<input type="checkbox"/> BENTONITE	<input type="checkbox"/> DRILL CUTTINGS	<input type="checkbox"/> SLOUGH	

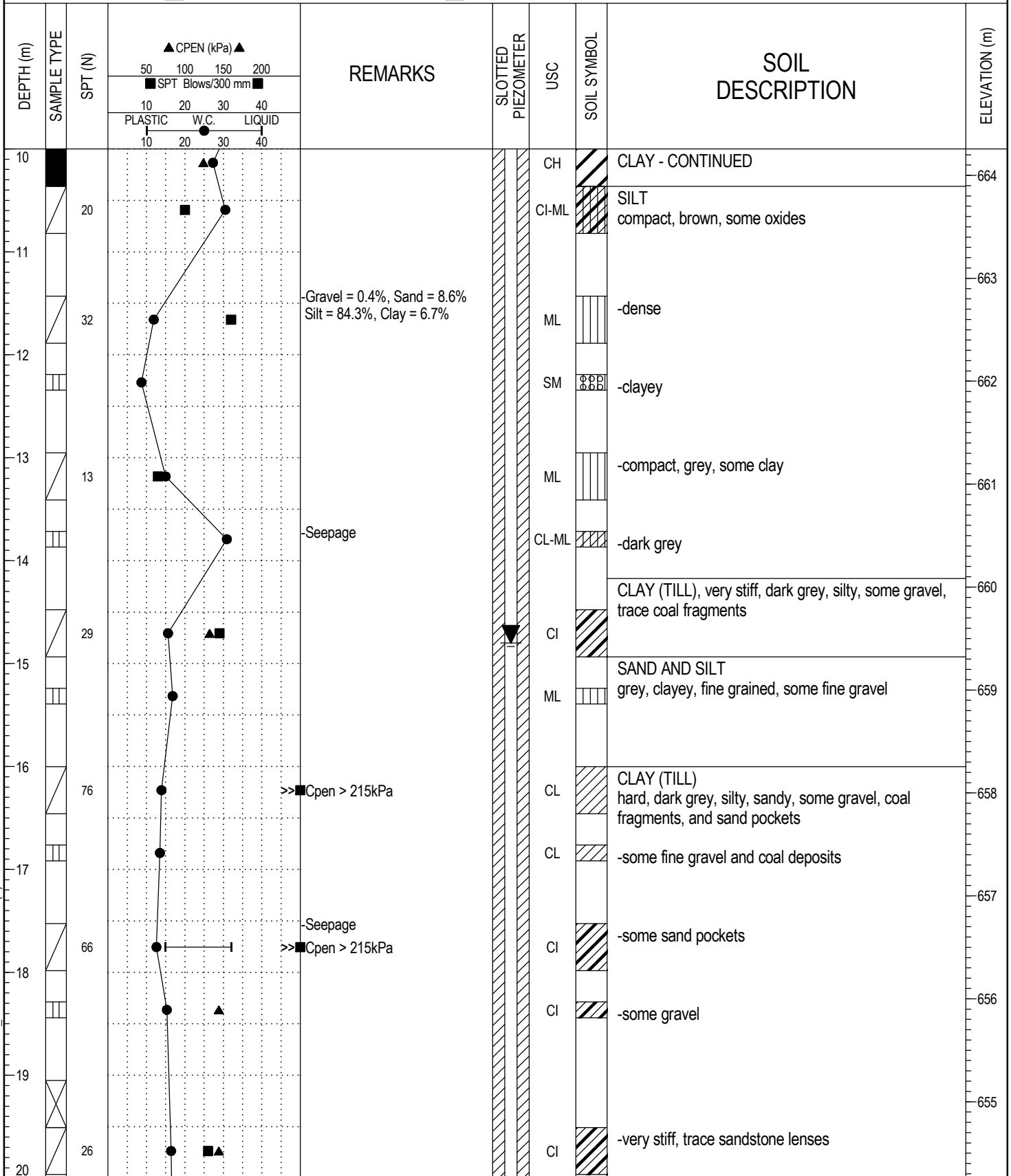

BOREHOLE LOG 30442-VW.GPJ_THRBR_AB.GDT_21-8-9_COPY (2) OF LIBRARY-NEW.LOG.GLB



FIELD LOGGED BY: GM	COMPLETION DEPTH: 30.2 m
PREPARED BY: BR	COMPLETION DATE: 2021-04-10
REVIEWED BY: HER	

CLIENT: CIMA+	PROJECT: TERWILLEGAR DRIVE UPGRADING STAGE 2	BOREHOLE NO: TH21-21
DRILLING COMPANY: ALL SERVICE DRILLING INC	DATE DRILLED: April 10, 2021	PROJECT NO: 30442
DRILL/METHOD: CME55 Track / Solid Stem Augers	LOCATION: N5927727.067, E28520.502	ELEVATION: 674.26 (m)

SAMPLE TYPE	<input type="checkbox"/> GRAB SAMPLE	<input checked="" type="checkbox"/> SPT	<input type="checkbox"/> SHELBY TUBE	<input checked="" type="checkbox"/> NO RECOVERY
BACKFILL TYPE	<input checked="" type="checkbox"/> BENTONITE	<input checked="" type="checkbox"/> DRILL CUTTINGS	<input type="checkbox"/> SLOUGH	

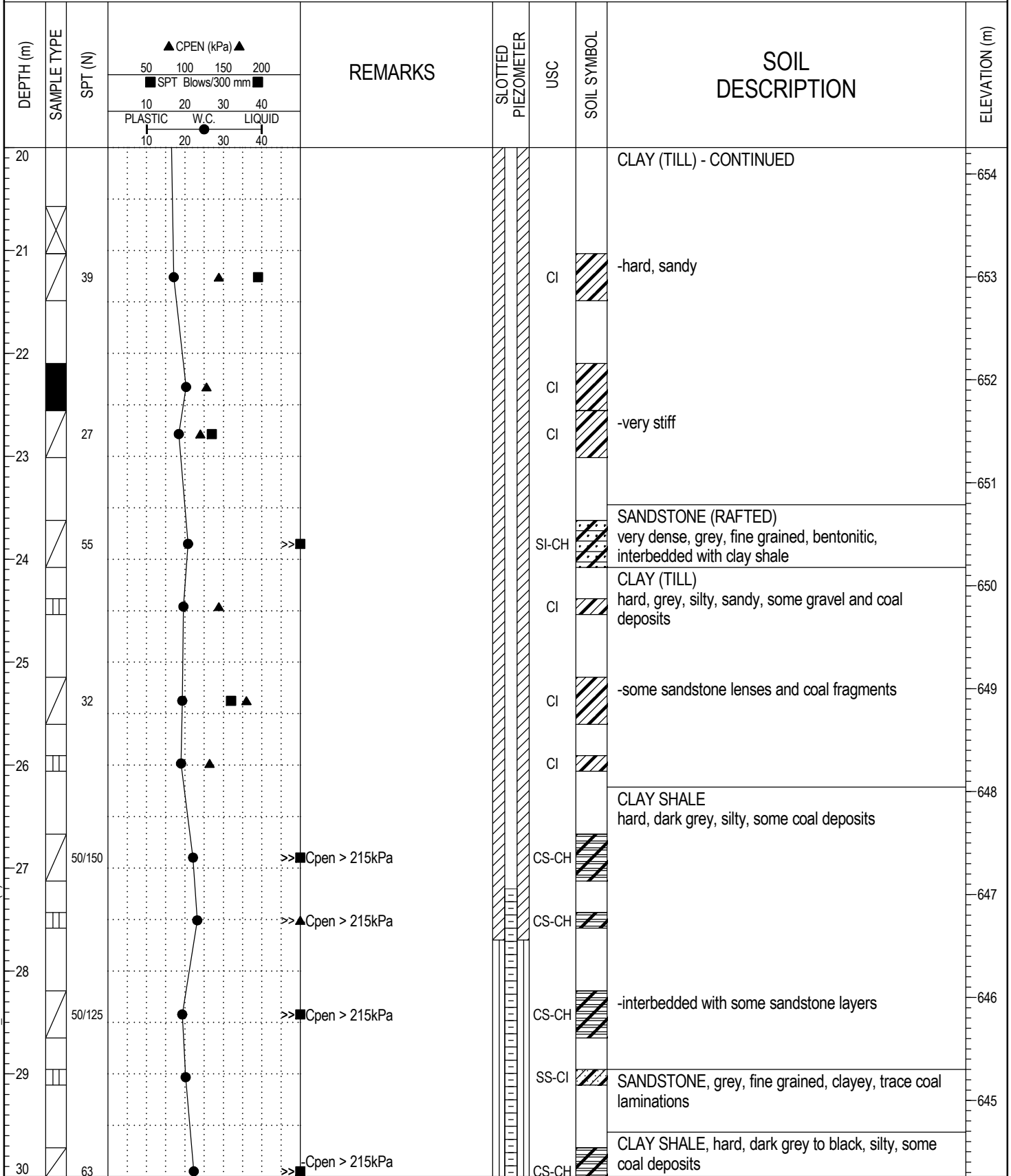

BOREHOLE LOG 30442-VW GPJ_THRBR_AB GDT_21-8-9_COPY (2) OF LIBRARY-NEW LOGO.GLB



FIELD LOGGED BY: GM	COMPLETION DEPTH: 30.2 m
PREPARED BY: BR	COMPLETION DATE: 2021-04-10
REVIEWED BY: HER	

CLIENT: CIMA+	PROJECT: TERWILLEGAR DRIVE UPGRADING STAGE 2	BOREHOLE NO: TH21-21		
DRILLING COMPANY: ALL SERVICE DRILLING INC	DATE DRILLED: April 10, 2021	PROJECT NO: 30442		
DRILL/METHOD: CME55 Track / Solid Stem Augers	LOCATION: N5927727.067, E28520.502	ELEVATION: 674.26 (m)		
SAMPLE TYPE	<input type="checkbox"/> GRAB SAMPLE	<input checked="" type="checkbox"/> SPT	<input type="checkbox"/> SHELBY TUBE	<input checked="" type="checkbox"/> NO RECOVERY
BACKFILL TYPE	<input checked="" type="checkbox"/> BENTONITE	<input checked="" type="checkbox"/> DRILL CUTTINGS	<input type="checkbox"/> SLOUGH	

DEPTH (m)	SAMPLE TYPE	SPT (N)	CPEN (kPa)				REMARKS	SLOTTED PIEZOMETER	USC	SOIL SYMBOL	SOIL DESCRIPTION	ELEVATION (m)
			50	100	150	200						
30										CLAY SHALE - CONTINUED	644	
31										END OF TEST HOLE AT 30.2m UPON COMPLETION: (Below ground surface) -Slough at 27.7m -Water at 25.3m Standpipe piezometer installed WATER LEVEL BELOW GROUND SURFACE: -April 10, 2021 = 23.9m -May 10, 2021 = 12.8m -July 2, 2021 = 14.8m	643	
32											642	
33											641	
34											640	
35											639	
36											638	
37											637	
38											636	
39											635	
40												

BOREHOLE LOG 30442-VW-GPJ_THRBR_AB.GDT_21-8-9_COPY (2) OF LIBRARY-NEW LOGO.GLB



FIELD LOGGED BY: GM	COMPLETION DEPTH: 30.2 m
PREPARED BY: BR	COMPLETION DATE: 2021-04-10
REVIEWED BY: HER	

PROJECT CITY OF EDMONTON - WHITEMUD DRIVE

TESTHOLE No. 22

SURFACE ELEVATION 244.5

JOB No. E 1060

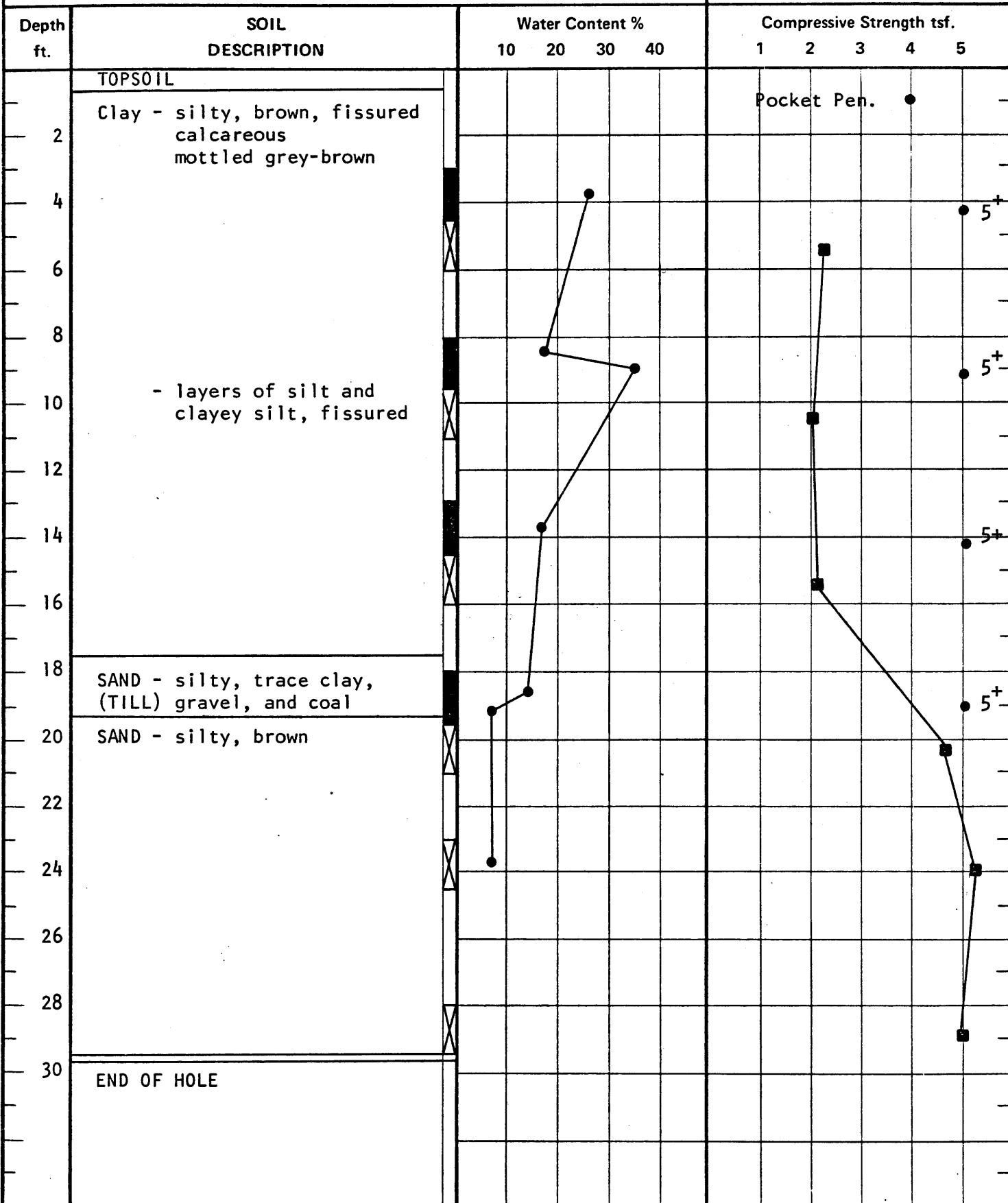

Completion Depth 29.5

Date 16/5/75

10 20 30 40 50
Blows/Ft.



Depth to Water in Boring Dry

Page 1 of 1

Penetration Resistance N

Dwg. No. 1060-A-3

PROJECT CITY OF EDMONTON _ WHITEMUD DRIVE TESTHOLE No. 23

SURFACE ELEVATION 242.5 JOB No. E 1060

Depth ft.	SOIL DESCRIPTION	Water Content %				Compressive Strength tsf.				
		10	20	30	40	1	2	3	4	5
2	TOPSOIL Clay - silty, brown, carbonaceous, slightly fissured.							●		
4	- mottled grey-brown		●							● ⁵⁺
6								■		
8	- layers of silt and clayey silt		●							● ⁵⁺
10								■		
12			●							● ⁵⁺
14								■		
16										
18	(TILL) sandy silt, some clay, trace of gravel, coal.		●							● ⁵⁺
20										N=60 for 5'
22	SAND - silty, brown, trace of coal									
24			●							N=73
26										
28										
30	END OF HOLE									
32										

Completion Depth 29.5

Date 16/5/75

10 20 30 40 50
Blow/Ft.



Depth to Water in Boring Dry

Page 1 of 1

Penetration Resistance N ■

Dwg. No. 1060- A-4

CLIENT: Al-Terra Engineering Ltd.	PROJECT: Terwillegar Drive and 40 Ave. / Buylea Rd.	BOREHOLE NO: TH19-01
DRILLING COMPANY: Mobile Augers & Research Ltd.	DATE DRILLED: March 14, 2019	PROJECT NO: 19715
DRILL/METHOD: #125 / Solid Stem Augers	LOCATION: N5928702, E329285	ELEVATION: 669.80 (m)

SAMPLE TYPE	<input type="checkbox"/> GRAB SAMPLE	<input checked="" type="checkbox"/> SPT
BACKFILL TYPE	<input checked="" type="checkbox"/> BENTONITE	<input type="checkbox"/> DRILL CUTTINGS <input type="checkbox"/> SLOUGH

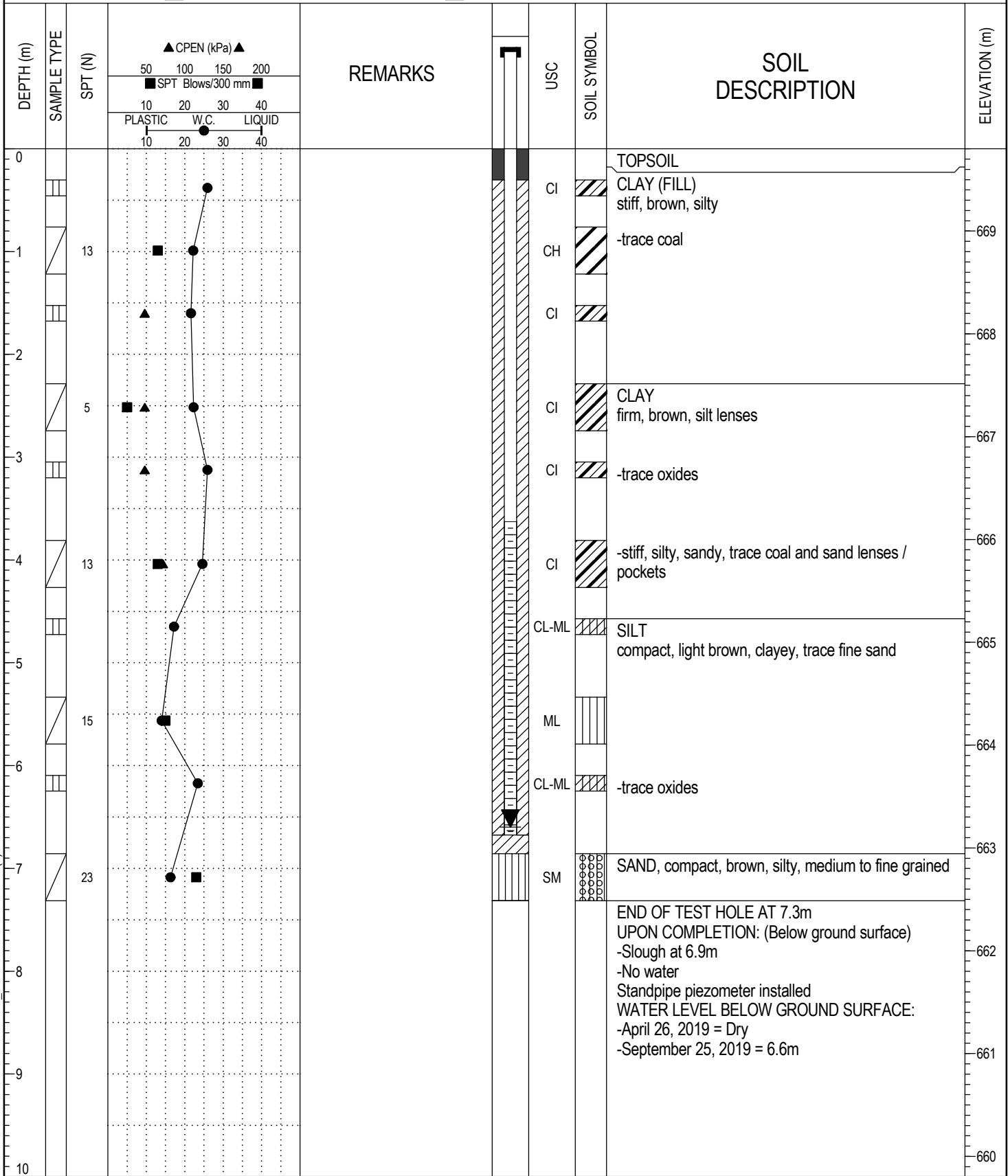

BOREHOLE LOG 19715-1-41-42.GPJ_THRBR_AB.GDT_21-7-19_COPY (2) OF LIBRARY-NEW LOGO.GLB



FIELD LOGGED BY: LRG / SK	COMPLETION DEPTH: 7.3 m
PREPARED BY: MG / SEC	COMPLETION DATE: 2019-03-14
REVIEWED BY: RWT	

CLIENT: Al-Terra Engineering Ltd.	PROJECT: Terwillegar Drive and 40 Ave. / Buylea Rd.	BOREHOLE NO: TH19-41
DRILLING COMPANY: Mobile Augers & Research Ltd.	DATE DRILLED: July 22, 2019	PROJECT NO: 19715
DRILL/METHOD: Track / Solid Stem Augers	LOCATION: N5928924, E329479	ELEVATION: 667.23 (m)

SAMPLE TYPE	<input type="checkbox"/> GRAB SAMPLE	<input checked="" type="checkbox"/> SPT	<input type="checkbox"/> SHELBY TUBE
BACKFILL TYPE	<input checked="" type="checkbox"/> BENTONITE	<input type="checkbox"/> DRILL CUTTINGS	<input type="checkbox"/> SLOUGH

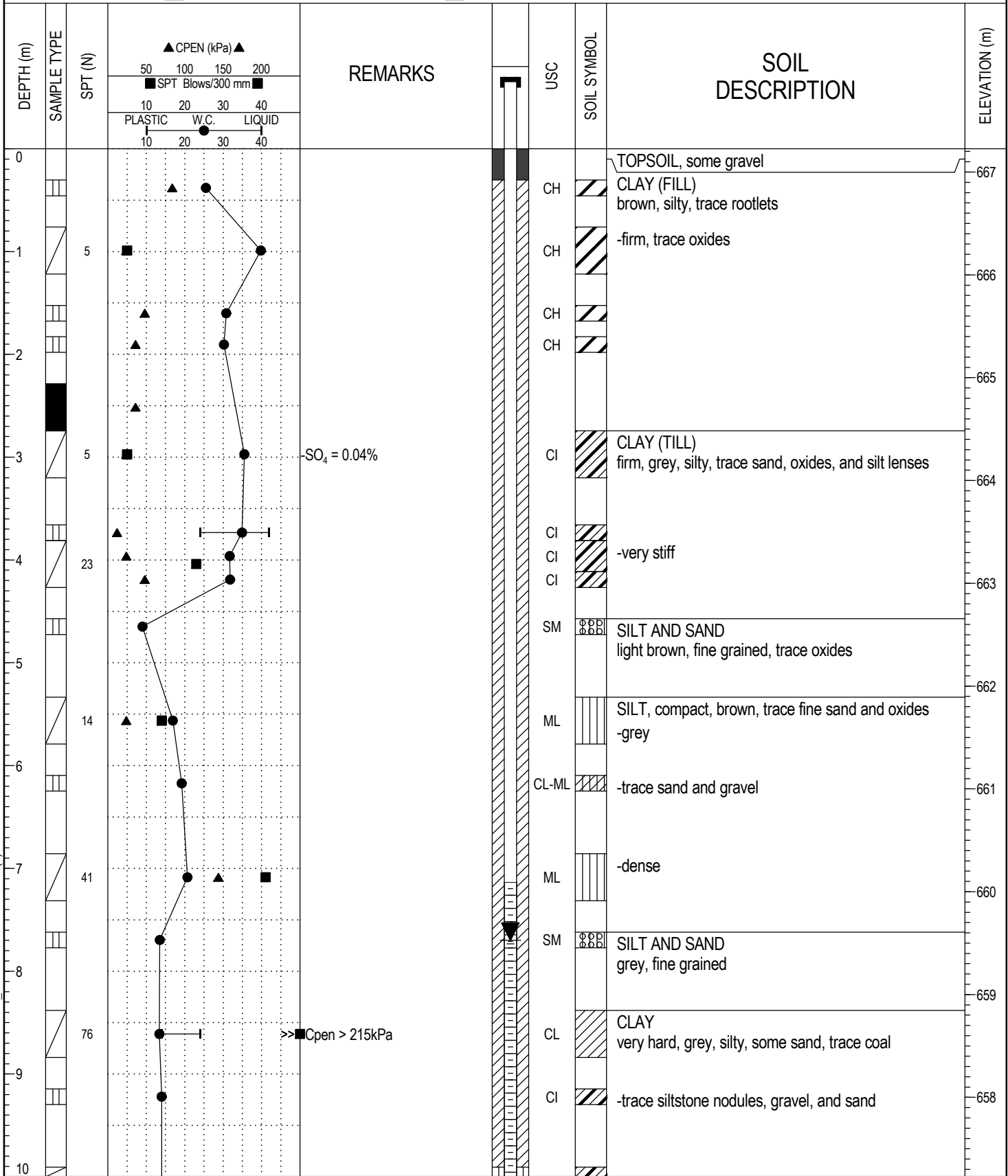

BOREHOLE LOG 19715-1.41.42.GPJ_THRBR_AB.GDT_21-7-19_COPY (2) OF LIBRARY-NEW.LOGO.GLB



FIELD LOGGED BY: JAG	COMPLETION DEPTH: 10.4 m
PREPARED BY: MG / SEC	COMPLETION DATE: 2019-07-22
REVIEWED BY: RWT	

CLIENT: Al-Terra Engineering Ltd.	PROJECT: Terwillegar Drive and 40 Ave. / Buylea Rd.	BOREHOLE NO: TH19-41	
DRILLING COMPANY: Mobile Augers & Research Ltd.	DATE DRILLED: July 22, 2019	PROJECT NO: 19715	
DRILL/METHOD: Track / Solid Stem Augers	LOCATION: N5928924, E329479	ELEVATION: 667.23 (m)	
SAMPLE TYPE	<input type="checkbox"/> GRAB SAMPLE	<input checked="" type="checkbox"/> SPT	<input type="checkbox"/> SHELBY TUBE
BACKFILL TYPE	<input type="checkbox"/> BENTONITE	<input checked="" type="checkbox"/> DRILL CUTTINGS	<input type="checkbox"/> SLOUGH

DEPTH (m)	SAMPLE TYPE	SPT (N)	REMARKS			SLOTTED PIEZOMETER	USC	SOIL SYMBOL	SOIL DESCRIPTION	ELEVATION (m)
			▲ CPEN (kPa) ▲	■ SPT Blows/300 mm ■	PLASTIC W.C. LIQUID					
10		69/229	<p>▲ CPEN (kPa) ▲</p> <p>50 100 150 200</p> <p>■ SPT Blows/300 mm ■</p> <p>10 20 30 40</p> <p>PLASTIC W.C. LIQUID</p> <p>10 20 30 40</p>	>>■ Cpen > 215kPa			CI	<p>CLAY - CONTINUED</p> <p>-trace sand lenses</p> <p>END OF TEST HOLE AT 10.4m</p> <p>UPON COMPLETION: (Below ground surface)</p> <p>-Slough at 9.9m</p> <p>-Water at 9.6m</p> <p>Standpipe piezometer installed</p> <p>WATER LEVEL BELOW GROUND SURFACE:</p> <p>-July 22, 2019 = 9.1m</p> <p>-September 25, 2019 = 7.7m</p>	657	
11									656	
12									655	
13									654	
14									653	
15									652	
16									651	
17									650	
18									649	
19									648	
20										

BOREHOLE LOG 19715 - 1.41.42.GPJ_THRBR_AB.GDT_21-7-19_COPY (2) OF LIBRARY-NEW LOGO.GLB



FIELD LOGGED BY: JAG	COMPLETION DEPTH: 10.4 m
PREPARED BY: MG / SEC	COMPLETION DATE: 2019-07-22
REVIEWED BY: RWT	

CLIENT: Al-Terra Engineering Ltd.	PROJECT: Terwillegar Drive and 40 Ave. / Buylea Rd.	BOREHOLE NO: TH19-42
DRILLING COMPANY: Mobile Augers & Research Ltd.	DATE DRILLED: July 22, 2019	PROJECT NO: 19715
DRILL/METHOD: Track / Solid Stem Augers	LOCATION: N5928669, E329339	ELEVATION: 672.60 (m)

SAMPLE TYPE GRAB SAMPLE SPT SHELBY TUBE

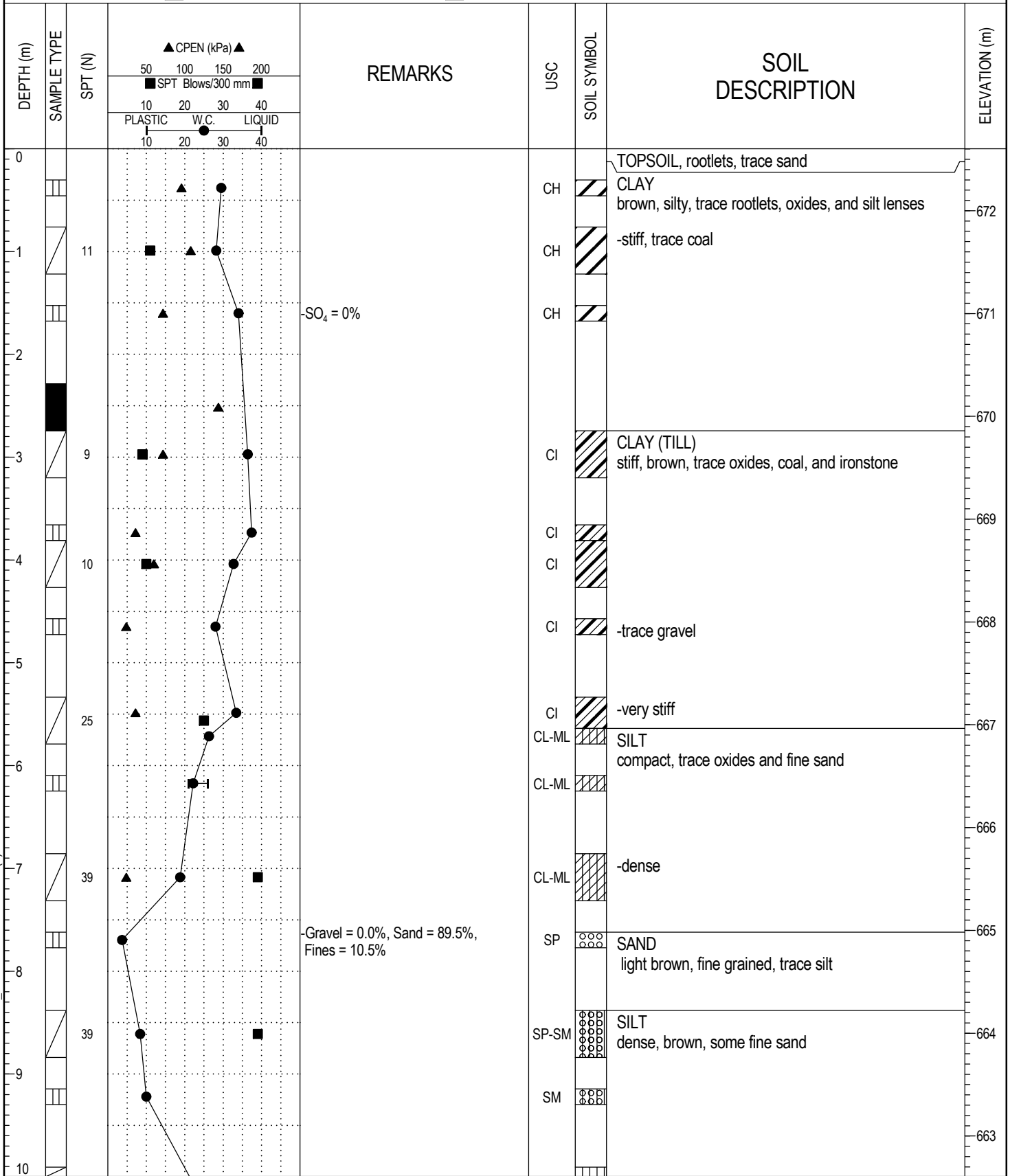

BOREHOLE LOG 19715-1.41.42.GPJ_THRBR_AB.GDT_21-7-19_COPY (2) OF LIBRARY-NEW.LOGO.GLB



FIELD LOGGED BY: JAG	COMPLETION DEPTH: 10.4 m
PREPARED BY: MG / SEC	COMPLETION DATE: 2019-07-22
REVIEWED BY: RWT	

CLIENT: Al-Terra Engineering Ltd.	PROJECT: Terwillegar Drive and 40 Ave. / Buylea Rd.	BOREHOLE NO: TH19-42
DRILLING COMPANY: Mobile Augers & Research Ltd.	DATE DRILLED: July 22, 2019	PROJECT NO: 19715
DRILL/METHOD: Track / Solid Stem Augers	LOCATION: N5928669, E329339	ELEVATION: 672.60 (m)
SAMPLE TYPE <input type="checkbox"/> GRAB SAMPLE <input checked="" type="checkbox"/> SPT <input type="checkbox"/> SHELBY TUBE		

DEPTH (m)	SAMPLE TYPE	SPT (N)	CPEN (kPa)		REMARKS	USC	SOIL SYMBOL	SOIL DESCRIPTION	ELEVATION (m)
			50	100					
10		25				ML	SILT - CONTINUED -compact, trace sand END OF TEST HOLE AT 10.4m UPON COMPLETION: (Below ground surface) -Slough at 9.9m -No water Backfilled with drill cuttings and bentonite chips at surface	662	
11								661	
12								660	
13								659	
14								658	
15								657	
16								656	
17								655	
18								654	
19								653	
20								653	

BOREHOLE LOG 19715-1.41.42.GPJ_THRBR_AB.GDT_21-7-19_COPY (2) OF LIBRARY-NEW LOGO.GLB



FIELD LOGGED BY: JAG	COMPLETION DEPTH: 10.4 m
PREPARED BY: MG / SEC	COMPLETION DATE: 2019-07-22
REVIEWED BY: RWT	Page 2 of 2

CLIENT: DIALOG	PROJECT: 142 Street Pedestrian / Cyclist Bridge	BOREHOLE NO: TH21-2
DRILLING COMPANY: All Service Drilling Inc.	DATE DRILLED: July 17, 2021	PROJECT NO: 29123
DRILL/METHOD: CME 45B / Solid Stem Augers	LOCATION: N5929010, E329743	ELEVATION: 663.01 (m)
SAMPLE TYPE <input type="checkbox"/> GRAB SAMPLE <input checked="" type="checkbox"/> SPT <input checked="" type="checkbox"/> NO RECOVERY		

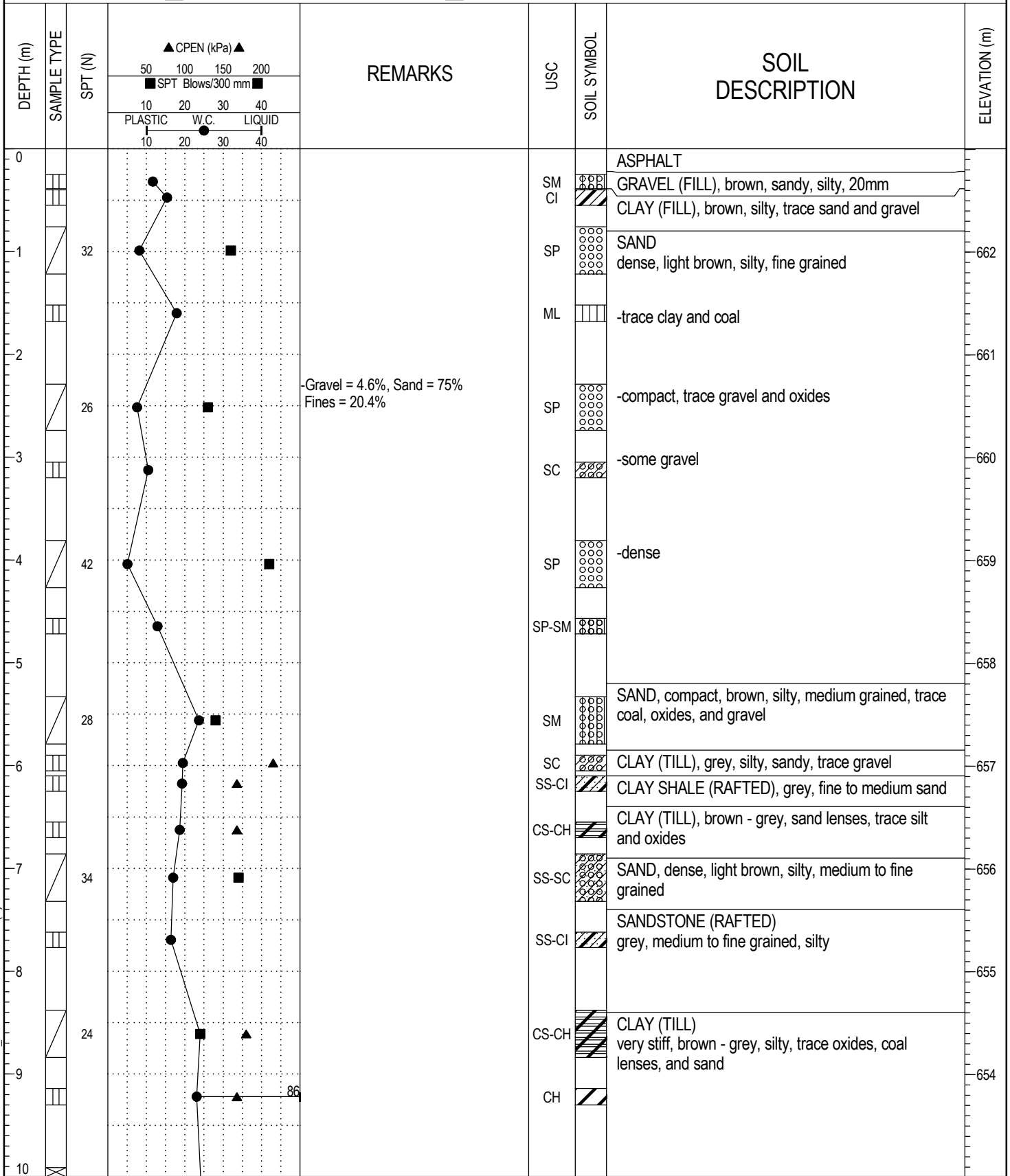

BOREHOLE LOG 29123.GPJ_THRBR_AB.GDT_21-8-9_COPY (2) OF LIBRARY-NEW LOGO.GLB



FIELD LOGGED BY: BP	COMPLETION DEPTH: 24.1 m
PREPARED BY: MG	COMPLETION DATE: 2021-07-17
REVIEWED BY:	

CLIENT: DIALOG	PROJECT: 142 Street Pedestrian / Cyclist Bridge	BOREHOLE NO: TH21-2
DRILLING COMPANY: All Service Drilling Inc.	DATE DRILLED: July 17, 2021	PROJECT NO: 29123
DRILL/METHOD: CME 45B / Solid Stem Augers	LOCATION: N5929010, E329743	ELEVATION: 663.01 (m)
SAMPLE TYPE <input type="checkbox"/> GRAB SAMPLE <input checked="" type="checkbox"/> SPT <input checked="" type="checkbox"/> NO RECOVERY		

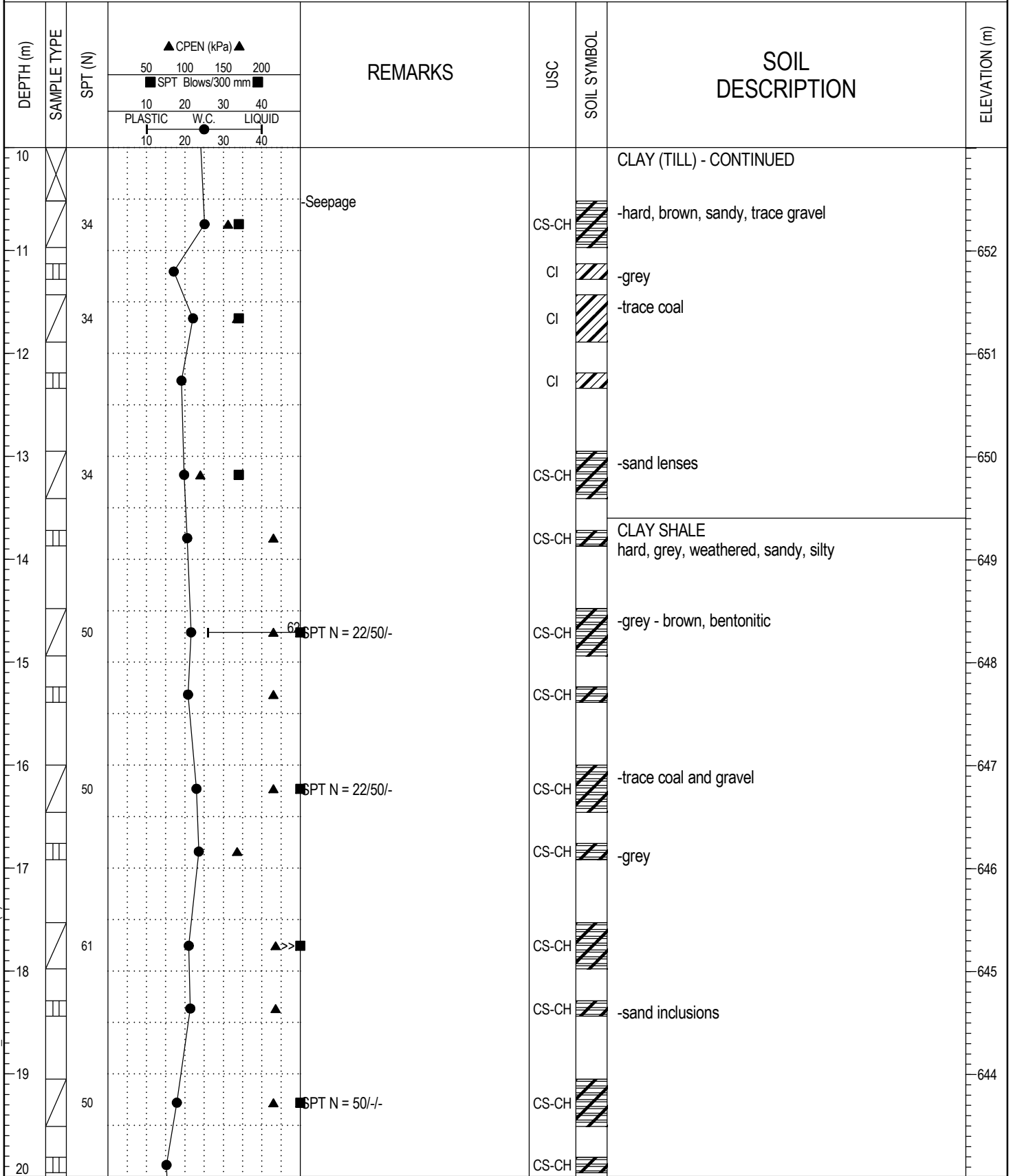

BOREHOLE LOG 29123.GPJ THRBRR_AB.GDT 21-8-9 - COPY (2) OF LIBRARY-NEW LOGO.GLB



FIELD LOGGED BY: BP	COMPLETION DEPTH: 24.1 m
PREPARED BY: MG	COMPLETION DATE: 2021-07-17
REVIEWED BY:	

CLIENT: DIALOG	PROJECT: 142 Street Pedestrian / Cyclist Bridge	BOREHOLE NO: TH21-2
DRILLING COMPANY: All Service Drilling Inc.	DATE DRILLED: July 17, 2021	PROJECT NO: 29123
DRILL/METHOD: CME 45B / Solid Stem Augers	LOCATION: N5929010, E329743	ELEVATION: 663.01 (m)
SAMPLE TYPE <input type="checkbox"/> GRAB SAMPLE <input checked="" type="checkbox"/> SPT <input checked="" type="checkbox"/> NO RECOVERY		

DEPTH (m)	SAMPLE TYPE	SPT (N)	REMARKS	USC	SOIL SYMBOL	SOIL DESCRIPTION	ELEVATION (m)
20						CLAY SHALE - CONTINUED	
21		50	SPT N = 24/50/-	SS-CI			642
22		50	SPT N = 50/-/-	CS-CH			641
23		50	SPT N = 50/-/-	CS-CH			640
24		50	SPT N = 50/-/-	CS-CH			639
25						AUGER REFUSAL AT 24.1m UPON COMPLETION: Backfilled with drill cuttings, bentonite chips, and cold mix at surface	638
26							637
27							636
28							635
29							634
30							

BOREHOLE LOG 29123.GPJ_THRBR_AB.GDT_21-8-9 - COPY (2) OF LIBRARY-NEW LOGO.GLB



FIELD LOGGED BY: BP	COMPLETION DEPTH: 24.1 m
PREPARED BY: MG	COMPLETION DATE: 2021-07-17
REVIEWED BY:	

CLIENT: DIALOG	PROJECT: 142 Street Pedestrian / Cyclist Bridge	BOREHOLE NO: TH21-3
DRILLING COMPANY: All Service Drilling Inc.	DATE DRILLED: July 10, 2021	PROJECT NO: 29123
DRILL/METHOD: D50 / Solid Stem Augers	LOCATION: N5928955, E329744	ELEVATION: 672.54 (m)
SAMPLE TYPE	<input type="checkbox"/> GRAB SAMPLE <input checked="" type="checkbox"/> SPT <input checked="" type="checkbox"/> SHELBY TUBE	
BACKFILL TYPE	<input checked="" type="checkbox"/> BENTONITE <input checked="" type="checkbox"/> DRILL CUTTINGS <input type="checkbox"/> SLOUGH	

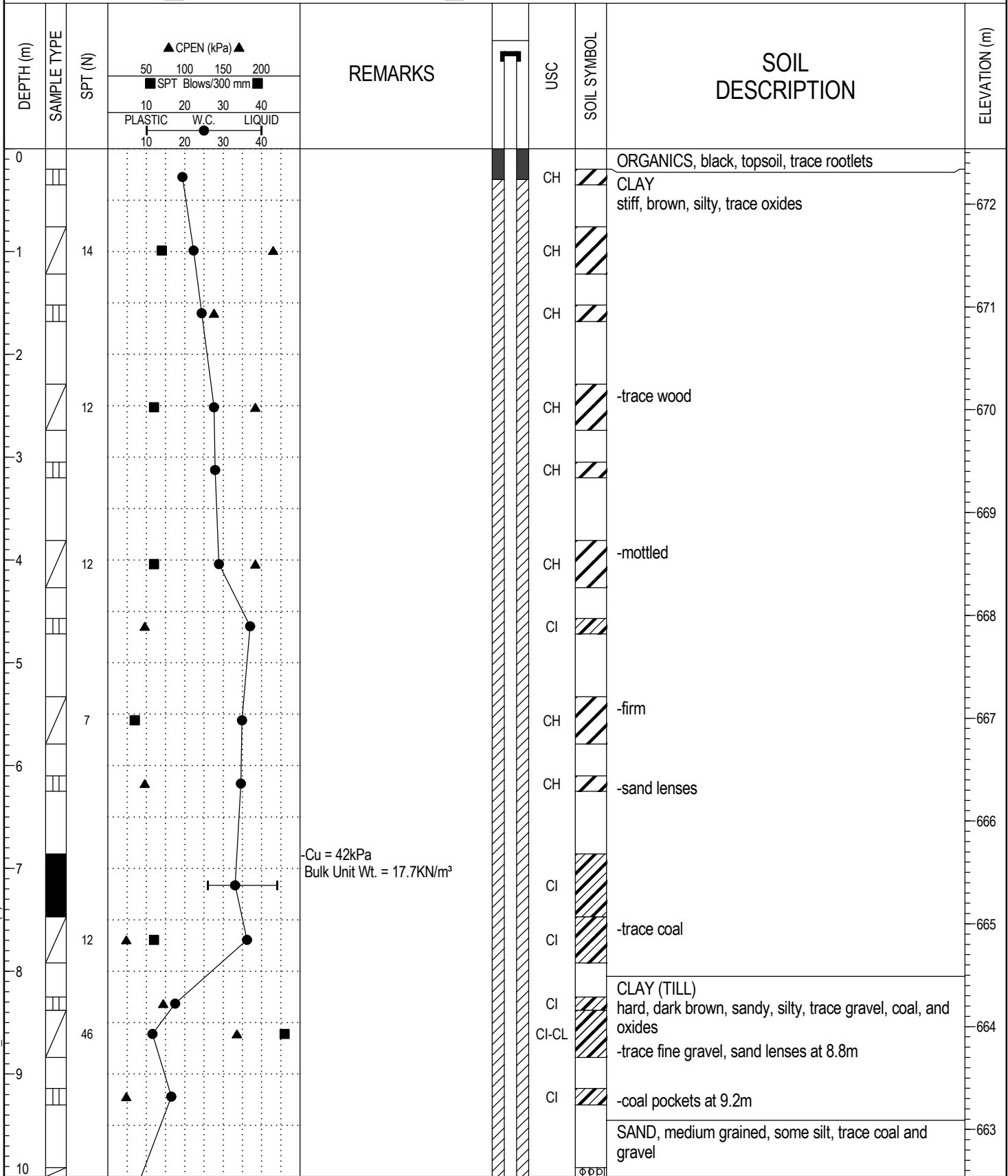

BOREHOLE LOG 29123.GPJ THRBRR_AB.GDT 21-8-9 - COPY (2) OF LIBRARY-NEW LOGO.GLB



FIELD LOGGED BY: BP	COMPLETION DEPTH: 30.2 m
PREPARED BY: MG	COMPLETION DATE: 2021-07-10
REVIEWED BY:	

CLIENT: DIALOG	PROJECT: 142 Street Pedestrian / Cyclist Bridge	BOREHOLE NO: TH21-3
DRILLING COMPANY: All Service Drilling Inc.	DATE DRILLED: July 10, 2021	PROJECT NO: 29123
DRILL/METHOD: D50 / Solid Stem Augers	LOCATION: N5928955, E329744	ELEVATION: 672.54 (m)

SAMPLE TYPE	<input type="checkbox"/> GRAB SAMPLE	<input checked="" type="checkbox"/> SPT	<input type="checkbox"/> SHELBY TUBE
BACKFILL TYPE	<input checked="" type="checkbox"/> BENTONITE	<input checked="" type="checkbox"/> DRILL CUTTINGS	<input type="checkbox"/> SLOUGH

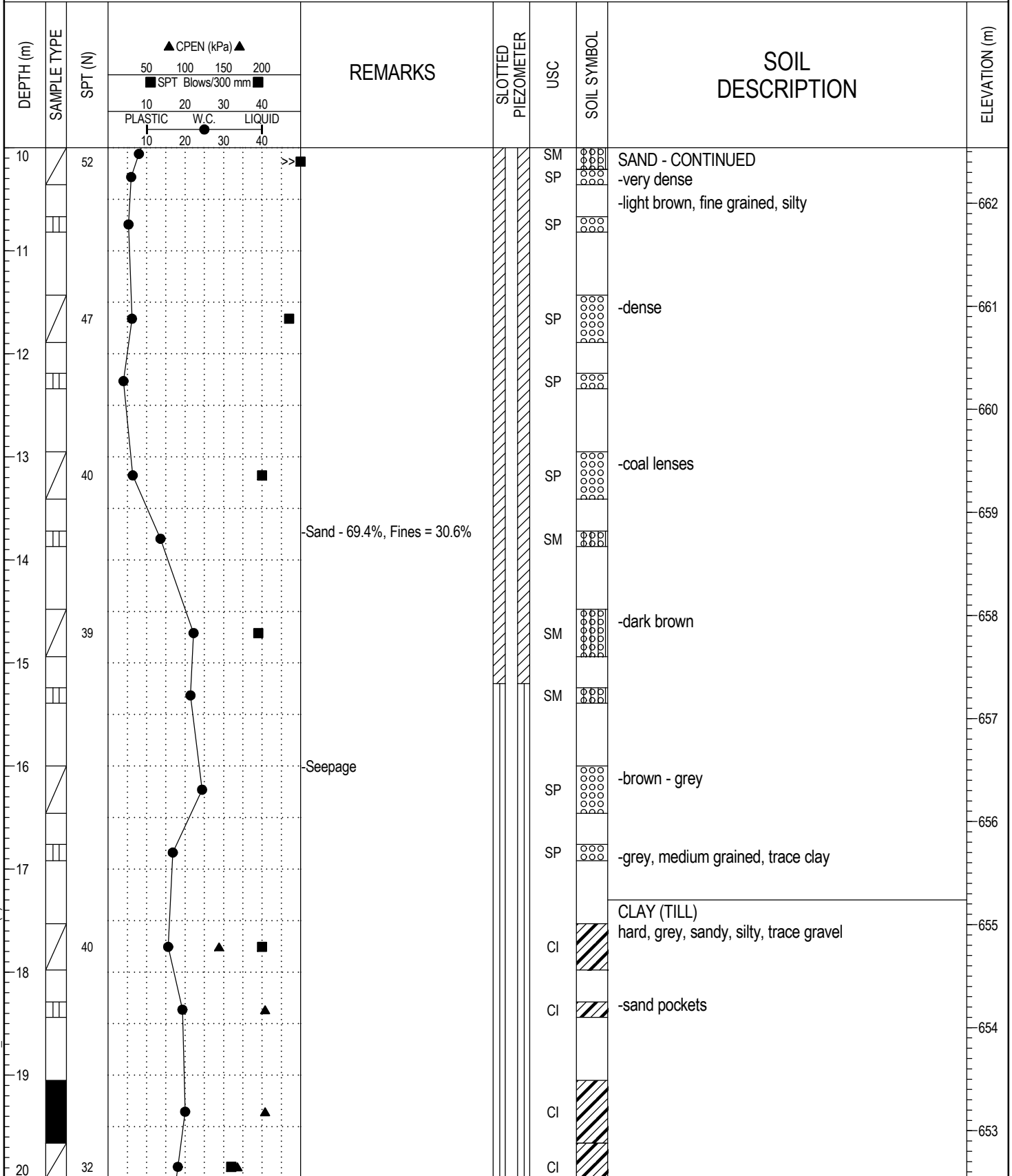

BOREHOLE LOG 29123.GPJ_THRBRR_AB.GDT_21-8-9_COPY (2) OF LIBRARY-NEW LOGO.GLB



FIELD LOGGED BY: BP	COMPLETION DEPTH: 30.2 m
PREPARED BY: MG	COMPLETION DATE: 2021-07-10
REVIEWED BY:	

CLIENT: DIALOG	PROJECT: 142 Street Pedestrian / Cyclist Bridge	BOREHOLE NO: TH21-3
DRILLING COMPANY: All Service Drilling Inc.	DATE DRILLED: July 10, 2021	PROJECT NO: 29123
DRILL/METHOD: D50 / Solid Stem Augers	LOCATION: N5928955, E329744	ELEVATION: 672.54 (m)

SAMPLE TYPE	<input type="checkbox"/> GRAB SAMPLE	<input checked="" type="checkbox"/> SPT	<input checked="" type="checkbox"/> SHELBY TUBE
BACKFILL TYPE	<input checked="" type="checkbox"/> BENTONITE	<input checked="" type="checkbox"/> DRILL CUTTINGS	<input type="checkbox"/> SLOUGH

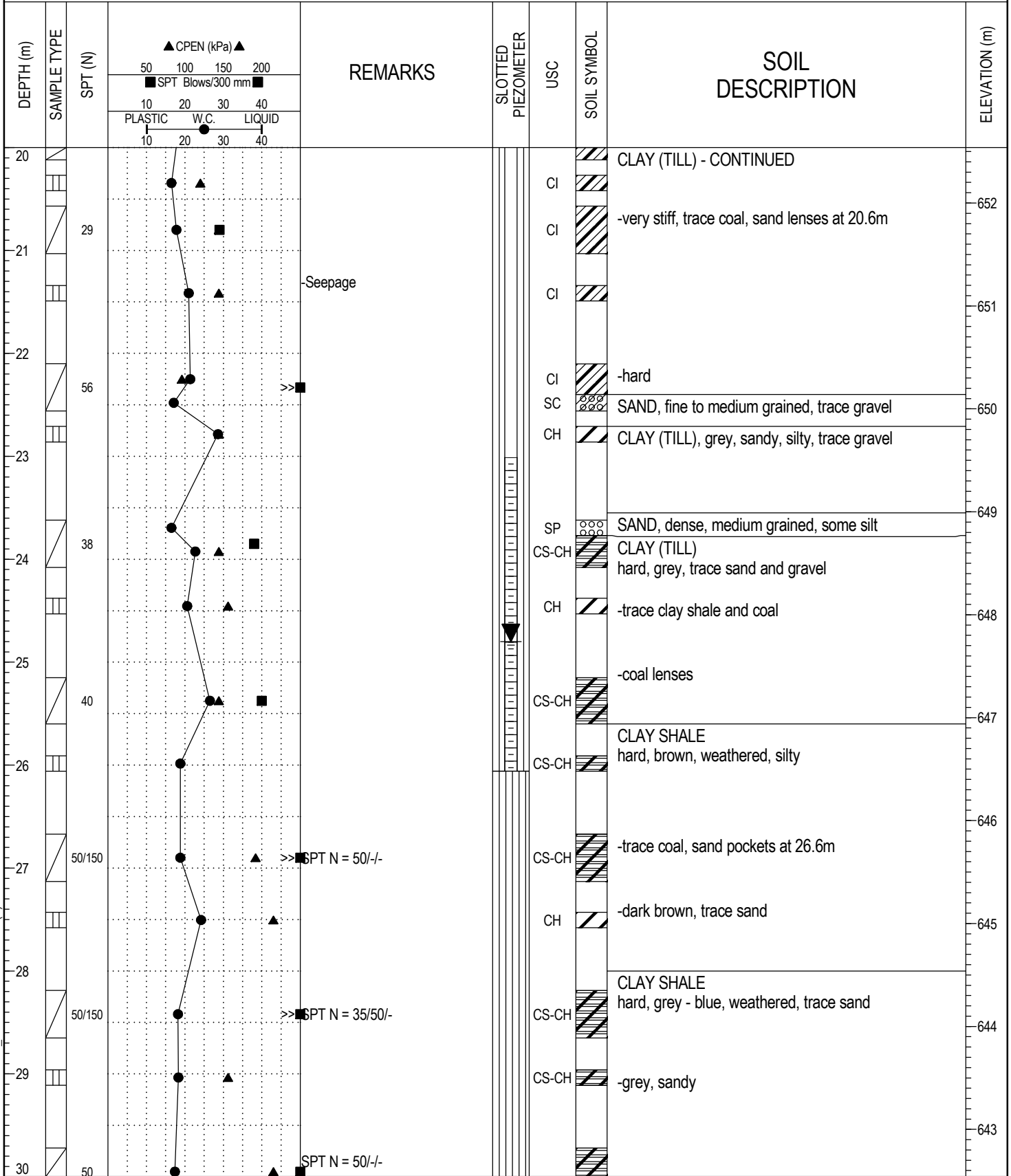

BOREHOLE LOG 29123.GPJ_THRBRR_AB.GDT_21-8-9_COPY (2) OF LIBRARY-NEW LOGO.GLB



FIELD LOGGED BY: BP	COMPLETION DEPTH: 30.2 m
PREPARED BY: MG	COMPLETION DATE: 2021-07-10
REVIEWED BY:	

CLIENT: DIALOG	PROJECT: 142 Street Pedestrian / Cyclist Bridge	BOREHOLE NO: TH21-3	
DRILLING COMPANY: All Service Drilling Inc.	DATE DRILLED: July 10, 2021	PROJECT NO: 29123	
DRILL/METHOD: D50 / Solid Stem Augers	LOCATION: N5928955, E329744	ELEVATION: 672.54 (m)	
SAMPLE TYPE	<input type="checkbox"/> GRAB SAMPLE	<input checked="" type="checkbox"/> SPT	<input type="checkbox"/> SHELBY TUBE
BACKFILL TYPE	<input type="checkbox"/> BENTONITE	<input checked="" type="checkbox"/> DRILL CUTTINGS	<input type="checkbox"/> SLOUGH

DEPTH (m)	SAMPLE TYPE	SPT (N)	CPEN (kPa) ▲				REMARKS	SLOTTED PIEZOMETER	USC	SOIL SYMBOL	SOIL DESCRIPTION	ELEVATION (m)
			50	100	150	200						
			■ SPT Blows/300 mm ■									
			10	20	30	40						
			PLASTIC		W.C.	LIQUID						
			10	20	30	40						
30									CS-CH	CLAY SHALE - CONTINUED		
										END OF TEST HOLE AT 30.2m UPON COMPLETION: (Below ground surface) -Slough at 15.2m -Water at 25.8m Standpipe piezometer installed WATER LEVEL BELOW GROUND SURFACE: -July 10, 2021 = 24.8m	642	
31											641	
32											640	
33											639	
34											638	
35											637	
36											636	
37											635	
38											634	
39											633	
40											633	

BOREHOLE LOG 29123.GPJ_THRBRR_AB.GDT_21-8-9 - COPY (2) OF LIBRARY-NEW LOGO.GLB



FIELD LOGGED BY: BP	COMPLETION DEPTH: 30.2 m
PREPARED BY: MG	COMPLETION DATE: 2021-07-10
REVIEWED BY:	Page 4 of 4

DRAFT

APPENDIX C

Laboratory Test Results



ATTERBERG LIMITS
ASTM D4318

Client: CIMA+ Canada Inc
Project: Terwillegar Drive Stage 2
Project No: 30442
Test Hole: TH21-15
Sample No: ST8
Depth: 5.33 - 5.79 m

Date Tested: 12-Apr-21
Tested By: JAP
Checked By:

LIQUID LIMIT

Trial No:	1	2	3	4
No of Blows:	31	24	19	9
Container No.	1	2	3	4
Wet Soil + Container	18.91	17.36	15.74	18.25
Dry Soil + Container	13.1	11.94	10.76	12.22
Wt. Of Container	0	0	0	0
Moisture Content	44.4	45.4	46.3	49.3

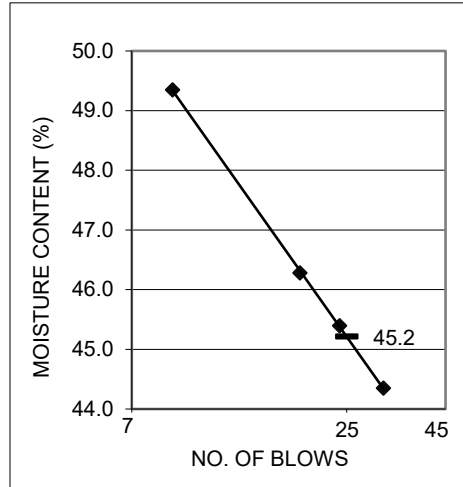

PLASTIC LIMIT

	1	2	AVERAGE
Container No.	5	6	
Wet Soil + Container	28.92	28.89	
Dry Soil + Container	26.76	26.70	
Wt. Of Container	18.92	18.76	
Moisture Content	27.6	27.6	27.6

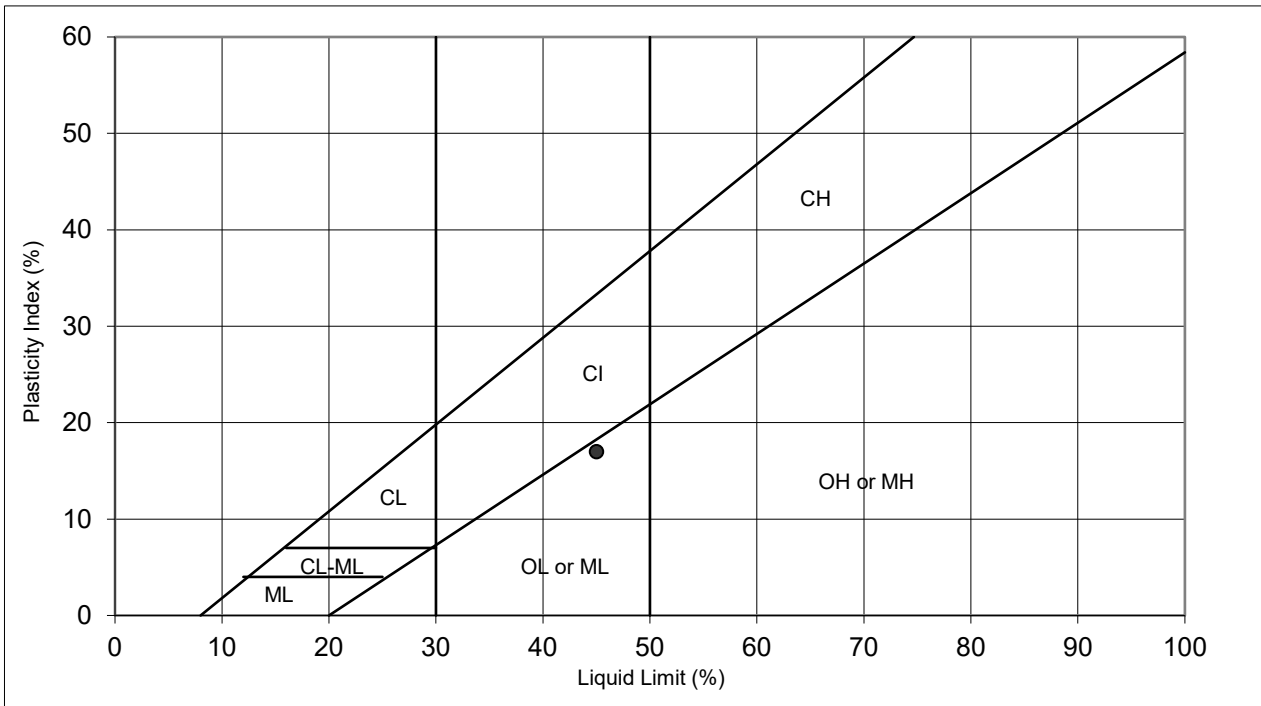

REMARKS

Liquid Limit:	45
Plastic Limit:	28
Plasticity Index:	17
USC Classification:	ML



ATTERBERG LIMITS
ASTM D4318

Client: CIMA+ Canada Inc
Project: Terwillegar Drive Stage 2
Project No: 30442
Test Hole: TH21-15
Sample No: ST16
Depth: 9.91 - 10.36 m

Date Tested: 12-Apr-21
Tested By: JAP
Checked By:

LIQUID LIMIT

Trial No:	1	2	3	4
No of Blows:	28	22	17	11
Container No.	1	2	3	4
Wet Soil + Container	15.76	18.04	16.5	18.08
Dry Soil + Container	11.85	13.45	12.2	13.15
Wt. Of Container	0	0	0	0
Moisture Content	33.0	34.1	35.2	37.5

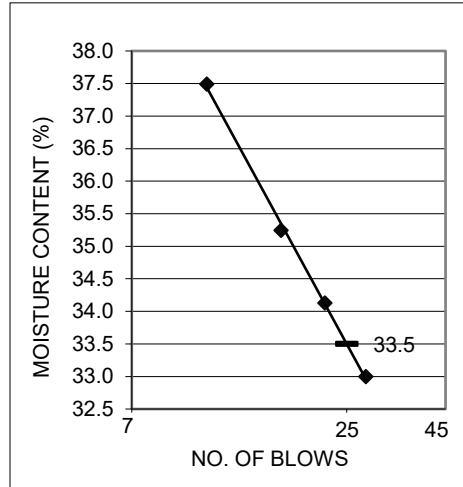

PLASTIC LIMIT

	1	2	AVERAGE
Container No.	5	6	
Wet Soil + Container	28.98	31.02	
Dry Soil + Container	27.52	29.29	
Wt. Of Container	18.7	18.82	
Moisture Content	16.6	16.5	16.5

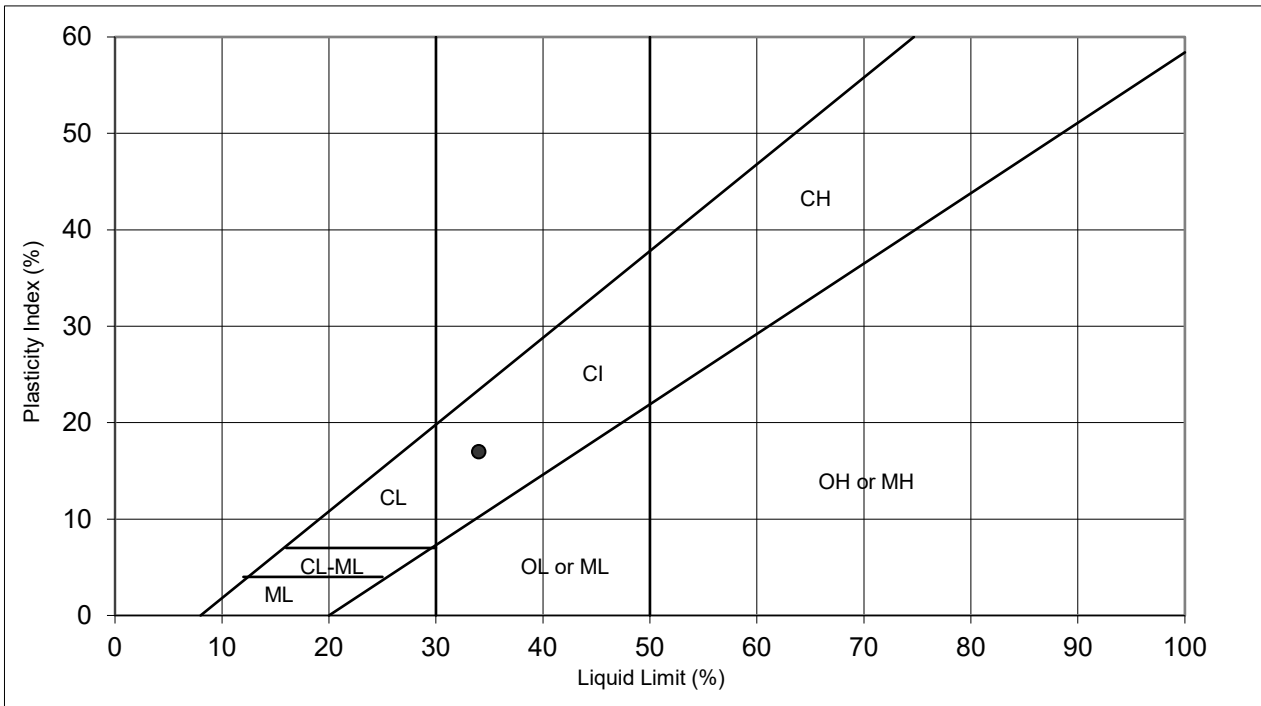

REMARKS

Liquid Limit:	34
Plastic Limit:	17
Plasticity Index:	17
USC Classification:	CI



ATTERBERG LIMITS
ASTM D4318

Client: CIMA+
Project: Terwillegar Drive Stage Two
Project No: 30442
Test Hole: TH21-21
Sample No: Sa. 7
Depth: 3.81 - 4.27 m

Date Tested: 04-May-21
Tested By: LLK
Checked By:

LIQUID LIMIT

Trial No:	1	2	3	4
No of Blows:	43	25	18	12
Container No.	1	2	3	4
Wet Soil + Container	20.35	17.28	21.93	17.43
Dry Soil + Container	13.49	11.31	14.25	11.2
Wt. Of Container	0	0	0	0
Moisture Content	50.9	52.8	53.9	55.6

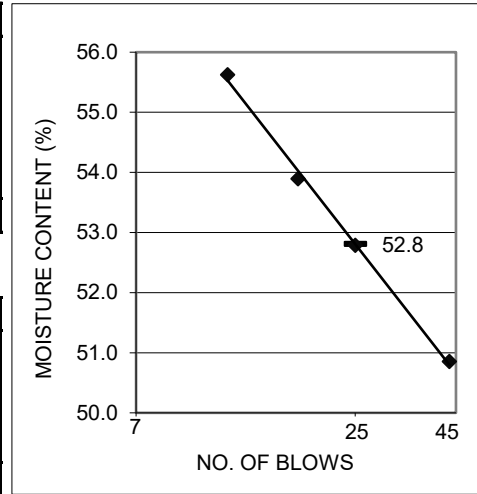

PLASTIC LIMIT

	1	2	AVERAGE
Container No.	5	6	
Wet Soil + Container	28.74	29.04	
Dry Soil + Container	26.91	27.14	
Wt. Of Container	18.87	18.78	
Moisture Content	22.8	22.7	22.7

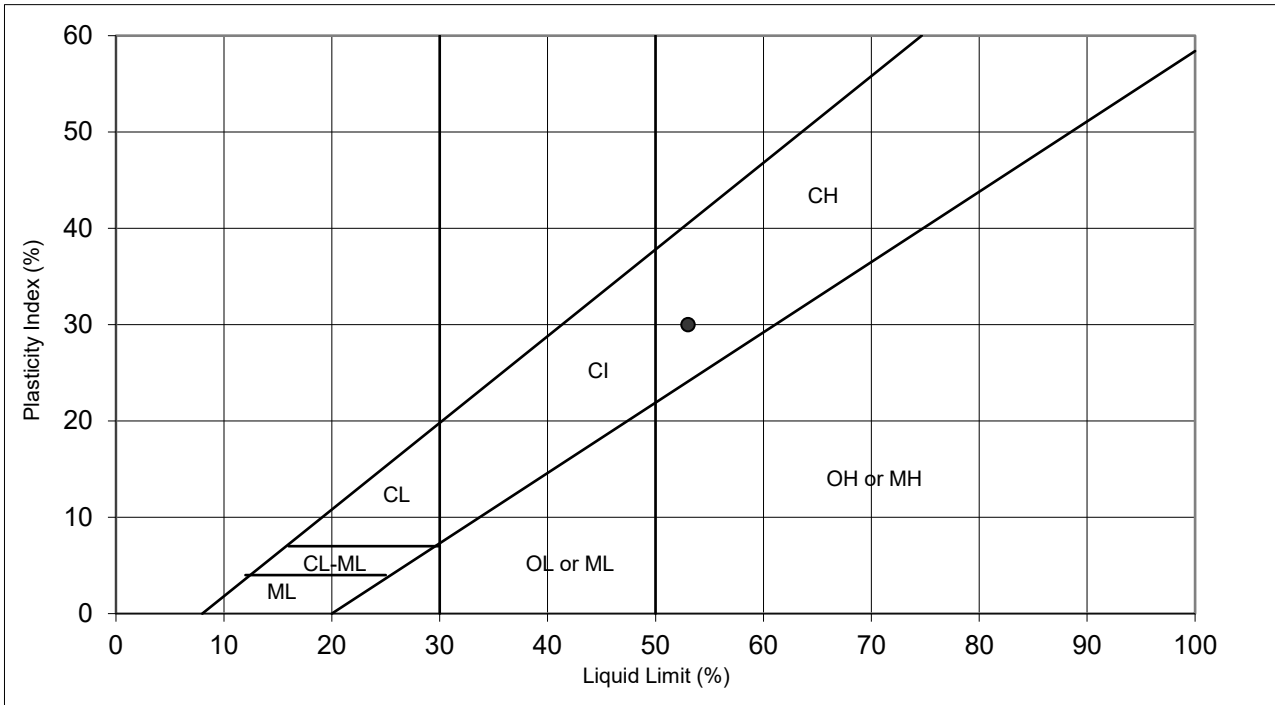

REMARKS

Liquid Limit:	53
Plastic Limit:	23
Plasticity Index:	30
USC Classification:	CH



ATTERBERG LIMITS
ASTM D4318

Client: CIMA+
Project: Terwillegar Drive Stage Two
Project No: 30442
Test Hole: TH21-21
Sample No: P25
Depth: 17.53 - 17.98 m

Date Tested: 04-May-21
Tested By: LLK
Checked By:

LIQUID LIMIT

Trial No:	1	2	3	4
No of Blows:	34	20	12	
Container No.	1	2	3	4
Wet Soil + Container	22.05	21.48	22.35	
Dry Soil + Container	16.85	16.19	16.62	
Wt. Of Container	0	0	0	0
Moisture Content	30.9	32.7	34.5	

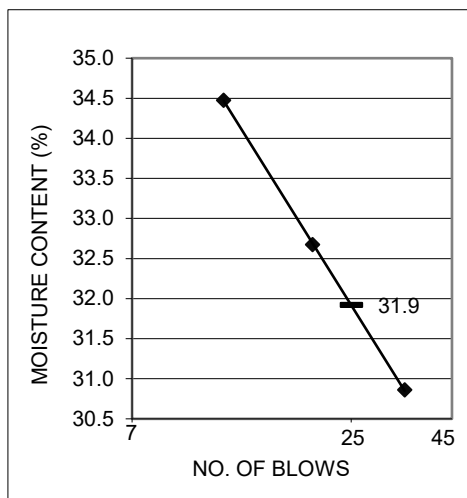

PLASTIC LIMIT

	1	2	AVERAGE
Container No.	5	6	
Wet Soil + Container	31.09	31.5	
Dry Soil + Container	29.51	29.85	
Wt. Of Container	18.89	18.71	
Moisture Content	14.9	14.8	14.8

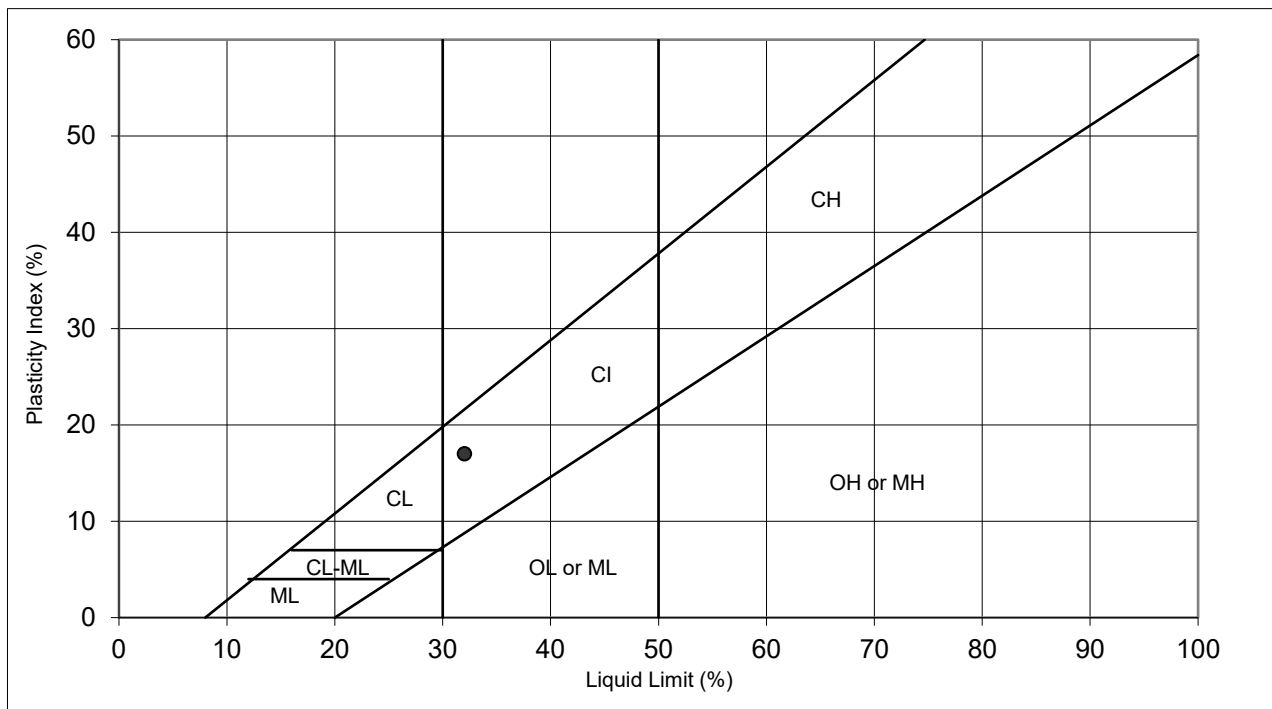

REMARKS

Liquid Limit:	32
Plastic Limit:	15
Plasticity Index:	17
USC Classification:	CI



THURBER ENGINEERING LTD.

4127 Roper Road Edmonton, AB T6B 3S5 T. (780) 438 - 1460 F. (780) 437 - 7125 www.thurber.ca

GRAIN SIZE DISTRIBUTION REPORT

Client: CIMA+
Project: Terwillegar Drive Stage Two
Project No: 30442

Date Tested: 06-May-21

Tested By: LLK

Test Hole: TH21-21

Depth: 11.43 - 11.89 m

Sample Description:

Sample No.: P17

Sieve Size -mm	Percent Finer
100.0	100.0
75.0	100.0
62.5	100.0
50.0	100.0
37.5	100.0
25.0	100.0
19.0	100.0
12.5	100.0
9.5	100.0
4.75	99.6
2.00	99.4
0.850	99.4
0.425	99.3
0.250	99.3
0.150	99.2
0.075	91.1
0.048	67.6
0.038	53.6
0.029	40.9
0.020	27.1
0.012	16.9
0.009	13.4
0.006	10.7
0.004	9.8
0.003	8.0
0.002	7.1

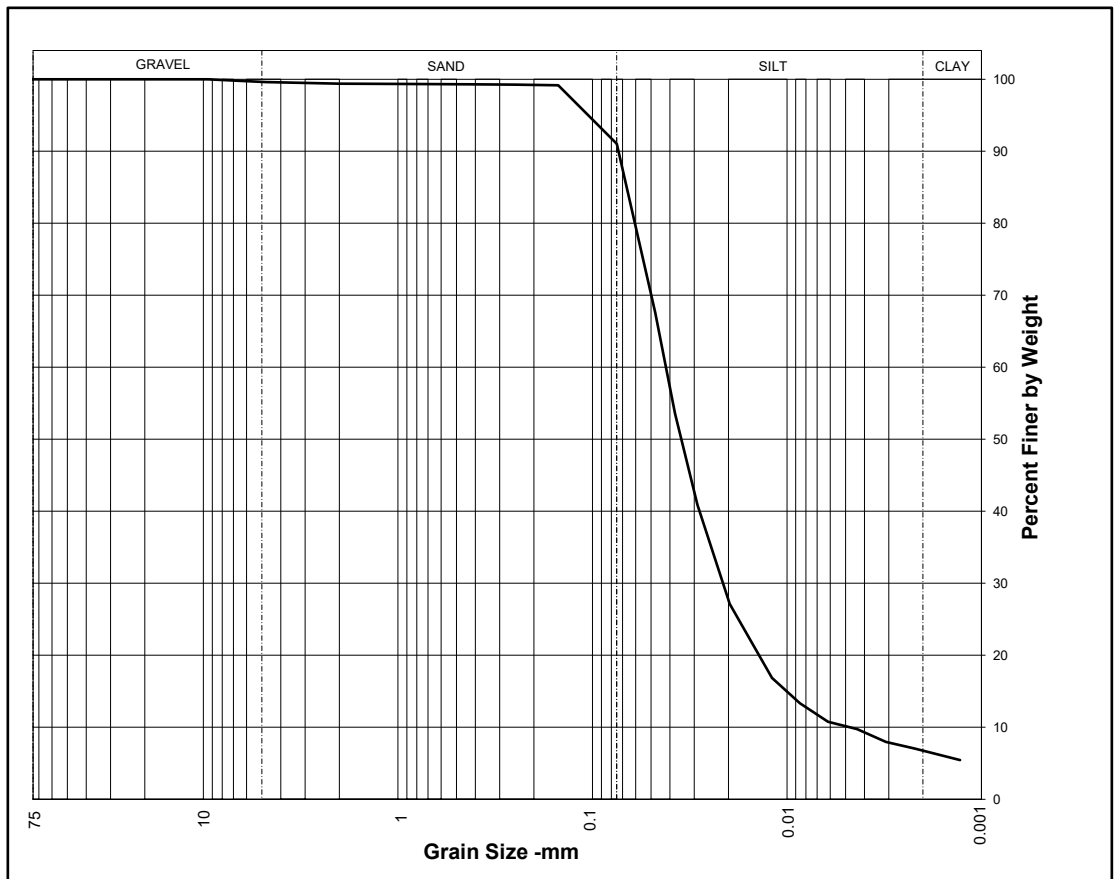

Distribution	
Cobbles	0%
Gravel	0.4%
Sand	8.6%
Silt	84.3%
Clay	6.7%

Remarks:

Checked By:

Tested in Accordance with ASTM D422, C136 and C117 unless otherwise indicated

**THURBER ENGINEERING LTD.
UNCONFINED COMPRESSION TEST REPORT**

CIMA+
FILE NUMBER : 30442

REPORT DATE: April 6/21
REPORT NUMBER UC21-1

Terwillegar Drive Stage II

TEST DATE: April 5/21
SAMPLE: TH21-15 @ 14.48 - 14.94m
DESCRIPTION: Clay Till (CI), silty some sand, trace coal, gravel, clay stone nodules, trace silt pockets, grey

SPECIMEN DETAILS:

Wet Density (kg/m³): 2188
Dry Density (kg/m³): 1881
Moisture Content (%): 16.3

Liquid Limit (%): -
Plastic Limit (%): -
Plasticity Index (%): -

Gravel (%): -
Sand (%): -
Silt (%): -
Clay (%): -

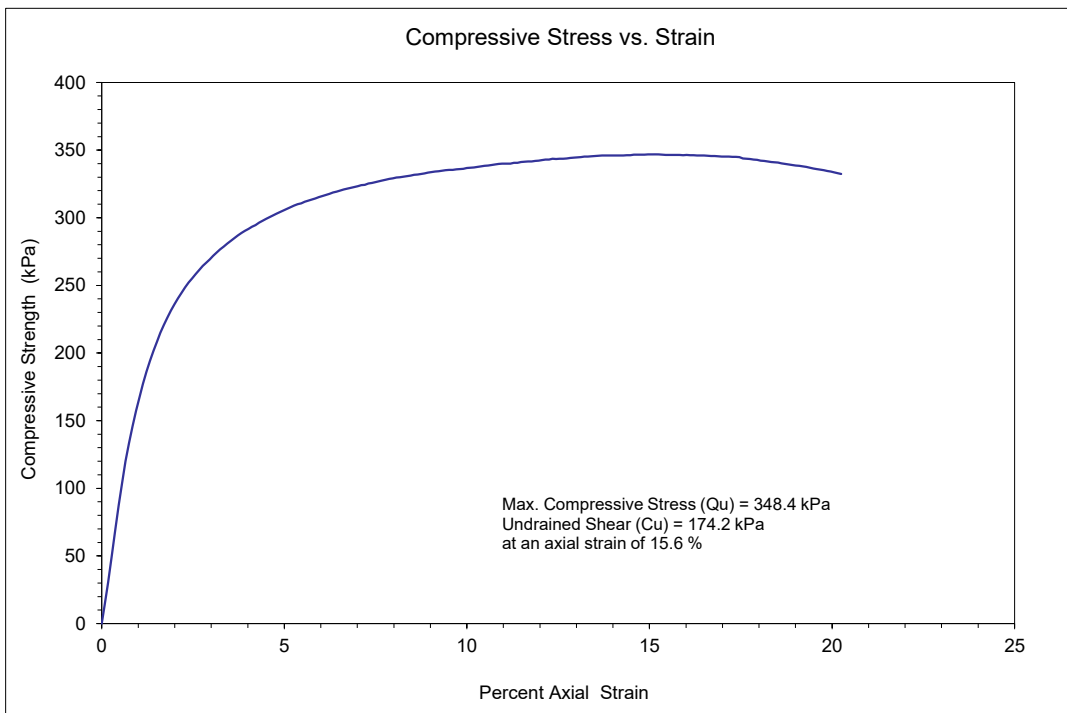

DIRECT SHEAR TEST REPORT DS21-1
 Terwillegar Drive Stage II
 TH21-15 @ 5.33 – 5.79 m

CIMA+
 File Number: 30442

Report Date: April 19/21

Normal Stress (kPa)	80	150	300
Peak Shear Stress (kPa)	53	102	162
Residual Shear Stress (kPa)	44	88	133

As Set Up

Wet Density (kg/m ³)	1802	1772	1806
Dry Density (kg/m ³)	1355	1326	1366
Water Content (%)	33.0	33.6	32.2
Degree of Saturation (%)	90	87	89
Void Ratio	0.99	1.04	0.98

After Consolidation

Dry Density (kg/m ³)	1411	1417	1425
Void Ratio	0.91	0.99	0.89
Coeff. Of Consolidation (cm ² /sec)	1.47e-2	3.80e-3	3.13e-3

After Test Water Content (%)

Shear Zone	34.7	31.5	28.4
Rest of Specimen	36.4	35.8	32.3

NOTE: Void Ratio calculated using an assumed Specific Gravity of 2.70.

Liquid Limit	45	Gravel (%)	-
Plastic Limit	28	Sand (%)	-
Plasticity Index	17	Silt (%)	-
		Clay (%)	-

Three direct shear specimens were trimmed from a 72mm diameter Shelby tube sample. The sample was a brown and grey silty Clay (CI). All three specimens were consolidated in two stages. The consolidation data was used to calculate a rate of strain that ensured drained conditions during the peak cycle. After the peak shear strength had been achieved, the rate of strain was increased to develop the residual shear strength on all three tests.

DIRECT SHEAR TEST REPORT DS21-1
TH21-15 @ 5.33 – 5.79 m

DS21-1a: Normal Stress = 80 kPa

Throughout the test there was no misalignment of the top and bottom halves of the shear box. At the end of the test the top cap sloped 3° away from the load cell and tilted 1° to one side.

There was a light amount of extruded material between the halves of the shear box. The extruded material was silt and clay, and the reservoir water was clear.

The shear surface was smooth, with a rough area at the end opposite the load cell. Plane was flat with shallow gouges at the end opposite the load cell and sloped up to the load cell end with a 2mm relief. The surface was softened.

Water content specimens were taken from the shear zone and from the rest of the specimen.

DS21-1b: Normal Stress = 150 kPa

Throughout the test there was no misalignment of the top and bottom halves of the shear box. At the end of the test the top cap sloped 3° away from the load cell.

There was a moderate amount of extruded material between the halves of the shear box. The extruded material was silt and clay, and the reservoir water was clear.

The shear surface was rough at the end opposite the load cell and along both sides. Smooth and polished at the load cell end. Plane was raised to center with a 1mm relief, and the surface was softened.

Water content specimens were taken from the shear surfaces and from the rest of the specimen.

DIRECT SHEAR TEST REPORT DS21-1
TH21-15 @ 5.33 – 5.79 m

DS21-1c: Normal Stress = 300 kPa

Throughout the test there was no misalignment of the top and bottom halves of the shear box. At the end of the test the top cap sloped 4° away from the load cell.

There was a heavy amount of extruded material between the halves of the shear box. The extruded material was silt and clay, and the reservoir water was clear.

The shear surface was smooth, with polished areas. Plane was raised to center with a 3mm relief, and the surface was softened.

Water content specimens were taken from the shear surfaces and from the rest of the specimen.



THURBER ENGINEERING LTD.

Direct Shear Test Results

Client: CIMA+
Project: Terwillegar Drive Stage II
Job No.: 30442

Test Hole: TH21-15
Sample: Clay(CI),
silty, brown and grey.
Depth: 5.33 - 5.79 m
Date: April 26/21

Peak Strength Parameters:
 $c' = 21\text{kPa}$ $\Phi' = 26^\circ$
Residual Strength Parameters:
 $c' = 0\text{ kPa}$ $\Phi' = 25^\circ$

Δ Peak Strength
 \bullet Residual Strength

Atterberg Limits: LL= 45% PL= 28% PI= 17%

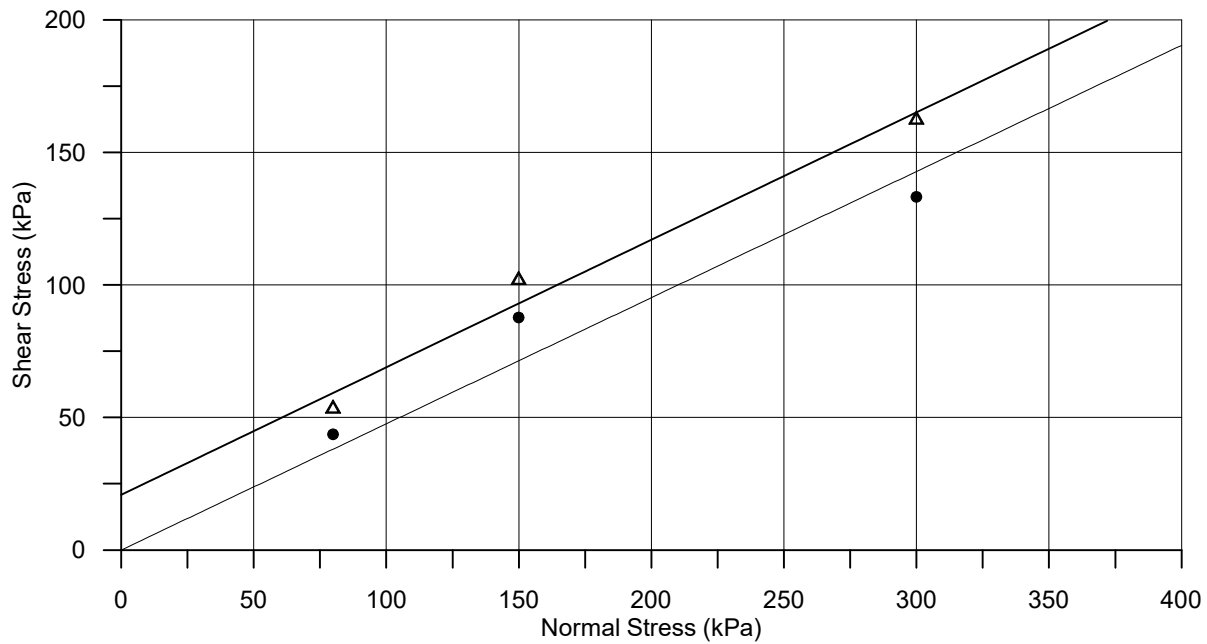

Remarks:

DIRECT SHEAR TEST REPORT DS21-4
 Terwillegar Drive Stage II
 TH21-21 @ 3.81 – 4.27 m

CIMA+
 File Number: 30442

Report Date: May 13/21

Normal Stress (kPa)	100	200	400
Peak Shear Stress (kPa)	77	133	163
Residual Shear Stress (kPa)	29	42	54

As Set Up

Wet Density (kg/m ³)	2015	1997	2034
Dry Density (kg/m ³)	1621	1595	1667
Water Content (%)	24.3	25.2	22.0
Degree of Saturation (%)	98	97	95
Void Ratio	0.68	0.71	0.63

After Consolidation

Dry Density (kg/m ³)	1627	1651	1726
Void Ratio	0.67	0.65	0.58
Coeff. Of Consolidation (cm ² /sec)	8.74e-4	1.74e-4	1.87e-4

After Test Water Content (%)

Shear Zone	32.6	33.9	26.4
Rest of Specimen	25.6	26.6	21.9

NOTE: Void Ratio calculated using an assumed Specific Gravity of 2.75.

Liquid Limit	53	Gravel (%)	-
Plastic Limit	23	Sand (%)	-
Plasticity Index	30	Silt (%)	-
		Clay (%)	-

Three direct shear specimens were trimmed from a 72mm diameter Shelby tube sample. The sample was a brown silty Clay (CI - CH). All three specimens were consolidated in two stages. The consolidation data was used to calculate a rate of strain that ensured drained conditions during the peak cycle. After the peak shear strength had been achieved, the rate of strain was increased to develop the residual shear strength on all three tests.

DIRECT SHEAR TEST REPORT DS21-3
TH21-21 @ 3.81 – 4.27 m

DS21-4a: Normal Stress = 100 kPa

Throughout the test there was no misalignment of the top and bottom halves of the shear box. At the end of the test the top cap sloped 3° away from the load cell.

There was a light amount of extruded material between the halves of the shear box. The extruded material was silt and clay with sand grains, and the reservoir water was clear.

The shear surface was smooth, with polished areas. The plane was undulated and sloped up to the load cell end with a 2mm relief. The surface was softened.

Water content specimens were taken from the shear zone and from the rest of the specimen.

DS21-4b: Normal Stress = 200 kPa

Throughout the test there was no misalignment of the top and bottom halves of the shear box. At the end of the test the top cap sloped 6° away from the load cell.

There was a moderate amount of extruded material between the halves of the shear box. The extruded material was silt and clay with sand grains, and the reservoir water was clear.

The shear surface was smooth, polished, and striated. The plane was undulated and raised to center with a 1mm relief. The surface was softened with a small pebble on the plane.

Water content specimens were taken from the shear surfaces and from the rest of the specimen.

DIRECT SHEAR TEST REPORT DS21-3
TH21-21 @ 3.81 – 4.27 m

DS20-4c: Normal Stress = 400 kPa

Throughout the test there was no misalignment of the top and bottom halves of the shear box. At the end of the test the top cap sloped 10° away from the load cell and tilted slightly to one side.

There was a heavy amount of extruded material between the halves of the shear box. The extruded material was silt and clay with sand grains, and the reservoir water was slightly murky.

The shear surface was smooth, polished, and striated. The plane was undulated and raised off center with a 3mm relief and the surface was softened.

Water content specimens were taken from the shear surfaces and from the rest of the specimen.



THURBER ENGINEERING LTD.

Direct Shear Test Results

Client: CIMA+
Project: Terwillegar Drive Stage II
Job No.: 30442

Test Hole: TH21-21
Sample: Clay (CI-CH),
silty, trace sand, brown.
Depth: 3.81 - 4.27 m
Date: May 13/21

Peak Strength Parameters:
 $c' = 32 \text{ kPa}$ $\Phi' = 22^\circ$
Residual Strength Parameters:
 $c' = 0 \text{ kPa}$ $\Phi' = 16^\circ$

Δ Peak Strength
 \bullet Residual Strength

Atterberg Limits: LL= 531% PL= 23% PI= 30%

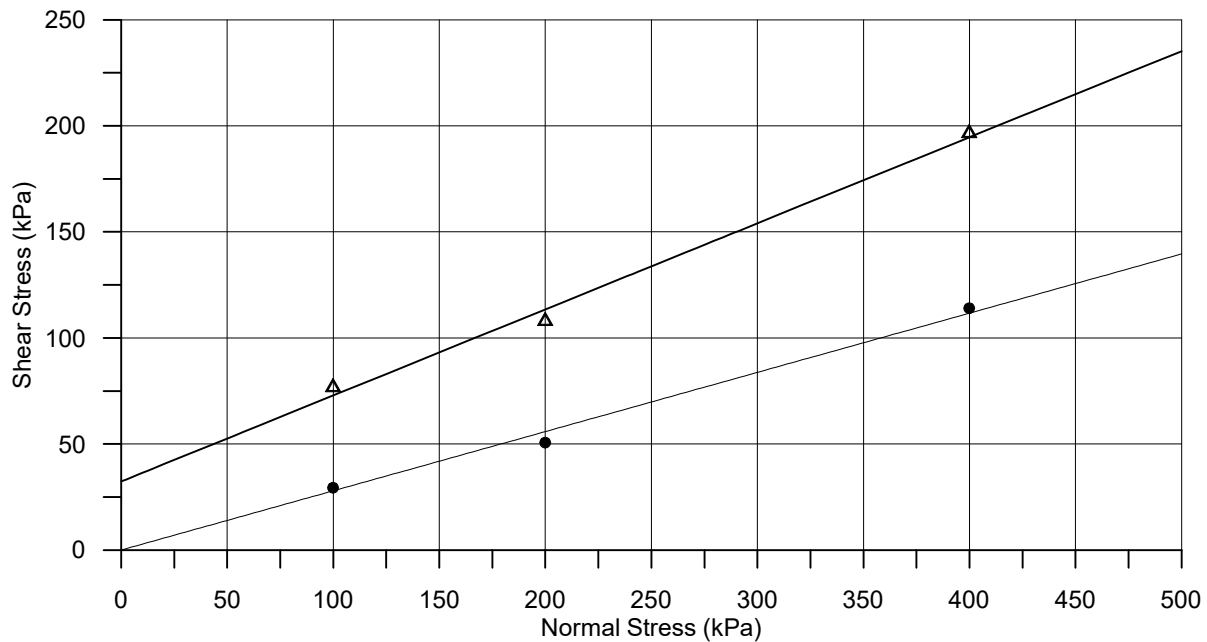

Remarks:

THURBER ENGINEERING LTD. CYCLIC COMPRESSION TEST REPORT

CIMA+
FILE NUMBER : 30442

REPORT DATE: May 15/21
REPORT NUMBER: CC21-7

Terwillegar Drive Stage II

TEST DATE: May 14/21
SAMPLE: TH21-21 @ 22.1 - 22.56 m
DESCRIPTION: Clay till (Cl), silty, some sand, trace coal, gravel, claystone nodules, grey.

SPECIMEN DETAILS:

Wet Density (kg/m³): 2130
Dry Density (kg/m³): 1824
Water Content (%): 16.7

Liquid Limit (%):
Plastic Limit (%):
Plasticity Index (%):

Gravel (%):
Sand (%):
Silt (%):
Clay (%):

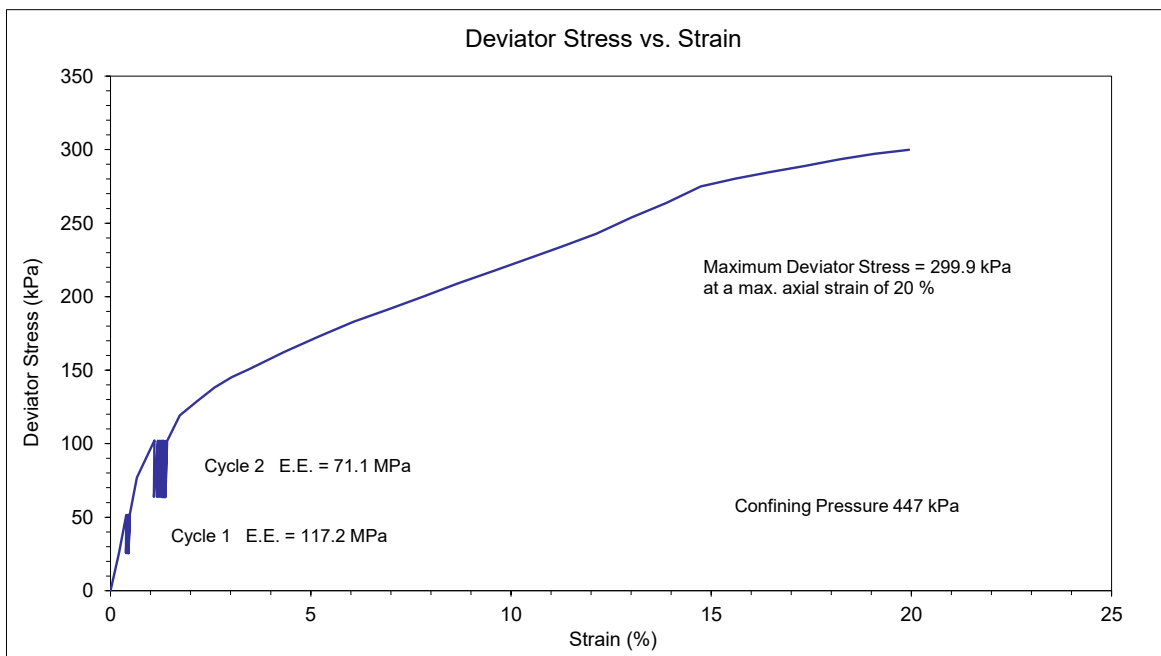



THURBER ENGINEERING LTD.

4127 Roper Road
Edmonton, Alberta T6B 3S5
Phone (780) 438-1460 | Fax (780) 437-7125

Job No:	30442		
Client:	CIMA+		
Project:	Terwillegar Drive Stage Two		
HOLE/PIT:	TH21-15	SAMPLE:	B4
DEPTH:	3.05 m	TECH:	AAC
DATE:	9-Apr-21	CHECKED BY:	

SULPHATE TEST ON SOILS USING PFRA METHOD

BEAKER NO: 11-7/24 CRUCIBLE NO: 20-7

- 1- Add 100 g of oven dried soil, passing No. 40 sieve.
- 2- Add 500 mL of distilled water - or ratio of 20 g of soil to 100 g of water.
- 3- Add 3 drops of concentrated HCL acid.
- 4- Place mixture in oven (110C, 250F) for 1 hour or allow to sit overnight.
- 5- Draw off or filter 100 mL clear liquid from mixture into 250 mL beaker.
- 6- Add 100 mL distilled water on 5 mL concentrated HCL acid.
- 7- Heat in oven for 1 hour.
- 8- Add 10 mL of 10% BACL2 solution, mix thoroughly, observe reaction.

<input type="checkbox"/>	Clear Solution No Reaction	<input checked="" type="checkbox"/>	Slightly Milky No Precipitate	<input type="checkbox"/>	Milky Solution With Precipitate
--------------------------	-------------------------------	-------------------------------------	----------------------------------	--------------------------	------------------------------------

- 9- Filter mixture through crucible on vacuum setup, dry crucible thoroughly in oven

Wt of Crucible + BaSO4 (ppt) (oven dried)	<u>25.81</u>	g
WTt of Crucible Empty	<u>25.8</u>	g
Wt of BaSO4 (ppt)	<u>0.01</u>	g
Wt of Soil Used (passing No. 40 sieve)	<u>100.81</u>	g

CALCULATIONS

Gravimetric Factor

$$\text{Wt of Sulphate} = \frac{\text{Wt BaSO}_4 \text{ (ppt) gms}}{\text{Gravimetric Factor}} = \frac{0.01}{2.60} = 0.004 \text{ g}$$

$$\text{Percent Sulphate} = \frac{\text{Wt of SO}_4 \times 100\%}{\text{Wt of Soil Used (g)}} = \frac{0.38}{20.162} = 0.02 \%$$

<input checked="" type="checkbox"/>	0-0.1%	Clear Solution, No reaction
<input type="checkbox"/>	0.1-0.5%	Slightly Milky, No Precipitation Dangerous if Water Table is Too High
<input type="checkbox"/>	>0.5%	Milky with Precipitate Dangerous, use HS Cement



THURBER ENGINEERING LTD.

4127 Roper Road
Edmonton, Alberta T6B 3S5
Phone (780) 438-1460 | Fax (780) 437-7125

Job No:	30442		
Client:	CIMA+		
Project:	Terwillegar Drive Stage Two		
HOLE/PIT:	TH21-21	SAMPLE:	B12
DEPTH:	7.62 m	TECH:	LLK
DATE:	30-Apr-21	CHECKED BY:	

SULPHATE TEST ON SOILS USING PFRA METHOD

BEAKER NO: K2/D3 CRUCIBLE NO: _____

- 1- Add 100 g of oven dried soil, passing No. 40 sieve.
- 2- Add 500 mL of distilled water - or ratio of 20 g of soil to 100 g of water.
- 3- Add 3 drops of concentrated HCL acid.
- 4- Place mixture in oven (110C, 250F) for 1 hour or allow to sit overnight.
- 5- Draw off or filter 100 mL clear liquid from mixture into 250 mL beaker.
- 6- Add 100 mL distilled water on 5 mL concentrated HCL acid.
- 7- Heat in oven for 1 hour.
- 8- Add 10 mL of 10% BACL2 solution, mix thoroughly, observe reaction.

X	Clear Solution No Reaction		Slightly Milky No Precipitate		Milky Solution With Precipitate
---	-------------------------------	--	----------------------------------	--	------------------------------------

- 9- Filter mixture through crucible on vacuum setup, dry crucible thoroughly in oven

Wt of Crucible + BaSO4 (ppt) (oven dried)	_____ g
WTt of Crucible Empty	<u>25.66</u> g
Wt of BaSO4 (ppt)	<u>0</u> g
Wt of Soil Used (passing No. 40 sieve)	<u>100.03</u> g

CALCULATIONS

Gravimetric Factor

$$\text{Wt of Sulphate} = \frac{\text{Wt BaSO}_4 \text{ (ppt) gms}}{\text{Gravimetric Factor}} = \frac{0}{2.60} = 0.000 \text{ g}$$

$$\text{Percent Sulphate} = \frac{\text{Wt of SO}_4 \times 100\%}{\text{Wt of Soil Used (g)}} = \frac{0.00}{20.006} = 0.00 \%$$

	0-0.1%	Clear Solution, No reaction
	0.1-0.5%	Slightly Milky, No Precipitation Dangerous if Water Table is Too High
	>0.5%	Milky with Precipitate Dangerous, use HS Cement

DRAFT

APPENDIX D

Global Stability Analysis Results

Color	Name	Model	Unit Weight (kN/m³)	Cohesion (kPa)	Piezometric Line
■	Clay (Undrained)	Undrained (Phi=0)	19	60	1
■	Clay Till (with Interbedded Silt and Sand) (Undrained)	Undrained (Phi=0)	19	150	1

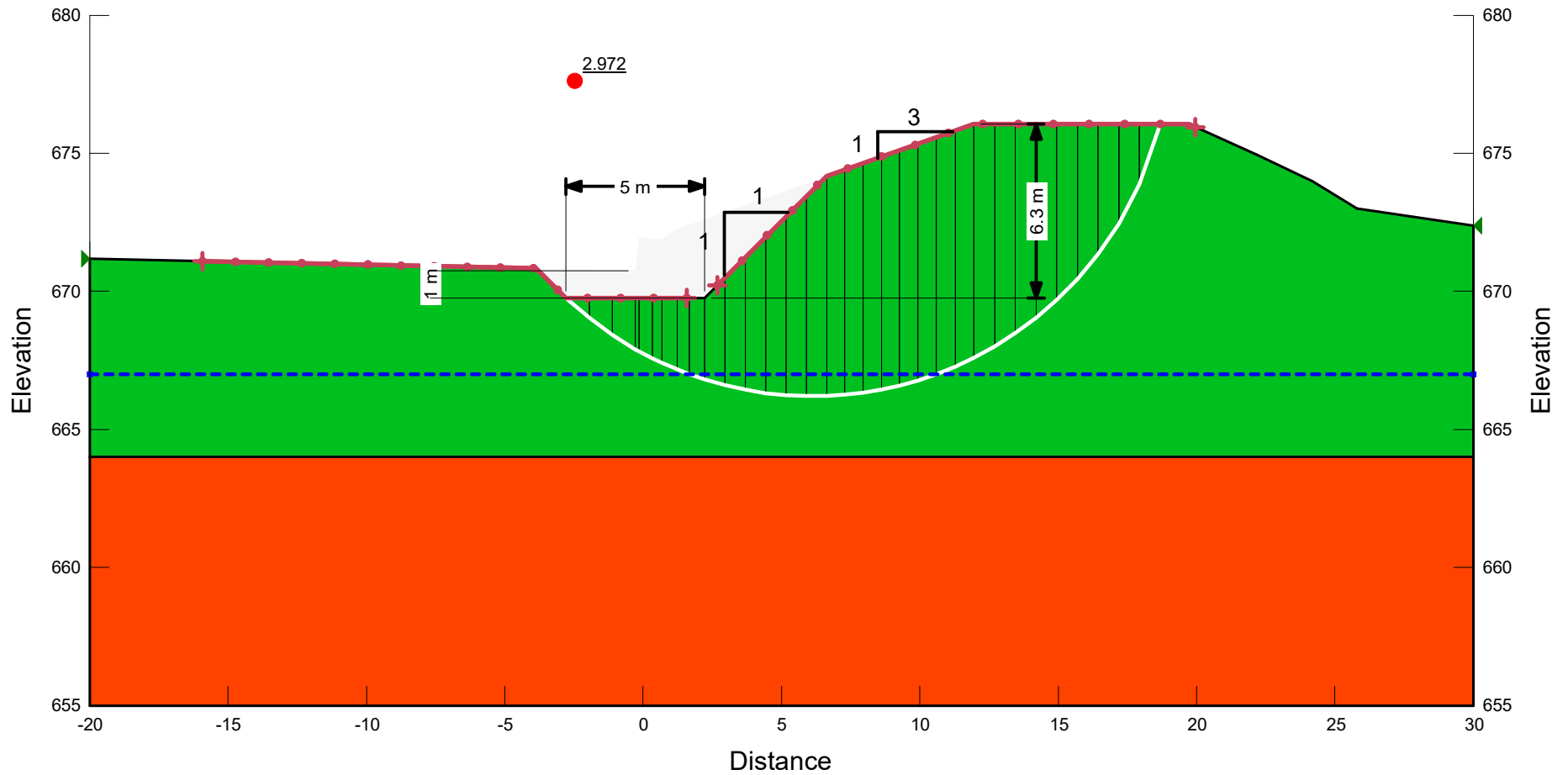

	Project		Retaining Wall 1 (East of Northbound Terwillegar Drive)		Additional Details Name: 2D Geometry Comments: Section B - B' Method: Morgenstern-Price, Half-Sine Minimum Slip Surface Depth: 0.1 m Entry: (18.684553, 676.0564) m, Exit: (-2.7829761, 669.75636) m Centre: (6.1201191, 679.14443) m, Radius: 12.938351 m
	Analysis		Section B - B': Excavation for Wall: Short-Term (Undrained)		
	Seismic Coefficient	Last Run	Scale		
H: 0g, V: 0g		2021-08-09, 11:08:23 AM	1:230		

Figure D.1

Color	Name	Model	Unit Weight (kN/m ³)	Effective Cohesion (kPa)	Effective Friction Angle (°)	Piezometric Line	Ru	Include Ru in PWP
Light Green	Clay	Mohr-Coulomb	19	10	22	1	0.2	Yes
Orange	Clay Till (with Interbedded Silt and Sand)	Mohr-Coulomb	19	5	28	1	0.2	Yes

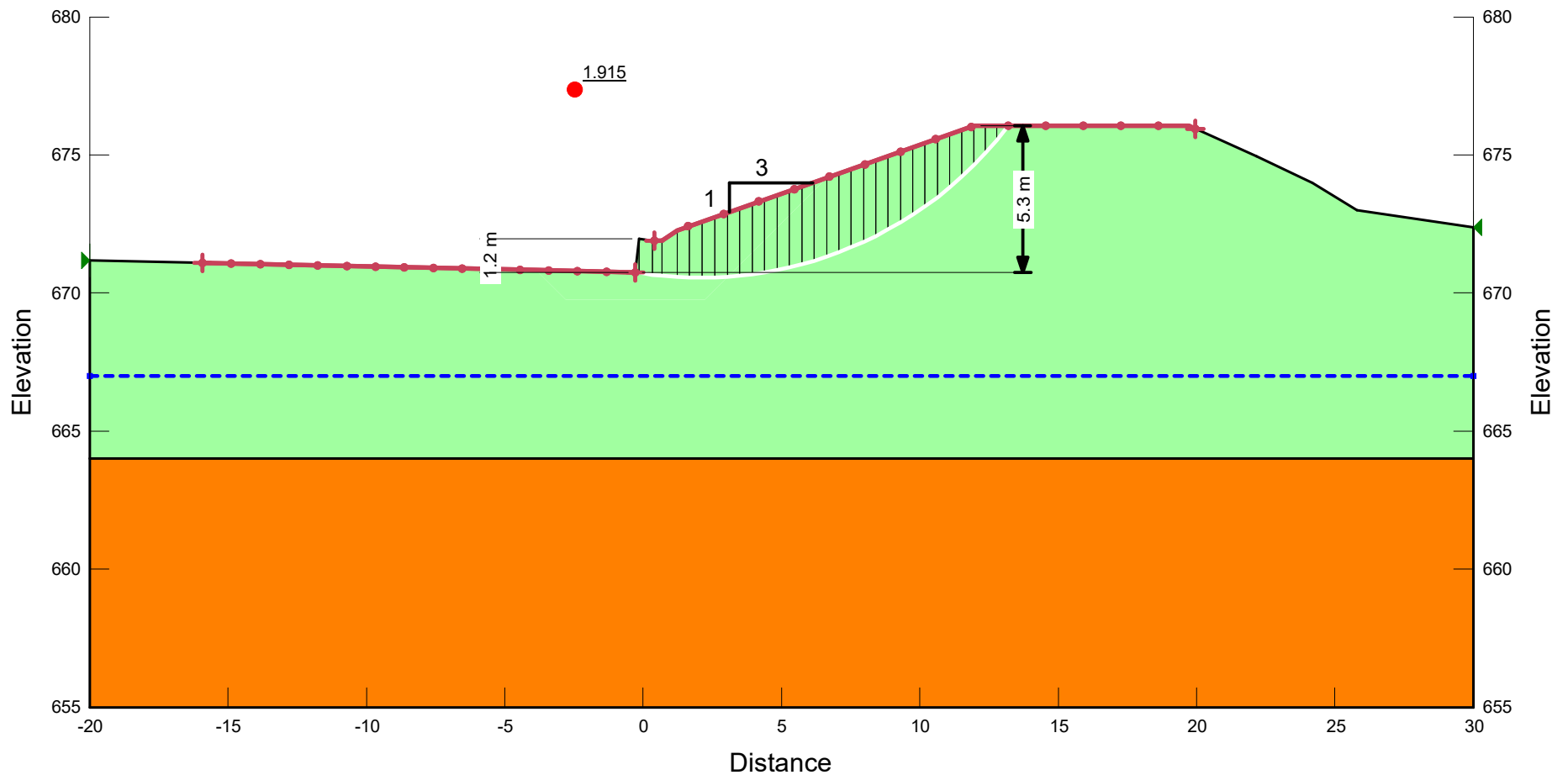

	Project	Retaining Wall 1 (East of Northbound Terwillegar Drive)		Additional Details	Name: 2D Geometry Comments: Section B - B' Method: Morgenstern-Price, Half-Sine Minimum Slip Surface Depth: 0.1 m Entry: (13.19634, 676.0564) m, Exit: (-0.28904, 670.75636) m Centre: (2.081337, 684.53126) m, Radius: 13.977357 m
	Analysis	Section B - B': Cantilever Retaining Wall: Long-Term (Drained)			
	Seismic Coefficient	Last Run	Scale		
	H: 0g, V: 0g	2021-08-09, 11:08:24 AM	1:230		

Figure D.2

Color	Name	Model	Unit Weight (kN/m³)	Cohesion (kPa)	Piezometric Line
Blue	Bedrock (Undrained)	Undrained (Phi=0)	20	200	1
Green	Clay (Undrained)	Undrained (Phi=0)	19	60	1
Orange	Clay Till (with Interbedded Silt and Sand) (Undrained)	Undrained (Phi=0)	19	150	1

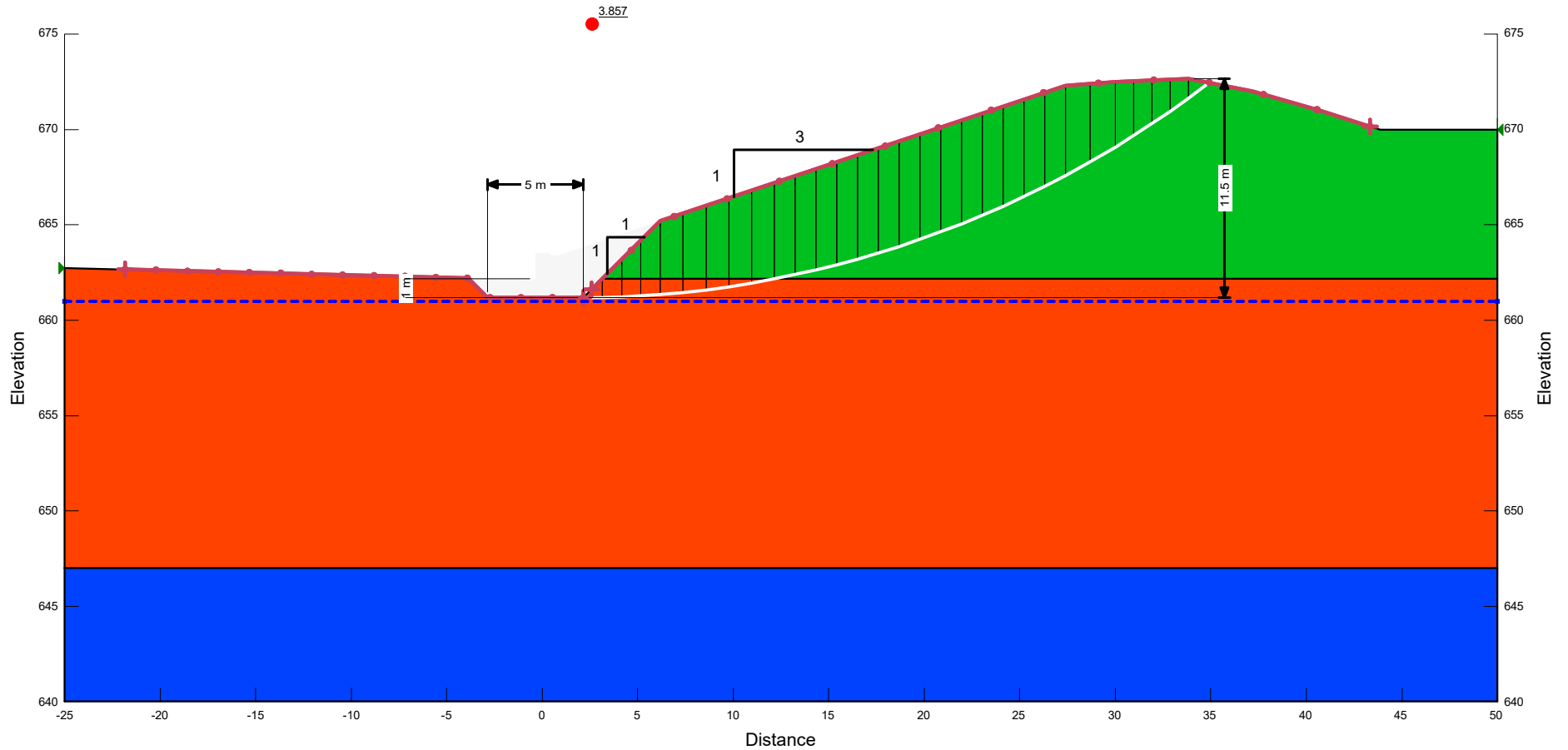

Project		Retaining Wall 2 (South of EB Whitemud Drive)	
Analysis		Section D - D': Excavation for Wall: Short-Term (Undrained)	
Seismic Coefficient	Last Run	Scale	
H: 0g, V: 0g	2021-08-09, 03:06:05 PM	1:330	

Additional Details	
Name:	2D Geometry
Comments:	Section D - D'
Method:	Morgenstern-Price, Half-Sine
Minimum Slip Surface Depth:	0.1 m
Entry:	(34.908329, 672.46171) m, Exit: (2.147472, 661.17629) m
Centre:	(1.790882, 715.40551) m, Radius: 54.230395 m

Figure D.3

Color	Name	Model	Unit Weight (kN/m ³)	Effective Cohesion (kPa)	Effective Friction Angle (°)	Piezometric Line	Ru	Include Ru in PWP
Blue	Bedrock	Mohr-Coulomb	20	20	20	1		No
Light Green	Clay	Mohr-Coulomb	19	10	22	1	0.2	Yes
Orange	Clay Till (with Interbedded Silt and Sand)	Mohr-Coulomb	19	5	28	1	0.2	Yes

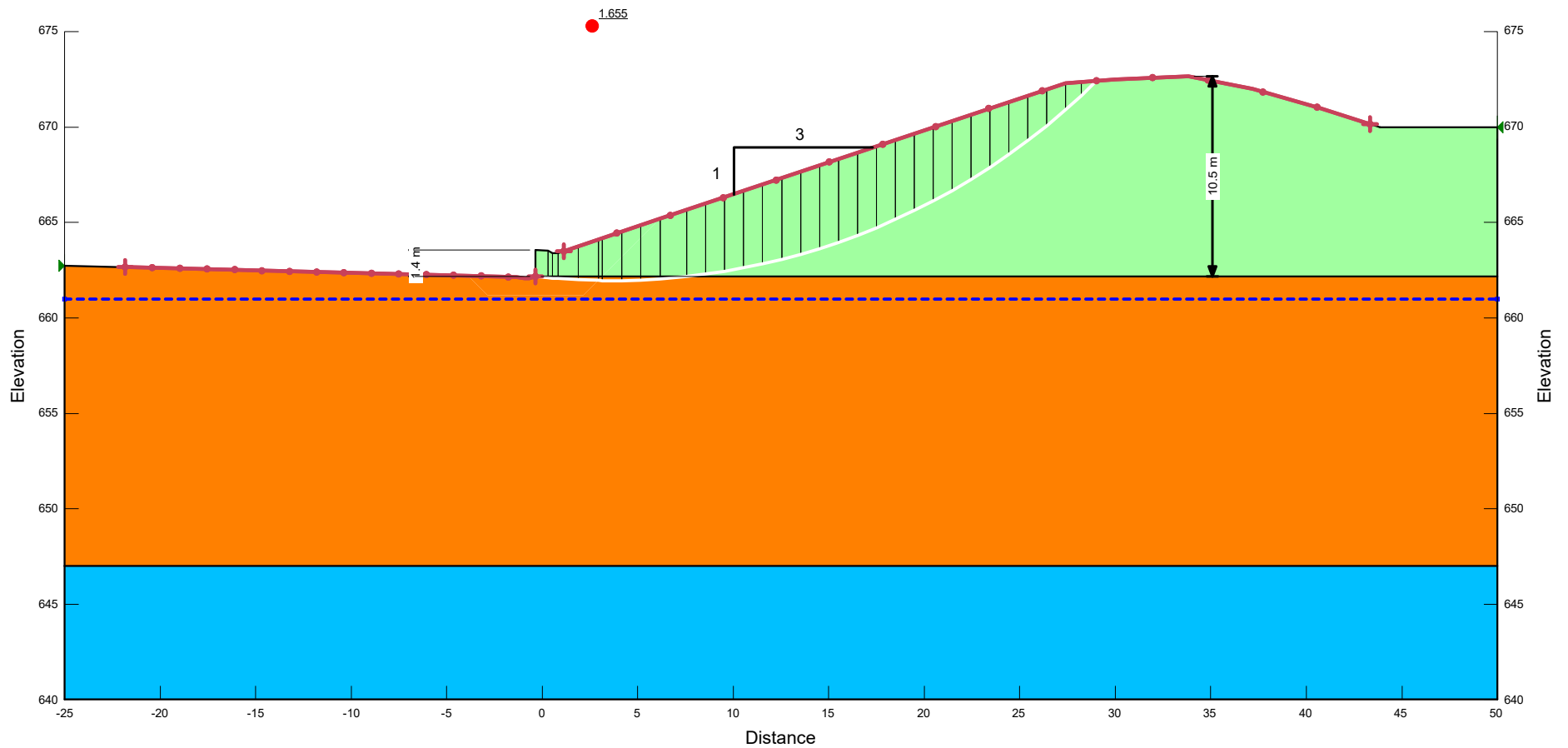

	Project		Retaining Wall 2 (South of EB Whitemud Drive)		Additional Details	
	Analysis		Section D - D': Cantilever Retaining Wall: Long-Term (Drained)		Name: 2D Geometry Comments: Section D - D' Method: Morgenstern-Price, Half-Sine Minimum Slip Surface Depth: 0.1 m	
	Seismic Coefficient	Last Run	Scale	Entry: (29.018052, 672.44589) m, Exit: (-0.352528, 662.17629) m Centre: (3.6110728, 697.97463) m, Radius: 36.017102 m		
H: 0g, V: 0g	2021-08-09, 03:06:03 PM	1:330				

Figure D.4

APPENDIX D - LIMITED PHASE I ENVIRONMENTAL SITE ASSESSMENT



Associated
Engineering

GLOBAL PERSPECTIVE.
LOCAL FOCUS.

REPORT

City of Edmonton

Limited Phase I Environmental Site Assessment
Rainbow Valley Bridges Renewal & Widening /
Terwillegar Drive Stage 2 Upgrades
2019-3585



AUGUST 2020

A Carbon
Neutral
Company



CONFIDENTIALITY AND © COPYRIGHT

This document is for the sole use of the addressee and Associated Engineering Alberta Ltd. The document contains proprietary and confidential information that shall not be reproduced in any manner or disclosed to or discussed with any other parties without the express written permission of Associated Engineering Alberta Ltd. Information in this document is to be considered the intellectual property of Associated Engineering Alberta Ltd. in accordance with Canadian copyright law.

This report was prepared by Associated Engineering Alberta Ltd. for the account of City of Edmonton. The material in it reflects Associated Engineering Alberta Ltd.'s best judgement, in the light of the information available to it, at the time of preparation. Any use which a third party makes of this report, or any reliance on or decisions to be made based on it, are the responsibility of such third parties. Associated Engineering Alberta Ltd. accepts no responsibility for damages, if any, suffered by any third party as a result of decisions made or actions based on this report.

EXECUTIVE SUMMARY

Associated Engineering Alberta Ltd. (Associated) was retained by the City of Edmonton to conduct a Limited Phase I Environmental Site Assessment (ESA) along a 4.9-kilometre (km) segment of Whitemud Drive (WMD) in Edmonton, Alberta (Site). The Site includes the WMD-Fox Drive interchange, WMD-Terwillegar Drive interchange, Rainbow Valley Bridges (RVB), and the WMD-122 Street interchange and surrounding area. Currently, the WMD freeway is divided and has three lanes of traffic going in both directions. Most of the area surrounding the Site is developed and consists of residential areas with schools, churches, and parks. The area surrounding RVB and Whitemud Creek is recreational, including trails, parking areas, Rainbow Valley campground, and Snow Valley Ski Club.

Engineering services at the Site will include assessing the condition of the RVB and defining short-term repair requirements, improving accessibility for Rapid-Bus Transit Services to connect with the north end of Terwillegar Drive, and preparing a concept plan for widening WMD, RVB, and the WMD-Terwillegar Drive interchange bridges. Future work on the RVB will require excavation to widen the pier foundations on the edge of the creek. In addition, a pedestrian/cyclist bridge crossing WMD is planned for 142 Street.

This study was initiated for project planning and environmental due diligence purposes as part of conceptual planning. The assessment was conducted in general accordance with the Canadian Standards Association (CSA) Z768-01-R2016 – Phase I Environmental Assessment, City of Edmonton’s Environmental Site Assessment Guidebook (City of Edmonton 2016), and the Alberta Government’s Phase I ESA standards, adhering to the Environmental Protection and Enhancement Act. The Limited Phase I ESA included desktop searches, record reviews, and a Site visit.

Based on the results of the Limited Phase I ESA, there is high potential that current or past land use activities at the Site have resulted in contamination of soil, vapour, and/or groundwater. There is one reported diesel spill area that was remediated however confirmatory sampling of chemicals commonly found within firefighting foams was not completed. This area is considered an area of potential environmental concern (APEC) (APEC 1). Salt staining was present along Whitemud Drive, and debris was scattered throughout the Site (APEC 2). There is low potential that current or past land use activities at neighbouring properties have resulted in contamination of soil, vapour, and/or groundwater at the Site. No APECs were identified in properties neighbouring the Site.

Associated provides the following recommendations:

- Where present, all debris should be removed from the Site prior to any excavation work;
- Soils within or adjacent to APEC 1 should be assessed prior to construction or earthworks for potential contaminants of concern (PCOCs) that may require management;
- Soils adjacent to WMD that are to be disturbed during future construction/expansion should be assessed for PCOCs that may need to be managed;
- Any soils encountered during ground disturbance with indications of potential contamination such as odours, staining, or sheen should be assessed for PCOCs and may need to be managed.
- Should excavation surrounding Whitemud Creek occur below stream elevation, temporary re-routing of the stream and dewatering of the excavation may be required.

TABLE OF CONTENTS

SECTION	PAGE NO.
Executive Summary	i
Table of Contents	ii
List of Tables	iv
List of Abbreviations	v
1 Introduction	1
2 Scope	1
3 Location and Land Use	2
3.1 Location	2
3.2 Current and Neighbouring Land Use	2
3.3 Historical Land Use	3
4 Physical Setting	3
4.1 Topography	3
4.2 Surface Water Drainage, Nearby Receptors and Hydrogeology	3
4.3 Soils and Vegetation	3
4.4 Surficial Geology	4
4.5 Bedrock Geology	4
4.6 Climate	4
5 Records Review	4
5.1 Fire Insurance Plans	4
5.2 Drainage Records	4
5.3 Aerial Photographs	5
5.4 Water Well Records	8
5.5 Oil and Gas Wells and Pipelines	8
5.6 AER Spill Reports	9
5.7 Coal Mine Search	9
5.8 National Pollutant Release Inventory	10
5.9 Environmental Site Assessment Repository	10
5.10 City of Edmonton Records	13
5.11 Petroleum Tank Management Associated of Alberta	14
5.12 Environmental Law Centre Records	14
5.13 Freedom of Information and Protection of Privacy	14
5.14 Landfill Searches	14
6 Site Inspection	15

6.1	Buildings	15
6.2	Grounds	15
7	Indications of Environmental Risk	17
7.1	Site	17
7.2	Neighbouring Properties	17
8	Conclusions and Recommendations	18
	Closure	
	References	
	Appendix A – Site Figures	
	Appendix B – Municipal Land Plans	
	Appendix C - Drainage Records	
	Appendix D - Aerial Photographs	
	Appendix E - Water Well Records	
	Appendix F - Oil and Gas Wells and Pipelines	
	Appendix G - AER Spills and Complaints	
	Appendix H - Coal Mine Search	
	Appendix I - National Pollutant Release Inventory	
	Appendix J - Environmental Site Assessment Repository	
	Appendix K – Nichols Environmental (Canada) Ltd. - Spill Response and Remediation Program	
	Appendix L - Petroleum Tank Management Association of Alberta	
	Appendix M - Site Photographs	
	Appendix N - Standard Disclaimer	

LIST OF TABLES

	PAGE NO.
Table 5-1 Historical Aerial Photograph Analysis	6
Table 5-2 Alberta Environment and Parks Water Wells Within 500 m of the Site	8
Table 5-3 Alberta Energy Regulator Wellsites Within 500 m of the Site	9
Table 5-4 Alberta Energy Regulator Pipelines Within 500 m of the Site	9
Table 5-5 ESAR Search Results	11
Table 5-6 Soil Parameters Exceeding Guidelines in Nichols 2016 Report	13

LIST OF ABBREVIATIONS

Acronym	Definition
AEP	Alberta Environment and Parks
AER	Alberta Energy Regulator
AGRASID	Agricultural Regions of Alberta Soil Inventory Database
APEC	area of potential environmental concern
AT1	Alberta Tier 1 Soil and Groundwater Remediation Guidelines
ATS	Alberta Township System
BTEX F1-F4	benzene, toluene, ethylbenzene, xylenes and petroleum hydrocarbon fractions F1 to F4
ECCC	Environment and Climate Change Canada
ESA	environmental site assessment
ESAR	Environmental Site Assessment Repository
GoA	Government of Alberta
H.E.L.P.	Help End Landfill Pollution
LSD	legal subdivision
PAH	polycyclic aromatic hydrocarbons
PCE	polychloroethylene
PCOC	potential contaminant of concern
PFAS	per and polyfluoroalkyl substances
PFOA	perfluorooctanoic acid
PHC	petroleum hydrocarbons
PTMAA	Petroleum Tank Management Associated of Alberta
RMC	risk management criteria
RMP	risk management plan
ROW	right-of-way
RVB	Rainbow Valley Bridges
TCE	trichloroethylene
UST	underground storage tank
VOC	volatile organic compound
WMD	Whitemud Drive

Units	Definition
°C	degrees Celsius
km	kilometre
m	metre
masl	metres above sea level
mbgs	metres below ground surface



1 INTRODUCTION

Associated Engineering Alberta Ltd. (Associated) was retained by the City of Edmonton to conduct a Limited Phase I Environmental Site Assessment (ESA) along a 4.9-kilometre (km) segment of Whitemud Drive (WMD) in Edmonton, Alberta (Site). The Site includes the WMD-Fox Drive interchange, WMD-Terwillegar Drive interchange, Rainbow Valley Bridges (RVB), and the WMD-122 Street interchange. The Site details are provided in Figure 1 (Appendix A).

Engineering services will include assessing the condition of the RVB and defining short-term repair requirements, improving accessibility for Rapid-Bus Transit Services to connect with the north end of Terwillegar Drive, and preparing a concept plan for widening WMD, RVB, and the WMD-Terwillegar Drive interchange bridges. Future work on the RVB will require excavation to widen the pier foundations on the edge of Whitemud Creek. In addition, a pedestrian/cyclist bridge crossing WMD is planned for 142 Street.

This study was initiated for project planning and environmental due diligence purposes as part of conceptual planning. Due to the large project area this assessment is a Limited Phase I ESA. The assessment was conducted in general accordance with the Canadian Standards Association (CSA) Z768-01-R2016 – Phase I Environmental Assessment, City of Edmonton's Environmental Site Assessment Guidebook (City of Edmonton 2016), and the Alberta Government's Phase I ESA standards, adhering to the Environmental Protection and Enhancement Act.

2 SCOPE

The objective of this Limited Phase I ESA is to identify areas of potential environmental concern (APEC), and provide recommendations for further investigation (i.e. Phase I or Phase II ESA), if required.

The following methods were used to evaluate the level of environmental risk associated with the Site:

1. A summary of hydrogeological, geology, geotechnical, and environmental reports relevant to the Site.
2. An examination of aerial photographs of the Site and surrounding areas between 1950 and 2017 obtained from Alberta Environment and Parks (AEP) and Google Earth imagery.
3. A search of the City of Edmonton Fire Rescue plans, and drainage.
4. A search of AbaData mapping software to identify oil and gas wells on or adjacent to the Site.
5. A search of the Alberta Energy Regulator (AER) incident report spreadsheet and Abacus Datagraphics mapping software to identify documented spills that have occurred on or adjacent to the Site.
6. A search of the Alberta Energy Regulator (AER) Coal Mine Map Viewer to identify previous or existing coal mines within the area.
7. A search of the Alberta Water Well Information Database to gain knowledge on individual water wells drilled on or adjacent to the Site.
8. A search of the National Pollutant Release Inventory (NPRI) Virtual Globe (Google Earth) files to identify any releases on or adjacent to the Site.
9. A search of the Environmental Site Assessment Repository (ESAR) database. This database is regularly updated and often provides environmental records for sites with known occurrences of soil and/or groundwater contamination.
10. A search of the Petroleum Tank Management Associated of Alberta (PTMAA) for registered fuel storage tanks within the project footprint.
11. A site inspection conducted by Danielle Loiselle, G.I.T., Environmental Scientist, on April 22, 2020.

3 LOCATION AND LAND USE

3.1 Location

The Site covers a 4.9 km segment of the WMD freeway and ranges from approximately 100 to 200 metres in width. Currently, the freeway is divided and has three lanes of traffic going in both directions. The WMD Fox-Drive interchange accounts for 0.5 km of the Site length. The north-south segment from the WMD-Fox Drive interchange to the WMD-Terwillegar Drive interchange is approximately 2.3 km. The east-west segment from the WMD-Terwillegar Drive interchange to the WMD-122 Street interchange is approximately 2.1 km. The location of the planned pedestrian/cyclist bridge is 200 metres east of Terwillegar Drive, which will connect 142 Street north of WMD to a pathway south of WMD. The RVB cross Whitemud Creek and is approximately midway between Terwillegar Drive and 122 Street.

The Site intersects the following Alberta Township Survey System (ATS) sections:

- NW-07-52-24-W4M;
- SW-18-52-24-W4M;
- NE-11-52-25-W4M;
- NW & NE-12-52-25-W4M;
- SW & SE-13-52-25-W4M;
- NE & SE-14-52-25-W4M;
- SE-23-52-25-W4M; and
- SW-24-52-25-W4M.

The Site details are provided in Figure 1 (Appendix A).

3.2 Current and Neighbouring Land Use

Current land use at the Site is freeway transportation. Based on the review of municipal zoning plans, the Site is adjacent to multiple zones within Edmonton, most of which are residential (City of Edmonton 2020):

- A: Metropolitan Recreation Zone
- AGU: Urban Reserve Zone
- AN: River Valley Activity Node Zone
- AJ: Alternative Jurisdiction Zone
- AP: Public Parks Zone
- DC2: Site Specific Development Control Provision
- RA7: Low Rise Apartment Zone
- RF1: Single Detached Residential Zone
- RF5: Row Housing Zone
- US: Urban Services Zone

Most of the area surrounding the Site is developed and consists of residential areas (i.e. AJ, DC2, RA7, RF1, RF5). Other land uses include schools (AGU and US), churches (US), public parks (AP), and the recreational park area

surrounding Whitemud Creek (A). Within the recreational park area, there are multiple trails, a campground, and a ski hill named Snow Valley Ski Club. The zoning maps are provided in Appendix B.

3.3 Historical Land Use

Historical aerial photographs from 1950 and 1952 with partial coverage of the Site reveal that the Site and surrounding areas were primarily agricultural. Since at least 1952, a gravel road was present where the east-west segment of WMD is currently located. A coal mine was operated at the location of present-day Snow Valley Ski Club between 1952 and 1970. More details about historical land use is provided in Section 6.4 and Section 6.8.

4 PHYSICAL SETTING

4.1 Topography

Topography varies across the Site. At the north end, in the North Saskatchewan River valley, the elevation of Fox Drive is approximately 630 metres above sea level (masl). To the south of the WMD Fox Drive interchange, above the valley, elevation increases to approximately 660 masl and then gently slopes up to approximately 675 masl at the MWD Terwillegar Drive Interchange. East of this interchange the elevation slopes down gradually to 660 masl before dropping down to approximately 630 masl in the Whitemud Creek valley at the RVB. East of the RVB, elevation climbs back up to approximately 660 masl above the valley and slopes up gradually to approximately 665 masl at 122 Street (Natural Resources Canada 2020).

4.2 Surface Water Drainage, Nearby Receptors and Hydrogeology

Surface water drainage at the Site generally follows topography. The north portion drains towards the North Saskatchewan River, approximately 60 m north of the north Site boundary. The southwest and east portions of the Site drain into Whitemud Creek, which flows north into the North Saskatchewan River approximately 2,500 m north of the RVB (Natural Resources Canada 2020). More details about surface water drainage are available in Section 6.2.

Shallow groundwater beneath the Site is inferred to generally mimic topography, flowing north towards the North Saskatchewan River near the WMD-Fox Drive interchange, and towards Whitemud Creek throughout the rest of the Site. The inferred groundwater flow direction is a good approximation, but the actual direction would require field verification.

4.3 Soils and Vegetation

Edmonton is located in the Central Parkland Natural Subregion, which is characterized by agriculture and dense population in developed areas, and aspen and prairie vegetation in the few remaining natural areas (Natural Regions Committee 2006). Soils in the region are reported to consist of Black Chernozems in grassland regions, and dark gray Chernozems and Luvisols in aspen forest regions. However, a query of the Alberta Soil Inventory Database revealed that most soils in Edmonton consist of undifferentiated mineral soils have a disturbed profile due to urban developments (AGRASID 2020). With the exception of undeveloped portions of the North Saskatchewan River Valley and Whitemud Creek, most, if not all, soils within the Site have been disturbed due to urban development.

4.4 Surficial Geology

Surficial Geology primarily consists of glaciolacustrine deposits (i.e. sediments associated with former glacial lakes), that range from massive fine-grained sand, silt and clay for offshore sediments, to silty or pebbly sand with gravel for nearshore sediments (Fenton et al. 2013). The glaciolacustrine deposits overlie glacial till, consisting of mixed clay, silt, sand, gravel and boulders. The glaciolacustrine deposits have been eroded by Whitemud Creek and the North Saskatchewan River, and reach approximately 9 metres in thickness near Terwillegar Drive and 122 Street interchanges (Andriashek and MacMillan 1981, Kathol and McPherson 1975). Stratigraphy within the Whitemud Creek valley is bedrock at the lowest elevation, overlain by 5 to 15 metres of glacial till and approximately 5 to 10 metres of glaciolacustrine deposits at the surface.

Surficial deposits within Whitemud Creek consist of gravel, sand, silt and clay alluvium (i.e. deposited by streams), and surficial deposits within the North Saskatchewan River consists of gravel, sand and silt alluvium. Both the Whitemud Creek and North Saskatchewan River valley slopes consist of colluvial sediments (i.e. displaced by gravity) from stream alluvium, and mixed glacial and bedrock materials.

4.5 Bedrock Geology

The bedrock geology of the Site consists of sandstone interbedded with siltstones, mudstones, and coal seams of the Upper Cretaceous Horseshoe Canyon Formation (Prior et al. 2013).

4.6 Climate

The nearest climate station, University of Alberta Metabolic Centre, is located approximately 3 km northeast of the Site, at an elevation of 668 masl (ECCC 2020). This station is currently active, and climate normals data are available from 1981 to 2010. The climate in the area is characterized by cold, dry winters and warm, wet summers. Monthly average temperatures range from a minimum of -11.7 °C in January to a maximum of 17.5 °C in July. The mean annual precipitation in this region is 452.8 mm, with 370.2 mm falling as rain and the remainder falling as snow.

5 RECORDS REVIEW

5.1 Fire Insurance Plans

A query of available Fire Insurance Plans of Edmonton revealed that there are no records of buildings at the Site as of 1914 (Government of Alberta (GoC) 2020).

5.2 Drainage Records

A search request was submitted to EPCOR for records of fines or breaches of Drainage Bylaw 16200 for the Site between Terwillegar Drive and 122 Street (City of Edmonton 2019). The businesses within the search area were Snow Valley Ski Club and Rainbow Valley Campground. Several inspections were reported but no violations or issues were identified:

- On July 3, 2009, there was an inspection due to the release of grey water from an RV at the campground.
- On January 31, 2012, approximately 20 litres of hydraulic oil were spilled from a snow machine. The contaminated snow was placed in an oil water separator on site.
- In 2016, chlorine samples were collected from snow machines on four occasions between May and June.

The search results, including a map showing catch basins, drainage pipes and stormwater outfalls around RVB, are provided in Appendix C.

5.3 Aerial Photographs

Aerial photographs (AEP 2020a) were used to analyze the land use history of the Site. The analysis of aerial photographs is summarized in chronological order in Table 5-1. No additional environmental concerns were identified in the review. Aerial photographs are provided in Appendix D.

Table 5-1
Historical Aerial Photograph Analysis

Figure	Site	Surrounding Area
Figure D-1 (1950)	<p>Primarily agricultural.</p> <p>Farm at location of present day WMD-Fox Drive interchange.</p> <p>Farmsteads in location of present-day WMD-Terwillegar Drive interchange.</p> <p>East-west oriented gravel road at location of present-day WMD, which curves in the Whitemud Creek valley. A bridge crosses Whitemud Creek slightly north of present-day RVB. Structures in clearing immediately north of present-day RVB.</p> <p>Gravel Road at location of present-day 122 Street.</p>	<p>Primarily agricultural. Natural treed area surrounding Whitemud Creek.</p> <p>North: a bridge crosses Whitemud Creek approximately 30 m south of North Saskatchewan River. Clearing in trees surrounding Whitemud Creek, partially in the footprint of previous coal mine. Wet area north of present-day WMD-122 Street interchange.</p> <p>East: north-south gravel road approximately 350 m east of present-day WMD. Structures 350 m from WMD in southwest corner of section SW-24-52-25 W4M.</p> <p>South: farmstead south of present-day WMD-122 Street interchange.</p> <p>West: agriculture and farmsteads.</p>
Figure D-2 (1952)	<p>No changes observed since 1950.</p> <p>North area outside span of photograph.</p>	<p>North: outside span of photograph.</p> <p>East: no changes observed since 1950.</p> <p>South: no changes observed since 1950.</p> <p>West: no changes observed since 1950.</p>
Figure D-3 (1962)	<p>WMD has been straightened in the Whitemud Creek valley, and new bridge crosses Whitemud Creek in location of present-day RVB.</p>	<p>North: new structures in footprint of previous coal mine and northeast of present-day RVB. New farmsteads west of wet area to the north of present-day WMD-122 Street interchange.</p> <p>East: new neighbourhoods east of Whitemud Creek. New structures west of Whitemud Creek in section SW-24-52-25 W4M.</p> <p>South: no changes observed since 1952.</p> <p>West: no changes observed since 1952.</p>
Figure D-4 (1967)	<p>Trees cleared and excavation/construction work in progress at location of present-day WMD-Fox Drive interchange.</p>	<p>North: new neighbourhoods north of east-west oriented segment of WMD. Campground, grass and roads in location of former coal mine.</p> <p>East: Fox Drive under construction. Excavation between Fox Drive and North Saskatchewan River. New residences in neighbourhood east of Whitemud Creek and immediately south of Fox Drive.</p> <p>South: new neighbourhood southwest of WMD-122 Street interchange.</p> <p>West: new gravel roads and structures in location of present-day Fort Edmonton Park.</p>
Figure D-5 (1970)	<p>North-south portion of WMD under construction. Farmstead at Fox Drive interchange removed. WMD-Fox Drive overpass and bridge crossing North Saskatchewan River have been built.</p>	<p>North: new buildings in residential neighbourhoods northwest of WMD-122 Street interchange</p> <p>East: new buildings and residential neighbourhoods between WMD and Whitemud Creek.</p> <p>South: new buildings southeast of WMD-122 Street interchange.</p> <p>West: Fort Edmonton Park under construction. Residential neighbourhoods under construction.</p>
Figure D-6 (1977)	<p>WMD-Fox Drive interchange complete and in use.</p> <p>North-south portion of WMD under construction.</p> <p>New buildings within Site boundary west of 53 Avenue interchange.</p> <p>Farmsteads in southwest corner of Site removed, and WMD-Terwillegar Drive interchange under construction.</p> <p>Excavation south of WMD at location of present-day RVB.</p> <p>Snow Valley Ski Club is operational with new building and parking lot.</p> <p>WMD-122 Street interchange complete and new buildings in southeast corner of Site.</p>	<p>North: no changes observed since 1970.</p> <p>East: additional residential and commercial development in northeast corner of SE-14-52-25 W4M on 53 Street.</p> <p>South: new apartment buildings immediately southwest of WMD-122 Street interchange.</p> <p>West: new neighbourhoods, schools and parks west of WMD.</p>
Figure D-7 (1982)	<p>WMD is paved and divided throughout Site.</p> <p>Terwillegar Drive under construction.</p> <p>Two three-lane bridges at RVB are complete.</p>	<p>North: no changes observed since 1977.</p> <p>East: no changes observed since 1977.</p> <p>South: no changes observed since 1977.</p> <p>Southwest: new residential neighbourhoods adjacent to WMD-Terwillegar Drive interchange.</p> <p>West: Fort Edmonton Park continues to be developed. New neighbourhoods west of WMD.</p>
Figure D-8 (1987)	<p>WMD-Terwillegar Drive interchange with overpass is complete and in use.</p> <p>New structures in Snow Valley Ski Club and campground area.</p> <p>Changes to configuration of WMD-122 Street interchange.</p>	<p>North: no changes observed since 1982.</p> <p>East: new structures between Fox Drive and North Saskatchewan River.</p> <p>South: no changes observed since 1982.</p> <p>Southwest: new residences adjacent to WMD-Terwillegar Drive interchange.</p> <p>West: no changes observed since 1982.</p>

Figure	Site	Surrounding Area
Figure D-9 (1993)	New overpass at WMD-122 Street interchange.	North: no changes observed since 1993. East: no changes observed since 1993. Southeast: new residential neighbourhood adjacent to WMD-Terwillegar Drive interchange. South: no changes observed since 1993. West: no changes observed since 1993.
Figure D-10 (2001)	No changes observed since 1993.	North: no changes observed since 1993. East: no changes observed since 1993. Southeast: new residences adjacent to WMD-Terwillegar Drive interchange. West: new structures in Fort Edmonton Park.
Figure D-11 (2004)	No changes observed since 2001.	North: no changes observed since 2001. East: no changes observed since 2001. South: no changes observed since 2001. West: no changes observed since 2001.
Figure D-12 (2008)	No changes observed since 2004.	North: no changes observed since 2004. Northeast: new structures adjacent to WMD-Fox Drive interchange. East: new residence in location of former Shell gas station northeast corner of SE-14-52-25 W4M. South: no changes observed since 2001 West: new structures in Fort Edmonton Park.
Figure D-13 (2012)	No changes observed since 2008.	North: no changes observed since 2008. Northeast: new storm pond in location of former structures adjacent to WMD-Fox Drive interchange. East: no changes observed since 2008. South: no changes observed since 2008. West: new structure in Fort Edmonton Park.
Figure D-14 (2017)	No changes observed since 2012.	North: no changes observed since 2012. East: no changes observed since 2012. South: no changes observed since 2012. West: no changes observed since 2012.

5.4 Water Well Records

A search of the Alberta Water Well Information Database revealed nine water wells within 500 m of the Site (AEP 2020b). Water well depths range from 4.88 to 74.07 metres below ground surface (mbgs). A summary of the water wells is included in Table 5-2 below.

Table 5-2
Alberta Environment and Parks Water Wells Within 500 m of the Site

Well ID	Approximate Distance from Site	Use	Date Completed or Date Report Received
75036	100 m southwest of WMD-Fox Drive interchange	Domestic	1966-10-21
75029	Onsite – on Fox Drive immediately east of Site boundary	Unknown	1970-10-16
75087	300 m east of WMD near 143 Street	Industrial	1953-08-19
79200	100 m southeast of WMD-122 Street interchange	Domestic & stock	Unknown
2093334	Onsite – on WMD, 250 m north of WMD-Terwillegar Drive interchange	Domestic & stock	1921-08-08
2093443	500 m northwest of RVB	Industrial	1958-07-08
2093480	500 m northeast of RVB	Domestic	2019-12-31
2096405	500 m northeast of RVB	Chemistry	1962-07-01
2096482	500 m northeast of RVB	Chemistry	2014-11-13

Well ID 75029 is reported to be a spring and not a well. Well ID 75087 is reported to be a core hole with no well installed, and Well ID 2093480 is reported to be decommissioned. It is important to note that the database only provides approximate water well locations at the legal subdivision (LSD) scale of the ATS. Therefore, verification would be required to determine the location, number of wells, and their current status.

The water well search results are provided in Appendix E.

5.5 Oil and Gas Wells and Pipelines

A search of the AbaData well and pipeline database produced one pipeline and five wells within 500 m of the Site (AbaData 2020). All five wells were drilled and immediately abandoned. A summary of the oil and gas wells is provided in Table 5-3 below.

Table 5-3
Alberta Energy Regulator Wellsites Within 500 m of the Site

Well Owner / Identification	Approximate Distance from Site	Status
BP Canada Energy Group ULC W0/05-24-052-25 W4/0	Onsite – WMD-Fox Drive interchange	Abandoned January 3, 1951 – reclamation exempt
ConocoPhillips Canada Resources Corp. 100/13-13-052-25 W4/0	250 m east of WMD	Abandoned May 11, 1950 – reclamation exempt
ConocoPhillips Canada Resources Corp. 100/16-11-052-24 W4/0	Onsite – immediately east of WMD- Terwillegar Drive interchange	Abandoned May 11, 1950 – reclamation exempt
Imperial Oil Limited 1W0/04-13-052-25 W4/0	Onsite – 50 m northeast of WMD- Terwillegar interchange	Abandoned August 29, 1950 – reclamation exempt
Imperial Oil Limited 1W0/04-18-052-24 W4/0	Onsite – WMD-122 Street interchange	Abandoned August 29, 1950 – reclamation exempt

It is important to note that the database only provides approximate oil and gas well locations at the LSD scale of the ATS, and therefore precise locations cannot be verified. Four historic wells were identified onsite but, as all were “drilled and abandoned”, no oil or gas production would have occurred. Potentially contaminated drilling waste may be present near the drilling locations, however the likelihood of encountering this material is low due to previous ground disturbance associated with the construction of WMD.

There is one pipeline oriented northwest-southeast that intersects the Site in two locations Table 5-4 below summarizes the pipeline details.

Table 5-4
Alberta Energy Regulator Pipelines Within 500 m of the Site

Pipeline Owner/ Identification	Approximate Distance from Site	Substance	Status
Kinder Morgan Canada 80045-1	Onsite – intersects WMD-122 Street interchange, and WMD 450 m north of 53 Avenue	Crude oil	Operational

Oil and gas well and pipeline records are provided in Appendix F.

5.6 AER Spill Reports

The AER spill reports are records of reportable incidents throughout Alberta as required under approvals for resource facilities and installations. Based on a search of the AbaData spill and complaint database, no spills or complaints have been reported at the Site or within 500 m of the Site.

The AER spill search results are provided in Appendix G.

5.7 Coal Mine Search

The Coal Mine data repository contains records of previous and current coal mines within Alberta.

A search of this database revealed that a former coal mine (number 1727) is present at the Site (AER 2020). The mine's footprint covered the area occupied by Snow Valley Ski Club and part of the adjacent neighbourhood to the west, as well as parts of the treed and residential areas across Whitemud creek to the northeast. The mine was operated by Whitemud Creek Coal Co. Ltd. between 1952-1970 to a depth of 60.3 m and produced 248 tonnes of coal. According to the map provided in the database, the former coal mine does not intersect the Site.

Details about the coal mine are provided in Appendix H.

5.8 National Pollutant Release Inventory

Environment Canada's National Pollutant Release Inventory (NPRI) is a legislated record of pollutant releases (i.e., to air, land, and water), disposals, and transfers for recycling. It comprises information reported by facilities and published by Environment Canada as per sections 46 to 50 of the *Canadian Environmental Protection Act, 1999* (SC 1999, c. 33), as well as emission summaries and trends for key air pollutants based on facility-reported data and emission estimates for other sources, such as motor vehicles, residential heating, forest fires, and agriculture (EC 2017).

The NPRI database was searched but yielded no results within 500 m of the Site. Therefore, there is a low potential that land use activities resulting in pollutant releases have resulted in contamination of soil, soil vapour, and/or groundwater at the Site.

The NPRI search results are provided in Appendix I.

5.9 Environmental Site Assessment Repository

The ESAR is a database of sites with recorded scientific and/or technical information or sites for which an application for a reclamation certificate has been submitted to the province. A record return from an ESAR search does not imply that a site is or ever was contaminated. A query for the Site and 500 m surrounding the Site produced results at seven locations. A summary of the ESAR search results is provided in Table 5-5 below. One location was north of the North Saskatchewan River and is not included in the summary.

However, due to the distance from the Site (i.e. greater than 200 m) none of these locations are considered a significant risk for contamination of soil, soil vapour, and/or groundwater at the Site.

The ESAR search results are provided in Appendix J.

Table 5-5
ESAR Search Results

Location	Approximate Distance from Site	Details
Fort Edmonton Park	200 m west of WMD-Fox Drive interchange.	<p>In 2000, Shelby Engineering Ltd. (Shelby) conducted a Phase II ESA at the train refueling station (Shelby 2000). Soils with oil and grease impacts were identified, and it was estimated that 100 m³ of soil was contaminated.</p> <p>In 2011 Crimson Environmental Ltd. (Crimson) conducted a Phase I ESA (Crimson 2011a). The report indicated several items of concern, including the possibility off-site impacts from a refueling station, petroleum hydrocarbon (PHC) impacts along the rail line, several onsite tanks that were not registered with the PTMAA, onsite storage and use of various chemicals, the use of road salt, the use of used road sand from the city streets for onsite roads, and the potential presence of hazardous building materials.</p> <p>In 2011 and 2012, Crimson conducted limited Phase II ESAs to analyze soil beneath the rail line (Crimson 2011b and 2012). Parameters exceeding applicable guidelines included PHC, polycyclic aromatic hydrocarbons (PAH), and metals. The PHC and PAH exceedances were interpreted to indicate waste oil spills.</p> <p>In 2012, the City of Edmonton developed a Risk Management Plan (RMP) for Fort Edmonton Park Railway Operations and Maintenance for managing land and water pollution risks (City of Edmonton 2012).</p>
Riverbend Square Shopping Centre	250 m west of WMD on Riverbend Road	<p>In 1999, Morrow Environmental Consultants Inc. (Morrow) remediated and decommissioned a former Petro Canada gas station (Morrow 1999a, Alberta Environment 1999). Hydrocarbons exceeding the applicable guidelines had been identified within surrounding soil and groundwater. Contaminated soils were removed, and the area was backfilled with clean soil.</p> <p>In 2015, Pinchin Ltd. developed an RMP for the Riverbend Shopping Centre based on Phase II ESAs conducted in 2013 and 2015 (Pinchin 2015). The APECs included a dry-cleaning facility which operated from 1984 to 2005, and a retail fuel outlet in the northwest portion of the site. Parameters exceeding the applicable guidelines included polychloroethylene (PCE) and trichloroethylene (TCE) in soil, and chloroform and PCE in groundwater. The RMP included further testing and semi-annual monitoring.</p>

Location	Approximate Distance from Site	Details
Shell Riverbend service station	250 m east of WMD on 143 Street	In 1996, Komex International Ltd. (Komex) identified PHC contamination at the site during a UST decommissioning and remediation program (Komex 1996). The contaminated soil was removed and the site was backfilled with clean soil.
Terwillegar Petro Canada service station	450 m west of WMD-Terwillegar Drive interchange	<p>Between 1995 and 1999, Morrow conducted three ESAs at a former Petro Canada gas station (Morrow 1995, 1996, and 1997). Parameters exceeding applicable guidelines included benzene, toluene, ethylbenzene, xylenes (BTEX) and PHC compounds.</p> <p>In 1998, Morrow developed Site Sensitivity Assessment/Risk Management Criteria (RMC) in which Level II criteria were defined.</p> <p>In 1998, Morrow conducted a Site Decommissioning/Remediation Program wherein all petroleum facilities were removed, and contaminated soils were excavated from the site and replaced by reclaimed soil. Morrow conducted a supplemental ESA in 1999 and no parameters exceeded the Level II RMC (Morrow 1999b).</p>
Lansdowne Petro Canada service station	500 m north of WMD-122 Street interchange	<p>Between 1988 and 2005, several monitoring programs were conducted at a Petro Canada gas station by consultants (Komex 2005, Morrow 2001, 2003, and 2005, O'Connor Associates Environmental Inc. 1988 and 1990, WorleyParsons Komex 2006/2007) which included monitoring water levels and quality in monitoring wells, and vapour concentrations in boreholes and manholes surrounding the site.</p> <p>Parameters exceeding applicable guidelines included BTEX and PHC compounds. There is no available documentation post-dating 2005 that confirms whether the site has been remediated (City of Edmonton 2005).</p>
Edgeway Townhomes in Malmo Plains	450 m northeast of WMD-122 Street interchange	<p>In 2012, Thurber Engineering Ltd. (Thurber) conducted a Phase I ESA and a Limited Phase II ESA for Westcorp Properties Inc. to modify zoning at an undeveloped property previously owned by the University of Alberta (Thurber 2012a and 2012b).</p> <p>The limited Phase II ESA was initiated to identify whether contaminants were present in imported fill material, and no parameters exceeding applicable guidelines were identified. Several buildings in the Edgeway Townhomes complex have been built since 2015.</p>

5.10 City of Edmonton Records

A search request was submitted to the City of Edmonton for environmental reports on the Site. One of the search results indicated a spill in the Rainbow Valley Bridge area, and the report was reviewed.

In October 2016, Nichols Environmental (Canada) Ltd. (Nichols) was retained by the City of Edmonton to complete a Spill Response and Remediation Program for a spill (Nichols 2016). A gravel truck struck a bucket lift truck and caught fire on the westbound lanes of WMD on October 5, 2016. The fire was extinguished with an unknown volume of firefighting foam which, along with diesel fuel released from the gravel truck, flowed on the WMD surface and through a drainage culvert on the north Rainbow Valley Bridge into a seepage pit below. It is possible that the firefighting foam contained Per and Polyfluoroalkyl Substances (PFAS) chemicals such as Perfluorooctanoic Acid (PFOA). Within the parkland area below the bridge, the seepage pit overflowed, and impacted water migrated toward Whitemud Creek. Initial response included soil and surface water sampling on October 6, 2016, and excavation of contaminated material began on October 7, 2016.

A total of 38 soil samples (Resp-01, Resp-02, and SA-01 through SA-36) were collected between the initial spill response on October 6, 2016, during excavation on October 7, 2016, and the completion of remedial activities on October 21, 2016. Based on field screening results for organic soil vapours, 11 soil samples were selected for laboratory analysis of BTEX, PHC Fractions 1 through 4 and PAHs. Nichols compared soil analytical results to the 2016 Alberta Tier 1 Soil and Groundwater Remediation (AT1) Guidelines for Natural Area Land Use (AEP 2016).

Table 5-6
Soil Parameters Exceeding Guidelines in Nichols 2016 Report

Sampling Date	# Samples Analyzed	Parameters Analyzed	Parameters Exceeding 2016 AT1 Guidelines
October 6, 2016	1	BTEX PHC fractions F1-F4 PAH	Sample ID: Resp-01 BTEX PHC fractions F1-F3 PAH: acenaphthene, fluoranthene, fluorene, naphthalene, phenanthrene, and pyrene
October 7, 2016	6	BTEX PHC fractions F1-F4 PAH	Sample ID: SA-01 PAH: anthracene, fluoranthene, pyrene
			Sample ID: SA-22 PAH: anthracene, fluoranthene, naphthalene, phenanthrene, pyrene
			Sample ID: SA-23 PAH: naphthalene
October 21, 2016	4	PAH	NA

Associated compared the laboratory results to 2019 AT1 Guidelines and did not identify any additional exceedances (AEP 2019).

Two surface water samples were collected on October 6 and 7, 2016 and tested in a laboratory for BTEX and PHC Fractions 1 through 3+ and PAHs. Nichols compared water analytical results to the 2014 Environmental Quality

Guidelines for Alberta Surface Waters using the aquatic life pathway, and all parameters were below applicable guidelines.

By October 21, 2016, remedial excavation was completed and approximately 152 tonnes of impacted soil were disposed at a landfill. The soil closure samples contained PAH concentrations below applicable guidelines. However, it is important to note that the samples were not tested for PFAS and PFOA, which are commonly found in firefighting foam.

Nichols' report and an email from a City of Edmonton representative regarding the spill response is provided in Appendix K.

5.11 Petroleum Tank Management Associated of Alberta

The PTMAA database is a record of aboveground and underground storage tanks that are registered in the province of Alberta or that were inventoried during a survey of abandoned sites completed in 1992. While this database is incomplete, a search for pertinent information is still worthwhile. PTMAA searches are conducted by individual property, and therefore 13204-Rainbow Valley Road NW was selected, which is the location of Snow Valley Ski Club and former coal mine. A query of the PTMAA database for 13204-Rainbow Valley Road NW revealed that no tanks have been inventoried at the property (PTMAA 2020).

The search results are provided in Appendix L.

5.12 Environmental Law Centre Records

The Environmental Law Centre Historical Search Service database provides a list of enforcement actions under EPEA and its predecessor legislation against a company or an individual. No Environmental Law search was conducted as part of this limited Phase I ESA as there have been no known businesses or companies that have occupied the Site.

5.13 Freedom of Information and Protection of Privacy

Online FOIP applications are submitted to the GoA by property. No FOIP application was submitted as part of this limited Phase I ESA due to the size of the Site and as this assessment is intended for conceptual planning.

5.14 Landfill Searches

The H.E.L.P. (Help End Landfill Pollution) data tracking and management control system tracked industrial landfills in Alberta (GoA 1988). Information gathered on Industrial landfills during the program until 1988 has been summarized in a single file. A search of the H.E.L.P. database did not reveal any industrial landfills within 500 m of the Site.

No Alberta Health Services request was submitted as part of this limited Phase I ESA as this assessment is intended for conceptual planning and the Site is developed.

6 SITE INSPECTION

Associated's Danielle Loiselle G.I.T., Environmental Scientist, conducted the site inspection on April 22, 2020. The weather was approximately 12°C and overcast. The ground was predominantly dry, however scarce pockets of snow remained in shaded areas.

The Site photographs are in Appendix M.

6.1 Buildings

No buildings were inspected during the Site visit.

6.2 Grounds

6.2.1 General Description

The Site spans 4.9 km of WMD from the WMD-Fox Drive interchange to the WMD-122 Street interchange. The north-south segment of WMD within the Site connects Fox Drive and Terwillegar Drive and, above the North Saskatchewan River valley, is relatively flat and includes the WMD-53 Avenue interchange. The east-west segment of WMD connects the WMD-Terwillegar Drive interchange to the WMD-122 Street interchange and follows topography, sloping toward Whitemud Creek and RVB.

Natural topography along the north-south segment of WMD is inferred to be relatively flat, however the ground has been built up to accommodate overpass systems at the interchanges with Fox Drive, 53 Avenue, and Terwillegar Drive. The east-west segment slopes towards Whitemud Creek and has been built up to accommodate the RVB.

The WMD-Fox Drive interchange is a partial clover leaf overpass system surrounded by grassy slopes and trees. The interchange is bordered by the North Saskatchewan River to the north, a wet storm water pond to the northeast, a pasture with horses to the southeast, and Fort Edmonton Park to the west (Photographs 1 and 2). Natural topography is inferred to slope gently to the north towards the North Saskatchewan River.

Further south is the 53 Avenue bridge and overpass system with grassy slopes and some trees (Photograph 3). The overpass is bordered by a park to the northeast, the Edmonton Alberta Temple and the Church of Jesus Christ Latter-day Saints to the southeast, residence to the southwest, and a school and park to the northwest.

The WMD-Terwillegar Drive interchange is a partial clover leaf overpass system surrounded by grassy slopes, treed areas, and residential properties (Photographs 4 and 5). Northeast of Terwillegar Drive and west of 142 Street, numerous saplings have been planted in the open area.

Whitemud Drive slopes towards the Whitemud Creek valley and the RVB, which are two identical bridges accommodating eastbound and westbound traffic (Photographs 6, 7 and 8). Rainbow Valley Road crosses Whitemud Creek north of RVB, and provides vehicle access to Snow Valley Ski Club, Rainbow Valley Campground, Snow Valley Aerial Park, and several gravel parking lots. Snow Valley Ski Club is northwest of RVB and includes two chairlifts and a lodge.

The east boundary of the Site is the WMD-122 Street interchange, which consists of an overpass system and is surrounded by grassy slopes and residential areas (Photograph 9).

6.2.2 Surface Water

Surface water is present in the wet storm water pond northwest of the WMD-Fox-Drive interchange, which mitigates flooding during heavy rainstorms (Photograph 1). Whitemud Creek flows north below RVB and drains into the North Saskatchewan River (Photograph 8). During the site visit, water in the creek was turbid and flowing rapidly.

Throughout the Site, surface water drains into catch basins along WMD, or directly into natural water bodies in vegetated areas surrounding Whitemud Creek and North Saskatchewan River. Culverts direct water from overpasses and bridges to lower ground. Below RVB and along Rainbow Valley Road, evidence of soil erosion was observed in several locations. It is inferred that boulders were placed in these areas to prevent further erosion (Photographs 6 and 8).

6.2.3 Wells

No wells (water, oil, or gas) were observed.

6.2.4 Storage Tanks and Process Vessels

No storage tanks were observed.

6.2.5 Waste and Sewage Disposal

Waste and recycling bins were noted south of the Snow Valley Ski Club lodge, and a trash can was present in the gravel parking lot south of RVB. No sewage or septic tanks were observed.

6.2.6 Vegetation

Vegetation throughout the Site was predominantly reflective of seasonal norms. Saplings were planted in the open area northeast of Terwillegar Drive and west of 142 Street, and south of WMD between Terwillegar Drive and RVB. In several locations along the curb of WMD, there were patches without grass (Photograph 4).

6.2.7 Fill

Fill material was not directly observed on the Site.

6.2.8 Debris

Scattered debris was present throughout the Site, primarily in vegetated areas surrounding WMD (Photographs 1, 2, 5, and 6). The debris included coffee cups, wrappers, plastic bags, and miscellaneous scraps of building materials such as wood and fiberglass insulation.

6.2.9 Staining

Salt staining was observed along the curb of WMD in several locations, including beneath the 53 Avenue overpass (Photograph 3), the Terwillegar Drive interchange (Photograph 4), and beneath the 122 Street overpass (Photograph 9).

6.2.10 Parking Facilities

Three gravel parking lots were observed near Whitemud Creek. One was adjacent to Snow Valley Ski Club, another was immediately north of RVB, and the final was southeast of RVB.

6.2.11 Rights-of-way

Utility boxes were observed throughout the Site, and some locations had utility marking flags. Given the importance of the freeway and that there are many structures surrounding WMD, it is likely that numerous utility rights-of-way are present along neighbouring properties.

7 INDICATIONS OF ENVIRONMENTAL RISK

The potential for soil, vapour, and/or groundwater at the Site to be contaminated depends on past and current land use(s) at the Site. Neighbouring properties can also pose environmental risk based on their current and past land uses, and on their distance and relative position to the site with respect to groundwater flow gradient. Up-gradient sites are generally associated with higher risk because of the potential for groundwater transport of contaminants to down-gradient locations.

7.1 Site

Based on the results of the Limited Phase I ESA, there is high potential¹ that current or past land use activities at the Site have resulted in contamination of soil, vapour, and/or groundwater. Based on visual observations, it is likely that salt contamination is present adjacent to roadways from winter road salt application. As WMD is a high-traffic area, debris was found throughout the Site but is not considered a significant contamination risk. Both debris and salt could be transported to natural water bodies through the drainage network.

The location of the October 2016 diesel spill and fire is considered an area of potential environmental concern (APEC) (APEC 1). An unknown volume of firefighting foam was released which may contain PFAS and PFOA. These substances are emerging contaminants of concern and were not assessed during the 2016 remediation activities.

Figure 2 provides the location of APEC 1.

7.2 Neighbouring Properties

Based on the results of the Limited Phase I ESA, there is low potential that current or past land use activities at neighbouring properties have resulted in contamination of soil, vapour, and/or groundwater at the Site. No APECs were identified in properties neighbouring the Site.

¹ High potential – there is either physical or visual/olfactory evidence or very recent factual evidence of contamination on site.
Moderate potential – there is evidence of past or current land uses or infrastructure with potential to release contaminant(s) into the environment.
Low potential – there is little to no evidence of sources of contamination.

8 CONCLUSIONS AND RECOMMENDATIONS

A limited Phase I ESA was completed along a 4.9 km segment of Whitemud Drive in Edmonton, Alberta which spans from the WMD-Fox Drive interchange to the WMD-122 Street interchange.

Based on the results of the Limited Phase I ESA, there is high potential that current or past land use activities at the Site have resulted in contamination of soil, vapour, and/or groundwater. Two APECs were identified at the Site:

- APEC 1: Diesel spill area near RVB where sampling for PFAS substances related to firefighting foam was not completed.
- APEC 2: Salt staining present along Whitemud Drive throughout the Site.

There is low potential that current or past land use activities at neighbouring properties have resulted in contamination of soil, vapour, and/or groundwater at the Site. No APECs were identified in properties neighbouring the Site.

Associated provides the following recommendations:

- Where present, all debris should be removed from the Site prior to any excavation work;
- Soils within or adjacent to APEC 1 should be assessed prior to construction or earthworks for potential contaminants of concern (PCOCs) that may require management;
- Soils adjacent to WMD that are to be disturbed during future construction/expansion should be assessed for PCOCs that may need to be managed;
- Any soils encountered during ground disturbance with indications of potential contamination such as odours, staining, or sheen should be assessed for PCOCs and may need to be managed.
- Should excavation surrounding Whitemud Creek occur below stream elevation, temporary re-routing of the stream and dewatering of the excavation may be required.

CLOSURE

This report was prepared for the City of Edmonton to identify areas of potential environmental concern along the 4.9 km segment of Whitemud Drive between Fox Drive and 122 Street.

The services provided by Associated Engineering Alberta Ltd. in the preparation of this report were conducted in a manner consistent with the level of skill ordinarily exercised by members of the profession currently practicing under similar conditions. No other warranty expressed or implied is made.

Respectfully submitted,
Associated Engineering Alberta Ltd.

Prepared by:

Reviewed by:



Danielle Loiselle, G.I.T.
Environmental Scientist



28-Aug-2020

Brent Schmidt, P.Geo
Geoscientist

PERMIT TO PRACTICE	
ASSOCIATED ENVIRONMENTAL CONSULTANTS INC.	
RM SIGNATURE:	
RM APEGA ID #:	200901
DATE:	August 28, 2020
PERMIT NUMBER: P009919	
The Association of Professional Engineers and Geoscientists of Alberta (APEGA)	

REFERENCES

- Abacus Datagraphics (Abadata). 2020. Available online at: <http://www.abacusdatagraphics.com/>
- Agricultural Regions of Alberta Soil Inventory Database (AGRASID). 2020. Alberta Soil Information Viewer. Available online at: <https://soil.agric.gov.ab.ca/agrasidviewer/>
- Alberta Energy Regulator (AER). 2020. AER Coal Mine Map Viewer. Available online at: <https://extmapviewer.aer.ca/AERCoalMine/Index.html>
- Alberta Environment. 1999. Site decommissioning/Remediation Program. Former Petro-Canada Riverbend Gas Bar Facility. 5697 Riverbend Road, Edmonton Alberta.
- Alberta Environment and Parks (AEP). 2016. Alberta Tier 1 Soil and Groundwater Remediation Guidelines. Land and Forestry Policy Branch, Policy Division. Available online at: <https://open.alberta.ca/dataset/842becf6-dc0c-4cc7-8b29-e3f383133ddc/resource/1b851705-0622-485d-beee-752a627bdfc4/download/2016-albertatier1guidelines-feb02-2016a.pdf>
- Alberta Environment and Parks (AEP). 2019. Alberta Tier 1 Soil and Groundwater Remediation Guidelines Land Policy Branch, Policy and Planning Division. Available online at: <https://open.alberta.ca/dataset/842becf6-dc0c-4cc7-8b29-e3f383133ddc/resource/a5cd84a6-5675-4e5b-94b8-0a36887c588b/download/albertatier1guidelines-jan10-2019.pdf>
- Alberta Environment and Parks (AEP). 2020a. Alberta Air Photo Distribution. Available online at: <https://securexnet.env.gov.ab.ca/aprs/index.html>
- Alberta Environment and Parks (AEP). 2020b. Alberta Water Well Information Database. Available online at: <http://aep.alberta.ca/water/reports-data/alberta-water-well-information-database/default.aspx>
- Alberta Geological Survey (AGS). 2015. Available online at: <http://www.ags.gov.ab.ca/>
- Andriashek, L.D. MacMillan, R.A. 1981. Preliminary Report on the Urban Geology of the Annexed areas in Edmonton. Available online at: https://ags.aer.ca/publications/OFR_1982_01.html
- Canadian Standards Association (CSA). 2016. CSA Standard Z768-01 (2016) – Phase I Environmental Site Assessment.
- City of Edmonton. 2005. Summary of Site Monitoring Activities, City of Edmonton Road Allowance Adjacent to Lansdowne Petro-Canada, 5110-122 Street. Edmonton.
- City of Edmonton. March 2016. Environmental Site Assessment Guidebook.
- City of Edmonton. 2019. Bylaw 18093 – Drainage Bylaw (Formerly Bylaw 16200).

City of Edmonton. 2012. Risk Management Plan. Fort Edmonton Park Railway Operations & Maintenance for managing land and water pollution risks.

City of Edmonton. 2020. Zoning Bylaw 12800. Available online at https://www.edmonton.ca/city_government/bylaws/zoning-bylaw.aspx

Crimson Environmental Limited (Crimson). 2011a. Phase I Environmental Site Assessment. Fort Edmonton Park. 7000-143 Street NW. Plan 8521469, Block A, Edmonton Alberta.

Crimson Environmental Limited (Crimson). 2011b. Limited Phase II Environmental Site Assessment. Fort Edmonton Park. 7000-143 Street NW. Plan 8521469, Block A, Edmonton Alberta.

Crimson Environmental Limited (Crimson). 2012. Limited Phase II Environmental Site Assessment. Fort Edmonton Park. 7000-143 Street NW. Plan 8521469, Block A, Edmonton Alberta.

Environment Canada (EC). 2017. National Pollutant Release Inventory (NPRI). Available online at: <https://www.canada.ca/en/services/environment/pollution-waste-management/national-pollutant-release-inventory.html>

Environment and Climate Change Canada (ECCC). 2020. Canadian Climate Normals. Available online at: http://climate.weather.gc.ca/climate_normals/index_e.html

Fenton, M.M. Waters, E.J. Pawley, S.M. Atkinson, N. Utting, D.J. McKay, K. 2013. *Surficial Geology of Alberta*. Alberta Energy Regulator, ARE/AGS Map 601, Scale 1:1,000,000.

Government of Alberta (GoA). 1988. H.E.L.P. Help End Landfill Pollution: data tracking & management control system. Available online at: <https://open.alberta.ca/publications/1560566#summary>

Government of Canada (GoC). 2020. Insurance plan of Edmonton, Alberta, Volume 1, May 1913, revised August 1914. Available online at: http://collectionscanada.gc.ca/pam_archives/index.php?fuseaction=genitem.displayEcopies&lang=eng&rec_nbr=3806261&title=Insurance%20plan%20of%20Edmonton,%20Alberta,%20Volume%201,%20May%201913,%20revised%20August%201914.&ecopy=e010674836-v8

Kathol, C.P. McPherson, R.A. 1975. Urban Geology of Edmonton. Available online at: https://ags.aer.ca/publications/BUL_032.html

Komex International Ltd. 1996. Underground Storage Tank Removal and Soil Remediation Program Shell Riverbend Service Station (#C01773) Edmonton, Alberta.

Komex International Ltd. 2005. Summary of Site Monitoring Activities. City of Edmonton Road Allowance Property, 51st Avenue and 122nd Street, Edmonton, Alberta.

Morrow Environmental Consultants Inc. 1995. Petro Canada Terwillegar Service Station. 45th Avenue and Riverbend Road, Edmonton, Alberta. Location 36679. Environmental Assessment.

- Morrow Environmental Consultants Inc. 1996. Supplemental Environmental Assessment - Terwillegar Mall Former Petro-Canada Service Station, Location Code 36679, 45th Avenue and Riverbend Road, Edmonton, Alberta.
- Morrow Environmental Consultants Inc. 1997. Supplemental Environmental Assessment - Terwillegar Mall Former Petro-Canada Service Station, Location Code 36679, 45th Avenue and Riverbend Road, Edmonton, Alberta.
https://ags.aer.ca/publications/BUL_032.htmlhttps://ags.aer.ca/publications/BUL_032.html
- Morrow Environmental Consultants Inc. 1998. Tank Removal and Site Remediation Program. Former Petro-Canada Riverbend Gas Bar Facility. 5697 Riverbend Road, Edmonton Alberta.
https://ags.aer.ca/publications/BUL_032.html
- Morrow Environmental Consultants Inc. 1999a. Site decommissioning/Remediation Program. Former Petro-Canada Riverbend Gas Bar Facility. 5697 Riverbend Road, Edmonton Alberta.
- Morrow Environmental Consultants Inc. 1999b. Supplemental Environmental Assessment – Former Terwillegar Gas Bar, 14904-45th Avenue, Edmonton, Alberta. Location No. 36679
- Morrow Environmental Consultants Inc. 2001. Environmental Assessment Activities – Petro-Canada Lansdowne Gas Bar (02669), 5110-122nd Street, Edmonton, Alberta.
- Morrow Environmental Consultants Inc. 2003. Environmental Assessment Activities – Petro-Canada Lansdowne Gas, 5110-122nd Street, Edmonton, Alberta.
- Morrow Environmental Consultants Inc. 2005. Environmental Assessment Activities – Petro-Canada Lansdowne Gas, 5110-122nd Street, Edmonton, Alberta.
- Natural Resources Canada. 2020. The Atlas of Canada – Toporama. Available online at:
<https://atlas.gc.ca/toporama/en/index.html>
- Natural Subregions Committee. 2006. Natural Regions and Subregions of Alberta. Compiled by D.J. Downing and W.W. Pettapiece. Government of Alberta. Pub. No. T/852. Available online at:
https://www.albertaparks.ca/media/2942026/nrsrcomplete_may_06.pdf
- Nichols Environmental (Canada) Ltd. 2016. Spill Response and Remediation Program – Rainbow Valley Road Beneath Whitemud Drive 14-12-052-25-W4M, Edmonton, Alberta.
- O'Connor Associated Environmental Inc. 1988. Monitoring and Remediation Activities – Lansdowne Service Station, Edmonton, Alberta.
- O'Connor Associated Environmental Inc. 1990. Monitoring and Remediation Activities – Lansdowne Service Station, Edmonton, Alberta.
- Pinchin Ltd. 2015. Risk Management Plan, 5603-5689 Riverbend Road, Edmonton, Alberta.



Prior, G.J. Hathaway, B. Glombick, O.M. Pana, D.I. Banks, C.J. Hay, D.C. Schneider, C.L. Grobe, M. Elgr, R. Weiss, J.A. 2013. Bedrock Geology of Alberta. Alberta Energy Regulator, AER/AGS Map 600, Scale 1:1,000,000.

Shelby Engineering Ltd. 2000. Phase II Environmental Site Assessment, Train Refueling Station, Fort Edmonton Park, Edmonton, Alberta.

Thurber Engineering Ltd. 2012a. Addendum No. 1 – Regulatory Agencies Response – Phase I Environmental Site Assessment. 11730-51 Avenue NW, Edmonton, Alberta.

Thurber Engineering Ltd. 2012b. Addendum No. 1 – Limited Phase II Environmental Site Assessment. 11730-51 Avenue NW, Edmonton, Alberta.

WorleyParsons Komex. 2006/2007. Site Monitoring Report. Lansdowne Gas Bar. 5110-122nd Street, Edmonton, Alberta. Location No. 02669.

APPENDIX A – SITE FIGURES

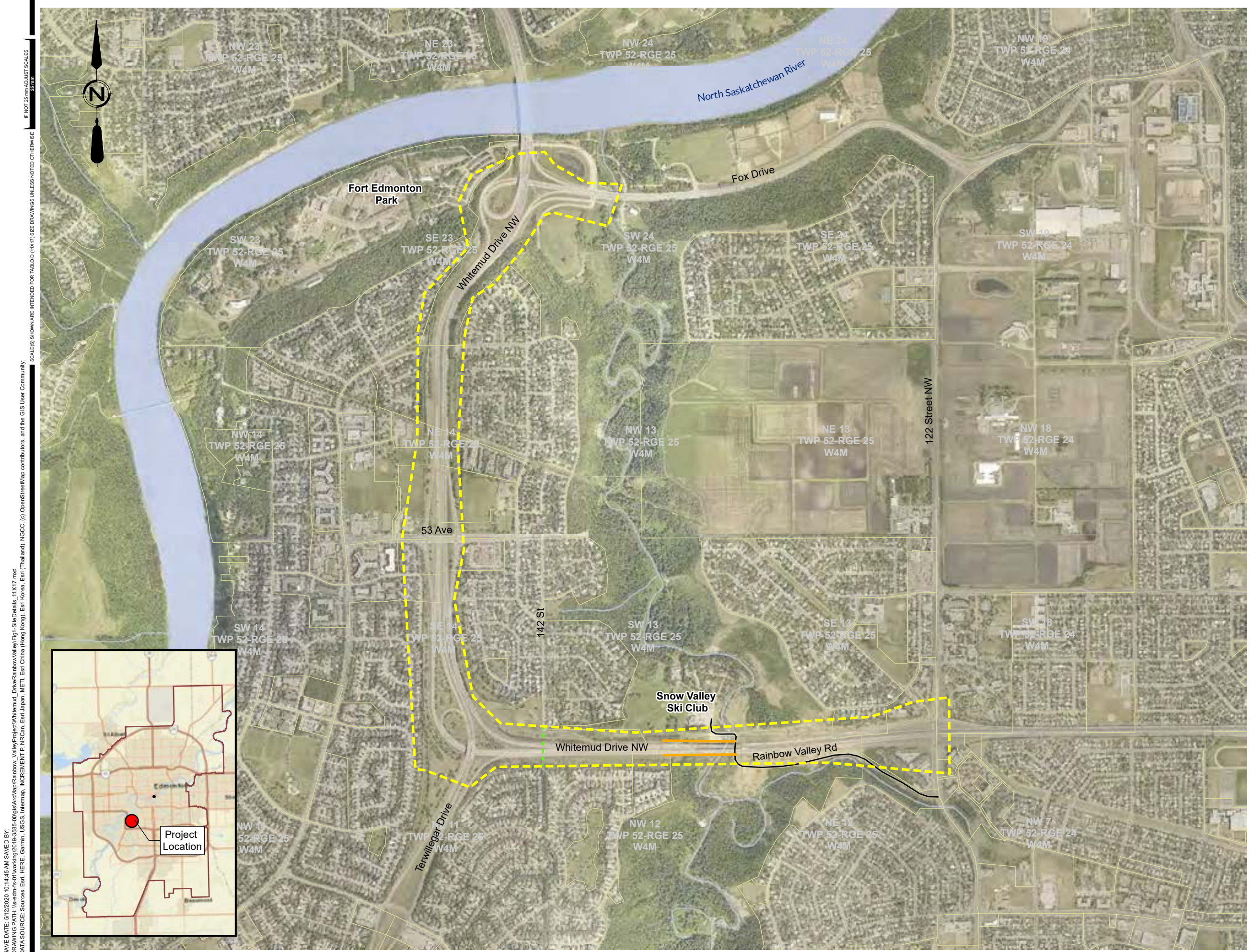

Legend

- Rainbow Valley Bridges
- Rainbow Valley Road
- Future Pedestrian/Cyclist Bridge
- Site Boundary
- North Saskatchewan River Valley and Ravine System
- Water Body

FIGURE 1
RAINBOW VALLEY BRIDGES RENEWAL
AND WIDENING

SITE DETAILS

AE PROJECT No.	2019-3585
SCALE	1:15,000
APPROVED DATE	2020MAY12
REV DESCRIPTION	ISSUED FOR REPORT

SAVE DATE: 5/12/2020 10:14:45 AM SAVED BY: [unreadable]
 DRAWING PATH: [unreadable]
 DATA SOURCE: Esri, HERE, Garmin, USGS, Intermap, INCREMENT P, NRCan, Esri Japan, METI, Esri China (Hong Kong), Esri Korea, Esri (Thailand), NGCC, (c) OpenStreetMap contributors, and the GIS User Community
 SCALE(S) SHOWN ARE INTENDED FOR TABLOID (11X17) SIZE DRAWINGS UNLESS NOTED OTHERWISE
 IF NOT 25 mm AS SHOWN SCALES

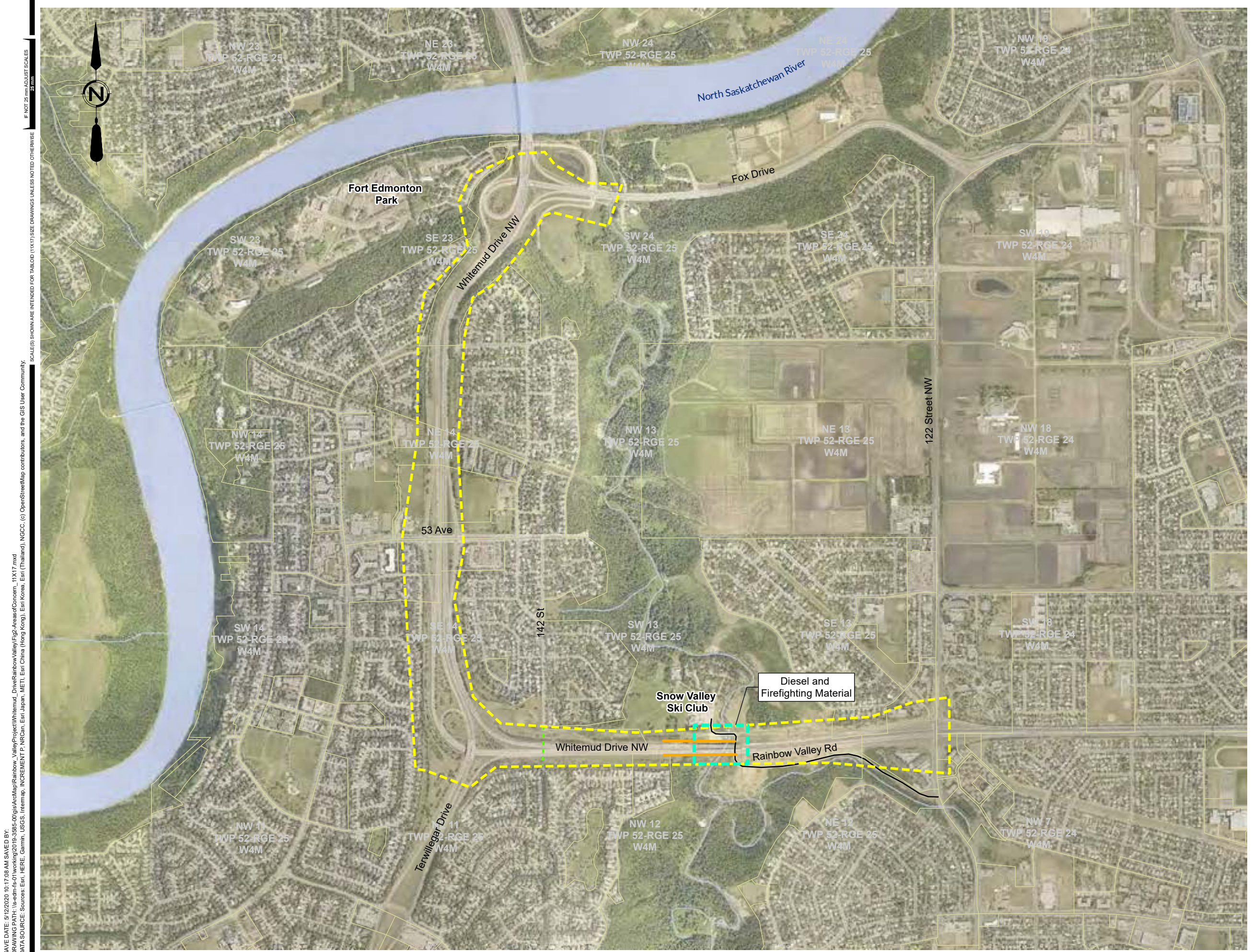

Legend

- Rainbow Valley Bridges
- Rainbow Valley Road
- Future Pedestrian/Cyclist Bridge
- Site Boundary
- Area of Potential Environmental Concern
- North Saskatchewan River Valley and Ravine System
- Water Body

FIGURE 2
 RAINBOW VALLEY BRIDGES RENEWAL
 AND WIDENING

AREA OF ENVIRONMENTAL CONCERN

AE PROJECT No.	2019-3585
SCALE	1:15,000
APPROVED DATE	2020MAY12
REV DESCRIPTION	ISSUED FOR REPORT

SAVE DATE: 8/12/2020 10:17:08 AM SAVED BY: [unreadable]
 DRAWING PATH: [unreadable]
 DATA SOURCE: Sources: Esri, HERE, Garmin, USGS, Intermap, INCREMENT P, NRCan, Esri Japan, METI, Esri China (Hong Kong), Esri Korea, Esri (Thailand), NGCC, (c) OpenStreetMap contributors, and the GIS User Community
 SCALE(S) SHOWN ARE INTENDED FOR TABLOID (11X17) SIZE DRAWINGS UNLESS NOTED OTHERWISE.

APPENDIX B – MUNICIPAL LAND PLANS

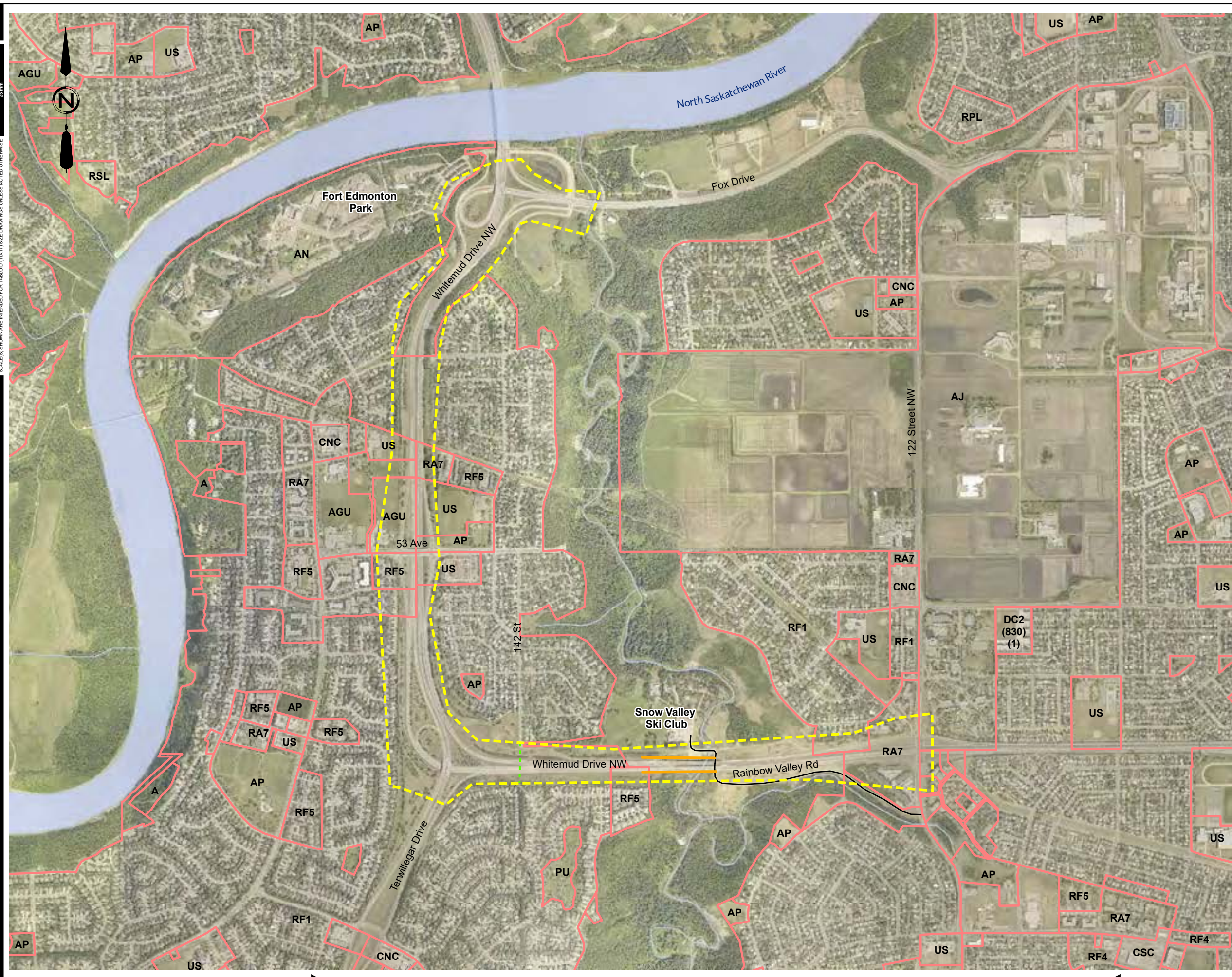

Legend

- Rainbow Valley Bridges
- Rainbow Valley Road
- - - Future Pedestrian/Cyclist Bridge
- Site Boundary
- Zoning Bylaw
- North Saskatchewan River Valley and Ravine System
- Water Body

Zoning	Description
A	Metropolitan Recreation
AGU	Urban Reserve
AJ	Alternative Jurisdiction
AN	River Valley Activity Node
AP	Public Parks
CNC	Neighbourhood Convenience Commercial
CS3	Community Services 3
CSC	Shopping Centre
DC2	Site Specific Development Control Provision
PU	Public Utility
RA7	Low Rise Apartment
RF1	Single Detached Residential
RF4	Semi-Detached Residential
RF5	Row Housing
RPL	Planned Lot Residential
RR	Rural Residential
RSL	Residential Small Lot
US	Urban Services

FIGURE B-1
 RAINBOW VALLEY BRIDGES RENEWAL AND WIDENING
 CITY OF EDMONTON ZONING

AE PROJECT No. 2019-3585
SCALE 1:15,000
APPROVED DATE 2020MAY12
REV DESCRIPTION ISSUED FOR REPORT

SAVE DATE: 8/12/2020 12:10:47 PM SAVED BY: [Name]
 DRAWING PATH: [Path]
 DATA SOURCE: [Sources]

IF NOT 25 mm AS SHOWN SCALES
 SCALES(S) SHOWN ARE INTENDED FOR TABLORD (11X17) SIZE DRAWINGS UNLESS NOTED OTHERWISE

APPENDIX C - DRAINAGE RECORDS



9504 – 49 Street NW
Edmonton, Alberta
T6B 2M9 Canada
epcor.com

May 6, 2020

Application No: 361539844-001
Customer File: 2019-3585

DANIELLE LOISELLE, G.I.T.
ENVIRONMENTAL SCIENTIST
ASSOCIATED ENVIRONMENTAL CONSULTANTS INC.
500, 9888 – JASPER AVENUE NW
EDMONTON AB. T5J 5C6

Re: Legal Address: W4M-25-52-12 AND W4M-25-52-13
Municipal Address: WHITEMUD DRIVE BETWEEN TERWILLEGAR AND 122 STREET NW, AB

Attached are the results of a record search for the above noted premises with respect to compliance with City of Edmonton Sewers Use Bylaws, Sewers Bylaws, Drainage Bylaws, EPCOR Drainage Services Bylaw and EPCOR Water Services and Wastewater Treatment Bylaws. Inquiries with respect to this search should be directed to the undersigned at (780) 509-8067. You will be invoiced for this service at a later date.

Regards,

A handwritten signature in blue ink that reads "D Johnston". The signature is written in a cursive, flowing style.

Dave Johnston
Team Lead - Industrial Source Control
Drainage Services

Enclosure



9504 – 49 Street NW
 Edmonton, Alberta
 T6B 2M9 Canada
 epcor.com

DRAINAGE SERVICES RECORD SEARCH

THIS SEARCH COVERS RECORDS RELATED TO THE FOLLOWING SECTIONS OF CITY BYLAWS: CITY OF EDMONTON SEWERS BYLAW # 9425, Sections 4-38, SEWERS USE BYLAW # 9675, Sections 4-37, DRAINAGE BYLAW # 16200, Sections 4-40, 50-51, DRAINAGE BYLAW # 18093 Sections 15-20, EPCOR DRAINAGE SERVICES BYLAW # 18100, Schedule 2 and EPCOR WATER SERVICES AND WASTEWATER TREATMENT BYLAW # 17698, Schedule 1, Part IV, Wastewater Overstrength Surcharges.

CUSTOMER: ASSOCIATED ENVIRONMENTAL CONSULTANTS INC.

CUSTOMER FILE #: 2019-3585 **DATE RECEIVED:** MAY 4, 2020

APPLICATION #: 361539844-001

PROPERTY DETAIL:

MUNICIPAL ADDRESS: WHITEMUD DRIVE BETWEEN TERWILLEGAR AND 122 STREET NW, AB

LEGAL ADDRESS / DESCRIPTION: W4M-25-52-12 AND W4M-25-52-13

NAME OF FACILITY: SNOW VALLEY SKI CLUB/RAINBOW VALLEY CAMPGROUND

TYPE OF BUSINESS: RECREATION FACILITIES

- NOT INSPECTED / NO RECORDS FOUND
- INSPECTED - DATE OF INSPECTION: SEE ATTACHED
- NO VIOLATION(S) FOUND
- VIOLATION(S) FOUND: _____
- NOTICE TO COMPLY ISSUED: _____
- FINE(S) ISSUED: _____
- OVERSTRENGTH SURCHARGES LEVIED: _____

COMMENTS: _____

This Records Search is provided in accordance with City of Edmonton Bylaw 18100, EPCOR Drainage Services Bylaw. While EPCOR strives to provide complete and accurate information, no warranties, promises or guarantees are made about the accuracy, completeness or adequacy of this Records Search.

SEARCH BY:	<u>Helena Reynolds</u>	DATE:	<u>May 6, 2020</u>
REVIEWED BY:	<u>Dave Johnston</u>	DATE:	<u>May 6, 2020</u>



9504 – 49 Street NW
Edmonton, Alberta
T6B 2M9 Canada
epcor.com

Our record search of the premises located at WHITEMUD DRIVE BETWEEN TERWILLEGAR AND 122 STREET NW, AB (W4M-25-52-12 AND W4M-25-52-13) revealed the following information:

Address: 13204 – 45 Avenue
Known As: Rainbow Valley Campground
Details: Campground

July 3, 2009 Inspection due to release of grey water from RV Disposal location which was reported late. No sign of release during inspection. No issues.

Address: 13204 - 45 Avenue
Known As: Snow Valley Ski Club
Details: Ski Club

January 31, 2012 Release of approximately 20L of hydraulic oil from snow machine. Contaminated snow from clean-up placed in oil water separators on site. No issue.

Address: 13204 – 45 Avenue
Known As: Snow Valley Ski Club
Details: Ski Club

February 19, 2013 Routine Inspection of food establishment. No violations found.

Address: 13204 – 45 Avenue
Known As: Snow Valley Ski Club
Details: Ski Club

May 10, 2016 Collect chlorine sample from snow machine-not going to sewer system.
May 17, 2016 Deliver sample results.
May 25, 2016 Collect chlorine samples from snow machine-not going to sewer system.
June 23, 2016 Collect chlorine samples from snow machine-not going to sewer system.



9504 – 49 Street NW
 Edmonton, Alberta
 T6B 2M9 Canada
epcor.com

Manhole (MH) and Catch Basin (CB) on Whitemud Drive between Terwillegar Drive and 122 Street

CB305230 No Records	CB305223 No Records	CB330589 No Records	MH303917 No Records
MH303932 No Records	MH303921 No Records	MH303915 No Records	CB305220 No Records
MH303933 No Records	MH303922 No Records	MH303916 No Records	CB305221 No Records
MH303934 No Records	MH303924 No Records	MH305219 No Records	MH303918 No Records
MH210983 No Records	MH211044 No Records	MH211037 No Records	CB305222 No Records
MH303935 No Records	CB305224 No Records	CB305164 No Records	MH303919 No Records
MH303936 No Records	MH211042 No Records	CB305163 No Records	MH303915 No Records
CB305231 No Records	CB305213 No Records	CB305166 No Records	MH303910 No Records
MH303912 No Records	MH211041 No Records	CB305165 No Records	CB305162 No Records
CB305210 No Records	MH303914 No Records	MH305209 No Records	MH211032 No Records
MH211033 No Records	MH211036 No Records	MH211031 No Records	CB305211 No Records
MH303913 No Records	MH211040 No Records	CB305161 No Records	MH211034 No Records
CB305214 No Records	CB305217 No Records	MH303911 No Records	CB305212 No Records
CB305216 No Records	MH211028 No Records	MH211027 No Records	MH303908 No Records
MH211025 No Records	MH303904 No Records	CB305197 No Records	CB305198 No Records
Facility 211035 (Outfall #2) No Records	CB305202 No Records	CB305205 No Records	CB305199 No Records
MH303905 No Records	MH211024 No Records	MH211026 No Records	MH303907 No Records
MH303909 No Records	CB305207 No Records	CB305200 No Records	MH303906 No Records
CB305206 No Records	CB305201 No Records	CB305203 No Records	CB305158 No Records
MH211030 No Records	CB305204 No Records	CB305160 No Records	CB305208 No Records
CB305159 No Records	MH303903 No Records	MH211020 No Records	CB529084 No Records
Facility 303880 Outfall #4 No Records	Facility 211021 Outfall #3A No Records	MH208879 No Records	MH303879 No Records
CB329082 No Records	MH529079 No Records	MH208880 No Records	MH313976 No Records
MH208801 No Records	MH211022 No Records	CB530554 No Records	CB209275 No Records
MH208898 and CB209277 October 10, 2016 Diesel spill in both manhole and catch basin, both cleaned out. MH and CB located on the West side of Whitemud Bridge above Whitemud Creek	CB209257 No Records	MH208896 No Records	MH313975 No Records
CB209271 No Records	CB209274 No Records	CB209258 No Records	CB209276 No Records
CB209256 No Records	CB209278 No Records	MH208876 No Records	MH211013 No Records
MH208875 No Records	MH209272 No Records	MH208895 No Records	MH208874 No Records



9504 – 49 Street NW
Edmonton, Alberta
T6B 2M9 Canada
epcor.com

MH208894 No Records	CB209276 No Records	MH208899 No Records	MH313977 No Records
MH208877 No Records	MH208878 No Records	CB209265 No Records	CB209269 No Records
MH208901 No Records	MH208888 No Records	CB209268 No Records	CB330604 No Records
MH208892 No Records	MH208891 No Records	MH208873 No Records	CB209255 No Records
CB209267 No Records	CB209266 No Records	MH313973 No Records	MH208872 No Records
CB209270 No Records	MH208889 No Records	MH208890 No Records	MH208871 No Records
MH313974 No Records	MH208893 No Records		

The screenshot displays the POSSE software interface. On the left, there is an 'Address Expansion Search' panel with search criteria: 'Return: Titled lot, Entryways', 'House Number: 13204', and 'Street: 45 AVE'. Below this is a list of search results with columns for 'Description' and 'Address'. The main window shows details for '13204 - 45 AVENUE NW' with 'Plan 4002MC Lot R (Title(s): 108Y191)'. A 'Tax Roll Owner' popup window is open, displaying the following information:

- Tax Roll Owner:: CITY OF EDMONTON ...**
- First Name: [Empty field]
- Last Name/Company: CITY OF EDMONTON CIT
- Formatted Address: BOX 2359 EDMONTON AB T5J 2R7
- Tax Roll Number: 7992076
- Buttons: OK, Cancel

Locate

I'm looking for Address Lookup

House Number:

Unit (optional):

Street or Avenue Name:
45 AVENUE NW

Popular: To show assessment values on the map [click here](#)

New: To show address labels on the map [click here](#)

[Help](#) [Data Refresh List](#) [Contact Us](#)

Results	
Address	General Assessment Applications Nearby Applications Nearby Addresses
The address '13204 - 45 AVENUE NW' found at 1 lot	
13204 - 45 AVENUE NW	<p>Address: 13204 - 45 AVENUE NW</p> <p>Legal Description for Title Lot: Lot R, Block , Plan 4002MC</p> <p>Area: 351,720.444 m²</p> <p>Year Built:</p> <p>Neighbourhood: Whitemud Creek Ravine North</p> <p>Ward: Ward 10</p> <p>Waste Collection: Thursday More Information</p> <p>Current Zone: Metropolitan Recreation Zone (A)</p> <p>Current Bylaw: 12800</p> <p>Proposed Applications: None</p> <p>Proposed Zone: None</p>
<p>Show: Selected Only</p> <p><input type="button" value="Fit List"/></p>	

Search for Address or Inter



CB209275

MH208896

CB209256

MH208875

MH208876

CB209276

MH208897

MH313976

MH313977

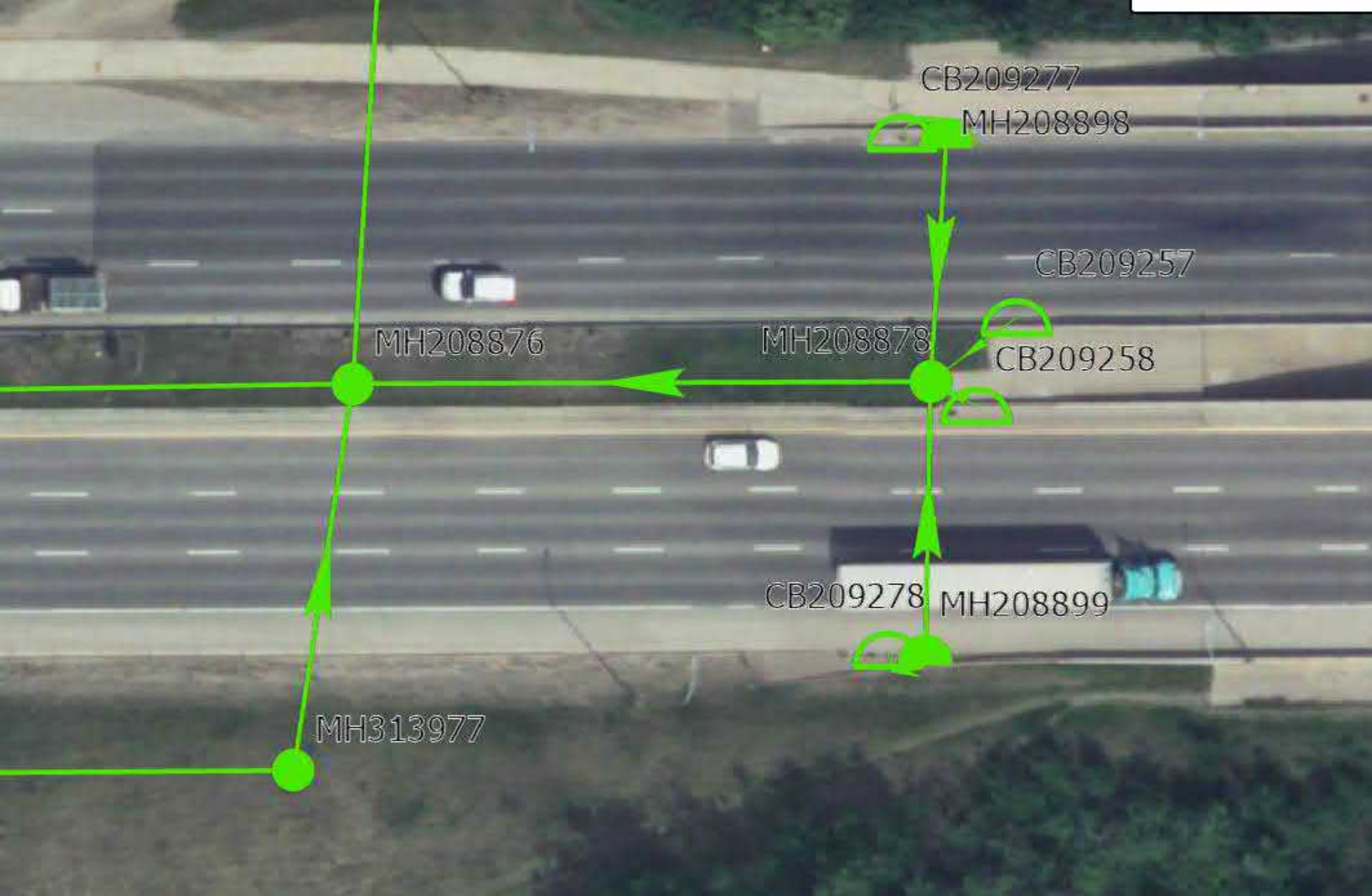

CB209277

MH208898

CB209257

MH208876

MH208878

CB209258

CB209278

MH208899

MH313977

MH208877

MH208879

MH208880

CB209277

MH208898



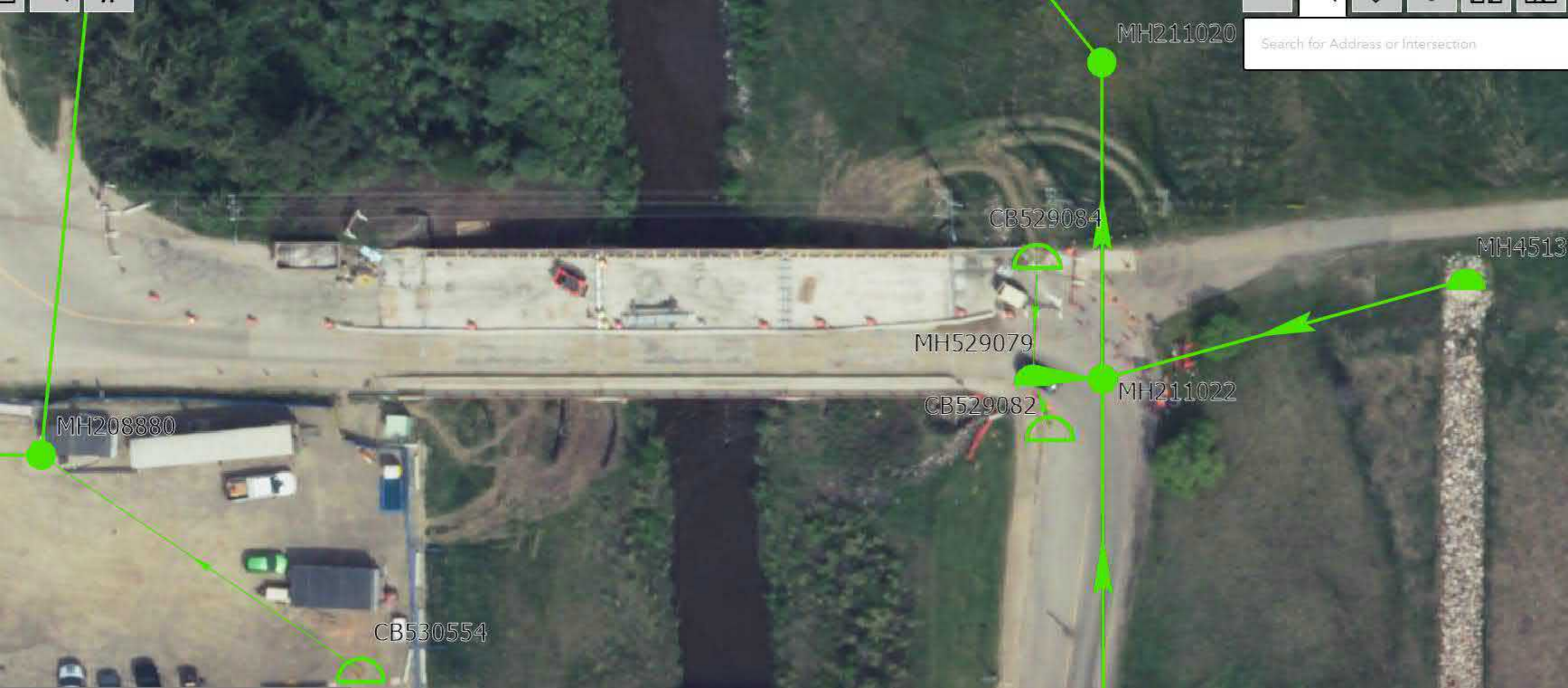

Search for Address or Intersection

MH211020

CB529084

MH4513

MH529079

MH211022

CB529082

MH208880

CB530554

MH208801

OF3

OF3A



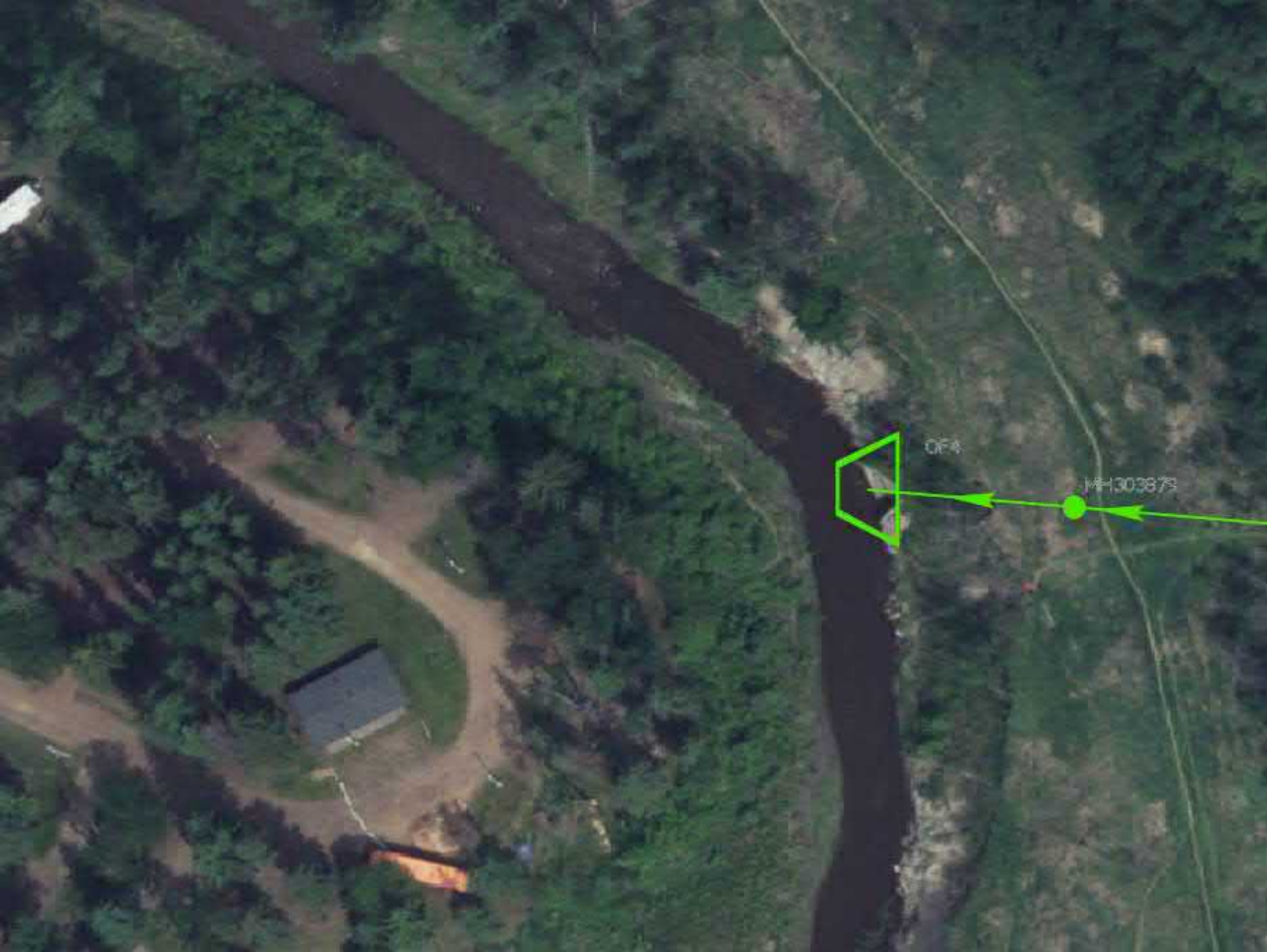

OF 4

MH1303875

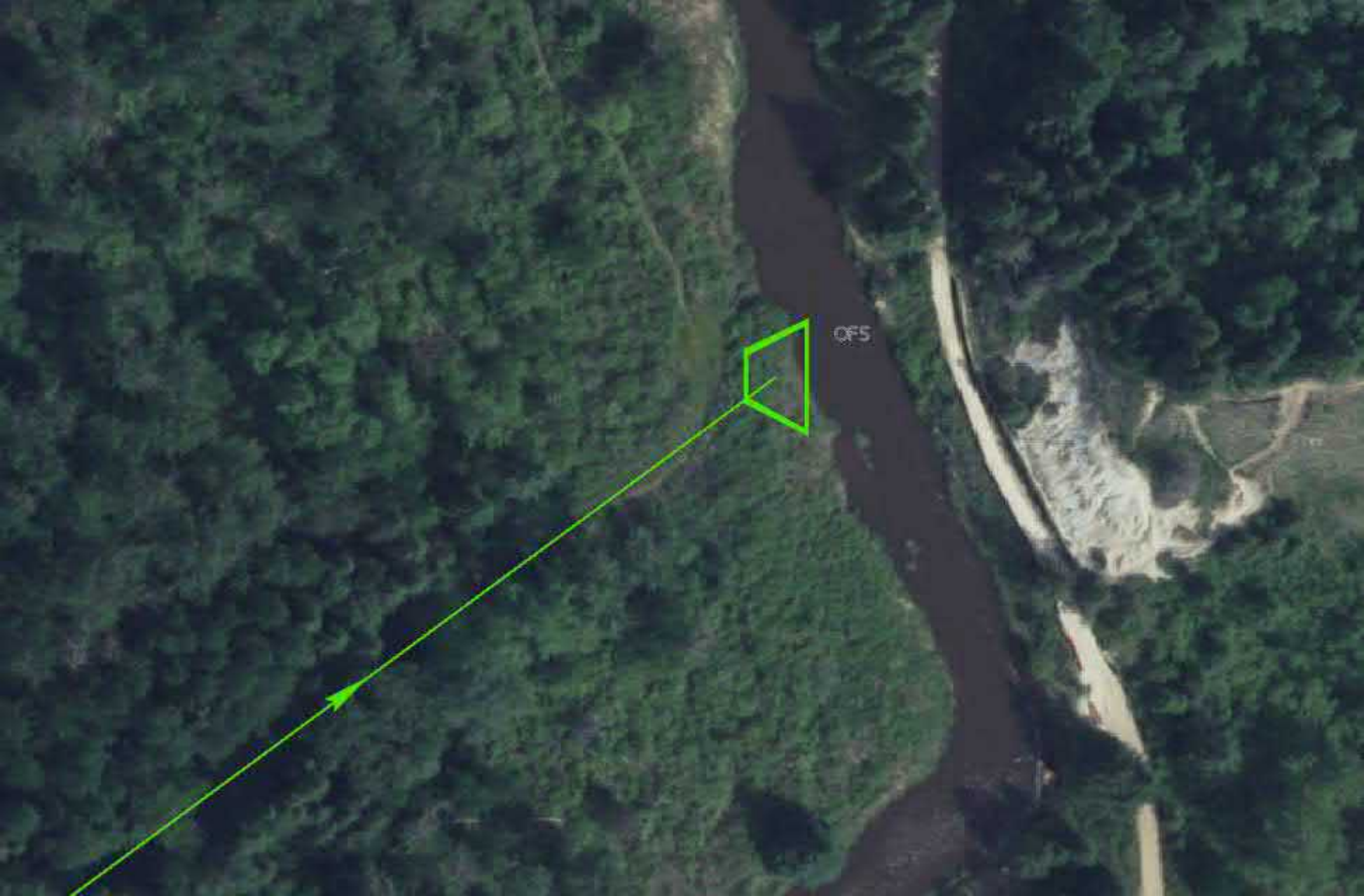

QF5

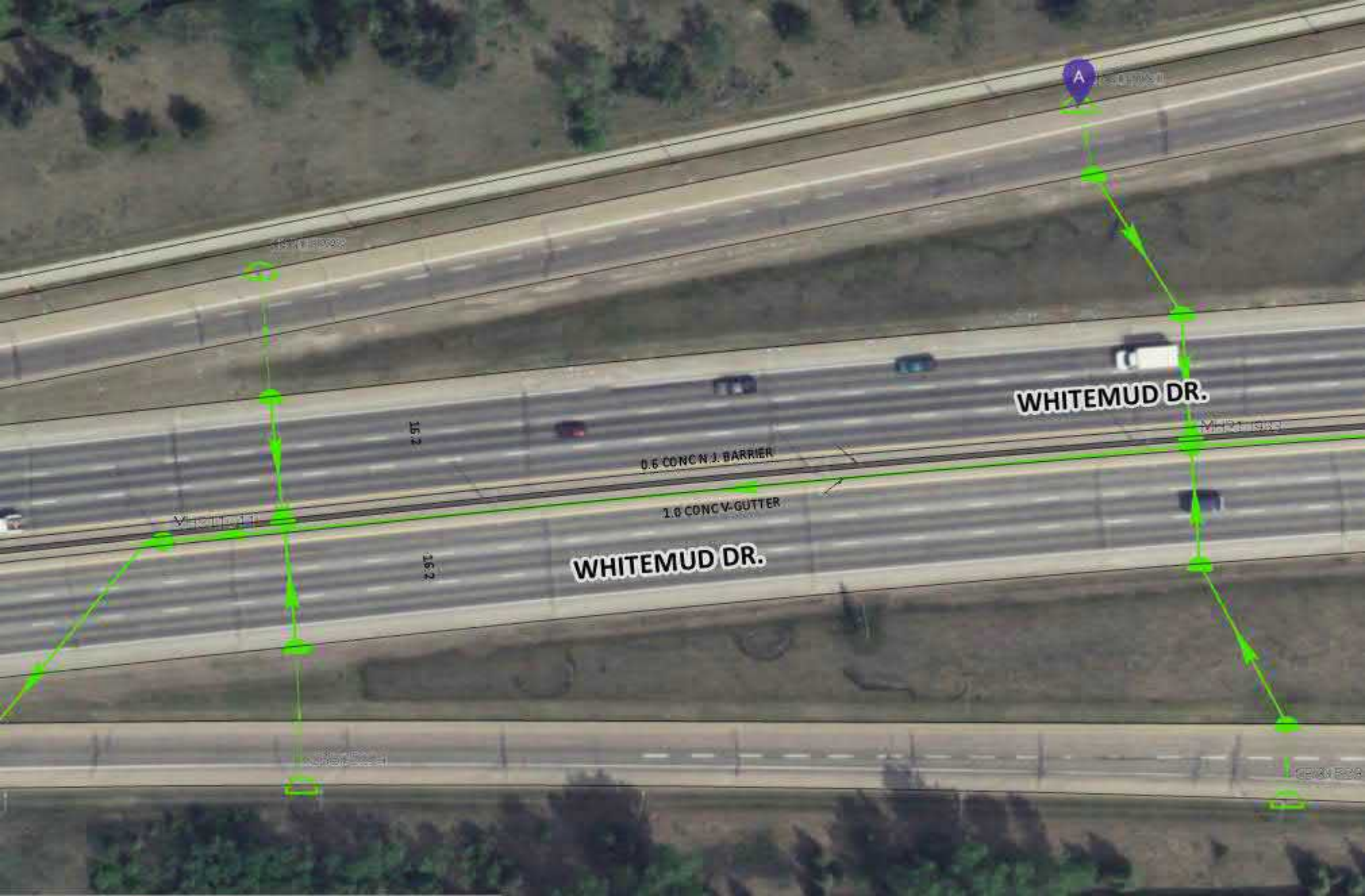

WHITEMUD DR.

WHITEMUD DR.

0.6 CONC N.J. BARRIER

1.0 CONC V-GUTTER

15.2

16.2

A

MHP

MHP

© 2014 MHP

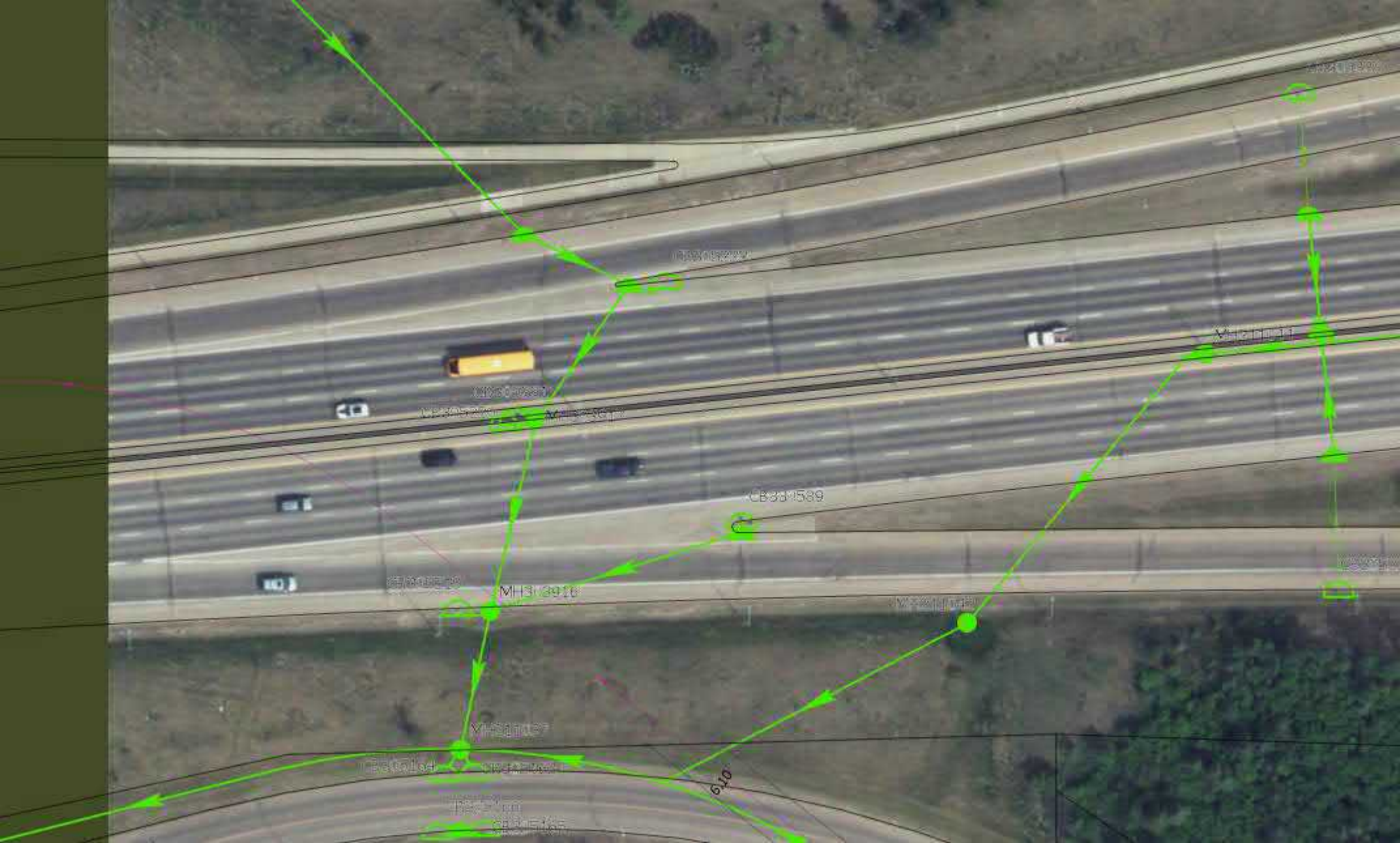

CB3405270

MH3000880

CB3405272

CB3405270

MH3000880

CB3405279

CB3405271

CB3405272

MH3000880

CB3405278

MH3000880

CB3405270

CB3405270

CB3405270

610

CB3405279

CB3405279

CB3405279



MH211031

CB205101

MH211032

CB303101

MH211033

Whitemud Park

CB303111

CB303111

MH211034

CB303111

MH211035

CB303111

6.10

6.10

7.9

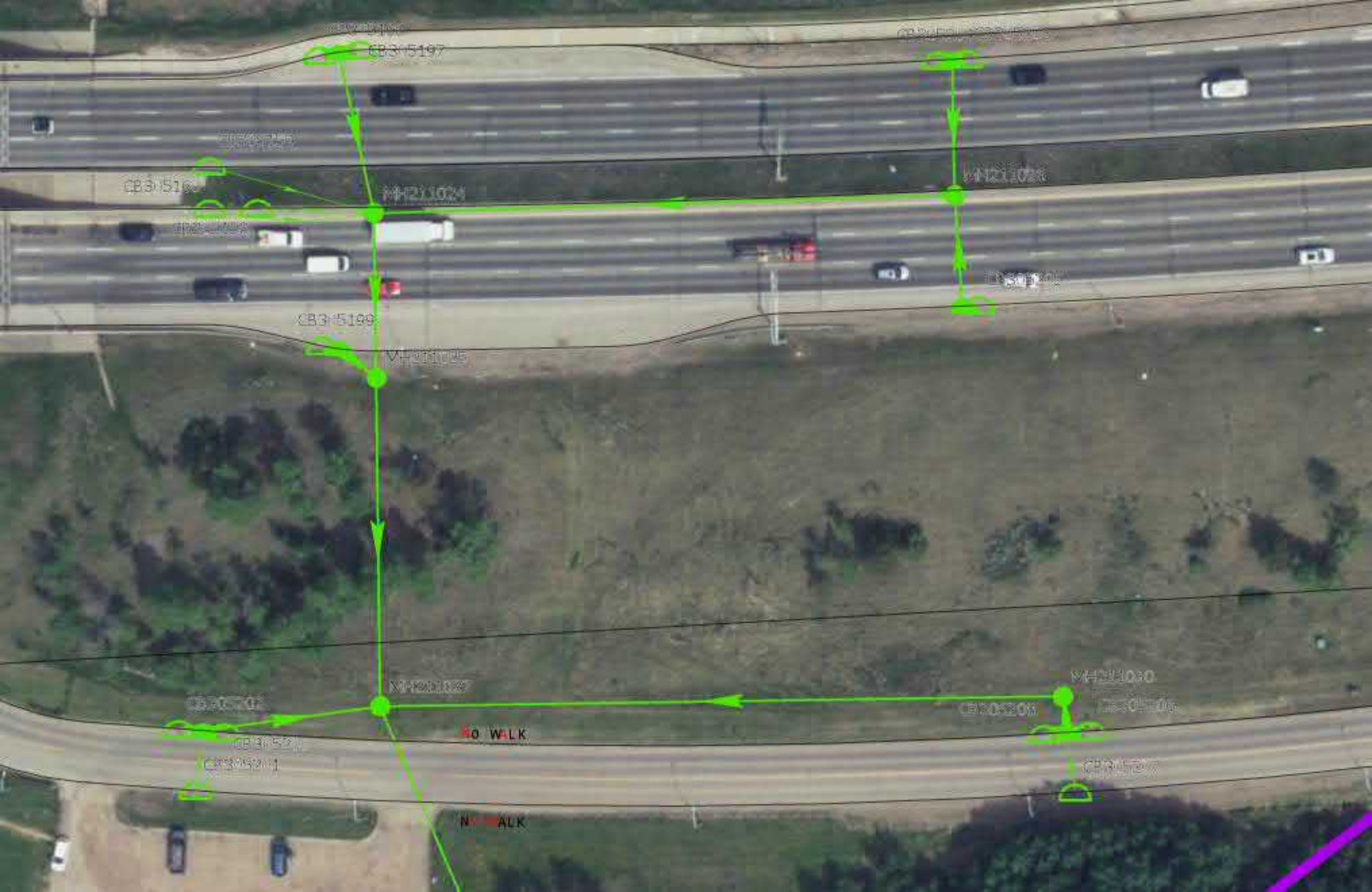



HC211028

CP2

APPENDIX D - AERIAL PHOTOGRAPHS

IF NOT 25 mm ADJUST SCALES
25 mm

SCALE(S) SHOWN ARE INTENDED FOR LETTER (8.5x11) SIZE DRAWINGS UNLESS NOTED OTHERWISE

THIS DRAWING IS FOR THE USE OF THE CLIENT AND PROJECT INDICATED - NO REPRESENTATIONS OF ANY KIND ARE MADE TO OTHER PARTIES

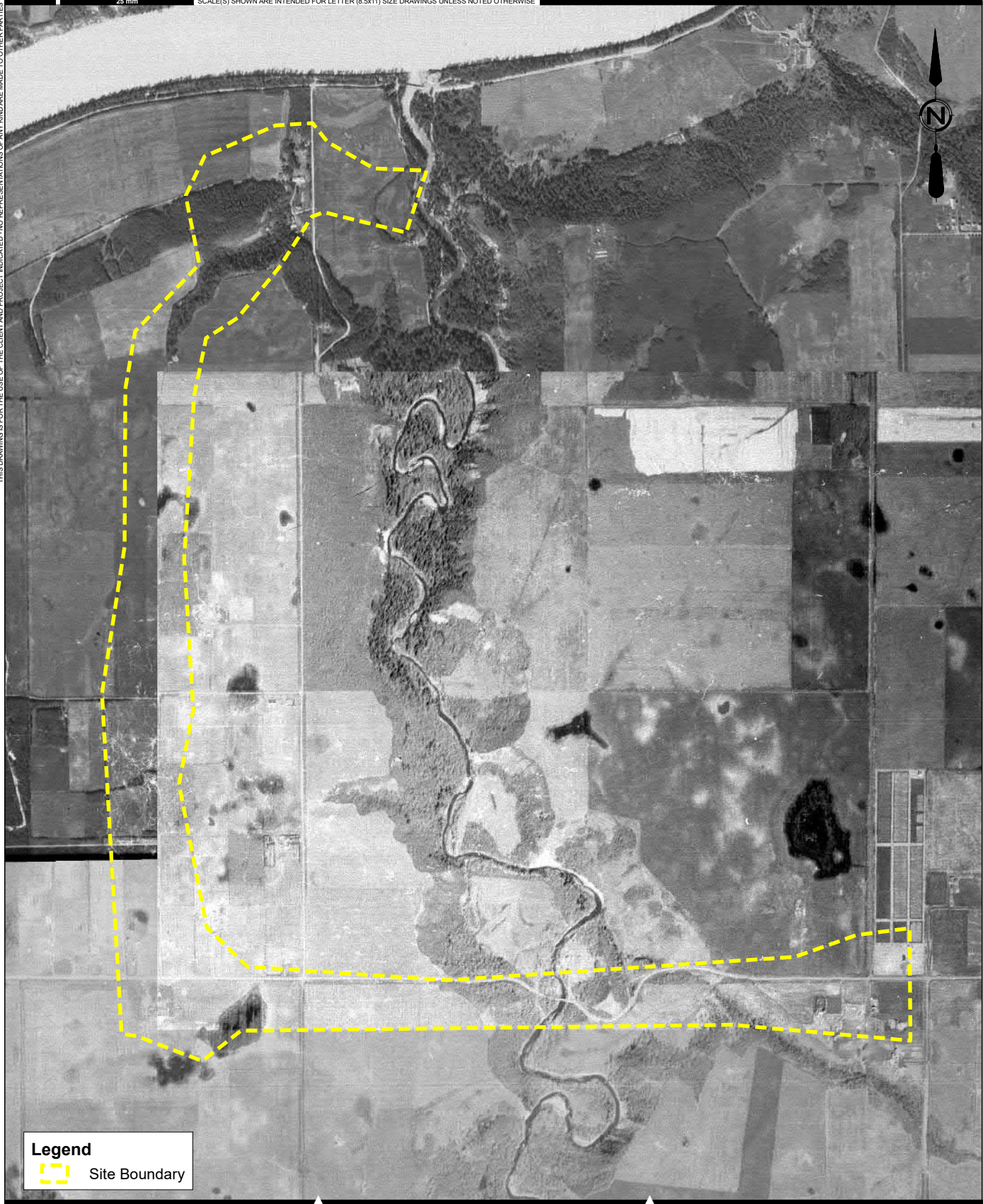

\\cedm-fs-01\working\2019-3585-00\gis\ArcMap\Rainbow_ValleyProject\Whitemud_DriveRainbowValley\FigD_HistoricalPhotos.mxd
DATE: 5/12/2020

Legend
[Yellow dashed line symbol] Site Boundary





AE PROJECT No. 2019-3585
DATE 2020 MAY
SCALE 1:15,000
COORD. SYSTEM NAD 1983 CSRS 3TM 114
REV
DESCRIPTION ISSUED FOR REPORT

FIGURE No. D-1
RAINBOW VALLEY BRIDGES RENEWAL AND WIDENING

1950 AERIAL PHOTO

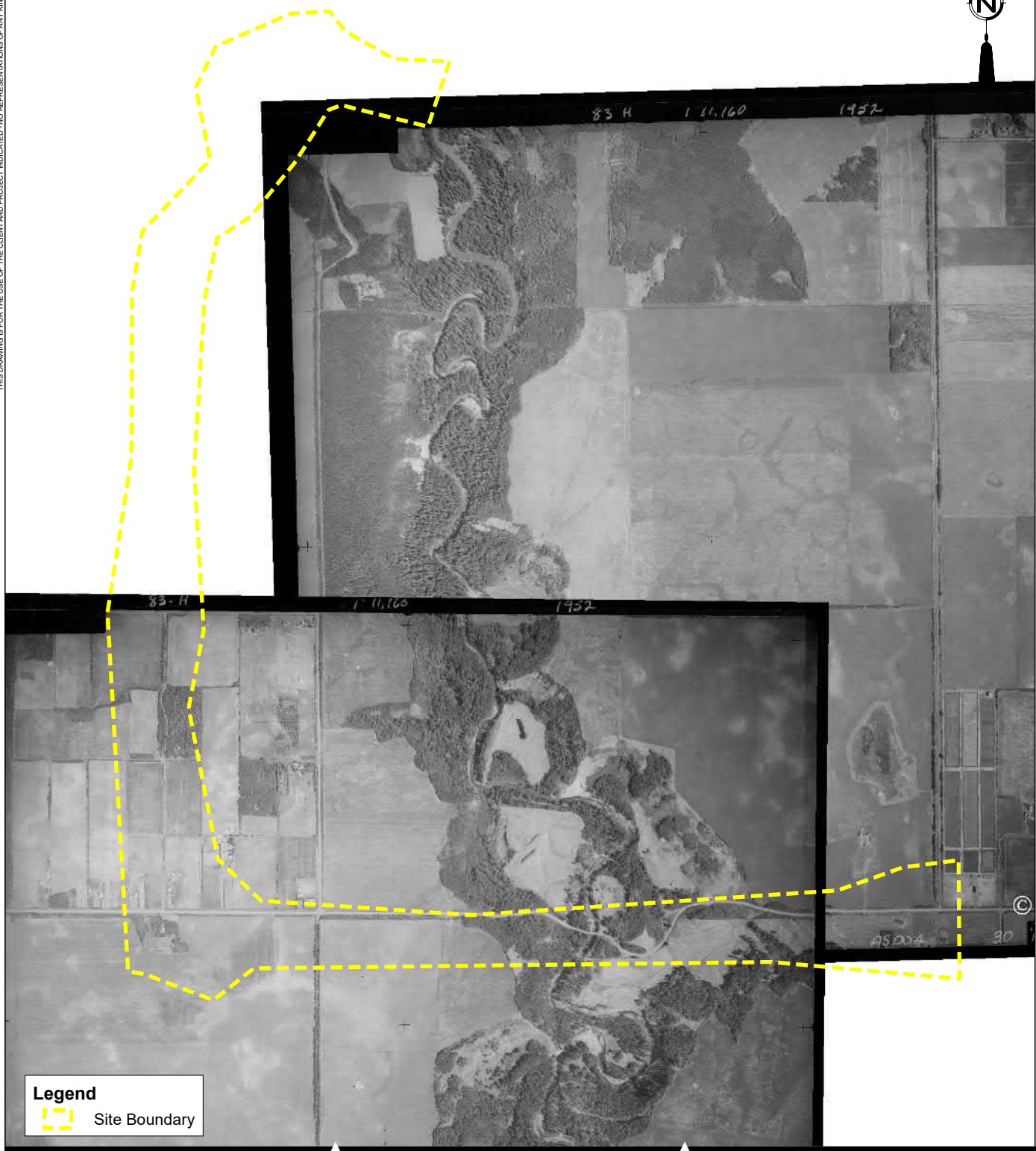
THIS DRAWING IS FOR THE USE OF THE CLIENT AND PROJECT INDICATED - NO REPRESENTATIONS OF ANY KIND ARE MADE TO OTHER PARTIES



Legend
 Site Boundary

\\cedm-fs-01\working\2019-3585-00\gis\ArcMap\Rainbow_Valley\Project\Whitemud_Drive\RainbowValley\FigD_HistoricalPhotos.mxd
DATE: 5/12/2020



AE PROJECT No. 2019-3585
DATE 2020 MAY
SCALE 1:15,000
COORD. SYSTEM NAD 1983 CSRS 3TM 114
REV
DESCRIPTION ISSUED FOR REPORT

FIGURE No. D-2
RAINBOW VALLEY BRIDGES RENEWAL AND WIDENING
 1952 AERIAL PHOTO

IF NOT 25 mm ADJUST SCALES
25 mm

SCALE(S) SHOWN ARE INTENDED FOR LETTER (8.5x11) SIZE DRAWINGS UNLESS NOTED OTHERWISE

THIS DRAWING IS FOR THE USE OF THE CLIENT AND PROJECT INDICATED - NO REPRESENTATIONS OF ANY KIND ARE MADE TO OTHER PARTIES

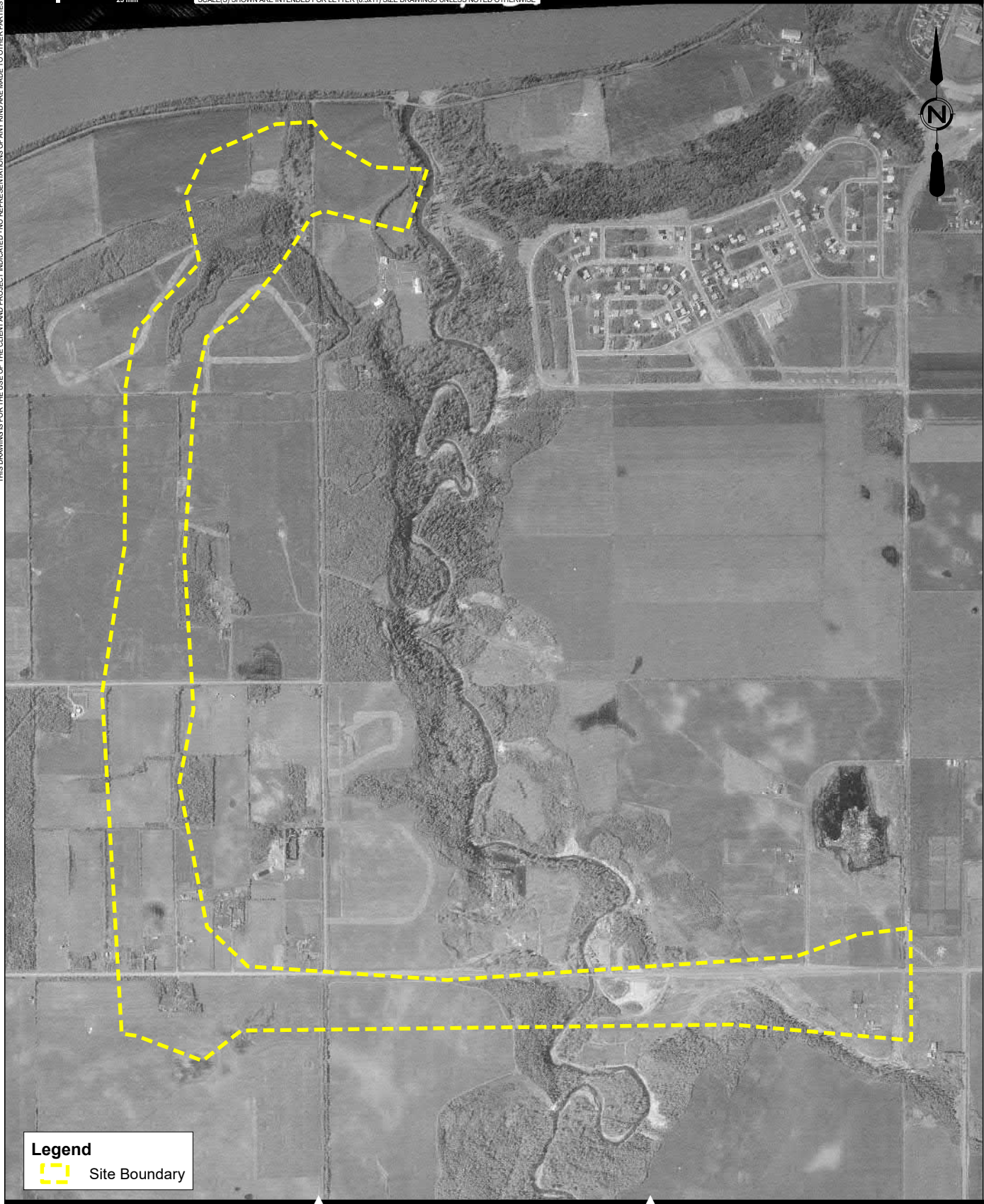

\\cedm-fs-01\working\2019-3585-00\gis\ArcMap\Rainbow_ValleyProject\Whitemud_DriveRainbowValley\FigD_HistoricalPhotos.mxd
DATE: 5/12/2020

Legend
 Site Boundary



AE PROJECT No. 2019-3585
DATE 2020 MAY
SCALE 1:15,000
COORD. SYSTEM NAD 1983 CSRS 3TM 114
REV
DESCRIPTION ISSUED FOR REPORT

FIGURE No. D-3
**RAINBOW VALLEY BRIDGES RENEWAL
AND WIDENING**

1962 AERIAL PHOTO

THIS DRAWING IS FOR THE USE OF THE CLIENT AND PROJECT INDICATED - NO REPRESENTATIONS OF ANY KIND ARE MADE TO OTHER PARTIES

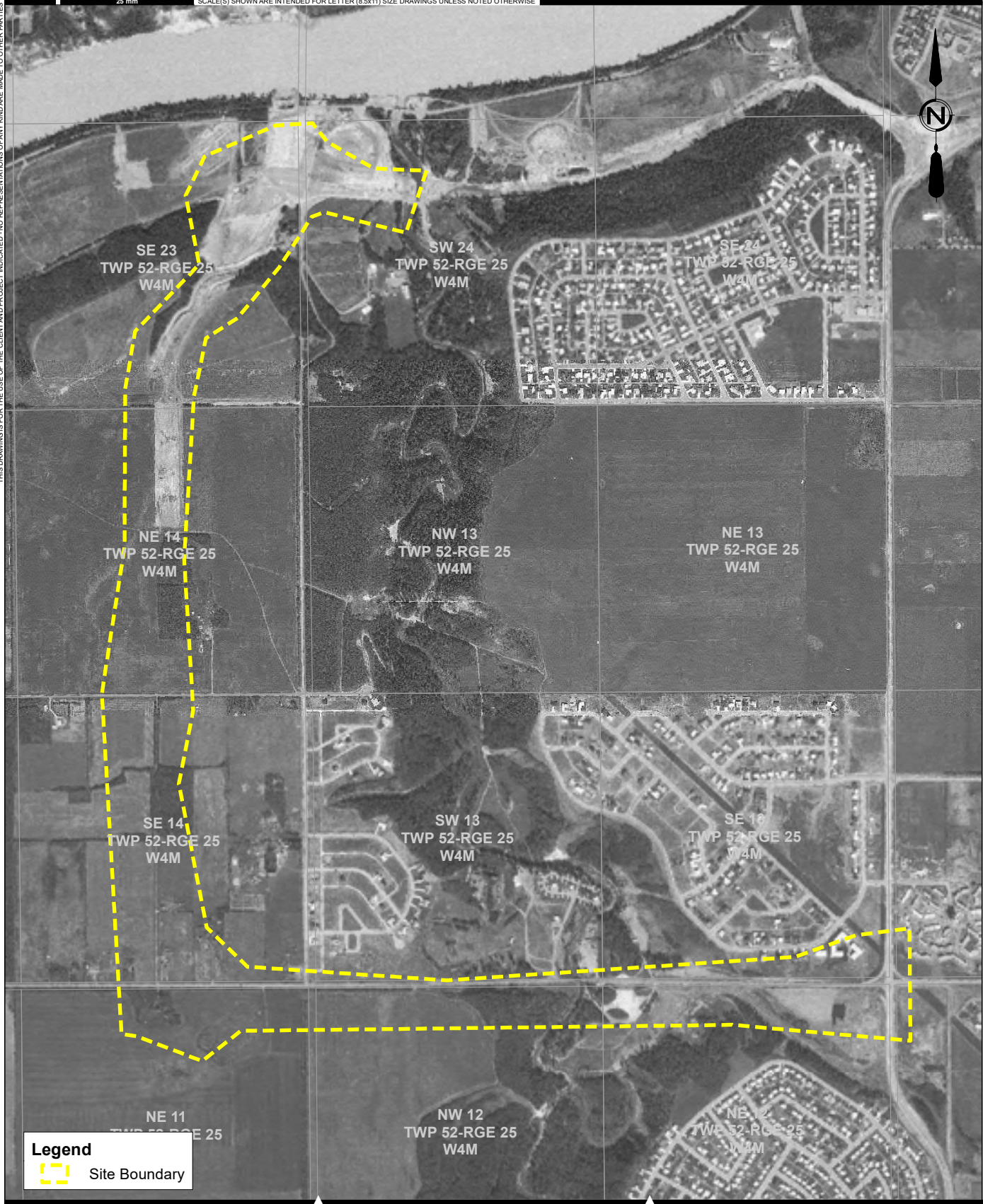

\\sadm-fs-01\working\2019-3585-00\gis\ArcMap\Rainbow_ValleyProject\WhiteMud_Drive\RainbowValley\FigD_HistoricalPhotos.mxd
DATE: 3/2/2020

Legend
 Site Boundary



AE PROJECT No. 2019-3585
DATE 2020 MARCH
SCALE 1:15,000
COORD. SYSTEM NAD 1983 CSRS 3TM 114
REV
DESCRIPTION ISSUED FOR REPORT

FIGURE No. D-4
RAINBOW VALLEY BRIDGES RENEWAL AND WIDENING
 1967 AERIAL PHOTO

THIS DRAWING IS FOR THE USE OF THE CLIENT AND PROJECT INDICATED - NO REPRESENTATIONS OF ANY KIND ARE MADE TO OTHER PARTIES

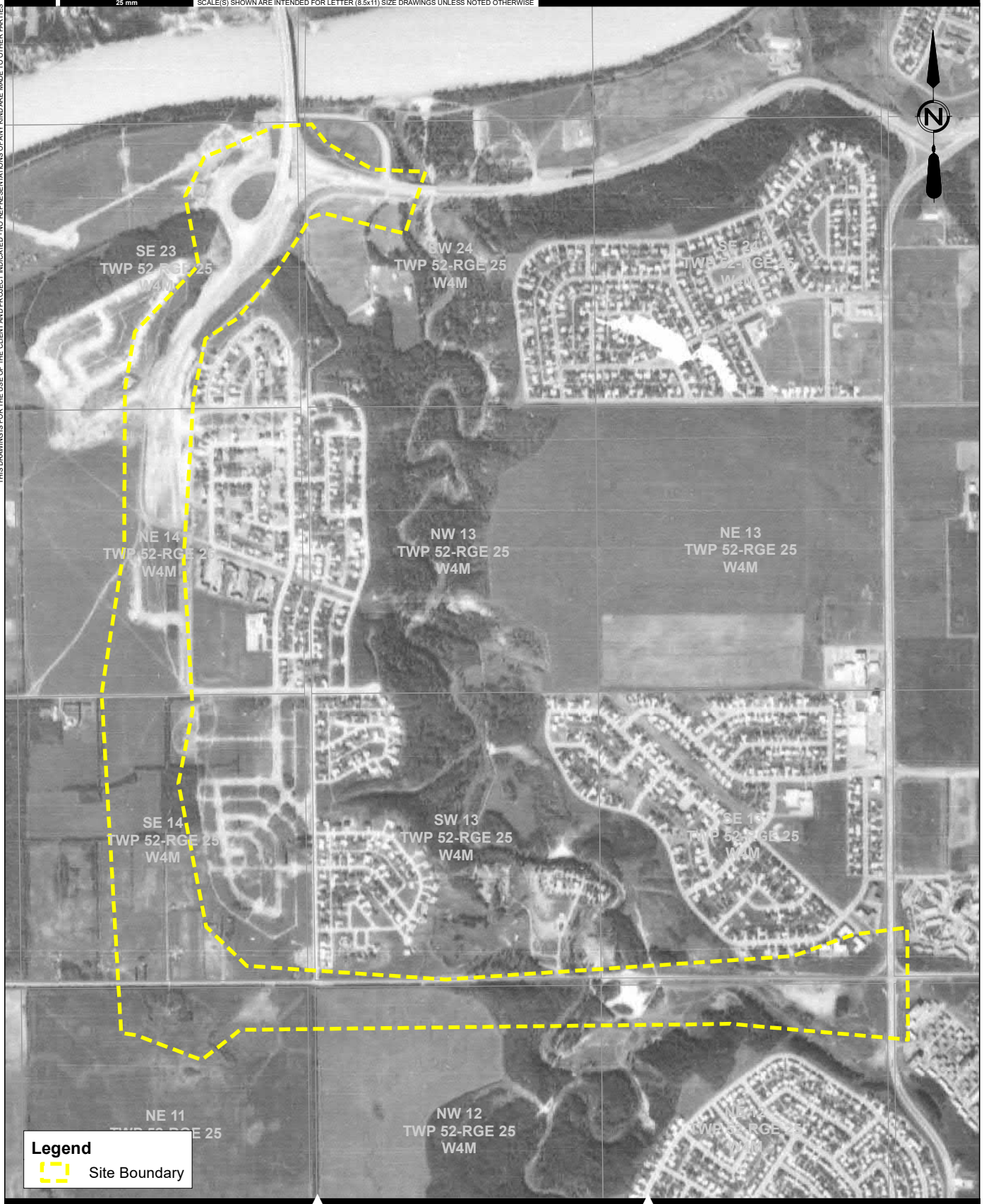

\\sdrh-fs-01\working\2019-3585-00\gis\ArcMap\Rainbow_ValleyProject\WhiteMud_Drive\RainbowValley\FigD_HistoricalPhotos.mxd
DATE: 3/2/2020

Legend
 Site Boundary



AE PROJECT No. 2019-3585
DATE 2020 MARCH
SCALE 1:15,000
COORD. SYSTEM NAD 1983 CSRS 3TM 114
REV
DESCRIPTION ISSUED FOR REPORT

FIGURE No. D-5
RAINBOW VALLEY BRIDGES RENEWAL AND WIDENING
 1970 AERIAL PHOTO

THIS DRAWING IS FOR THE USE OF THE CLIENT AND PROJECT INDICATED - NO REPRESENTATIONS OF ANY KIND ARE MADE TO OTHER PARTIES



\\sdrh-fs-01\working\2019-3585-00\gis\ArcMap\Rainbow_ValleyProject\WhiteMud_Drive\Map\Rainbow_Valley\HistoricalPhotos.mxd
DATE: 3/2/2020

Legend
 Site Boundary



AE PROJECT No. 2019-3585
DATE 2020 MARCH
SCALE 1:15,000
COORD. SYSTEM NAD 1983 CSRS 3TM 114
REV
DESCRIPTION ISSUED FOR REPORT

FIGURE No. D-6
RAINBOW VALLEY BRIDGES RENEWAL AND WIDENING
 1977 AERIAL PHOTO

THIS DRAWING IS FOR THE USE OF THE CLIENT AND PROJECT INDICATED - NO REPRESENTATIONS OF ANY KIND ARE MADE TO OTHER PARTIES

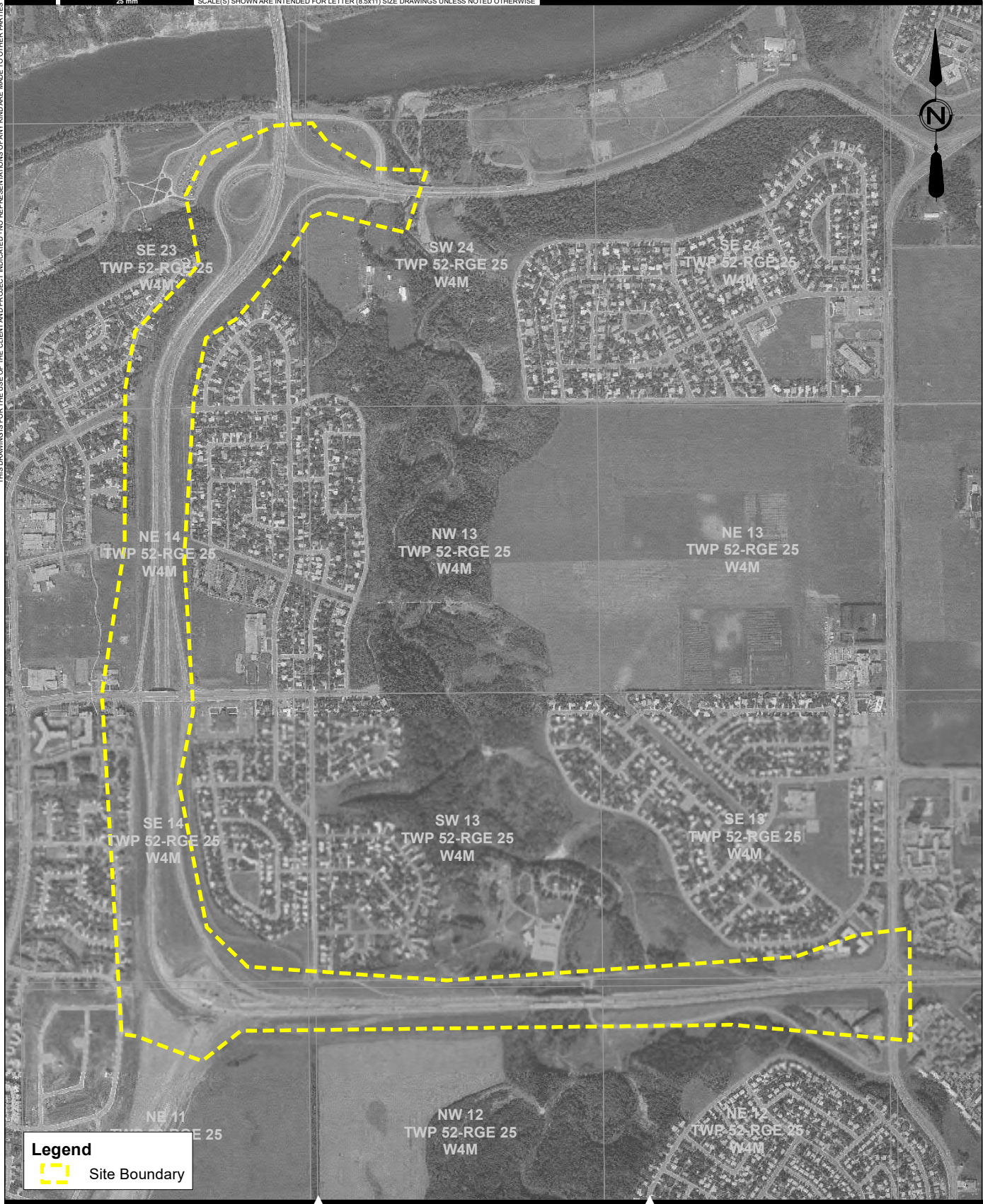

Legend
 Site Boundary

\\cedm-fs-01\working\2019-3585-00\gis\ArcMap\Rainbow_ValleyProject\WhiteMud_Drive\RainbowValley\FigD_HistoricalPhotos.mxd
DATE: 3/2/2020



AE PROJECT No. 2019-3585
DATE 2020 MARCH
SCALE 1:15,000
COORD. SYSTEM NAD 1983 CSRS 3TM 114
REV
DESCRIPTION ISSUED FOR REPORT

FIGURE No. D-7
RAINBOW VALLEY BRIDGES RENEWAL AND WIDENING
 1982 AERIAL PHOTO

THIS DRAWING IS FOR THE USE OF THE CLIENT AND PROJECT INDICATED - NO REPRESENTATIONS OF ANY KIND ARE MADE TO OTHER PARTIES



Legend
 Site Boundary

\\sdrh-fs-01\working\2019-3585-00\gis\ArcMap\Rainbow_Valley\Project\WhiteMud_Drive\MapRainbow_Valley\FigD_HistoricalPhotos.mxd
DATE: 3/2/2020



AE PROJECT No. 2019-3585
DATE 2020 MARCH
SCALE 1:15,000
COORD. SYSTEM NAD 1983 CSRS 3TM 114
REV
DESCRIPTION ISSUED FOR REPORT

FIGURE No. D-8
RAINBOW VALLEY BRIDGES RENEWAL AND WIDENING
 1987 AERIAL PHOTO

THIS DRAWING IS FOR THE USE OF THE CLIENT AND PROJECT INDICATED - NO REPRESENTATIONS OF ANY KIND ARE MADE TO OTHER PARTIES

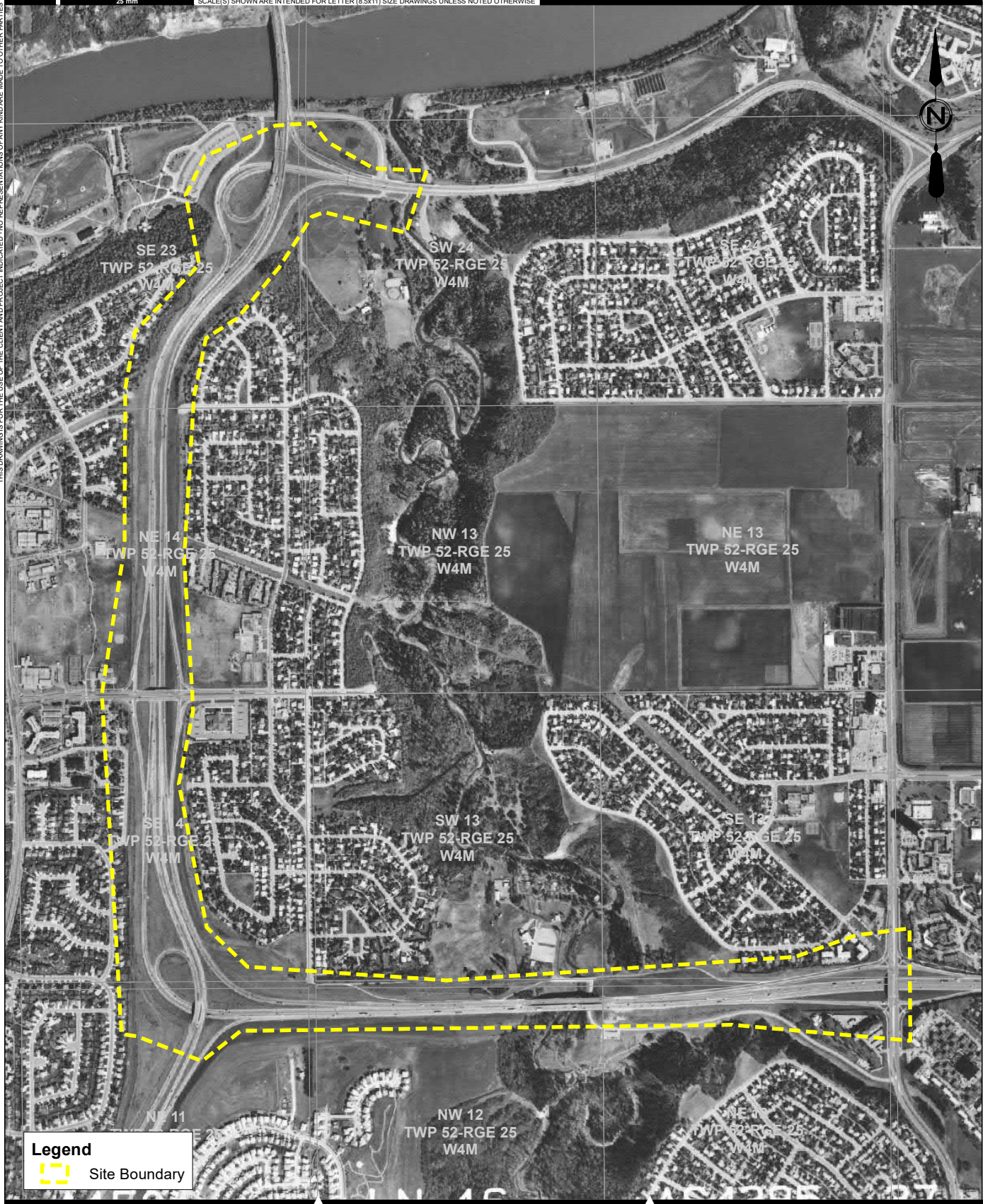

Legend
 Site Boundary

\\sdrh-fs-01\working\2019-3585-00\gis\ArcMap\Rainbow_ValleyProject\WhiteMud_Drive\MapRainbow_ValleyProject\WhiteMud_Drive\MapRainbow_ValleyProject\HistoricalPhotos.mxd
DATE: 3/2/2020



AE PROJECT No. 2019-3585
DATE 2020 MARCH
SCALE 1:15,000
COORD. SYSTEM NAD 1983 CSRS 3TM 114
REV
DESCRIPTION ISSUED FOR REPORT

FIGURE No. D-9
RAINBOW VALLEY BRIDGES RENEWAL AND WIDENING
 1993 AERIAL PHOTO

IF NOT 25 mm ADJUST SCALES
25 mm

SCALE(S) SHOWN ARE INTENDED FOR LETTER (8.5x11) SIZE DRAWINGS UNLESS NOTED OTHERWISE

THIS DRAWING IS FOR THE USE OF THE CLIENT AND PROJECT INDICATED - NO REPRESENTATIONS OF ANY KIND ARE MADE TO OTHER PARTIES

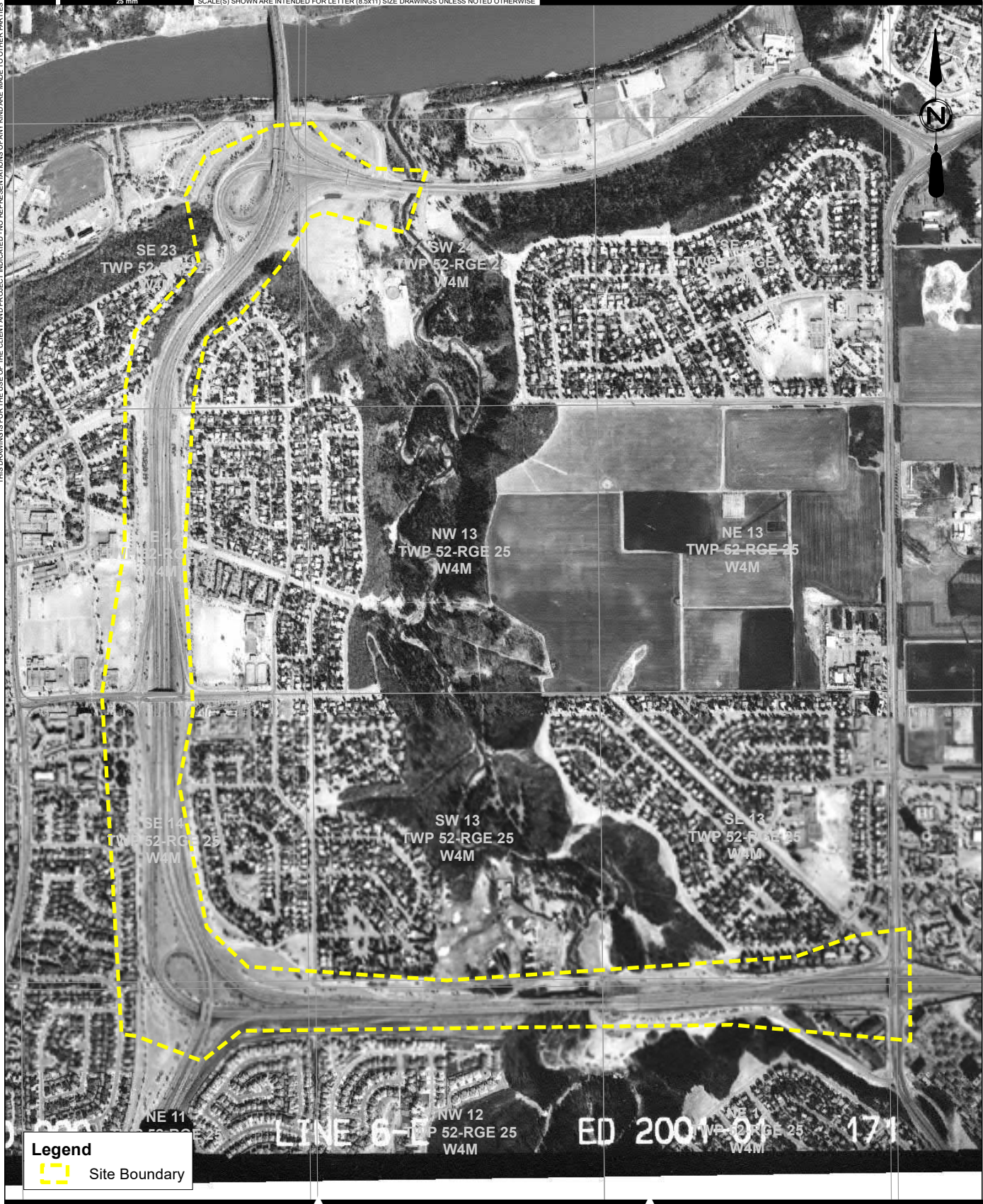

Legend
 Site Boundary

\\sadm-fs-01\working\2019-3585-00\gis\ArchMap\Rainbow_ValleyProject\WhiteMud_Drive\MapRainbow_ValleyProject\HistoricalPhotos.mxd
DATE: 3/2/2020



AE PROJECT No. 2019-3585
DATE 2020 MARCH
SCALE 1:15,000
COORD. SYSTEM NAD 1983 CSRS 3TM 114
REV
DESCRIPTION ISSUED FOR REPORT

FIGURE No. D-10
RAINBOW VALLEY BRIDGES RENEWAL AND WIDENING
 2001 AERIAL PHOTO

THIS DRAWING IS FOR THE USE OF THE CLIENT AND PROJECT INDICATED - NO REPRESENTATIONS OF ANY KIND ARE MADE TO OTHER PARTIES

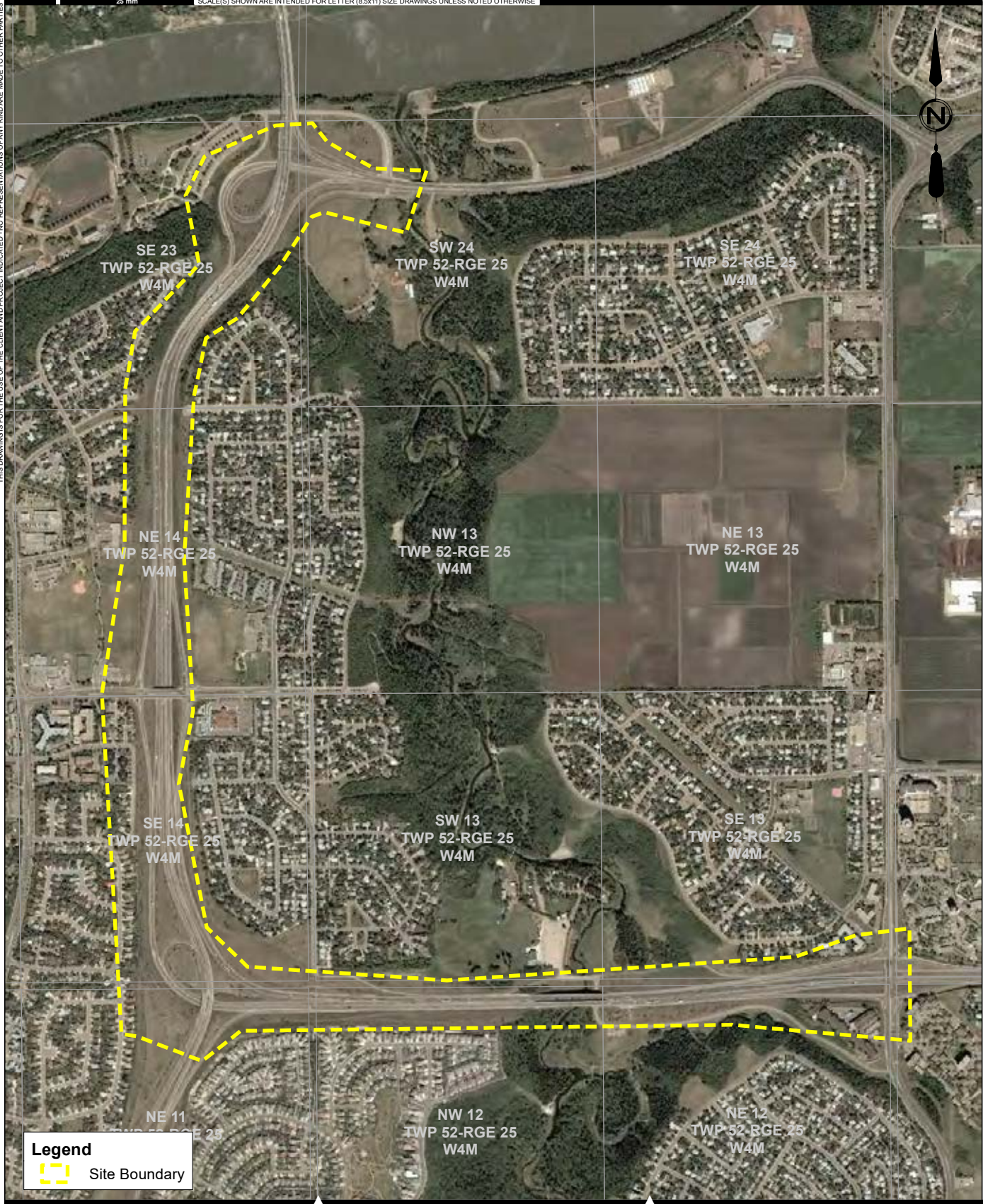

Legend
 Site Boundary

\\sdrh-fs-01\working\2019-3585-00\gis\ArcMap\Rainbow_ValleyProject\WhiteMud_Drive\RainbowValley\FigD_HistoricalPhotos.mxd
DATE: 3/2/2020



AE PROJECT No. 2019-3585
DATE 2020 MARCH
SCALE 1:15,000
COORD. SYSTEM NAD 1983 CSRS 3TM 114
REV
DESCRIPTION ISSUED FOR REPORT

FIGURE No. D-11
RAINBOW VALLEY BRIDGES RENEWAL AND WIDENING
 2004 AERIAL PHOTO

IF NOT 25 mm ADJUST SCALES
25 mm

SCALE(S) SHOWN ARE INTENDED FOR LETTER (8.5x11) SIZE DRAWINGS UNLESS NOTED OTHERWISE

THIS DRAWING IS FOR THE USE OF THE CLIENT AND PROJECT INDICATED - NO REPRESENTATIONS OF ANY KIND ARE MADE TO OTHER PARTIES

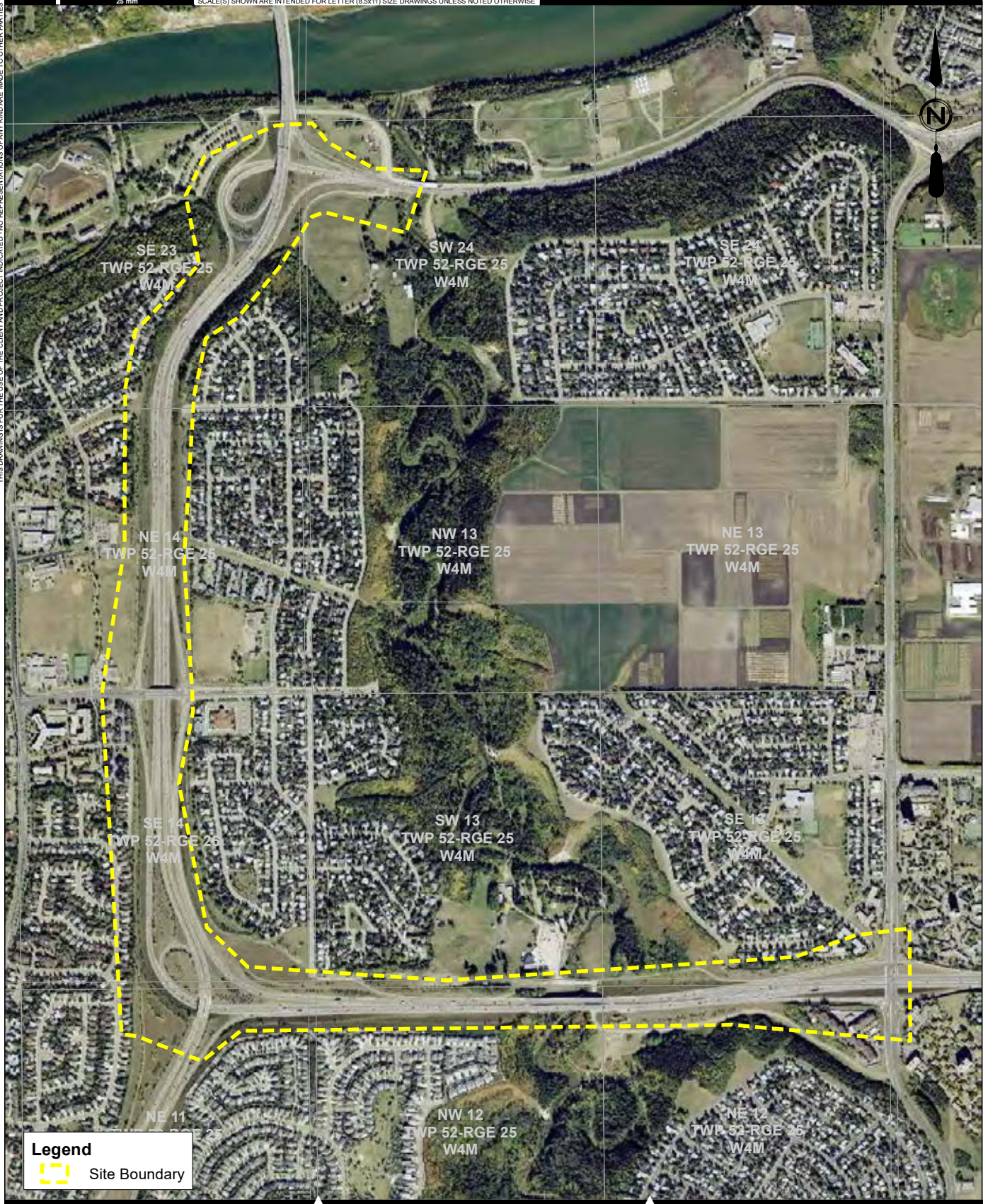

Legend
 Site Boundary

\\sdrh-fs-01\working\2019-3585-00\gis\ArcMap\Rainbow_ValleyProject\WhiteMud_Drive\RainbowValley\FigD_HistoricalPhotos.mxd
 DATE: 3/2/2020



AE PROJECT No. 2019-3585
DATE 2020 MARCH
SCALE 1:15,000
COORD. SYSTEM NAD 1983 CSRS 3TM 114
REV
DESCRIPTION ISSUED FOR REPORT

FIGURE No. D-12
RAINBOW VALLEY BRIDGES RENEWAL AND WIDENING
 2008 AERIAL PHOTO

THIS DRAWING IS FOR THE USE OF THE CLIENT AND PROJECT INDICATED - NO REPRESENTATIONS OF ANY KIND ARE MADE TO OTHER PARTIES



Legend
 Site Boundary

\\sdrh-fs-01\working\2019-3585-00\gis\ArcMap\Rainbow_ValleyProject\WhiteMud_Drive\RainbowValley\FigD_HistoricalPhotos.mxd
DATE: 3/2/2020



AE PROJECT No. 2019-3585
DATE 2020 MARCH
SCALE 1:15,000
COORD. SYSTEM NAD 1983 CSRS 3TM 114
REV
DESCRIPTION ISSUED FOR REPORT

FIGURE No. D-13
RAINBOW VALLEY BRIDGES RENEWAL AND WIDENING
 2012 AERIAL PHOTO

THIS DRAWING IS FOR THE USE OF THE CLIENT AND PROJECT INDICATED - NO REPRESENTATIONS OF ANY KIND ARE MADE TO OTHER PARTIES

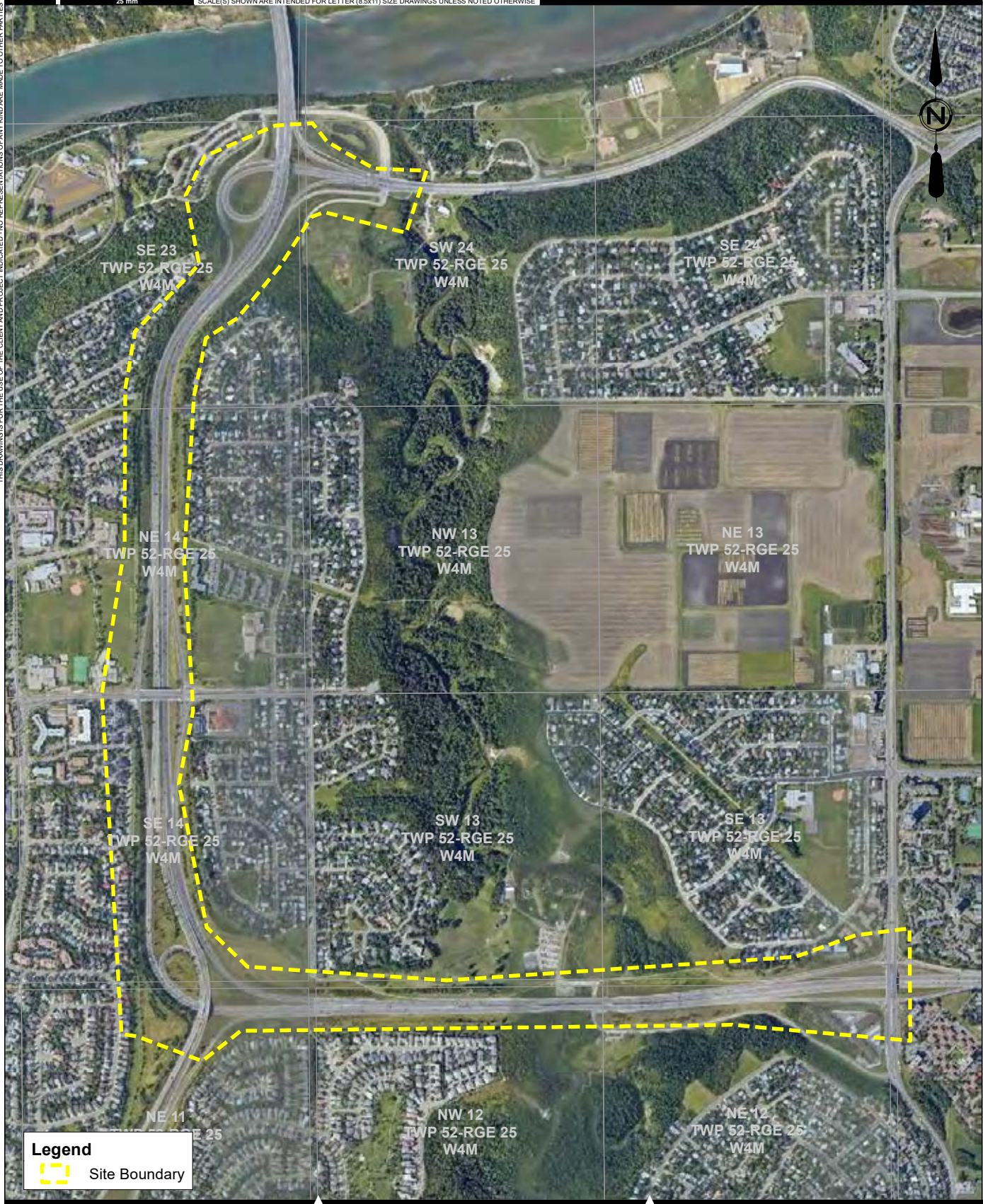

Legend
 Site Boundary

\\sdrh-fs-01\working\2019-3585-00\gis\ArcMap\Rainbow_ValleyProject\WhiteMud_DriveRainbowValley\FigD_HistoricalPhotos.mxd
DATE: 3/2/2020



AE PROJECT No. 2019-3585
DATE 2020 MARCH
SCALE 1:15,000
COORD. SYSTEM NAD 1983 CSRS 3TM 114
REV
DESCRIPTION ISSUED FOR REPORT

FIGURE No. D-14
RAINBOW VALLEY BRIDGES RENEWAL AND WIDENING
 2017 AERIAL PHOTO

APPENDIX E - WATER WELL RECORDS

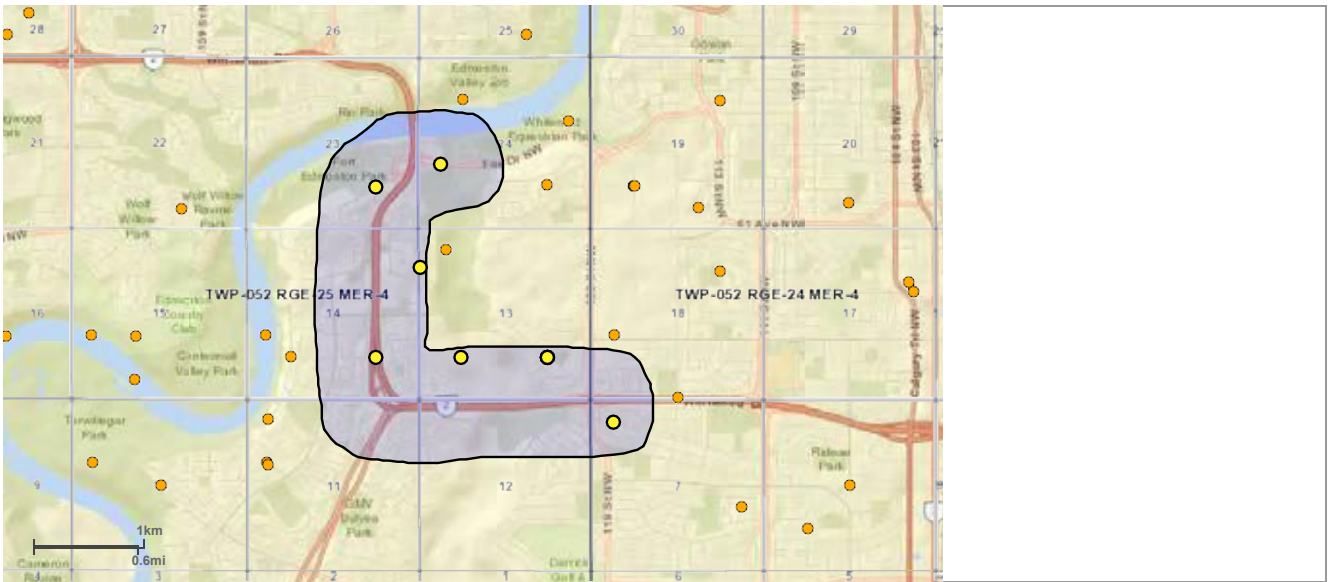

Alberta Water Well Information Database Map

Projection

Web Mercator (Auxillary Sphere)

Datum

WGS 84

Date

2/11/2020 11:16:25 AM

Legend

● Groundwater Drilling Report

◆ Baseline Water Well Report

<http://groundwater.alberta.ca/WaterWells/>

Information as depicted is subject to change, therefore the Government of Alberta assumes no responsibility for discrepancies at time of use.
© 2009 Government of Alberta
© Government of Alberta | Copyright Government of Alberta | Esri, HERE, Garmin, NGA, USGS, NPS



Reconnaissance (Summary) Sheet

This list summarizes the groundwater data held by Alberta Environment and Parks for specified areas. The list does not reflect the exact number or location of water wells for that area. Some data will appear multiple times on the summary sheet, reflecting that separate well tests have been done over time.

- Depth is reported in feet (or metres) from the surface
- CHM = number of chemical analyses held on file
- LT = number of lines of lithology
- PT = number of lines of pump test data (drawdown and/or recovery)
- Static level is reported in feet (or metres) from the surface (unless otherwise reported in the Additional Comments on Well section on the drilling report)

Colour Coding of Reconnaissance Report Based on Type of Work	
Green	New Well
Light Green	Deepened, Reconstructed, Reconditioned
Blue	Chemistry only
Red	Dry Hole, Dry Hole-Abandoned, New Well-Abandoned, Old Well-Abandoned, Test Hole-Abandoned
Brown	Spring, Flowing Shot Hole
White	Piezometer, Well Inventory, Old Well-Test, Test Hole, Other, Unknown



Reconnaissance Report

[View in Imperial](#)

[Export to Excel](#)

Groundwater Wells

Please click the water Well ID to generate the Water Well Drilling Report.

GIC Well ID	LSD	SEC	TWP	RGE	M	DRILLING COMPANY	DATE COMPLETED	DEPTH (m)	TYPE OF WORK	USE	CHM	LT	PT	WELL OWNER	STATIC LEVEL (m)	TEST RATE (L/min)	SC_DIA (cm)
75026	SE	23	52	25	4	UNKNOWN DRILLER		0.00	Chemistry	Domestic	1			DROUIN, FRANK			0.00
75029	5	24	52	25	4	UNKNOWN DRILLER		0.00	Spring	Unknown				WHITE MUD CREEK PARK			0.00
75087	13	13	52	25	4	UNKNOWN DRILLER	1953-08-19	349.00	Core Hole	Industrial				UNION OIL CO OF CALIF#CH5			0.00
79200	13	7	52	24	4	UNKNOWN DRILLER		4.88	Federal Well Survey	Domestic & Stock				CALDER, H.A.			0.00
2093334	SE	14	52	25	4	UNKNOWNDRILLINGCOMP11	1921-08-08	16.76	Other	Domestic & Stock		1		BLACK, G.L.			60.96
2093443	SW	13	52	25	4	UNKNOWNDRILLINGCOMP11	1958-07-08	45.72	New Well	Industrial		19	3	RED HOT COAL COMPANY	0.61	4.55	10.16
2093443	SW	13	52	25	4	UNKNOWNDRILLINGCOMP11	1958-07-08	45.72	New Well	Industrial		19	3	RED HOT COAL COMPANY	0.61	22.73	10.16
2093480	SE	13	52	25	4	UNKNOWNDRILLINGCOMP11		74.07	New Well- Decommissioned	Domestic		18					
2096405	SE	13	52	25	4	UNKNOWNDRILLINGCOMP11	1962-07-01		Chemistry	Unknown	1	1		AGRO SALES LTD.			
2096482	SE	13	52	25	4	UNKNOWNDRILLINGCOMP11		62.79	Chemistry	Unknown	1	1		ROBERTSON, R. T.			

APPENDIX F - OIL AND GAS WELLS AND PIPELINES

Pipelines and Oil and Gas Wells

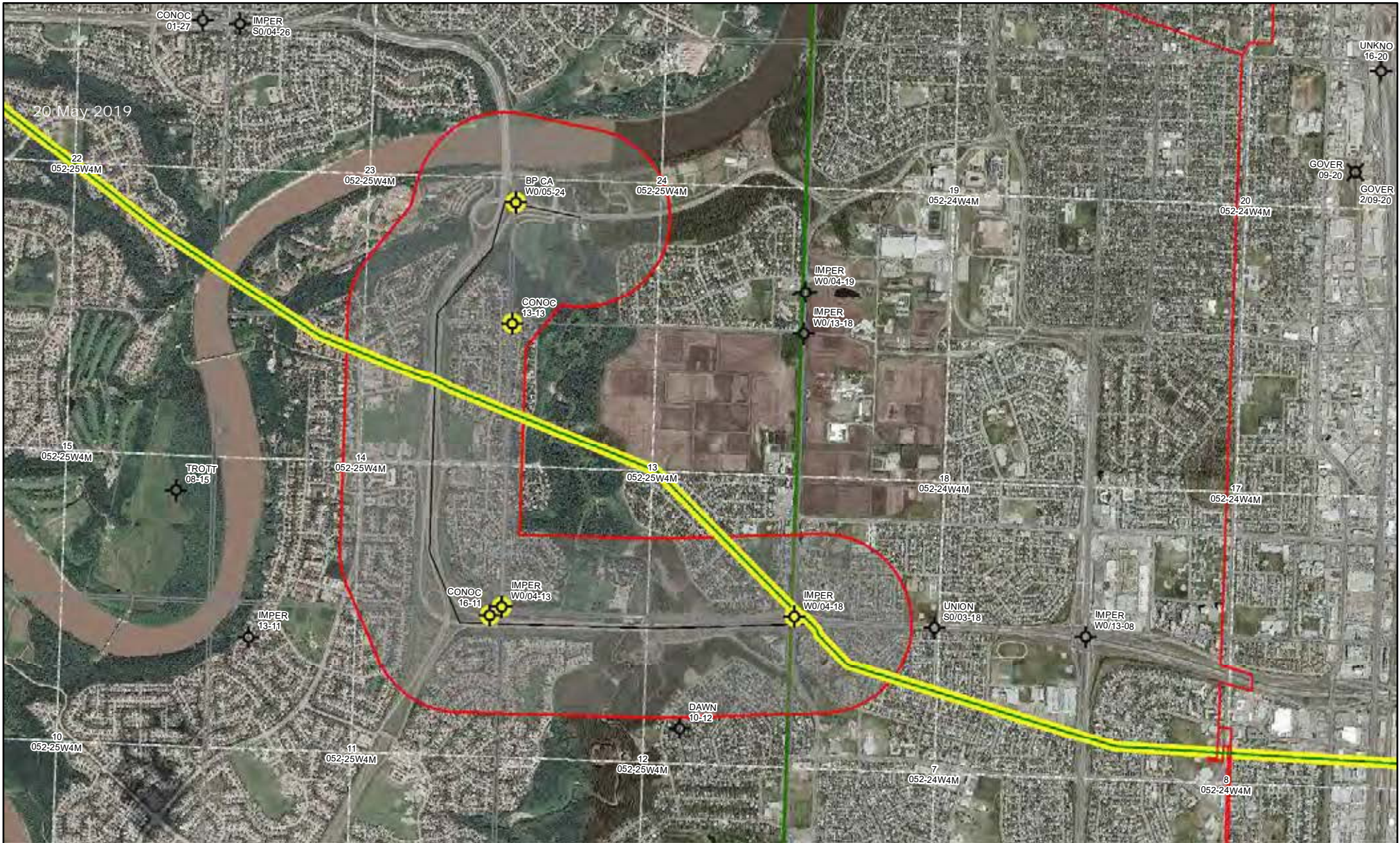

20 May 2019

Tuesday, February 11, 2020

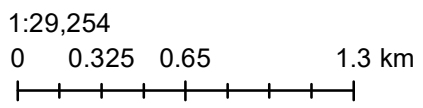



Pipeline Information

UNKNOWN COMPANY | 80045 - 1

AER Pipeline Data Current to January 13, 2020

Permit Date:	January 22, 1998	License Date:	
From Location:	4-5-53-23 W4M PT	To Location:	16-13-53-6 W5M PS
Length:	99.4 kms 62.12 mi	Status:	O
Substance:	CO	H₂S:	0 mol/kmol 0 ppm
Outside Diameter:	610 mm 24.02 "	Wall Thickness:	6.35 mm 0.25 "
Material:	S	Type:	5L
Grade:	X52	Max Operating Pressure:	5380 kPa 780 psi
Joints:	W	Internal Coating:	U
Stress Level:	72 %	Environment:	RC
Original Permit Date:	January 22, 1998	Construction Date:	
Original License/Line No:	80045 - 1	NEB Registration:	Yes
Abacus No:	N/A		



Well Information

1W0 / 04-13-052-25 W4 / 0

IMPERIAL OIL LIMITED | 1W0 / 04-13-052-25 W4 / 0

Government Well Data Current To January 1, 2020

License #:	0001934I	License Date:	August 28, 1950
Well Name:	IMP 9 CAMAO TH 4-13-52-25		
License Status:	RecExempt	License Status Date:	August 29, 1950
Within:	04-13-052-25 W4M	H2S (%):	
Spud Date:	August 28, 1950	Final Drill Date:	August 28, 1950
Status:	ABD	Abandoned Date:	August 29, 1950
Surface:		Downhole:	
Offsets:	N 19.5 W 1619.1	Offsets:	N 19.5 W 1619.1
Latitude:	53.483344	Latitude:	53.483344
Longitude:	-113.565681	Longitude:	-113.565681
Ground Elevation:	670.9 m 2201 '	Total Depth:	167.00 m 548 '
Operator:	n/a		



Well Information

1W0 / 04-18-052-24 W4 / 0

IMPERIAL OIL LIMITED | 1W0 / 04-18-052-24 W4 / 0

Government Well Data Current To January 1, 2020

License #:	0001934H	License Date:	August 28, 1950
Well Name:	IMP 8 CAMAO TH 4-18-52-24		
License Status:	RecExempt	License Status Date:	August 29, 1950
Within:	04-18-052-24 W4M	H2S (%):	
Spud Date:	August 28, 1950	Final Drill Date:	August 28, 1950
Status:	ABD	Abandoned Date:	August 29, 1950
Surface:		Downhole:	
Offsets:	N 22.6 W 1619.3	Offsets:	N 22.6 W 1619.3
Latitude:	53.483376	Latitude:	53.483376
Longitude:	-113.541049	Longitude:	-113.541049
Ground Elevation:	666.6 m 2187 '	Total Depth:	152.00 m 499 '
Operator:	n/a		



Well Information

1W0 / 05-24-052-25 W4 / 0

BP CANADA ENERGY GROUP ULC | 1W0 / 05-24-052-25 W4 / 0

Government Well Data Current To January 1, 2020

License #:	0002483W	License Date:	January 2, 1951
Well Name:	DOME 23 ST. ALBERT TH 5-24-52-25		
License Status:	RecExempt	License Status Date:	January 3, 1951
Within:	05-24-052-25 W4M	H2S (%):	
Spud Date:	January 2, 1951	Final Drill Date:	January 2, 1951
Status:	ABD	Abandoned Date:	January 3, 1951
Surface:		Downhole:	
Offsets:	N 670.6 W 1619.3	Offsets:	N 670.6 W 1619.3
Latitude:	53.503670	Latitude:	53.503670
Longitude:	-113.565711	Longitude:	-113.565711
Ground Elevation:	623.9 m 2047 '	Total Depth:	153.00 m 502 '
Operator:	n/a		



Well Information

100 / 13-13-052-25 W4 / 0

CONOCOPHILLIPS CANADA RESOURCES CORP. | 100 / 13-13-052-25 W4 / 0

Government Well Data Current To January 1, 2020

License #:	0002865G	License Date:	May 10, 1951
Well Name:	ROYALITE 7 STONY TH 13-13-52-25		
License Status:	RecExempt	License Status Date:	May 11, 1951
Within:	13-13-052-25 W4M	H2S (%):	
Spud Date:	May 10, 1951	Final Drill Date:	May 10, 1951
Status:	ABD	Abandoned Date:	May 11, 1951
Surface:		Downhole:	
Offsets:	S 7.6 E 1	Offsets:	S 7.6 E 1
Latitude:	53.497573	Latitude:	53.497573
Longitude:	-113.565637	Longitude:	-113.565637
Ground Elevation:	707.4 m 2321 '	Total Depth:	245.00 m 804 '
Operator:	n/a		



Well Information

100 / 16-11-052-25 W4 / 0

CONOCOPHILLIPS CANADA RESOURCES CORP. | 100 / 16-11-052-25 W4 / 0

Government Well Data Current To January 1, 2020

License #:	0002865H	License Date:	May 10, 1951
Well Name:	ROYALITE 8 STONY TH 16-11-52-25		
License Status:	RecExempt	License Status Date:	May 11, 1951
Within:	16-11-052-25 W4M	H2S (%):	
Spud Date:	May 10, 1951	Final Drill Date:	May 10, 1951
Status:	ABD	Abandoned Date:	May 11, 1951
Surface:		Downhole:	
Offsets:	S 10.7 W 57.9	Offsets:	S 10.7 W 57.9
Latitude:	53.482892	Latitude:	53.482892
Longitude:	-113.566673	Longitude:	-113.566673
Ground Elevation:	708.1 m 2323 '	Total Depth:	244.00 m 801 '
Operator:	n/a		

APPENDIX G - AER SPILLS AND COMPLAINTS

Alberta Energy Regulator - Spills and Complaints

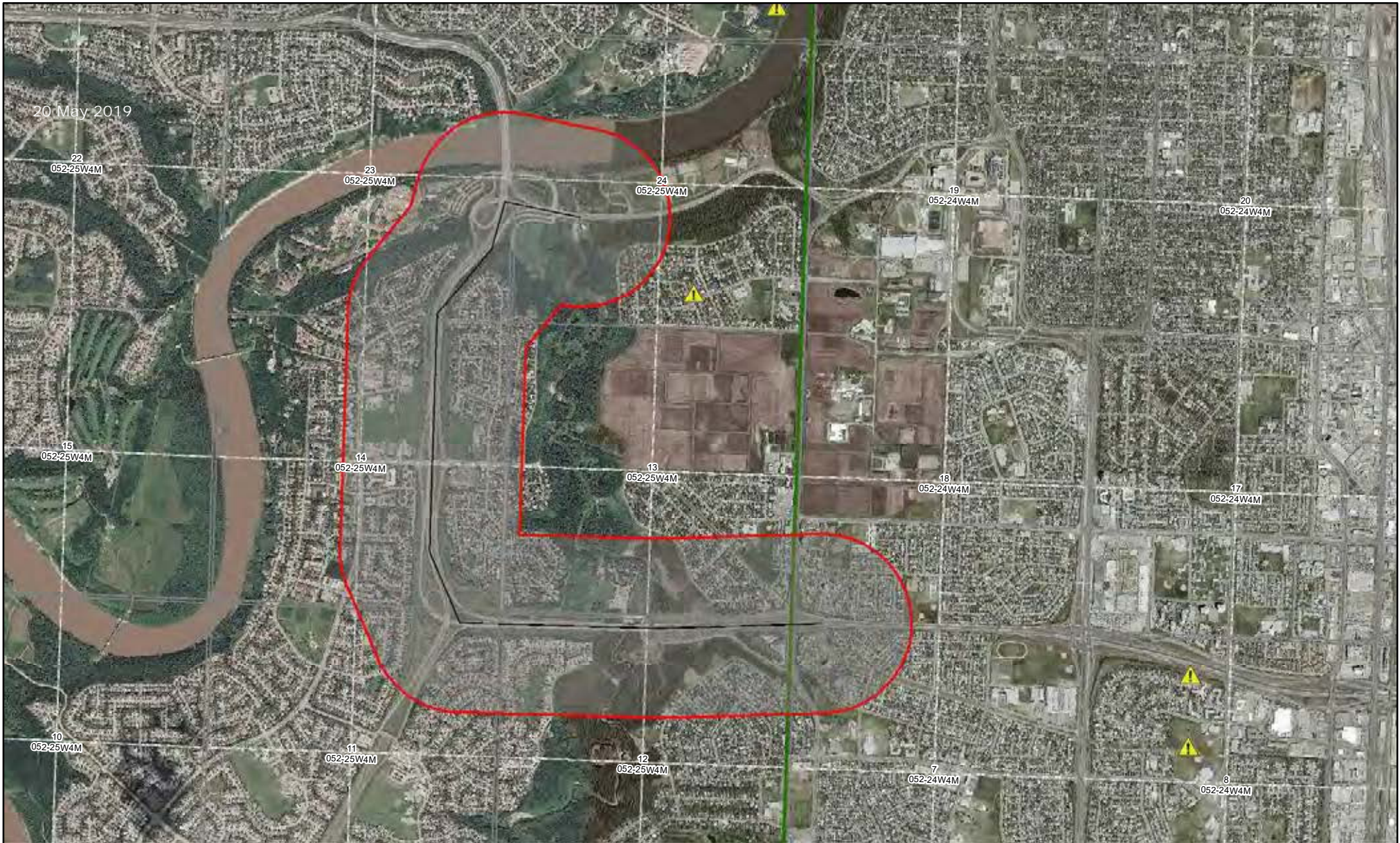

Tuesday, February 11, 2020

1:29,254

0 0.325 0.65 1.3 km

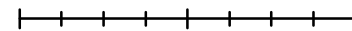

APPENDIX H - COAL MINE SEARCH

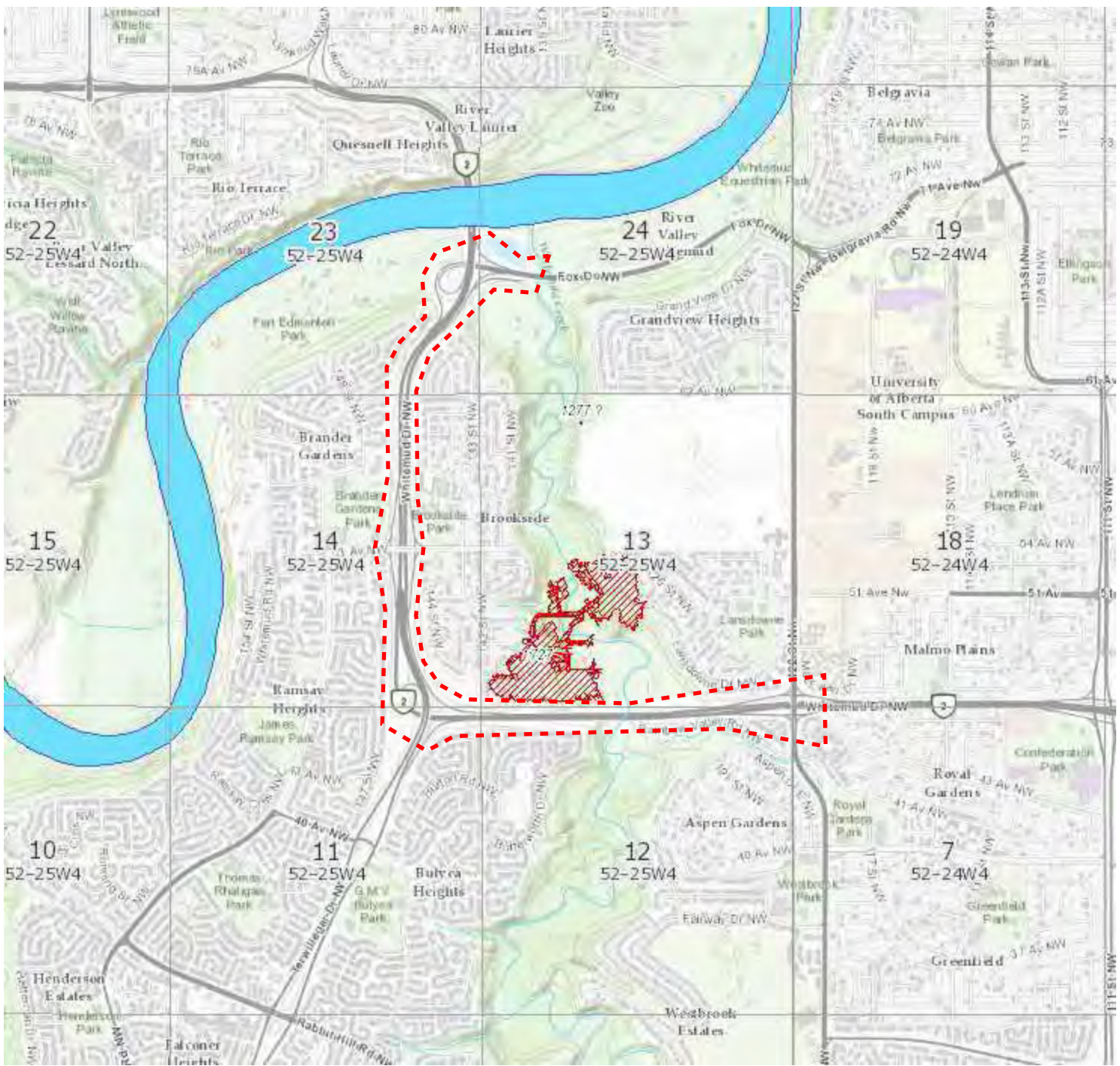

Coal Mine Map

Base Data provided by: Government of Alberta

Author: Danielle Loiselle

Printing Date: 2/11/2020

Date Date (if applicable)

The Alberta Energy Regulator (AER) has not verified and makes no representation or warranty as to the accuracy, completeness, or reliability of any information or data in this document or that it will be suitable for any particular purpose or use. The AER is not responsible for any inaccuracies, errors or omissions in the information or data and is not liable for any direct or indirect losses arising out of any use of this information. For additional information about the limitations and restrictions applicable to this document, please refer to the AER Copyright & Disclaimer webpage: <http://www.aer.ca/copyright-disclaimer>.

Scale: 50,000.00

0.76 Kilometers 0

Projection and Datum:

WGS84 Web Mercator Auxiliary Sphere



Legend

- ATS Townships (large scale)
- ATS Sections without Road Allowance
- ATS section labels (medium scale)
- Provincial Boundaries
- Coal Mine Permit
- Coal Mine Polygon
 - Surface
 - Underground
- Rail Line**
 - Rail Line
 - Abandoned Rail Line



Alberta Energy Regulator
Last Updated: May 15, 2015

Serial Publication: ST45

Coal Mine Atlas Operating and Abandoned Coal Mines in Alberta

Disclaimer: The abandoned coal mine information is for informative purposes and represents the best data available to the AER at this time but its accuracy cannot be guaranteed. The AER is not responsible for damages caused by the use of this information. In cases where there is a discrepancy between the coal mine data listing and the coal mine map, consider the coal mine data listing to be the most accurate.

Location S. -Rp. -R. M.	Location Tp. M. R. S.	Mine No.	Mine Name	Mine Company	T	S	Lifespan From To		Prod. (k tonnes)	Rank ASTM	Depth (m)	Thick (m)	Comments
36-052-24W4	05242436	1393/3	Ottewell	Ottewell Coal Co.	SF	A	1947	1950	9	S	-	2.1	
36-052-24W4	05242436	1104	Fulton Creek	Thomas Mather	UG	A	1923	1925	0	S	-	-	
36-052-24W4	05242436	1104/1	Fulton Creek	Thomas Mather	UG	A	1924	1924	0	S	-	-	
13-052-25W4	05242513	1277	Fridel's	Waclaw Fridel	UG	A	1928	1929	0	S	-	0.9	Prospecting.
13-052-25W4	05242513	1727	Red Hot	Whitemud Creek Coal Co. Ltd.	UG	A	1952	1970	248	S	60.3	1.9	
36-052-25W4	05242536	9003	Robinson's	Alex Robinson	UG	A	1880	1880	0	S	-	-	Previous Mine Number 0000/RBN - Changed Feb 05 2013; Previous Mine Number 0000/VRY - Changed Feb 05 2013. Date of operation and coal production are unknown . No ATS survey location given for this mine. Owner resided in Leduc.
36-052-25W4	05242536	9025	Groat Ravine	Verey and McPherson	UG	A	1889	1889	0	S	-	-	Previous Mine Number 0000/RBN - Changed Feb 05 2013; Previous Mine Number 0000/VRY - Changed Feb 05 2013. Date of operation and coal production are unknown . No ATS survey location given for this mine. Owner resided in Leduc.
35-052-26W4	05242635	0102	Wilson's	John Wilson	UG	A	1904	1905	< 0.1	S	-	-	Mine abandoned due to water seepage from Lake Wabamun.
08-052-04W5	05250408	1715	Hy-Vale	Samuel Giovinazzo	SF	A	1950	1951	< 0.1	S	7.3	1.2	Mine did not operate from 1959 to 1963.
29-052-04W5	05250429	1592	Mount Royal	Mount Royal Collieries Ltd.	SF	A	1943	1963	51	S	7.6	3.4	Permit No. C88-8A. Operating mine.
29-052-04W5	05250429	1769	Highvale	TransAlta Corporation	SF	O	1969	2014	433575	S	59.3	8.9	Slope tunnel.
29-052-04W5	05250429	0319	Lakeview	Lakeview Coal Co.	UG	A	1911	1914	0	S	-	-	
30-052-04W5	05250430	0424	Mullen's	Mullen Coal Co.	SF	A	1914	1917	11	S	-	7.3	
33-052-05W5	05250533	1683	Sunburst	Donvie Collieries Ltd.	SF	A	1948	1951	3	S	15.2	2.9	Water seepage prevented mining to bottom of seam. Previous Mine Number 0000/WDY4 - Changed Feb 05 2013; Prospect tunnel driven 14.6 meters. Crosscut driven 23.7 meters.
04-052-03W6	05260304	9055/4	Wildhay River No.16	Blue Diamond Coal Company Li	UG	A	1928	1929	0	B	4	15	Previous Mine Number 0000/56A/01 - Changed Feb 05 2013; Bulk sample adit driven 30.5 meters. Crosscut driven 11.6 meters.
08-052-03W6	05260308	9062/1	Rock Lake A	Denison Mines Limited	UG	A	1969	1969	< 0.1	B	8.5	13	Previous Mine Number 0000/56A/02 - Changed Feb 05 2013; Bulk sample adit driven 30.8 meters.
08-052-03W6	05260308	9062/2	Rock Lake B	Denison Mines Limited	UG	A	1969	1969	< 0.1	B	8.5	2.9	Previous Mine Number 0000/WDY3 - Changed Feb 05 2013; Prospect tunnel driven 17.1 meters. Crosscut driven 12.8 meters.
08-052-03W6	05260308	9055/3	Wildhay River No.12	Blue Diamond Coal Company Li	UG	A	1928	1929	0	B	4.3	12	Previous Mine Number 0000/WDY1 - Changed Feb 05 2013; Prospect tunnel driven 16.1 meters. Crosscut driven 14.3 meters.
18-052-03W6	05260318	9055/1	Wildhay River No.1	Blue Diamond Coal Company Li	UG	A	1928	1929	0	B	4.4	12	Previous Mine Number 0000/WDY2 - Changed Feb 05 2013; Prospect adit driven 14.3 meters. Crosscut driven 16.5 meters.
18-052-03W6	05260318	9055/2	Wildhay River No.6	Blue Diamond Coal Company Li	UG	A	1928	1929	0	B	5.1	9.8	
02-053-21W4	05342102	1632	Beaver Hills	C.F. MacLachlan	SF	A	1945	1955	19	S	9.4	1.8	Previous Mine Number 0000/TRM - Changed Feb 05 2013. Coal production unknown.
06-053-23W4	05342306	9029	Trimble	J.A. Trimble and Son	UG	A	1902	1903	0	S	-	-	Previous Mine Number 0000/SMP - Changed Feb 05 2013; Coal production unknown.
06-053-23W4	05342306	9014	Simpson's	G.A. Simpson	UG	A	1884	1887	0	S	-	-	Consolidated into Mine No. 0099.
06-053-23W4	05342306	0283	Great West	Great West Coal Co. Ltd.	UG	A	1911	1914	68	S	59.7	1.5	Coal production unknown.
06-053-23W4	05342306	0096	Twyford's	Hugh Twyford	UG	A	1905	1905	0	S	-	-	Consolidated into Mine No. 0099.
06-053-23W4	05342306	0074	Milner No.2	John Milner	UG	A	1898	1911	11	S	39	1.7	
07-053-23W4	05342307	0066	Bishopric's	Bishopric and Grierson	UG	A	1902	1904	0	S	-	-	
07-053-23W4	05342307	0069	Blue Ribbon	Keith and Fulton	UG	A	1902	1937	165	S	39.1	1.9	
07-053-23W4	05342307	0085	Humberstone	William Humberstone	UG	A	1903	1904	1	S	-	-	
07-053-23W4	05342307	0089	Nonsuch	Great West Coal Co. Ltd.	UG	A	1904	1913	28	S	42.1	2.3	Consolidated in Mine No. 0099. Consolidated into Mine No. 0090 in 1907. Mine may possibly be the old workings encountered by Mine No. 0069.
07-053-23W4	05342307	0098	Booker's	Noah Booker	UG	A	1905	1907	1	S	-	-	
07-053-23W4	05342307	0099	Black Diamond	Great West Coal Co. Ltd.	UG	A	1903	1952	2799	S	63.4	1.5	

APPENDIX I - NATIONAL POLLUTANT RELEASE INVENTORY



National Pollutant Release Inventory



Figure J-1 – NPRI Search Results.

APPENDIX J - ENVIRONMENTAL SITE ASSESSMENT REPOSITORY

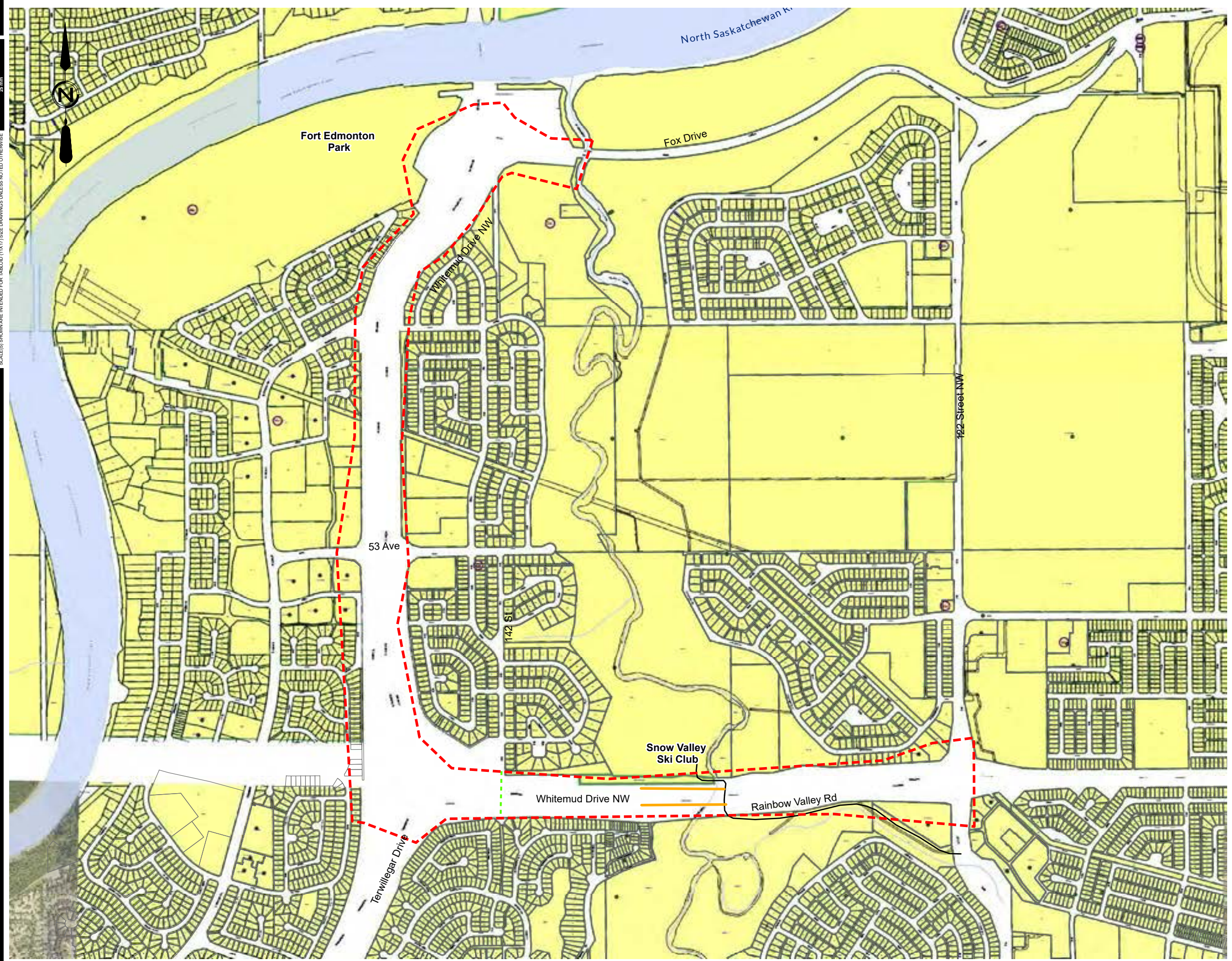

Legend

- Previous Environmental Site Assessments
- Rainbow Valley Bridges
- Rainbow Valley Road
- Future Pedestrian/Cyclist Bridge
- Site Boundary
- North Saskatchewan River Valley and Ravine System
- Water Body

FIGURE J-1
 RAINBOW VALLEY BRIDGES RENEWAL
 AND WIDENING
 ENVIRONMENTAL SITE ASSESSMENT REPOSITORY

AE PROJECT No.	2019-3585
SCALE	1:13,000
APPROVED DATE	2020MAY12
REV DESCRIPTION	ISSUED FOR REPORT

SAVE DATE: 6/12/2020 12:12:15 PM SAVED BY:
 DRAWING PATH: \\s-e-n-16-c1\working\2019-3585-00\gis\arcmap\Rainbow_Valley\Project\WhiteMud_Drive\RainbowValley\Fig-1_EnvironmentalSiteAssessmentRepository.mxd
 DATA SOURCE: Sources: Esri, HERE, Garmin, USGS, Intermap, INCREMENT P, NRCan, Esri Japan, METI, Esri China (Hong Kong), Esri Korea, Esri (Thailand), NGCC, (c) OpenStreetMap contributors, and the GIS User Community
 SCALE(S) SHOWN ARE INTENDED FOR TABLOID (11X17) SIZE DRAWINGS UNLESS NOTED OTHERWISE
 IF NOT 20 mm AS SHOWN SCALES

APPENDIX K – NICHOLS ENVIRONMENTAL (CANADA) LTD. - SPILL RESPONSE AND REMEDIATION PROGRAM

Spill Response and Remediation Program
Rainbow Valley Road Beneath Whitemud Drive
14-12-052-25-W4M
Edmonton, Alberta

AEP File No. 316940

Prepared for:
The City of Edmonton
Edmonton, Alberta

Prepared by:
Nichols Environmental (Canada) Ltd.
Edmonton, Alberta

Nichols File: 16-442-CRV
Date Issued: December 12, 2016



Nichols Environmental
(Canada) Ltd.

Head Office:
17331 - 107th Avenue
Edmonton, Alberta
T5S 1E5

nicholsenvironmental.com

P: 780 484 3377
F: 780 484 5093

The City of Edmonton
Remediation: Rainbow Valley Road
Beneath Whitemud Drive
Edmonton, Alberta



EXECUTIVE SUMMARY

Nichols Environmental (Canada) Ltd. has completed a Spill Response and Remediation Program for the Site located adjacent to Rainbow Valley Road beneath the Whitemud Drive overpass in Edmonton, Alberta. The incident was reported to Alberta Environment and Parks (AEP) on October 9, 2016 and is registered as AEP File No. 316940.

On October 5, 2016, a gravel truck travelling westbound on Whitemud Drive struck a bucket lift truck. The gravel truck caught fire and released an unknown volume of diesel fuel. The City of Edmonton Fire Rescue Services were on the scene to extinguish the fire, resulting in an undetermined volume of firefighting material and diesel fuel ('impacted water') running down the road surface and discharging through a drainage culvert to the parkland area below the Whitemud Drive overpass, adjacent to Rainbow Valley Road. A seepage pit was previously constructed directly below the drainage culvert, which subsequently overflowed with impacted water migrating overland and downgradient toward Whitemud Creek.

Nichols Environmental retained third-party contractors to provide the necessary personnel and equipment to complete the site remediation. The remedial excavation was completed by October 21, 2016 and the final excavation measured approximately 25 by 15 m in size and ranged in depth from 0.05 to 1.8 m. A total of 152.26 metric tonnes (t) of soil was excavated and disposed of at the MCL Waste Systems Class II landfill near Leduc, Alberta. Backfilling of the excavation and overall site restoration were completed on October 21 and 25, 2016.

All soil analytical results were compared to the 2016 Alberta Tier 1 Guidelines for Natural Area Land Use using fine-grained criteria, while surface water analytical results were compared to the 2014 Environmental Quality Guidelines for Alberta Surface Waters with the protection of aquatic life pathway being applicable.

The results of the soil sampling program indicated that all closure samples had both petroleum hydrocarbon (PHC) and polycyclic aromatic hydrocarbon (PAH) concentrations that were below their applicable guidelines. The results of the surface water sampling program indicated that all surface water samples had both PHC and PAH concentrations below their applicable guidelines.

Overall, the results of the Spill Response and Remediation Program indicate that closure sample PHC and PAH concentrations were below the recommended guidelines at the locations tested for both soil and surface water.

The statements made in this Executive Summary are subject to the same limitations included in Section 9.2, and are to be read in conjunction with the remainder of this report.



TABLE OF CONTENTS

Executive Summary	i
Table of Contents	ii
1.0 Introduction	1
1.1 Incident and Initial Response	1
2.0 Scope of Work	2
3.0 Site Description	4
3.1 Location and Development Details	4
3.2 Physical Description	4
3.3 Topography and Drainage	4
4.0 Methodology	5
4.1 Hazard Assessment and Utility Locations	5
4.2 Landfill Application	5
4.3 Excavation	5
4.4 Soil Sampling Program	6
4.5 Site Restoration	6
4.6 Survey	7
4.7 Surface Water Sampling	7
5.0 Assessment Guidelines	8
5.1 Regulatory Framework	8
5.2 Land Use Assessment	9
5.3 Water Well Search	9
5.4 Parameter Assessment	9
6.0 Field and Analytical Results	10
6.1 Soil Results	10
6.1.1 Organic Vapour Concentrations	10
6.1.2 Petroleum Hydrocarbons	10
6.1.3 Polycyclic Aromatic Hydrocarbons	10
6.1.4 Backfill Characterization	10



6.2	Surface Water Sampling Results	11
6.2.1	Petroleum Hydrocarbons	11
6.2.2	Polycyclic Aromatic Hydrocarbons	11
7.0	Conclusions and Recommendations	12
8.0	References	13
9.0	Qualifications and Limitations	14
9.1	Qualifications	14
9.2	Limitations	14
10.0	Closure	15

FIGURES

Figure 1	Site Location and Surrounding Land Use
Figure 2	Site Detail and Sample Locations
Figure 3	Soil Petroleum Hydrocarbon Data
Figure 4	Soil Polycyclic Aromatic Hydrocarbon Data
Figure 5	Surface Water Sample Location, Petroleum Hydrocarbon and Polycyclic Aromatic Hydrocarbon Data

TABLES

Table 1	Class II Landfill Characterization
Table 2	Excavation Sample Locations and Field Vapours
Table 3	Soil Analyses - Petroleum Hydrocarbons
Table 4	Soil Analyses - Polycyclic Aromatic Hydrocarbons
Table 5	Soil Analyses - Backfill Characterization
Table 6	Surface Water Analyses - Petroleum Hydrocarbons
Table 7	Surface Water Analyses - Polycyclic Aromatic Hydrocarbons



APPENDICES

Appendix A	Record of Site Condition
Appendix B	Site Photographs
Appendix C	Landfill Summary Report
Appendix D	Soil and Surface Water Methodologies
Appendix E	Signed Analytical Reports



1.0 INTRODUCTION

Nichols Environmental was retained by The City of Edmonton to conduct a Spill Response and Remediation Program adjacent to Rainbow Valley Road beneath the Whitemud Drive overpass, located in Edmonton, Alberta, and within 14-12-052-25-W4M (herein referred to as the "Site"). Figure 1 depicts the location of the Site relative to the surrounding area. As required by Alberta Environment and Parks (AEP), a completed Record of Site Condition is presented in Appendix A. A photographic summary of the investigation can be found in Appendix B.

The incident was reported to AEP on October 9, 2016 and is registered under AEP File No. 316940.

1.1 Incident and Initial Response

On October 5, 2016, at approximately 0330 hrs, a gravel truck travelling westbound on Whitemud Drive struck a bucket lift truck. The gravel truck caught fire and released an unknown volume of diesel fuel as a result of the collision. The City of Edmonton Fire Rescue Services were on the scene to extinguish the fire, resulting in an undetermined volume of firefighting material and diesel fuel ('impacted water') running down the road surface and discharging through a drainage culvert to the parkland area below the Whitemud Drive overpass, adjacent to Rainbow Valley Road. A seepage pit was previously constructed directly below the drainage culvert, which subsequently overflowed with impacted water migrating overland and downgradient toward Whitemud Creek. At the request of The City of Edmonton Fire Rescue Services, a City of Edmonton Drainage Services Crew was dispatched to the Site and contained the impacted water and diesel fuel on the road surface using booms. A waste disposal contractor mobilized to the Site later the same day to remove the contained liquids and some contaminated soil material. The road surface was later swept by The City of Edmonton, with the debris collected being disposed of at the Southwest District Yard.

The City of Edmonton's Engineering Services Section was contacted and mobilized to the Site on October 6, 2016 to complete an initial assessment and determine further spill cleanup and remediation requirements.

Nichols Environmental was contacted by The City of Edmonton at 1430 hrs on October 6, 2016 and arrived at the Site at 1530 hrs to provide initial response. A vacuum truck was also dispatched to provide product recovery, but given the setting of the Site, the vacuum truck could not reach the impacted area. Nichols Environmental initiated an emergency Alberta One-Call, delineated the release area, deployed absorbent booms and pads, hand-dug interceptor trenches at strategic locations, and collected soil samples for contaminant characterization and landfill classification. Although initial observations indicated that the release had not reached Whitemud Creek, a surface water sample was collected from the nearby Whitemud Creek for petroleum hydrocarbon analyses.

The approximate coordinates of the incident are N 53° 28' 57.35", W 113° 33' 18.30".



2.0 SCOPE OF WORK

Nichols Environmental completed the following scope of work as part of the Spill Response and Remediation Program:

- Mobilized to the Site to assess the extent of the spill area and collected a composite soil sample for landfill characterization;
- Collected a surface water sample from Whitemud Creek during the initial mobilization for laboratory analyses, and collected a second surface water sample from Whitemud Creek following the remedial excavation;
- Obtained and coordinated landfill approval through MCL Waste Systems;
- Prepared a site-specific health and safety plan and completed a hazard assessment;
- Contacted Alberta One-Call to locate public utility lines in the work area;
- Engaged a qualified private utility location firm to estimate the location of private utility lines;
- Contracted a vacuum truck contractor to provide support for potential product recovery during the initial response;
- Retained the services of a qualified contractor to provide the necessary personnel and equipment to excavate, haul and dispose of the impacted soils at MCL Waste Systems;
- Collected soil samples from the extent of the excavation to ensure the adequate lateral removal of impacted soils and vapour-screened each soil grab-sample collected from the excavation for field vapour concentrations;
- Submitted soil samples for laboratory analysis as follows:
 - ▶ Seven samples for benzene, toluene, ethylbenzene, xylenes (BTEX), and petroleum hydrocarbons (PHC) Fractions 1 through 4;
 - ▶ Eleven samples for polycyclic aromatic hydrocarbons (PAHs); and
 - ▶ One sample for grain size analyses;
- Submitted surface water samples for laboratory analysis as follows:
 - ▶ Two BTEX, and PHC Fractions 1 through 4; and
 - ▶ Two samples for PAHs;



- Coordinated with the excavation contractor the backfilling and restoration of the entire excavation following collection of the closure soil samples. A sample of the backfill material was also submitted for laboratory analysis of BTEX, PHC Fractions 1 through 4, metals and detailed salinity; and
- Prepared a report documenting the field observations and the analytical results.



3.0 SITE DESCRIPTION

3.1 Location and Development Details

Location of Site: Rainbow Valley Road beneath the Whitemud Drive overpass
Edmonton, Alberta

LSD: 14-12-052-25-W4M

Current Owner: The City of Edmonton

3.2 Physical Description

The Site is located in Rainbow Valley in Edmonton, Alberta and is currently under A Zoning (Metropolitan Recreation Zone). *The purpose of this zone is to preserve natural areas and parkland along the river, creeks, ravines and other designated areas for active and passive recreational uses and environmental protection in conformance with Plan Edmonton and the North Saskatchewan River Valley Area Redevelopment Plan (City of Edmonton Zoning Bylaw 12800).* At the time of the investigation, the Site consisted of natural parkland.

The Site was accessed from a gravel-surfaced parking lot to the north, which was adjacent to the south side of Rainbow Valley Road. The remaining surrounding area consisted of natural parkland, also within the Metropolitan Recreation Zone. Whitemud Creek, a tributary of the North Saskatchewan River, was located to the south and east of the Site.

3.3 Topography and Drainage

The local topography sloped to the south and east toward Whitemud Creek. Surface drainage at the Site is anticipated to be either through infiltration or overland flow toward Whitemud Creek. No standing water was observed on the Site at the time of the investigation.



4.0 METHODOLOGY

4.1 Hazard Assessment and Utility Locations

Prior to completing any field work on the Site, Nichols Environmental completed a site-specific health and safety plan and hazard assessment. Included in the health and safety plan were requirements for personal protective equipment (PPE), an emergency contact section for situations where workers may require medical attention, and protocols for working around heavy equipment, traffic, and near open water. A ground disturbance protocol to identify all potential buried underground utilities and structures was also put in place.

An emergency Alberta One-Call (ticket number 201664108218) was placed on October 6, 2016 and 3-D Line Locating (2011) Ltd. of Nisku, Alberta was retained on October 7, 2016 to identify private utilities within the work area as well as confirm any utilities that may have been identified by Alberta One-Call.

No privately or publicly owned utilities were identified for the Site.

4.2 Landfill Application

A composite sample (LF-01), considered representative of the impacted soils to be removed, was collected by Nichols Environmental on October 6, 2016 and submitted for laboratory analysis. The results of the analyses are presented on Table 1 and indicate that the soils would be considered suitable for disposal at a Class II Landfill, or equivalent.

Nichols Environmental submitted an application to dispose of the soils to MCL Waste Systems on October 11, 2016. Authorization from MCL Waste Systems was received on October 12, 2016 under special waste approval number LL20161012-3195HC.

4.3 Excavation

Nichols Environmental retained the services of Gene's Excavating & Bobcat Services Ltd., of Leduc, Alberta to provide the necessary personnel and equipment to excavate the impacted soils. The initial excavation work was completed on October 7, 2016 with the excavated impacted soil being contained on Site in a poly-lined cell until such time that landfill approval was granted. On October 12, 2016, rig matting was delivered to Site and placed by Indent Oilfield Trucking Ltd. The rig matting was required to facilitate safe access for haul trucks during loading and to limit the potential damage to the ground surface in the non-impacted areas of the Site. The impacted soil was removed from the Site on October 13, 2016 and the rig matting was removed on October 15, 2016. Following receipt of the initial soil closure analytical results, a small volume of impacted soil was identified and subsequently removed from the Site on October 21, 2016.



The final excavation measured approximately 25 by 15 m in size and ranged in depth from 0.05 to 1.8 m. A total of 152.26 t of soil was excavated and disposed of at the MCL Waste Systems Class II landfill near Leduc, Alberta. A summary report for the landfill tonnage is provided in Appendix C.

4.4 Soil Sampling Program

Soil samples were collected on a 5-m grid pattern throughout the excavation. Soil samples were collected from the seepage pit every 0.5 m vertically along each of the side walls and at the base. All soil samples were field screened for organic vapour concentrations (OVCs), and were prepared for potential laboratory analyses. Samples collected for OVC analysis were placed in large disposable sample bags and sealed with approximately 50% vapour headspace. The OVCs were measured after the samples reached an ambient temperature (approximately 20°C) with a MiniRae™ photo-ionization device (PID). The PID was calibrated following protocols outlined by MiniRae™ using a known standard. Duplicate soil samples collected for potential laboratory analyses were placed into 120-mL glass jars which were filled to capacity with soil and fitted with screw-down, Teflon™-lined lids. All samples were kept on ice in a cooler to moderate temperature fluctuations prior to delivery to the laboratory.

The field protocols and QA/QC procedures utilized by Nichols Environmental were in accordance with standard industry protocols and all samples were transported under chain of custody protocols. Exova conducted all soil and surface water laboratory analyses.

Detailed sampling methodology is presented in Appendix D and sampling locations are presented on Figure 2 and results of the soil sampling program are further discussed in Section 6.1.

4.5 Site Restoration

Final restoration and backfilling of the Site were completed on October 21 and 25, 2016. Prior to this, silt fencing was installed downgradient and surrounding the excavated area on October 12, 2016. The silt fencing was installed to prevent potential sediment migration off-site and downgradient into Whitemud Creek.

The seepage pit was reconstructed as per specifications provided by The City of Edmonton Engineering Services Section. The seepage pit was expanded to accommodate a 1:1 side slope for each of the four side walls. A non-woven geotextile (LP 4.5) provided by Layfield Canada Ltd. was placed at the bottom of the seepage pit, after which the seepage pit was backfilled with 40 t of class 1 riprap supplied by The City of Edmonton.



The remainder of the Site was backfilled with topsoil which was provided by Gene's Excavating & Bobcat Services Ltd. A composite sample of the backfill (BF-01) was collected and submitted by Nichols Environmental for laboratory analysis of petroleum hydrocarbons, metals and salinity, which confirmed that the material was suitable for backfilling the excavation. The results from the backfill analyses are discussed further in Section 6.1.4.

Topsoil was track-packed following placement throughout the remainder of the Site. The area was then re-seeded on October 25, 2016 using a custom native reclamation mix provided by Brett Young. The seed mix was broadcast-spread throughout the Site and consisted of 15% Northern Wheatgrass, 20% Slender Wheatgrass, 20% Nodding Brome Grass, 7.5% Tufted Hair Grass, 7.5% Tickle Grass, 10% Sloughgrass, 10% Sandburg Bluegrass and 10% Annual Ryegrass. Following seeding, erosion control blankets (LPC-2: coconut matting) supplied by Layfield Canada Ltd. were intimately secured to the compacted topsoil surface material.

4.6 Survey

The City of Edmonton Engineering Services - Transportation Branch (survey office) completed a survey of the Site, for which the details and CAD files were provided to Nichols Environmental. Based on the survey, the impacted/remediated area was 392.1 m².

4.7 Surface Water Sampling

Whitemud Creek was located approximately 15 m downgradient of the Site. Nichols Environmental assessed the stream for visible evidence of hydrocarbon sheens throughout the duration of the Spill Response and Remediation Program, but none were observed. A surface water sample was collected from Whitemud Creek on October 6, 2016 during the initial response and again on October 7, 2016 following the Site remediation. The results of the surface water sampling program are further discussed in Section 6.2.



5.0 ASSESSMENT GUIDELINES

5.1 Regulatory Framework

The analytical results for the Site are presented and discussed in context of the *Alberta Tier 1 and 2 Soil and Groundwater Remediation Guidelines*, as amended up to February 2016 (2016 Alberta Guidelines).

Under these guidelines, three management options are provided: Tier 1, Tier 2, and Exposure Control. Tier 1 guidelines are considered applicable for the majority of the sites in Alberta and are somewhat conservative as they have been developed for protection of the more sensitive land uses. Tier 2 guidelines allow for consideration of site-specific conditions through the modification of Tier 1 guidelines and/or by removing exposure pathways that may not be applicable to the site. The Tier 2 approach still provides the same level of protection to human and ecological receptor pathways as the Tier 1 approach, but must be done through the collection of more site-specific data. Exposure Control involves risk management through exposure barriers or administrative controls based on a site-specific risk management approach.

The above remediation criteria may be used as benchmarks to evaluate the need for further investigation, remediation or to guide in the establishment of land-use restrictions.

Surface soil guidelines for BTEX and PHC Fractions 1 through 4 must be applied up to and including a depth of 3.0 mbg. Subsoil guidelines for BTEX and PHC Fractions 1 through 4 must be applied below the depth of 3.0 mbg. The Tier 1 approach also allows the exclusion of the ecological direct soil contact pathway for soil and groundwater for PHC Fractions 1 through 4 for any land use below a depth of 3.0 mbg, while all other exposure pathways apply.

In some cases, a contaminated site may be located adjacent to a more sensitive land-use. In such instances, the guidelines for the more sensitive land-use would be considered applicable to the contaminated site within a 30-m buffer zone from the more sensitive land-use boundary. This is done as a means to protect receptors of the more sensitive land-use, specifically the vapour inhalation and groundwater direct ecological contact pathways.

The surface water sample results are presented and discussed in context of Alberta's *Environmental Quality Guidelines for Alberta Surface Waters*, released July 2014 (2014 Alberta EQS).

Surface water quality guidelines have been developed for the protection of aquatic life, agriculture, recreation, sediment quality, and tissue residue. The guidelines are either numerical concentrations or narrative statements that have been recommended to support and maintain a designated water use and have been compiled from new and previous provincial guidelines, federal



(Canadian Council of Ministers of the Environment - CCME) guidelines, from US Environmental Protection Agency (USEPA) criteria, and other provincial jurisdictions.

5.2 Land Use Assessment

The Site is situated within an area of natural parkland and furthermore is zoned for parkland land use (Metropolitan Recreation Zone) by The City of Edmonton.

The 2016 Alberta Guidelines have remediation criteria for both coarse and fine-grained soil. One soil sample was collected and submitted for grain-size analyses: SA-12 at 0.05 mbg (17.9% retained in a 75- μ m sieve) was reported as being fine grained.

The closest water body to the Site is Whitemud Creek, which is situated approximately 15 m to the south and east.

5.3 Water Well Search

A potable water well search was conducted through the AEP Groundwater Information System to identify any water wells that are in the area. The search was completed within a 0.5-km radius of the Site, and there were no potable water wells identified within this radius.

5.4 Parameter Assessment

Based on the land-use assessment and grain-size analyses, the 2016 Alberta Tier 1 Soil and Groundwater Natural Area Land Use Guidelines for fine-grained soils would be considered applicable to the Site at this time, as well as the 2014 Environmental Quality Guidelines for Alberta Surface Waters with the protection of aquatic life pathway being applicable.



6.0 FIELD AND ANALYTICAL RESULTS

6.1 Soil Results

6.1.1 Organic Vapour Concentrations

In total, 38 samples were collected and field screened for OVCs during the soil sampling program. Of these samples, seven were found to be impacted and were subsequently removed from the excavation (intermediate samples). Samples Resp-01 and Resp-02 were collected during the initial spill response on October 6, 2016, while the remainder of the samples (SA-01 through SA-36) were collected during the course of the spill remediation. The results of the field screening are presented in Table 2.

Intermediate soil OVCs ranged from 5.5 parts per million by volume (ppmv) in SA-23 at 0.15 mbg to 190.2 ppmv in Resp-01 at 0.05 mbg.

In total, 30 final soil samples were field screened for OVCs. Final soil OVCs ranged from 0.7 ppmv in SA-07 at 0.05 mbg to 6.7 ppmv in SA-27 at 0.05 mbg.

6.1.2 Petroleum Hydrocarbons

Seven soil samples were collected and submitted for laboratory analysis of BTEX and PHC Fractions 1 through 4 based on field observations and OVC readings. Of these samples, Resp-01 (initial response sample collected on October 6, 2016) was deemed to be impacted with BTEX and PHC Fractions 1 through 3 and was subsequently removed from the excavation. BTEX and PHC Fractions 1 through 4 concentrations in all remaining closure samples were below their respective guidelines. The analytical results are presented in Table 3 and on Figure 3.

6.1.3 Polycyclic Aromatic Hydrocarbons

Eleven soil samples were collected and submitted for laboratory analysis of PAHs. Of these samples, four were deemed to be impacted and were subsequently removed from the excavation. PAH concentrations in all remaining closure samples were below their respective guidelines. The analytical results are presented in Table 4 and on Figure 4.

6.1.4 Backfill Characterization

A composite sample of the backfill (BF-02) was collected and submitted for laboratory analysis of petroleum hydrocarbons, metals and salinity. The analytical results are presented in Table 5 and are summarized below:



- BTEX and PHC Fractions 1 through 4 concentrations were below their respective guidelines;
- All metal parameter concentrations were below their respective guidelines;
- Soil EC was 0.82 deciSiemens per metre (dS/m), which was below the acceptable guideline limit based on natural area land use;
- Soil sodium adsorption ratio (SAR) was 0.3, which was below the acceptable guideline limit based on natural area land use; and
- pH was 6.2 which was within the guideline range of 6 to 8.5.

A copy of the final signed soil laboratory reports is included in Appendix E.

6.2 Surface Water Sampling Results

6.2.1 Petroleum Hydrocarbons

Two surface water samples were collected and submitted for laboratory analysis of BTEX and PHC Fractions 1 through 3+. The analytical results are presented in Table 6 and on Figure 5. All of the analysed parameter concentrations for both samples were below their respective recommended guidelines.

6.2.2 Polycyclic Aromatic Hydrocarbons

Two surface water samples were collected and submitted for laboratory analysis of PAHs. The analytical results are presented in Table 7 and on Figure 5. All of the analysed parameter concentrations for both samples were below their respective recommended guidelines.

A copy of the final signed surface water laboratory report is included in Appendix E.



7.0 CONCLUSIONS AND RECOMMENDATIONS

Nichols Environmental has completed a Spill Response and Remediation Program for the Site located adjacent to Rainbow Valley Road beneath the Whitemud Drive overpass in Edmonton, Alberta. The field and analytical results are summarized as follows:

- On October 5, 2016, a gravel truck travelling westbound on Whitemud Drive struck a bucket lift. The gravel truck caught fire and released an unknown volume of diesel fuel. The City of Edmonton Fire Rescue Services were on the scene to extinguish the fire, resulting in an undetermined volume of firefighting material and diesel fuel ('impacted water') running down the road surface and discharging through a drainage culvert to the parkland area below the Whitemud Drive overpass, adjacent to Rainbow Valley Road. A seepage pit was previously constructed directly below the drainage culvert, which subsequently overflowed with impacted water migrating overland and downgradient toward Whitemud Creek. The incident was reported to AEP on October 9, 2016 and is registered as AEP File No. 316940;
- Nichols Environmental retained third-party contractors to provide the necessary personnel and equipment to complete the remediation. The remedial excavation was completed by October 21, 2016 and the final excavation measured approximately 25 by 15 m in size and ranged in depth from 0.05 to 1.8 m. A total of 152.26 t of soil was excavated and disposed of at the MCL Waste Systems Class II landfill near Leduc, Alberta. Backfilling of the excavation and overall site restoration were completed on October 21 and 25, 2016;
- All soil analytical results were compared to the 2016 Alberta Tier 1 Guidelines for Natural Area Land Use using fine-grained criteria, while surface water analytical results were compared to the 2014 Environmental Quality Guidelines for Alberta Surface Waters with the protection of aquatic life pathway being applicable;
- The results of the soil sampling program indicated that all closure samples had both PHC and PAH concentrations that were below their applicable guidelines; and
- The results of the surface water sampling program indicated that all surface water samples had both PHC and PAH concentrations below their applicable guidelines.

Overall, the results of the Spill Response and Remediation Program indicate that PHC and PAH concentrations were below the recommended guidelines at the locations tested for both soil and surface water. Nichols Environmental has no further recommendations for additional assessment or remediation at this time as it relates to this specific incident.



8.0 REFERENCES

Throughout this project, the following resources were used:

- Alberta Environment and Parks (AEP). 2016. Alberta Tier 1 Soil and Groundwater Remediation Guidelines. Land and Forestry Policy Branch, Policy Division;
- Alberta Environment and Parks (AEP). Alberta Water Well Information Database: <http://www.environment.alberta.ca/01314.html>;
- Alberta One-Call;
- 3-D Line Locating (2011) Ltd.; and
- The City of Edmonton Maps, Zoning Detail: <http://maps.edmonton.ca/>.



9.0 QUALIFICATIONS AND LIMITATIONS

9.1 Qualifications

Mr. Michael Harquail, A.T.T., coordinated all aspects of the field program. Mr. Harquail has an Environmental Assessment and Restoration Diploma from Lethbridge College.

Mr. Barry Rakewich, P.Ag., EP, provided project management and peer review of the entire project and completion of the final report. Mr. Rakewich has more than 15 years of consulting and industry experience.

Mr. Rob Dickie, P.Geol., R.E.T., EP, provided the senior project management and peer review of the entire project. Mr. Dickie has more than 30 years of consulting and industry experience.

9.2 Limitations

In conducting the Spill Response and Remediation Program at the Site and in rendering our conclusions on the potential presence or level of contamination, Nichols Environmental (Canada) Ltd. gives the benefit of its best judgment based on its experience and in accordance with generally accepted professional standards for this type of investigation. Our conclusions are limited by the following:

- Nichols Environmental spent only a limited amount of time on the Site. Thus, any activities conducted on the Site following the site inspection that Nichols Environmental is not aware of may have an impact on the conclusions and recommendations presented;
- The sampling areas were limited to the sample locations outlined on Figures 2 through 4; and
- It was not possible to test for all forms of contamination at each and every location in the study areas. Although site-specific locations were used during testing, it is our opinion that the information obtained is representative of the conditions at the time the assessment was conducted.

This report is intended to provide information to reduce, but not necessarily eliminate, uncertainty regarding the potential for contamination of a property. This report has been prepared for the exclusive use of The City of Edmonton for the purpose of assessing the current environmental conditions that may be present at the Site. Any uses which a third party makes of this report, or any reliance on or decisions made based on it, are the responsibility of such third parties. Nichols Environmental (Canada) Ltd. accepts no responsibility for damages, if any, suffered by any third party as a result of decisions made or actions based on this report.



10.0 CLOSURE

We trust this meets with your current requirements. Should you have any questions or concerns, please contact the undersigned at your convenience.

Yours truly,

NICHOLS ENVIRONMENTAL (CANADA) LTD.

APEGA PERMIT TO PRACTICE NO. P6730

A handwritten signature in black ink, appearing to read 'Barry Rakewich', written over a light grey rectangular background.

Barry Rakewich, P.Ag., EP
General Manager - Environmental

Reviewed by:

A very faint, dotted signature of R.W. (Rob) Dickie, appearing as a light grey pattern of dots.

12Dec16
R.W. (Rob) Dickie, P.Geol., R.E.T., EP
President

Distribution

PDF

aaron.lewicki@edmonton.ca

Aaron Lewicki

FIGURES

Hi Tara, Heather,

As discussed, we reached out to our engineering services group to find additional information regarding the fire incident on Rainbow Valley Bridges. Apparently remediation was completed, which is documented in the attached report. Based on our engineering service group's opinion, I believe there is no further action needed to address this APEC, however, I would ask that you review and the review at a high level to validate Engineering service's opinion. Please also include the report as part of the Phase 1 EIA.

Thanks,

----- Forwarded message -----

From: Paul Fuellbrandt <paul.fuellbrandt@edmonton.ca>

Date: Fri, Jul 10, 2020 at 2:59 PM

Subject: Follow up from meeting re: Diesel Cleanup

To: Christopher Wintle <christopher.wintle@edmonton.ca>, Isaac Rodriguez <isaac.rodriguez@edmonton.ca>

Hi Christopher and Isaac,

Attached is the report from Nichols. The remediation was completed however there was no analysis done for any PFAS compounds. These would be present in the firefighting foam. This could be due to a couple of reasons:

1. PFAS are an emerging group of contaminants. We have only started looking for them in the last couple of years; and
2. There is no provincial guideline for them so there is no rule of law to follow.

Chances are that the PFAS was cleaned up along with the hydrocarbons so the risk of remaining contamination is low.

Let me know if you have any questions or need additional information from me.

Like I said, we are happy to help with assessing the area for salinity to determine disposal, reuse, and uncontaminated sub-areas within the project boundaries for you. Let me know if you want assistance with that when the time comes.

Best,



Paul Fuellbrandt

Environmental Scientist, Engineering Services
Integrated Infrastructure Services | Business Planning and Support

780-944-5341 OFFICE
780-819-5888 MOBILE

City of Edmonton
[11004 190 Street NW](#)
[Edmonton AB T5S 0G9](#)

All information contained in this email post is proprietary to the City of Edmonton, confidential and intended only for the addressed recipient. If you have received this post in error, please disregard the contents, inform the sender of the misdirection, and remove it from your system. The copying, dissemination or distribution of this email, if misdirected, is strictly prohibited.



Christopher Wintle, P.Eng.

Program Manager
Transportation Planning & Design
Integrated Infrastructure Services | Infrastructure Planning & Design

780-496-1792 OFFICE

All information contained in this email post is proprietary to the City of Edmonton, confidential and intended only for the addressed recipient. If you have received this post in error, please disregard the contents, inform the sender of the misdirection, and remove it from your system. The copying, dissemination or distribution of this email, if misdirected, is strictly prohibited.

12th Floor, Edmonton Tower
10111-104 Avenue NW Edmonton
T5J 0J4

The contents of this message and any attachment(s) are confidential, proprietary to the City of Edmonton, and are intended only for the addressed recipient. If you have received this in error, please disregard the contents, inform the sender of the misdirection, and remove it from your system. The copying, dissemination, or distribution of this message, if misdirected, is strictly prohibited.

Reference image scale 1:55,000

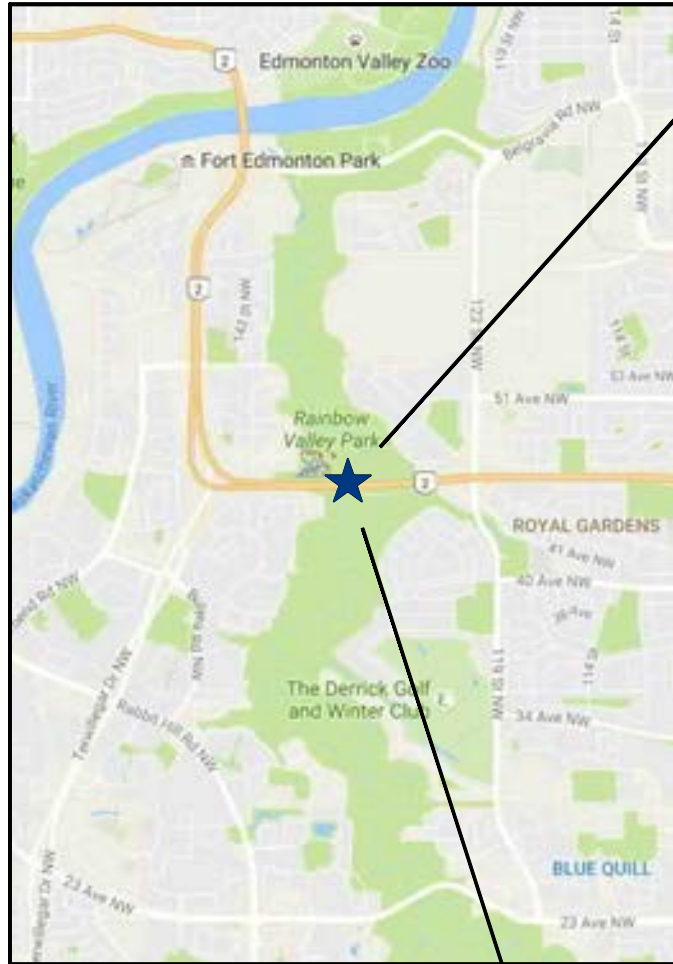

Legend:

Excavation Area

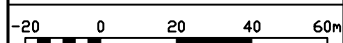

CLIENT	 The City of Edmonton
PROJECT	Spill Response and Remediation Program Rainbow Valley Road Beneath Whitemud Drive Edmonton, Alberta
DRAWING TITLE	Site Location and Surrounding Land Use
BASE/SITE PLAN PROVIDED BY	Nichols Environmental (Canada) Ltd.
REVISION DATE	December 2016
SCALE	APPROVED
1:2,000	MAH/LL
PROJECT NO.	16-442-CRV
DRAWING NO.	Figure 1

2015 Air Photo Source: Google Earth

J:\2016\16-442-CRV\Drawings\16-442-CRV.dwg Original drawing in colour. Black and white copies may not interpret properly.

- Legend:
- SA-01 Sample
 - Resp-01 Initial Response Sample
 - Excavation Area
 - Grass
 - Trees/Shrubs



NICHOLS ENVIRONMENTAL (CANADA) LTD.

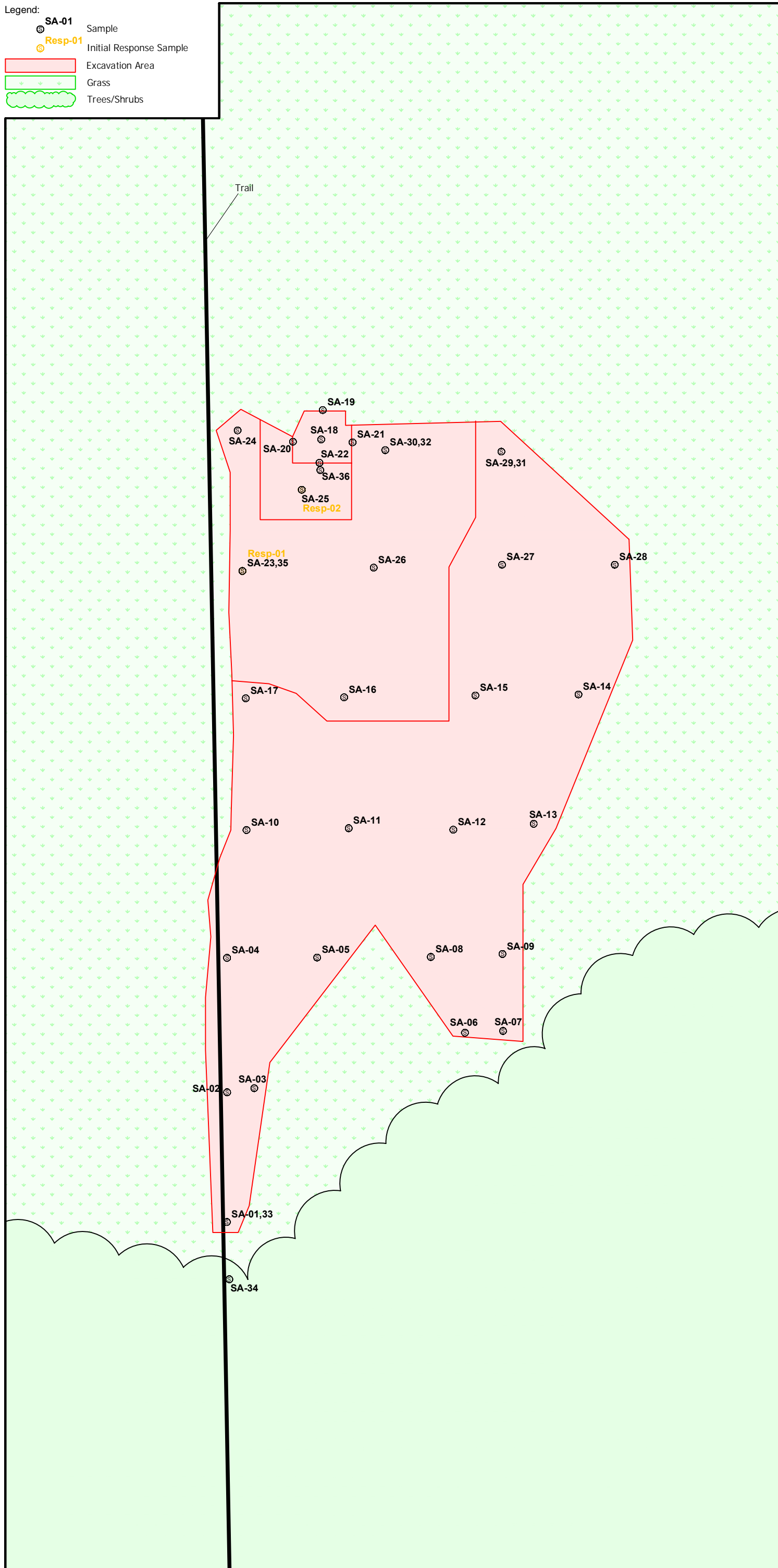

J:\2016\16-442-CRV\Drawings\16-442-CRV.dwg Original drawing in colour. Black and white copies may not interpret properly.

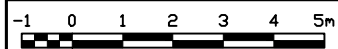

CLIENT	
 The City of Edmonton	
PROJECT	
Spill Response and Remediation Program Rainbow Valley Road Beneath Whitemud Drive Edmonton, Alberta	
DRAWING TITLE	
Site Detail and Sample Locations	
BASE/SITE PLAN PROVIDED BY	
Nichols Environmental (Canada) Ltd.	
REVISION DATE	
December 2016	
SCALE	APPROVED
1:150	MAH/LL
PROJECT NO.	
16-442-CRV	
DRAWING NO.	
Figure 2	

- Legend:
- SA-01 Sample
 - Resp-01 Initial Response Sample
 - Excavation Area
 - Grass
 - Trees/Shrubs
 - Exceeds Guidelines
 - Below Guidelines



NICHOLS ENVIRONMENTAL (CANADA) LTD.

2016 Alberta Tier 1 Guidelines	
Surface Soil	
Benzene	0.046
Toluene	0.52
Ethylbenzene	0.073
Xylenes	0.99
Fraction 1	210
Fraction 2	150
Fraction 3	1,300
Fraction 4	5,600

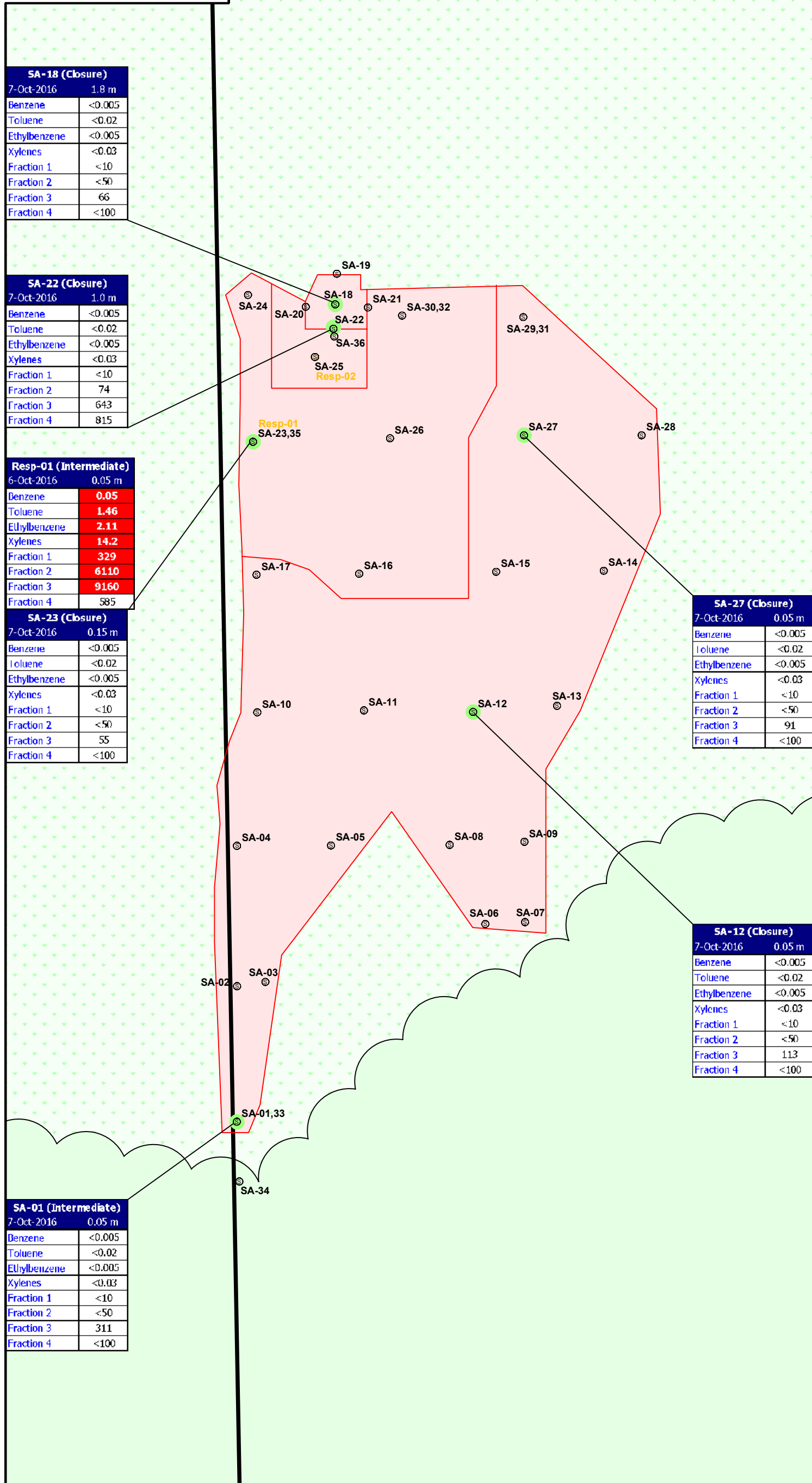

SA-18 (Closure)	
7-Oct-2016	1.8 m
Benzene	<0.005
Toluene	<0.02
Ethylbenzene	<0.005
Xylenes	<0.03
Fraction 1	<10
Fraction 2	<50
Fraction 3	66
Fraction 4	<100

SA-22 (Closure)	
7-Oct-2016	1.0 m
Benzene	<0.005
Toluene	<0.02
Ethylbenzene	<0.005
Xylenes	<0.03
Fraction 1	<10
Fraction 2	74
Fraction 3	643
Fraction 4	815

Resp-01 (Intermediate)	
6-Oct-2016	0.05 m
Benzene	0.05
Toluene	1.46
Ethylbenzene	2.11
Xylenes	14.2
Fraction 1	329
Fraction 2	6110
Fraction 3	9160
Fraction 4	585

SA-23 (Closure)	
7-Oct-2016	0.15 m
Benzene	<0.005
Toluene	<0.02
Ethylbenzene	<0.005
Xylenes	<0.03
Fraction 1	<10
Fraction 2	<50
Fraction 3	55
Fraction 4	<100

SA-27 (Closure)	
7-Oct-2016	0.05 m
Benzene	<0.005
Toluene	<0.02
Ethylbenzene	<0.005
Xylenes	<0.03
Fraction 1	<10
Fraction 2	<50
Fraction 3	91
Fraction 4	<100

SA-12 (Closure)	
7-Oct-2016	0.05 m
Benzene	<0.005
Toluene	<0.02
Ethylbenzene	<0.005
Xylenes	<0.03
Fraction 1	<10
Fraction 2	<50
Fraction 3	113
Fraction 4	<100

SA-01 (Intermediate)	
7-Oct-2016	0.05 m
Benzene	<0.005
Toluene	<0.02
Ethylbenzene	<0.005
Xylenes	<0.03
Fraction 1	<10
Fraction 2	<50
Fraction 3	311
Fraction 4	<100

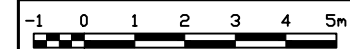

CLIENT

 The City of Edmonton

PROJECT
 Spill Response and Remediation Program
 Rainbow Valley Road Beneath
 Whitemud Drive
 Edmonton, Alberta

DRAWING TITLE
 Soil Petroleum Hydrocarbon Data

BASE/SITE PLAN PROVIDED BY
 Nichols Environmental (Canada) Ltd.

REVISION DATE
 December 2016

SCALE
 1:150

APPROVED
 MAH/LL

PROJECT NO.
 16-442-CRV

DRAWING NO.
 Figure 3

J:\2016\16-442-CRV Drawings\16-442-CRV.dwg Original drawing in colour. Black and white copies may not interpret properly.

- Legend:
- SA-01 Sample
 - Resp-01 Initial Response Sample
 - Excavation Area
 - Grass
 - Trees/Shrubs
 - Exceeds Guidelines
 - Below Guidelines

SA-22 (Intermediate)		SA-36 (Closure)	
7-Oct-2016	1.0 m	21-Oct-2016	1.0 m
Acenaphthene	<0.05	Acenaphthene	<0.05
Acenaphthylene	<0.05	Acenaphthylene	<0.05
Anthracene	0.018	Anthracene	<0.003
Fluoranthene	0.06	Fluoranthene	<0.01
Fluorene	0.13	Fluorene	<0.05
Naphthalene	0.036	Naphthalene	<0.010
Phenanthrene	0.44	Phenanthrene	<0.01
Pyrene	0.12	Pyrene	<0.01
IACR (Coarse)	0.02	IACR (Coarse)	<0.001
IACR (Fine)	0.04	IACR (Fine)	<0.001
Benzo(a)anthracene	0.03	Benzo(a)anthracene	<0.01
Benzo(a)pyrene	<0.05	Benzo(a)pyrene	<0.05
Benzo(b+j)fluoranthene	<0.05	Benzo(b+j)fluoranthene	<0.05
Benzo(g,h,i)perylene	<0.05	Benzo(g,h,i)perylene	<0.05
Benzo(k)fluoranthene	<0.05	Benzo(k)fluoranthene	<0.05
Chrysene	0.05	Chrysene	<0.05
Dibenzo(a,h)anthracene	<0.05	Dibenzo(a,h)anthracene	<0.05
Indeno(1,2,3-c,d)pyrene	<0.05	Indeno(1,2,3-c,d)pyrene	<0.05

Resp-01 (Intermediate)	
6-Oct-2016	0.05 m
Acenaphthene	0.47
Acenaphthylene	<0.05
Anthracene	<0.003
Fluoranthene	0.09
Fluorene	1.59
Naphthalene	1.54
Phenanthrene	1
Pyrene	0.35
IACR (Coarse)	0.028
IACR (Fine)	0.055
Benzo(a)anthracene	0.03
Benzo(a)pyrene	<0.05
Benzo(b+j)fluoranthene	<0.05
Benzo(g,h,i)perylene	<0.05
Benzo(k)fluoranthene	<0.05
Chrysene	0.06
Dibenzo(a,h)anthracene	<0.05
Indeno(1,2,3-c,d)pyrene	<0.05

SA-23 (Intermediate)	
7-Oct-2016	0.15 m
Acenaphthene	<0.05
Acenaphthylene	<0.05
Anthracene	<0.003
Fluoranthene	<0.01
Fluorene	<0.05
Naphthalene	0.019
Phenanthrene	0.02
Pyrene	<0.01
IACR (Coarse)	<0.001
IACR (Fine)	<0.001
Benzo(a)anthracene	<0.01
Benzo(a)pyrene	<0.05
Benzo(b+j)fluoranthene	<0.05
Benzo(g,h,i)perylene	<0.05
Benzo(k)fluoranthene	<0.05
Chrysene	<0.05
Dibenzo(a,h)anthracene	<0.05
Indeno(1,2,3-c,d)pyrene	<0.05

SA-35 (Closure)	
21-Oct-2016	0.30 m
Acenaphthene	<0.05
Acenaphthylene	<0.05
Anthracene	<0.003
Fluoranthene	<0.01
Fluorene	<0.05
Naphthalene	<0.010
Phenanthrene	<0.01
Pyrene	<0.01
IACR (Coarse)	<0.001
IACR (Fine)	<0.001
Benzo(a)anthracene	<0.01
Benzo(a)pyrene	<0.05
Benzo(b+j)fluoranthene	<0.05
Benzo(g,h,i)perylene	<0.05
Benzo(k)fluoranthene	<0.05
Chrysene	<0.05
Dibenzo(a,h)anthracene	<0.05
Indeno(1,2,3-c,d)pyrene	<0.05

SA-34 (Closure)	
21-Oct-2016	0.05 m
Acenaphthene	<0.05
Acenaphthylene	<0.05
Anthracene	<0.003
Fluoranthene	<0.01
Fluorene	<0.05
Naphthalene	<0.010
Phenanthrene	<0.01
Pyrene	<0.01
IACR (Coarse)	<0.001
IACR (Fine)	<0.001
Benzo(a)anthracene	<0.01
Benzo(a)pyrene	<0.05
Benzo(b+j)fluoranthene	<0.05
Benzo(g,h,i)perylene	<0.05
Benzo(k)fluoranthene	<0.05
Chrysene	<0.05
Dibenzo(a,h)anthracene	<0.05
Indeno(1,2,3-c,d)pyrene	<0.05

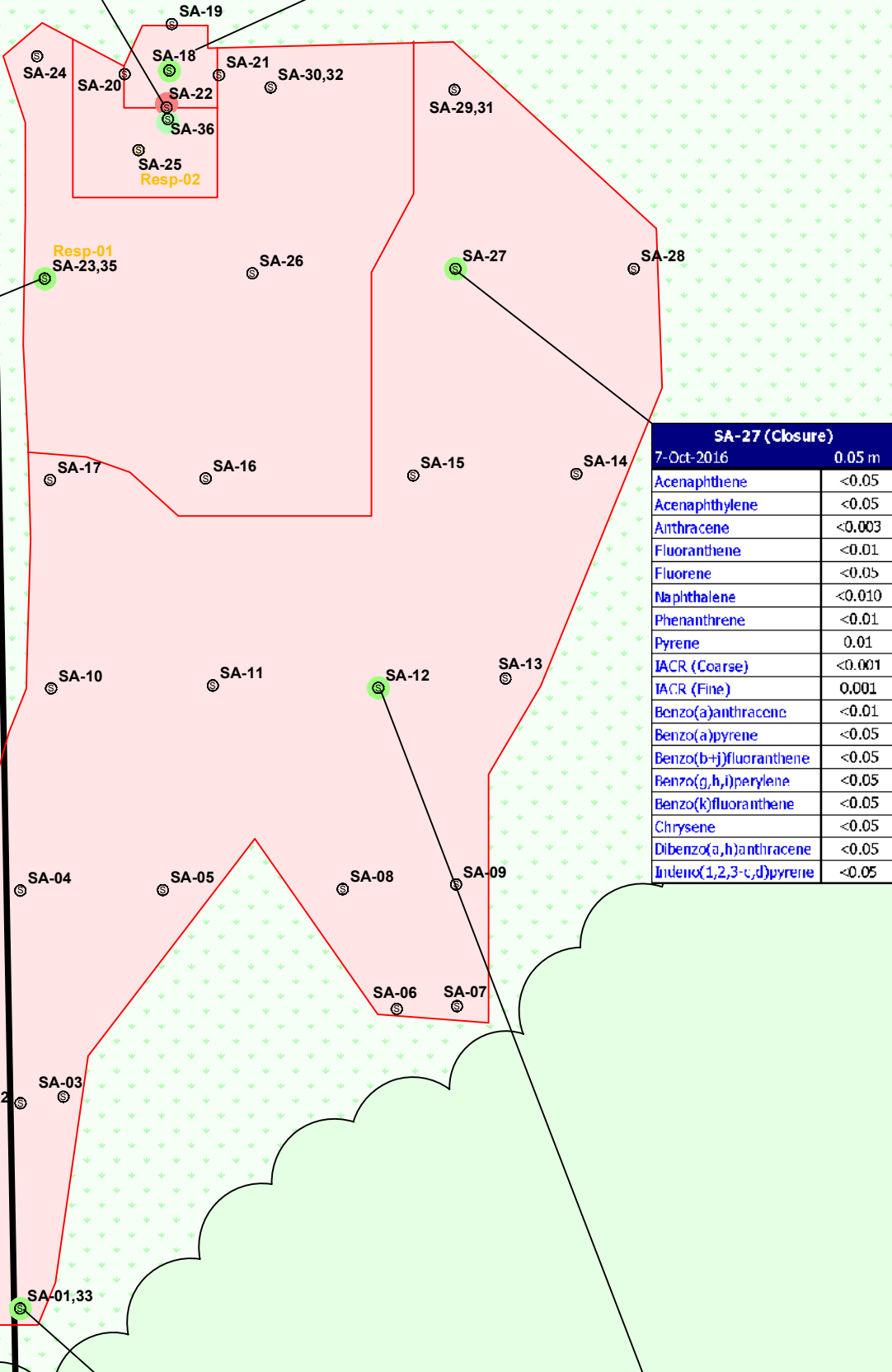

SA-01 (Intermediate)		SA-33 (Closure)	
7-Oct-2016	0.05 m	21-Oct-2016	0.15 m
Acenaphthene	<0.05	Acenaphthene	<0.05
Acenaphthylene	<0.05	Acenaphthylene	<0.05
Anthracene	0.009	Anthracene	<0.003
Fluoranthene	0.07	Fluoranthene	<0.01
Fluorene	<0.05	Fluorene	<0.05
Naphthalene	<0.010	Naphthalene	<0.010
Phenanthrene	0.03	Phenanthrene	<0.01
Pyrene	0.07	Pyrene	<0.01
IACR (Coarse)	0.017	IACR (Coarse)	<0.001
IACR (Fine)	0.032	IACR (Fine)	<0.001
Benzo(a)anthracene	0.03	Benzo(a)anthracene	<0.01
Benzo(a)pyrene	<0.05	Benzo(a)pyrene	<0.05
Benzo(b+j)fluoranthene	<0.05	Benzo(b+j)fluoranthene	<0.05
Benzo(g,h,i)perylene	<0.05	Benzo(g,h,i)perylene	<0.05
Benzo(k)fluoranthene	<0.05	Benzo(k)fluoranthene	<0.05
Chrysene	<0.05	Chrysene	<0.05
Dibenzo(a,h)anthracene	<0.05	Dibenzo(a,h)anthracene	<0.05
Indeno(1,2,3-c,d)pyrene	<0.05	Indeno(1,2,3-c,d)pyrene	<0.05

SA-12 (Closure)	
7-Oct-2016	0.05 m
Acenaphthene	<0.05
Acenaphthylene	<0.05
Anthracene	<0.003
Fluoranthene	0.01
Fluorene	<0.05
Naphthalene	<0.010
Phenanthrene	0.01
Pyrene	<0.01
IACR (Coarse)	<0.001
IACR (Fine)	<0.001
Benzo(a)anthracene	<0.01
Benzo(a)pyrene	<0.05
Benzo(b+j)fluoranthene	<0.05
Benzo(g,h,i)perylene	<0.05
Benzo(k)fluoranthene	<0.05
Chrysene	<0.05
Dibenzo(a,h)anthracene	<0.05
Indeno(1,2,3-c,d)pyrene	<0.05

SA-27 (Closure)	
7-Oct-2016	0.05 m
Acenaphthene	<0.05
Acenaphthylene	<0.05
Anthracene	<0.003
Fluoranthene	<0.01
Fluorene	<0.05
Naphthalene	<0.010
Phenanthrene	<0.01
Pyrene	0.01
IACR (Coarse)	<0.001
IACR (Fine)	0.001
Benzo(a)anthracene	<0.01
Benzo(a)pyrene	<0.05
Benzo(b+j)fluoranthene	<0.05
Benzo(g,h,i)perylene	<0.05
Benzo(k)fluoranthene	<0.05
Chrysene	<0.05
Dibenzo(a,h)anthracene	<0.05
Indeno(1,2,3-c,d)pyrene	<0.05



NICHOLS ENVIRONMENTAL (CANADA) LTD.

2016 Alberta Tier 1 Guidelines

Acenaphthene	0.32
Acenaphthylene	-
Anthracene	0.0046
Fluoranthene	0.032
Fluorene	0.29
Naphthalene	0.014
Phenanthrene	0.051
Pyrene	0.034
Carcinogenic PAHs	
IACR (Coarse)	<1.0
IACR (Fine)	<1.0
Benzo(a)anthracene	0.07
Benzo(a)pyrene	0.6
Benzo(b+j)fluoranthene	6.2
Benzo(g,h,i)perylene	-
Benzo(k)fluoranthene	6.2
Chrysene	6
Dibenzo(a,h)anthracene	-
Indeno(1,2,3-c,d)pyrene	-

J:\2016\16-442-CRV Drawings\16-442-CRV.dwg Original drawing in colour. Black and white copies may not interpret properly.

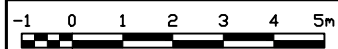

CLIENT	The City of Edmonton	
PROJECT	Spill Response and Remediation Program Rainbow Valley Road Beneath Whitemud Drive Edmonton, Alberta	
DRAWING TITLE	Soil Polycyclic Aromatic Hydrocarbon Data	
BASE/SITE PLAN PROVIDED BY	Nichols Environmental (Canada) Ltd.	
REVISION DATE	December 2016	
SCALE	1:150	APPROVED MAH/LL
PROJECT NO.	16-442-CRV	
DRAWING NO.	Figure 4	

Legend:

- Excavation Area
- Surface Water Sample
- Exceeds Guidelines
- Below Guidelines

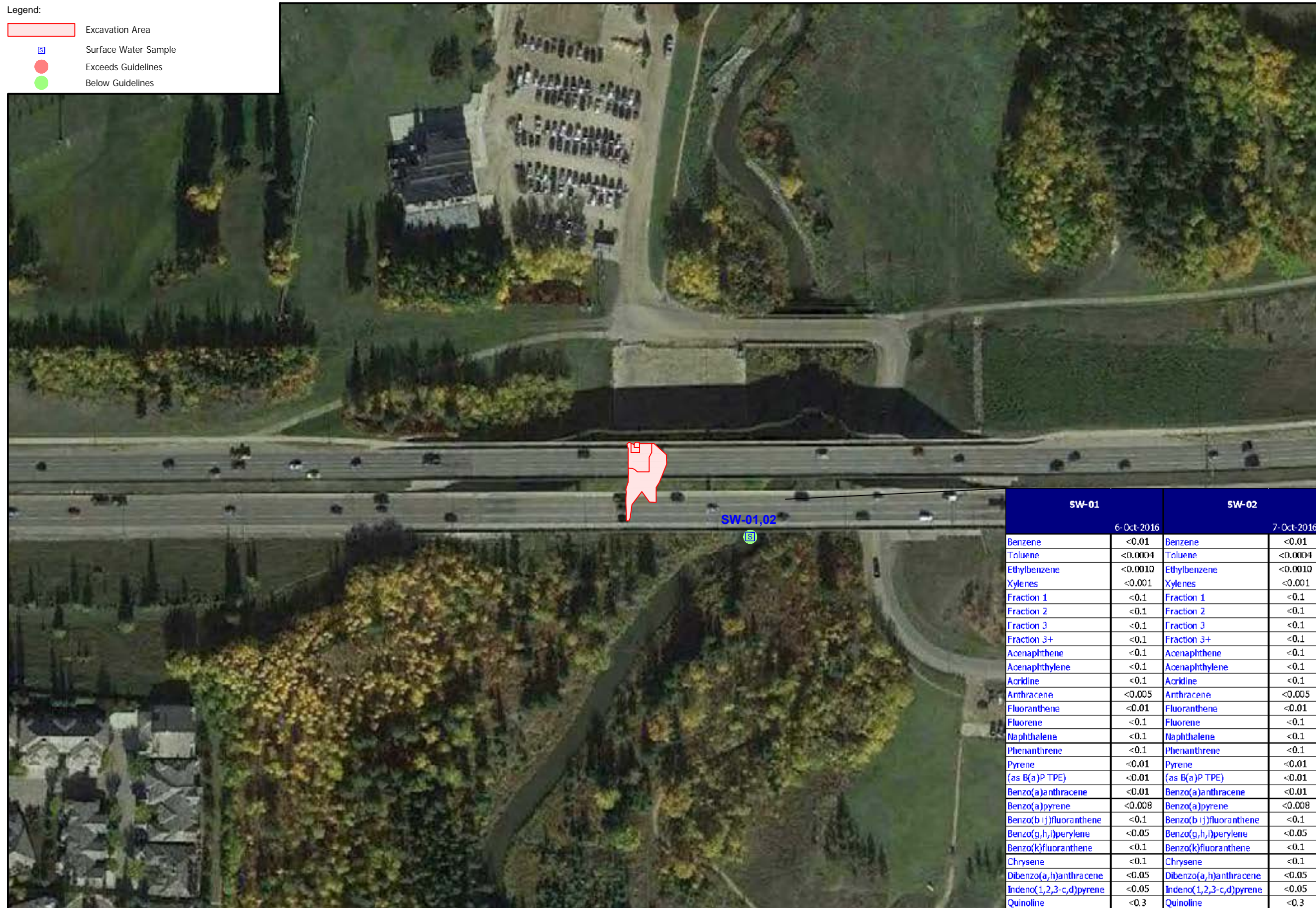

	SW-01	SW-02
	6-Oct-2016	7-Oct-2016
Benzene	<0.01	<0.01
Toluene	<0.0004	<0.0004
Ethylbenzene	<0.0010	<0.0010
Xylenes	<0.001	<0.001
Fraction 1	<0.1	<0.1
Fraction 2	<0.1	<0.1
Fraction 3	<0.1	<0.1
Fraction 3+	<0.1	<0.1
Acenaphthene	<0.1	<0.1
Acenaphthylene	<0.1	<0.1
Acridine	<0.1	<0.1
Anthracene	<0.005	<0.005
Fluoranthene	<0.01	<0.01
Fluorene	<0.1	<0.1
Naphthalene	<0.1	<0.1
Phenanthrene	<0.1	<0.1
Pyrene	<0.01	<0.01
(as B(a)P TPE)	<0.01	<0.01
Benzo(a)anthracene	<0.01	<0.01
Benzo(a)pyrene	<0.008	<0.008
Benzo(b,j)fluoranthene	<0.1	<0.1
Benzo(g,h,i)perylene	<0.05	<0.05
Benzo(k)fluoranthene	<0.1	<0.1
Chrysene	<0.1	<0.1
Dibenzo(a,h)anthracene	<0.05	<0.05
Indeno(1,2,3-c,d)pyrene	<0.05	<0.05
Quinoline	<0.3	<0.3



NICHOLS ENVIRONMENTAL (CANADA) LTD.

Environmental Quality Guidelines for Alberta Surface Waters

Protection of Aquatic Life	
Benzene	0.040
Toluene	0.0005
Ethylbenzene	0.090
Xylenes	0.030
Fraction 1	0.150
Fraction 2	0.110
Fraction 3	-
Fraction 3+	-
Acenaphthene	0.0058
Acenaphthylene	--
Acridine	0.0044
Anthracene	0.000012
Fluoranthene	0.00004
Fluorene	0.003
Naphthalene	0.001
Phenanthrene	0.0004
Pyrene	0.000025
(as B(a)P TPE)	--
Benzo(a)anthracene	0.000019
Benzo(a)pyrene	0.000015
Benzo(b,j)fluoranthene	--
Benzo(g,h,i)perylene	--
Benzo(k)fluoranthene	--
Chrysene	--
Dibenzo(a,h)anthracene	--
Indeno(1,2,3-c,d)pyrene	--
Quinoline	0.0034

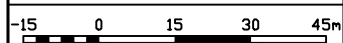

CLIENT
 The City of Edmonton

PROJECT
 Spill Response and Remediation Program
 Rainbow Valley Road Beneath
 Whitemud Drive
 Edmonton, Alberta

DRAWING TITLE
 Surface Water Sample Location,
 Petroleum Hydrocarbon, and
 Polycyclic Aromatic Hydrocarbon Data

BASE/SITE PLAN PROVIDED BY
 Nichols Environmental (Canada) Ltd.

REVISION DATE
 December 2016

SCALE: 1:1,500
 APPROVED: MAH/LL

PROJECT NO.
 16-442-CRV

DRAWING NO.
 Figure 5

J:\2016\16-442-CRV Drawings\16-442-CRV.dwg Original drawing in colour. Black and white copies may not interpret properly.

TABLES



Nichols Environmental (Canada) Ltd.

TABLE: 1
TITLE: CLASS II LANDFILL CHARACTERIZATION

PROJECT#: 16-442-CRV
 CLIENT: The City of Edmonton
 PROJECT: Spill Response and Remediation Program
 SITE: Rainbow Valley Road beneath Whitemud Drive
 LOCATION: Edmonton, Alberta

	SAMPLE ID	AENV*
	LF-01	
Sample Date	6-Oct-2016	
OVC	9.3	
pH	8.6	2 to 12.5
Chloride	71	---
Flash Point	>75	61
Paint Filter Test	Solid Waste	Solid Waste
Leachable BTEX		
Benzene	<0.01	0.5
Toluene	<0.01	0.5
Ethylbenzene	<0.01	0.5
Xylenes	<0.02	0.5
Hydrocarbons		
Benzene	<0.005	---
Toluene	<0.02	---
Ethylbenzene	<0.005	---
Xylenes	<0.03	---
Fraction 1	<10	---
Fraction 2	<50	---
Fraction 3	255	---
Fraction 4	194	---
Leachable Metals		
Antimony	<0.005	500
Arsenic	<0.002	5
Barium	0.92	100
Beryllium	<0.001	5
Boron	<0.2	500
Cadmium	0.004	1
Chromium	<0.005	5
Cobalt	0.012	100
Copper	<0.10	100
Iron	<0.1	1000
Lead	<0.050	5
Mercury	<0.001	0.2
Nickel	<0.050	5
Selenium	<0.002	1
Silver	<0.005	5
Thallium	<0.0005	5
Uranium	<0.005	2
Vanadium	<0.01	100
Zinc	0.74	500
Zirconium	<0.01	500

BOLD = Applicable Guideline Criteria
BOLD = Parameter Exceeds Recommended Guideline Criteria

*Alberta Environment - Alberta User Guide for Waste Managers, Table 2 (August 1996).
 (all concentrations in mg/kg = ppm, unless noted)

ND = Non-detect (<0.1 ppmv OVC)
 NM = Not Measured
 OVC = Organic Vapour Concentration (ppmv)
 --- = No Value Provided in Guidelines



TABLE: 2
TITLE: EXCAVATION SAMPLE LOCATIONS AND FIELD VAPOURS

PROJECT#: 16-442-CRV
 CLIENT: The City of Edmonton
 PROJECT: Spill Response and Remediation Program
 SITE: Rainbow Valley Road beneath Whitemud Drive
 LOCATION: Edmonton, Alberta

Sample ID	Date	Location				Removed From Excavation	OVC	Notes
		North/South (m)	East/West (m)	Wall/Base	Depth (m)			
Resp-01*	6-Oct-2016	0 North	27 West	Base	0.05	Yes	190.2	Initial Assessment Sample, Replaced by SA-23 and SA-35
Resp-02		3 North	25 West	Base		Yes	175.8	Initial Assessment Sample, Replaced by SA-25
SA-01*	7-Oct-2016	25 South	29 West	Base	0.05	Yes	4.4	Intermediate Sample, Replaced by SA-33
SA-02		20 South	29 West	Base		No	1.7	Closure Sample
SA-03		20 South	28 West	Base		No	0.8	Closure Sample
SA-04		15 South	29 West	Base		No	3.7	Closure Sample
SA-05		15 South	24 West	Base		No	4.4	Closure Sample
SA-06		18 South	18 West	Base		No	4.1	Closure Sample
SA-07		18 South	15 West	Base		No	0.7	Closure Sample
SA-08		15 South	19 West	Base		No	1.1	Closure Sample
SA-09		15 South	15 West	Base		No	1.4	Closure Sample
SA-10		10 South	28 West	Base		No	1.6	Closure Sample
SA-11		10 South	23 West	Base		No	3.1	Closure Sample
SA-12*		10 South	18 West	Base		No	3.4	Closure Sample
SA-13		10 South	14 West	Base		No	1.5	Closure Sample
SA-14		5 South	13 West	Base		No	2.3	Closure Sample
SA-15		5 South	18 West	Base		No	1.2	Closure Sample
SA-16		5 South	23 West	Base		No	2.2	Closure Sample
SA-17		5 South	28 West	Base		No	3.6	Closure Sample
SA-18*		7-Oct-2016	5 North	24 West		Base	1.80	No
SA-19	6 North		24 West	North Wall	No	1.9		Closure Sample
SA-20	5 North		26 West	West Wall	No	4.8		Closure Sample
SA-21	5 North	24 West	East Wall	1.00	No	2.4	Closure Sample	
SA-22*	4 North	24 West	South Wall		Yes	6.6	Intermediate Sample, Replaced by SA-36	
SA-23*	0 North	27 West	Base		Yes	5.5	Intermediate Sample, Replaced by SA-35	
SA-24	5 North	27 West	Base	0.05	No	2.9	Closure Sample	
SA-25	3 North	25 West	Base	0.50	No	4.0	Closure Sample	
SA-26	0 North	22 West	Base	0.30	No	4.3	Closure Sample	
SA-27*	0 North	17 West	Base	0.05	No	6.7	Closure Sample	
SA-28	0 North	12 West	Base		No	0.9	Closure Sample	
SA-29	5 North	17 West	Base		Yes	78.5	Intermediate Sample, Replaced by SA-31	
SA-30	5 North	22 West	Base	0.30	Yes	36.6	Intermediate Sample, Replaced by SA-32	
SA-31	5 North	17 West	Base	0.15	No	1.4	Closure Sample	
SA-32	5 North	22 West	Base		No	1.5	Closure Sample	
SA-33*	25 South	29 West	Base		0.15	No	1.5	Closure Sample
SA-34*	21-Oct-2016	30 South	29 West	Base	0.05	No	2.6	Closure Sample
SA-35*		0 North	27 West	Base	0.30	No	5.2	Closure Sample
SA-36*		3.7 North	24 West	South Wall	1.00	No	4.3	Closure Sample

* Sample Submitted for Laboratory Analyses
 Resp-01 = Initial Response Sample
 (All concentrations in parts per million by volume = ppmv, unless noted)
 ND = Non-detect (<0.1 ppmv OVC)
 NM = Not Measured
 OVC = Organic Vapour Concentration (ppmv)
 = Intermediate Sample Removed From The Excavation



Nichols Environmental (Canada) Ltd.

TABLE: 3

TITLE: SOIL ANALYSES - PETROLEUM HYDROCARBONS

PROJECT#: 16-442-CRV
 CLIENT: The City of Edmonton
 PROJECT: Spill Response and Remediation Program
 SITE: Rainbow Valley Road beneath Whitemud Drive
 LOCATION: Edmonton, Alberta

2016 Alberta Tier 1*	Fine Grained	Benzene	Toluene	Ethylbenzene	Xylenes	Fraction 1	Fraction 2	Fraction 3	Fraction 4
		Natural Area	0.046	0.52	0.073	0.99	210	150	1,300
	Agricultural	0.046	0.52	0.073	0.99	210	150	1,300	5,600
	Residential / Parkland	0.046	0.52	0.073	0.99	210	150	1,300	5,600
Surface Soil	Commercial	0.046	0.52	0.073	0.99	320	260	2,500	6,600
	Industrial	0.046	0.52	0.073	0.99	320	260	2,500	6,600

Surface Soil				Benzene	Toluene	Ethylbenzene	Xylenes	Fraction 1	Fraction 2	Fraction 3	Fraction 4
Land Use	Natural Area			0.046	0.52	0.073	0.99	210	150	1,300	5,600
Sample ID	Depth (m)	Date	OVC								
Resp-01	0.05	6-Oct-2016	190.2	0.05	1.46	2.11	14.2	329	6110	9160	585
SA-01	0.05	7-Oct-2016	4.4	<0.005	<0.02	<0.005	<0.03	<10	<50	311	<100
SA-12	0.05	7-Oct-2016	3.4	<0.005	<0.02	<0.005	<0.03	<10	<50	113	<100
SA-18	1.80	7-Oct-2016	3.5	<0.005	<0.02	<0.005	<0.03	<10	<50	66	<100
SA-22	1.00	7-Oct-2016	6.6	<0.005	<0.02	<0.005	<0.03	<10	74	643	815
SA-23	0.15	7-Oct-2016	5.5	<0.005	<0.02	<0.005	<0.03	<10	<50	55	<100
SA-27	0.05	7-Oct-2016	6.7	<0.005	<0.02	<0.005	<0.03	<10	<50	91	<100

- BOLD** = Applicable Guideline Criteria
- BOLD** = Parameter Exceeds Recommended Guideline Criteria
- BOLD** = Intermediate Sample Removed From The Excavation

*Alberta Tier 1 Soil and Groundwater Remediation Guidelines (Table 1). February 2016.

**Canadian Council of Ministers of the Environment (CCME) 1999 Canadian Environmental Quality Guidelines (as amended to Update 7.0)

(all concentrations in mg/kg = ppm, unless noted)

Grain Size MUST PSA D50 > 75 um 17.9% SA-12 @ 0.05 m (Fine Grained)

Fraction 1 = C₆ to C₁₀ (-BTEX) Fraction 3 = > C₁₆ to C₃₄
 Fraction 2 = > C₁₀ to C₁₆ Fraction 4 = C₃₅+

ND = Non-detect (<0.1 ppmv OVC)
 NM = Not Measured
 OVC = Organic Vapour Concentration (ppmv)
 ... = No Value Provided in Guidelines



TABLE: 4

TITLE: SOIL ANALYSES - POLYCYCLIC AROMATIC HYDROCARBONS

PROJECT#: 16-442-CRV
 CLIENT: The City of Edmonton
 PROJECT: Spill Response and Remediation Program
 SITE: Rainbow Valley Road beneath Whitemud Drive
 LOCATION: Edmonton, Alberta

Depth (m)	SAMPLE IDENTIFICATION											2016 Alberta Tier 1 *								
	Resp-01	SA-01	SA-12	SA-18	SA-22	SA-23	SA-27	SA-33	SA-34	SA-35	SA-36	Fine Grained								
Sample Date	6-Oct-2016						7-Oct-2016					21-Oct-2016				Land Use				
OVC	190.2	4.4	3.4	3.5	6.6	5.5	6.7	1.5	2.6	5.2	4.3	Natural Area	Agricultural	Residential / Parkland	Commercial	Industrial				
Acenaphthene	0.47	<0.05	<0.05	<0.05	<0.05	<0.05	<0.05	<0.05	<0.05	<0.05	<0.05	0.32	0.32	0.32	0.32	0.32				
Acenaphthylene	<0.05	<0.05	<0.05	<0.05	<0.05	<0.05	<0.05	<0.05	<0.05	<0.05	<0.05	-	--	---	----	-----				
Anthracene	<0.003	0.009	<0.003	<0.003	0.018	<0.003	<0.003	<0.003	<0.003	<0.003	<0.003	0.0046	0.0046	0.0046	0.0046	0.0046				
Fluoranthene	0.09	0.07	0.01	0.01	0.06	<0.01	<0.01	<0.01	<0.01	<0.01	<0.01	0.032	0.032	0.032	0.032	0.032				
Fluorene	1.59	<0.05	<0.05	<0.05	0.13	<0.05	<0.05	<0.05	<0.05	<0.05	<0.05	0.29	0.29	0.29	0.29	0.29				
Naphthalene	1.54	<0.010	<0.010	<0.010	0.036	0.019	<0.010	<0.010	<0.010	<0.010	<0.010	0.014	0.014	0.014	0.014	0.014				
Phenanthrene	1	0.03	0.01	0.01	0.44	0.02	<0.01	<0.01	<0.01	<0.01	<0.01	0.051	0.051	0.051	0.051	0.051				
Pyrene	0.35	0.07	<0.01	<0.01	0.12	<0.01	0.01	<0.01	<0.01	<0.01	<0.01	0.034	0.034	0.034	0.034	0.034				
Carcinogenic PAHs																				
IACR (Coarse)	0.028	0.017	<0.001	0.004	0.020	<0.001	<0.001	<0.001	<0.001	<0.001	<0.001	IACR < 1.0								
IACR (Fine)	0.055	0.032	<0.001	0.009	0.040	<0.001	0.001	<0.001	<0.001	<0.001	<0.001	IACR < 1.0								
Benzo(a)anthracene	0.03	0.03	<0.01	<0.01	0.03	<0.01	<0.01	<0.01	<0.01	<0.01	<0.01	0.070	0.070	0.070	0.070	0.070				
Benzo(a)pyrene	<0.05	<0.05	<0.05	<0.04	<0.05	<0.05	<0.05	<0.05	<0.05	<0.05	<0.05	0.60	0.60	0.70	0.70	0.70				
Benzo(b+j)fluoranthene	<0.05	<0.05	<0.05	<0.05	<0.05	<0.05	<0.05	<0.05	<0.05	<0.05	<0.05	6.2	6.2	---	----	-----				
Benzo(g,h,i)perylene	<0.05	<0.05	<0.05	<0.05	<0.05	<0.05	<0.05	<0.05	<0.05	<0.05	<0.05	-	--	---	----	-----				
Benzo(k)fluoranthene	<0.05	<0.05	<0.05	<0.05	<0.05	<0.05	<0.05	<0.05	<0.05	<0.05	<0.05	6.2	6.2	---	----	-----				
Chrysene	0.06	<0.05	<0.05	<0.05	0.05	<0.05	<0.05	<0.05	<0.05	<0.05	<0.05	6.2	6.2	---	----	-----				
Dibenzo(a,h)anthracene	<0.05	<0.05	<0.05	<0.05	<0.05	<0.05	<0.05	<0.05	<0.05	<0.05	<0.05	-	--	---	----	-----				
Indeno(1,2,3-c,d)pyrene	<0.05	<0.05	<0.05	<0.05	<0.05	<0.05	<0.05	<0.05	<0.05	<0.05	<0.05	-	--	---	----	-----				

BOLD = Applicable Guideline Criteria
BOLD = Parameter Exceeds Recommended Guideline Criteria
 = Intermediate Sample Removed From The Excavation

* Alberta Tier 1 Soil and Groundwater Remediation Guidelines (Table 1). February 2016.
 (all concentrations in mg/kg = ppm, unless noted)

Grain Size MUST PSA D50 > 75 um 17.9% SA-12 @ 0.05 m (Fine Grained)

IACR = Index of Additive Cancer Risk
 ND = Non-detect (<0.1 ppmv OVC)
 NM = Not Measured
 OVC = Organic Vapour Concentration (ppmv)
 --- = No Value Provided in Guidelines



Nichols Environmental (Canada) Ltd.

TABLE: 5
TITLE: SOIL ANALYSES - BACKFILL CHARACTERIZATION

PROJECT#: 16-442-CRV
 CLIENT: The City of Edmonton
 PROJECT: Spill Response and Remediation Program
 SITE: Rainbow Valley Road beneath Whitemud Drive
 LOCATION: Edmonton, Alberta

Depth (m)	SAMPLE ID	2016 Alberta Tier 1 *				
		Fine Grained				
Sample Date	21-Oct-2016	Land Use:		Natural Area		
OVC	1.2	Natural Area	Agricultural	Residential / Parkland	Commercial	Industrial
Petroleum Hydrocarbons						
Benzene	<0.005	0.046	0.046	0.046	0.046	0.046
Toluene	<0.02	0.52	0.52	0.52	0.52	0.52
Ethylbenzene	<0.005	0.073	0.073	0.073	0.073	0.073
Xylenes	<0.03	0.99	0.99	0.99	0.99	0.99
Fraction 1	<10	210	210	210	320	320
Fraction 2	<50	150	150	150	260	260
Fraction 3	<50	1,300	1,300	1,300	2,500	2,500
Fraction 4	<100	5,600	5,600	5,600	6,600	6,600
Salinity						
EC	0.82	2	2	2	4	4
SAR	0.3	8	8	8	12	12
pH	6.2	6 - 8.5				
Calcium	75.7	No Guidelines				
Chloride	12					
Magnesium	17.6					
Potassium	2					
Sodium	10					
Nitrate + Nitrite						
Sulphate	38.6					
Metals						
Antimony	0.3	20	20	20	40	40
Arsenic	8.3	17	17	17	26	26
Barium	188	750	750	500	2,000	2,000
Beryllium	0.7	5	5	5	8	8
Boron (SP)	0.13	3.3	3.3	3.3	5.0	5.0
Cadmium	0.23	3.8	1.4	10	22	22
Chromium (total)	18.9	64	64	64	87	87
Cobalt	9.3	20	20	20	300	300
Copper	17.5	63	63	63	91	91
Lead	9.4	70	70	140	260	600
Mercury (inorganic)	<0.05	12	6.6	6.6	24	50
Molybdenum	<1.0	4	4	4	40	40
Nickel	24.7	45	45	45	89	89
Selenium	0.7	1	1	1	2.9	2.9
Silver	0.1	20	20	20	40	40
Thallium	0.13	1	1	1	1	1
Tin	<1.0	5	5	5	300	300
Uranium	2.1	33	23	23	33	300
Vanadium	28.8	130	130	130	130	130
Zinc	72	200	200	200	360	360

BOLD = Applicable Guideline Criteria
BOLD = Parameter Exceeds Guideline or for Salinity (EC/SAR) is "Unsuitable"

*Alberta Tier 1 Soil and Groundwater Remediation Guidelines (Table 1 and 4). February 2016.
 (all concentrations in mg/kg = ppm, unless noted)

- EC = Electrical Conductivity (dS/m)
- ND = Non-detect (<0.1 ppmv OVC)
- NM = Not Measured
- OVC = Organic Vapour Concentration (ppmv)
- SAR = Sodium Adsorption Ratio
- SP = Saturated Paste (mg/L)



Nichols Environmental (Canada) Ltd.

TABLE: 6
TITLE: SURFACE WATER ANALYSES - PETROLEUM HYDROCARBONS

PROJECT#: 16-442-CRV
 CLIENT: The City of Edmonton
 PROJECT: Spill Response and Remediation Program
 SITE: Rainbow Valley Road beneath Whitemud Drive
 LOCATION: Edmonton, Alberta

2014 EQGSW*								
Land Use	Benzene	Toluene	Ethylbenzene	Xylenes	Fraction 1	Fraction 2	Fraction 3	Fraction 3+
Protection of Aquatic Life (PAL)	0.040	0.0005	0.090	0.030	0.150	0.110	--	--
Agricultural: Irrigation	---	---	---	---	---	---	---	---
Agricultural: Livestock	----	0.024	0.0024	----	----	----	----	----
Drinking Water**	0.005	0.024	0.0016	0.02	2.2	1.1	--	--

		Benzene	Toluene	Ethylbenzene	Xylenes	Fraction 1	Fraction 2	Fraction 3	Fraction 3+
Protection of Aquatic Life (PAL)		0.040	0.0005	0.090	0.030	0.150	0.110	--	--
Sample ID	Date								
SW-01	6-Oct-2016	<0.01	<0.0004	<0.0010	<0.001	<0.1	<0.1	<0.1	<0.1
SW-02	7-Oct-2016	<0.01	<0.0004	<0.0010	<0.001	<0.1	<0.1	<0.1	<0.1

BOLD = Applicable Guideline Criteria
BOLD = Parameter Exceeds Recommended Guideline Criteria

*Environmental Quality Guidelines for Alberta Surface Waters (EQGSW, July 2014)
 **Alberta Soil and Groundwater Remediation Guidelines (Tables B-1 to B-4). February 2016.
 (all concentrations in mg/L = ppm, unless noted)

Fraction 1 = C₆ to C₁₀ (-BTEX) Fraction 3 = > C₁₆ to C₃₄
 Fraction 2 = > C₁₀ to C₁₆ Fraction 3+ = C₃₅+
 NGR = No Guideline Required
 --- = No Value Provided in Guidelines



Nichols Environmental (Canada) Ltd.

TABLE: 7

TITLE: SURFACE WATER ANALYSES - POLYCYCLIC AROMATIC HYDROCARBONS

PROJECT#: 16-442-CRV
 CLIENT: The City of Edmonton
 PROJECT: Spill Response and Remediation Program
 SITE: Rainbow Valley Road beneath Whitemud Drive
 LOCATION: Edmonton, Alberta

Location	SAMPLE IDENTIFICATION		2014 EQGSW*		
	SW-01	SW-02	Land Use:	Protection of Aquatic Life (PAL)	
Sample Date	6-Oct-2016	7-Oct-2016	PAL	Agricultural: Irrigation	Agricultural: Livestock
Acenaphthene	<0.1	<0.1	0.0058	---	----
Acenaphthylene	<0.1	<0.1	--	---	----
Acridine	<0.1	<0.1	0.0044	---	----
Anthracene	<0.005	<0.005	0.000012	---	----
Fluoranthene	<0.01	<0.01	0.00004	---	----
Fluorene	<0.1	<0.1	0.003	---	----
Naphthalene	<0.1	<0.1	0.001	---	----
Phenanthrene	<0.1	<0.1	0.0004	---	----
Pyrene	<0.01	<0.01	0.000025	---	----
Carcinogenic PAHs (as B(a)P TPE)	<0.01	<0.01	--	---	----
Benzo(a)anthracene	<0.01	<0.01	0.000018	---	----
Benzo(a)pyrene	<0.008	<0.008	0.000015	---	----
Benzo(b+j)fluoranthene	<0.1	<0.1	--	---	----
Benzo(g,h,i)perylene	<0.05	<0.05	--	---	----
Benzo(k)fluoranthene	<0.1	<0.1	--	---	----
Chrysene	<0.1	<0.1	--	---	----
Dibenzo(a,h)anthracene	<0.05	<0.05	--	---	----
Indeno(1,2,3-c,d)pyrene	<0.05	<0.05	--	---	----
Quinoline	<0.3	<0.3	0.0034	---	----

BOLD = Applicable Guideline Criteria
BOLD = Parameter Exceeds Recommended Guideline Criteria

*Environmental Quality Guidelines for Alberta Surface Waters (EQGSW, July 2014)
 (all concentrations in mg/L = ppm, unless noted)

--- = No Value Provided in Guidelines

APPENDIX A

Record of Site Condition



1 REPORT AND FORM INFORMATION

Title of report	Spill Response and Remediation Program		
Report date (dd-mon-yyyy)	12-Dec-2016	Record of Site Condition (RSC) ID No. ^ψ	

2 SITE IDENTIFICATION AND PHYSICAL LOCATION

2.1 Site name	Rainbow Valley Road Beneath Whitemud Drive							
2.2 Address of site	Municipality							Alberta
	Edmonton							
2.3 Legal land description of site (if multiple, list all.)								
Plan, Block, Lot (PBL)			Alberta Township System (ATS)					
Plan	Block	Lot	LSD	Quarter	Section	Township	Range	Meridian
			14	NW	12	052	25	4

3 STAKEHOLDERS

3.1 Operator

Company	The City of Edmonton	Contact person	Aaron Lewicki
Mailing address	11004 - 190 th Street NW Edmonton, Alberta T5S 0G9	Position held	Environmental Engineer
		Business phone No.	780-944-5341
		Business fax No.	780-944-7653
		Business e-mail	aaron.lewicki@edmonton.ca

3.2 Consultant Not applicable

Company	Nichols Environmental (Canada) Ltd.	Contact person	Barry Rakewich
Mailing address	17331 - 107 th Avenue NW Edmonton, Alberta T5S 1E5	Position held	GM - Environmental
		Business phone No.	780-484-3377
		Business fax No.	780-484-5093
		Business e-mail	rakewich@nicholsenvironmental.com

3.3 Landowner(s)

Land type	<input checked="" type="checkbox"/> Private <input type="checkbox"/> Special Areas <input type="checkbox"/> Parks and protected area <input type="checkbox"/> Public (if not private, provide Disposition No.: _____)			
Landowner(s)	<input checked="" type="checkbox"/> Same as operator <input type="checkbox"/> Other			

^ψ: Do not fill in. Reserved for internal administrative purposes only.

Record of Site Condition



3.4 Occupant(s)			
Are there occupants at the site?	<input type="checkbox"/> Yes	<input checked="" type="checkbox"/> No	<input type="checkbox"/> To be determined (TBD)
Occupant(s)	<input type="checkbox"/> Same as operator	<input type="checkbox"/> Same as landowner	<input type="checkbox"/> Other
What is the type of occupancy?	<input type="checkbox"/> Apartment building	<input type="checkbox"/> Town house	<input type="checkbox"/> Single detached house
	<input type="checkbox"/> Agricultural	<input type="checkbox"/> Industrial	<input type="checkbox"/> Commercial
	<input type="checkbox"/> Other (<i>specify</i>) _____		

4 OPERATING STATUS				
<input type="checkbox"/> Operating	<input type="checkbox"/> Suspended	<input type="checkbox"/> Abandoned	<input type="checkbox"/> Decommissioning in progress	<input type="checkbox"/> Closed
<input type="checkbox"/> Reclaimed (<i>provide Reclamation Certificate No.(s):</i> _____)			<input checked="" type="checkbox"/> Not applicable	

5 TYPE OF ACTIVITY AND SITE

5.1 Petroleum Storage Tank Site	<input type="checkbox"/> Yes
--	------------------------------

5.1.1 ESRD file No.(s)		PTMAA site No.	
-------------------------------	--	-----------------------	--

5.1.2 Types of activity				
<input type="checkbox"/> Retail gas station	<input type="checkbox"/> Aviation fuelling station	<input type="checkbox"/> Bulk fuel	<input type="checkbox"/> Other (<i>specify</i>): _____	

5.2 Upstream Oil and Gas Facility	<input type="checkbox"/> Yes
--	------------------------------

5.2.1 ESRD file No.(s)		AER approval No.(s)	
-------------------------------	--	----------------------------	--

5.2.2 AER authorization type	<input type="checkbox"/> Approval	<input type="checkbox"/> License	<input type="checkbox"/> Permit	<input type="checkbox"/> Order	<input type="checkbox"/> Other (<i>specify</i>) _____
-------------------------------------	-----------------------------------	----------------------------------	---------------------------------	--------------------------------	---

5.2.3 Types of activity				
<input type="checkbox"/> Wellsite and associated facility	<input type="checkbox"/> Satellite	<input type="checkbox"/> Battery	<input type="checkbox"/> Pipeline	
<input type="checkbox"/> Compressor and pumping station	<input type="checkbox"/> Other (<i>specify</i>): _____			

5.3 Approved Facility Under Environmental Protection and Enhancement Act (EPEA)	<input type="checkbox"/> Yes
--	------------------------------

5.3.1 ESRD approval No.(s)		AER approval No.(s)	
-----------------------------------	--	----------------------------	--

5.3.2 Types of approved activity					
<input type="checkbox"/> Chemical manufacturing plant	<input type="checkbox"/> Enhanced recovery in-situ oil sands or heavy oil processing plant	<input type="checkbox"/> Fertilizer manufacturing plant	<input type="checkbox"/> Landfill		
<input type="checkbox"/> Metal manufacturing plant	<input type="checkbox"/> Oil refinery	<input type="checkbox"/> Oilsands processing plant	<input type="checkbox"/> Oil production site		
<input type="checkbox"/> Pesticide manufacturing plant	<input type="checkbox"/> Petrochemical manufacturing plant	<input type="checkbox"/> Pipeline	<input type="checkbox"/> Power plant		
<input type="checkbox"/> Pulp and paper processing plant	<input type="checkbox"/> Sour gas processing plant	<input type="checkbox"/> Sulphur manufacturing or processing plant	<input type="checkbox"/> Waste management facility		
<input type="checkbox"/> Wood treatment plant	<input type="checkbox"/> Other (<i>specify</i>): _____				

Record of Site Condition



5.4 Facility Under EPEA Code of Practice				<input type="checkbox"/> Yes	
5.4.1 ESRD registration No.(s)				AER registration No.(s)	
5.4.2 Type of Code of Practice					
<input type="checkbox"/>	Asphalt paving plant	<input type="checkbox"/>	Compressor and pumping station	<input type="checkbox"/>	Concrete producing plant
<input type="checkbox"/>	Pesticides	<input type="checkbox"/>	Pipeline	<input type="checkbox"/>	Land treatment of soils containing hydrocarbons
<input type="checkbox"/>	Small incinerator	<input type="checkbox"/>	Sweet gas processing plant	<input type="checkbox"/>	Other (<i>specify</i>): _____
5.5 Other Activity				<input checked="" type="checkbox"/> Yes	
5.5.1 ESRD file No.(s)		Other site ID No.(s)		Authorized by	
5.5.2 Types of activity					
<input type="checkbox"/>	Dry cleaning operation	<input type="checkbox"/>	Highway maintenance yard	<input type="checkbox"/>	Transportation
<input checked="" type="checkbox"/>	Other (<i>specify</i>): <u>City-owned park</u>				

6 SITE CHARACTERIZATION

6.1 What Environmental Site Assessments (ESA) Have Been Conducted and Completed to Date?

Phase I ESA
 Phase II ESA (*check all that apply.*)
 Initial intrusive sampling
 delineation completed
 post-remediation monitoring
 final confirmatory sampling

6.2 Contaminants of Potential Concern (COPC)

6.2.1 Does the site have any of the conditions that require the mandatory use of Alberta Tier 2 Soil and Groundwater Remediation Guidelines (ESRD, 2007 and updates)? (*check all that apply in Section 6.2.1.1.*)

Yes
 No (*→ proceed to Section 6.2.2.*)

6.2.1.1 Identify any conditions that require the approaches of the Alberta Tier 2 guidelines. (see Alberta Tier 1 Soil and Groundwater Remediation Guidelines (ESRD, 2007 and updates), for details.)

<input type="checkbox"/>	Contamination within 30 cm of building foundation	<input type="checkbox"/>	Unusual building feature (<i>eg. earthen floor</i>)	<input type="checkbox"/>	Contamination within 10 m distance of surface water body
<input type="checkbox"/>	Fractured bedrock	<input type="checkbox"/>	Potentially high hydraulic conductivity ($> 10^{-5}$ m/sec.)	<input type="checkbox"/>	Other (<i>see Alberta Tier 1 guidelines and specify</i>): _____

6.2.1.2 Did the Alberta Tier 2 approach lead to a soil or groundwater guideline that was lower than the corresponding Tier 1 guideline for the same contaminant(s)?

Yes
 TBD
 No (*→ proceed to Section 6.2.2.*)

6.2.1.3 If you answered 'yes' or 'TBD' to Section 6.2.1.2, identify the group of contaminants for each COPC with a mandatory Tier 2 guideline that is lower than the corresponding Tier 1 guideline (check all that apply, see Alberta Tier 1 guidelines, Tables 1-4 for detailed listing).

<input type="checkbox"/>	General and inorganic parameters	<input type="checkbox"/>	Metals
<input type="checkbox"/>	Hydrocarbons	<input type="checkbox"/>	Halogenated aliphatics
<input type="checkbox"/>	Chlorinated aromatics	<input type="checkbox"/>	Pesticides
<input type="checkbox"/>	Other organics	<input type="checkbox"/>	Radionuclides
<input type="checkbox"/>	Salt	<input type="checkbox"/>	Other (<i>specify</i>): _____

Record of Site Condition



6.2.1.4 Did any past or current ESA relevant to this investigation identify an exceedance of the mandatory Tier 2 guidelines referred to in Section 6.2.1.3 (e.g. Tier 2 guidelines that are lower than the corresponding Tier 1 guidelines)?		<input type="checkbox"/> Yes <input type="checkbox"/> No <input type="checkbox"/> TBD	
6.2.1.5 If you answered 'yes' in Section 6.2.1.4, have all relevant COPC been remediated to meet the mandatory Tier 2 guidelines?		<input type="checkbox"/> Yes <input type="checkbox"/> No	
6.2.2. Did any past or current ESA relevant to this investigation identify a drilling waste disposal area?			
<input type="checkbox"/> Yes <input checked="" type="checkbox"/> No (→ proceed to Section 6.2.3.)			
6.2.2.1 If a drilling waste disposal area was identified, did any past or current ESA identify non-compliance with the compliance options outlined in <i>Assessing Drilling Waste Disposal Areas: Compliance Options for Reclamation Certification</i> (AER, 2014), as amended?			
<input type="checkbox"/> Yes <input type="checkbox"/> No			
6.2.2.2 If you answered 'yes' in Section 6.2.2.1, have all COPC been remediated to meet the compliance options outlined in <i>Assessing Drilling Waste Disposal Areas: Compliance Options for Reclamation Certification</i> (AER, 2014), as amended?			
<input type="checkbox"/> Yes <input type="checkbox"/> No			
6.2.2.3 For any COPC that did not meet the compliance options in <i>Assessing Drilling Waste Disposal Areas</i>, identify the group of contaminants (check of all that apply, see the Alberta Tier 1 guidelines, Tables 1-4 for detailed listing).			
<input type="checkbox"/>	General and inorganic parameters	<input type="checkbox"/>	Metals
<input type="checkbox"/>	Hydrocarbons	<input type="checkbox"/>	Halogenated aliphatics
<input type="checkbox"/>	Chlorinated aromatics	<input type="checkbox"/>	Pesticides
<input type="checkbox"/>	Other organics	<input type="checkbox"/>	Radionuclides
<input type="checkbox"/>	Salt	<input type="checkbox"/>	Other (specify): _____
6.2.3 For all areas and COPCs not assessed under Sections 6.2.1 or 6.2.2, did any ESA relevant to this investigation identify an exceedance over the Alberta Tier 1 guidelines?			
<input checked="" type="checkbox"/> Yes <input type="checkbox"/> No (→ proceed to Section 6.3.)			
6.2.3.1 If you answered 'yes' in Section 6.2.3, have all COPC been remediated to meet the Alberta Tier 1 guidelines?			
<input checked="" type="checkbox"/> Yes <input type="checkbox"/> No <input type="checkbox"/> TBD			
6.2.3.2 For any COPC that exceeded Alberta Tier 1 guidelines in Section 6.2.3.1, identify the group of contaminants. (check all that apply, see the Alberta Tier 1 guidelines, Tables 1-4 for detailed listing.)			
<input type="checkbox"/>	General and inorganic parameters	<input type="checkbox"/>	Metals
<input checked="" type="checkbox"/>	Hydrocarbons	<input type="checkbox"/>	Halogenated aliphatics
<input type="checkbox"/>	Chlorinated aromatics	<input type="checkbox"/>	Pesticides
<input type="checkbox"/>	Other organics	<input type="checkbox"/>	Radionuclides
<input type="checkbox"/>	Salt	<input type="checkbox"/>	Other (specify): _____

Record of Site Condition



6.3 Status of Investigation

6.3.1 Identify soil and groundwater guidelines used to assess the COPCs that are the subject of this investigation (check all that apply).

- Alberta Tier 1 Soil and Groundwater Remediation Guidelines – 2007 and updates,
 - Coarse grained
 - Fine grained
- Alberta Tier 2 Soil and Groundwater Remediation Guidelines – 2007 and updates,
 - Pathway exclusion
 - Guideline adjustment
 - Site specific remediation objectives
- Assessing Drilling Waste Disposal Areas: Compliance Options for Reclamation Certification (AER, 2014), as amended
- Other (specify): _____

6.3.2 What land use classification(s) is used?

- Natural
- Agricultural
- Residential
- Commercial
- Industrial
- Other (specify: _____)

6.3.3 What is the outcome of the investigation? (check one only.)

- For all COPCs on-site and off-site, no exceedance has been found above any applicable soil and groundwater guidelines in any prior and current assessments.
- All contamination on-site and off-site has been completely remediated and meets the applicable soil and groundwater guidelines.
- One or more COPC still exceeds the applicable soil or groundwater guidelines.

6.3.4 How many contaminated areas are there currently at the site?

- _____ None TBD

6.3.5 Are all contaminated areas and potential contaminated areas assessed during this investigation?

- Yes No

6.3.6 For all areas of potential environmental concern, list the dates when the contamination was discovered (specify dd-mon-yyyy): **October 6, 2016;** _____

6.3.7 For all areas that have been identified in Section 6.3.4, have all substance releases been reported to ESRD?

- Yes No Not applicable

6.3.8 If the answer to Section 6.3.7 is 'yes', list all Incident No.(s) (attach separate sheet if necessary):

- 316940; _____ Not assigned

6.3.9 What is the approximate, cumulative amount of land area remaining exceeding applicable remediation guidelines? _____ (m²) None TBD

6.3.10 Is there non-aqueous phase liquid (NAPL) product remaining on site? Yes No TBD

6.3.11 Is there non-aqueous phase liquid (NAPL) product remaining off site? Yes No TBD

6.3.12 What is the remediation status of the contaminated areas at site?

- | | |
|---|--|
| <input type="checkbox"/> No remediation required | <input type="checkbox"/> Site has exceedance but no remediation plan |
| <input type="checkbox"/> Remediation plan developed | <input type="checkbox"/> Active remediation |
| <input checked="" type="checkbox"/> Remediation completed | <input type="checkbox"/> Post remediation assessment completed |
| <input type="checkbox"/> Ongoing risk management plan – on-site | <input type="checkbox"/> Ongoing risk management plan – off-site |
| <input type="checkbox"/> Remediation Certificate issued for some area(s) (provide Remediation Certificate No.(s): _____) | |
| <input type="checkbox"/> Remediation Certificate cancelled for some area(s) (provide Remediation Certificate No.(s): _____) | |

Direction for Completing the Remainder of the Form

Attach the analytical summary tables of the COPCs that are the subject of this investigation and still present at this site. A detailed listing of COPCs can be found with Tables 1-4 in *Alberta Tier 1 Soil and Groundwater Remediation Guidelines* (ESRD, 2007 and updates), as amended. Refer to the *RSC User's Guide* for detailed information on format and other requirements regarding the summary table.

For the remainder of the form, follow the directions below:

- If the COPCs on-site and off-site have never exceeded any applicable soil and groundwater guidelines in any prior and current assessments, → proceed to Section 8, or
- If the COPCs on-site and off-site have been completely remediated and meet the applicable soil and groundwater guidelines, → proceed to Section 8, or
- For all other circumstances, continue with Section 6.4.

6.4 Key Transport Factors for Existing COPCs

6.4.1 What is the horizontal distance to the nearest water well from the edge of the nearest contaminated area?

0-50 m 50-100 m 100-300 m 300-1000 m > 1000 m

6.4.2 What is the horizontal distance to the nearest surface water body from the edge of the contaminated area?

≤10 m 10-50 m 50-100 m 100-300 m 300-1000 m > 1000 m

6.4.3 Does delineation achieve closure above the groundwater water table that is nearest to the ground surface?

Yes (→ go to Section 6.5.) No TBD

6.4.4 Is the groundwater that is nearest the ground surface a domestic use aquifer (DUA) as defined in Alberta Tier 2 guidelines?

Yes No TBD Not required (NR)

6.4.5 Is there a hydraulic barrier, as defined in Alberta Tier 2 guidelines, between the base of the contaminated area and the DUA?

Yes No TBD NR

6.4.6 If you answered 'yes' to Section 6.4.5, provide the measured largest value of the hydraulic conductivity (as value $\times 10^{-7}$ m/sec.) for the 5.0 m vertical layer from the bottom of the contaminated zone.

_____ ($\times 10^{-7}$ m/sec.) TBD NR

6.5 On-site Characterization

6.5.1 What is the dominant soil texture that governs substance transport at the site?

Coarse grained Fine grained TBD Not applicable (*must identify reason in Section 6.2.1.1.*)

6.5.2 What are the shallowest and deepest measured depths (meters below ground surface) of the water table at site?

Shallowest: _____ (m) Deepest: _____ (m) TBD NR (*specify max. depth assessed: _____ (m)*)

6.5.3 What is the dominant horizontal direction of groundwater flow for the near surface water table?

(N, NW, etc.: _____) TBD NR

6.5.4 What is the existing land use classification?

Natural Agricultural Residential Commercial Industrial Other (*specify*) _____

6.5.5 What is the end land use classification?

Natural Agricultural Residential Commercial Industrial Other (*specify*) _____

Record of Site Condition



6.5.6 Identify exposure pathways for which the applicable guidelines are exceeded on-site <i>(check all that apply)</i> .			
<input type="checkbox"/>	Vapour inhalation	<input type="checkbox"/>	Soil ingestion
<input type="checkbox"/>	Ingestion of potable water	<input type="checkbox"/>	Soil dermal (skin) contact
<input type="checkbox"/>	Fresh water aquatic life	<input type="checkbox"/>	Soil contact for plants and invertebrates
<input type="checkbox"/>	TBD	<input type="checkbox"/>	Other <i>(specify)</i> : _____

6.6 Off-site Characterization

6.6.1 Are there COPCs off-site exceeding applicable soil or groundwater guidelines?
 No (**→** *if on-site contamination was reported, proceed to Section 7, otherwise, proceed to Section 8.*)
 Yes TBD

6.6.2 What is the current land use classification for any off-site area(s) identified in Section 6.6.1?
 Natural Agricultural Residential Commercial Industrial Other *(specify)* _____

6.6.3 What is the end land use classification for any off-site area(s) identified in Section 6.6.1?
 Natural Agricultural Residential Commercial Industrial Other *(specify)* _____

6.6.4 Is there any substance concentration under a road allowance exceeding the applicable soil or groundwater guidelines?
 Yes No (**→** *proceed to Section 6.6.6.*) TBD

6.6.5 What is the most sensitive land use classification adjacent to the road allowance?
 Natural Agricultural Residential Commercial Industrial Other *(specify)* _____

6.6.6 Identify exposure pathways for which the applicable guidelines are exceeded off-site <i>(check all that apply)</i> .			
<input type="checkbox"/>	Vapour inhalation	<input type="checkbox"/>	Soil ingestion
<input type="checkbox"/>	Ingestion of potable water	<input type="checkbox"/>	Soil dermal (skin) contact
<input type="checkbox"/>	Fresh water aquatic life	<input type="checkbox"/>	Soil contact for plants and invertebrates
<input type="checkbox"/>	TBD	<input type="checkbox"/>	Other <i>(specify)</i> : _____

Record of Site Condition



7 RISK MANAGEMENT PLAN (RMP)

7.1 What is the Plan for Contaminated Areas Still Remaining on and off the Site? (check one only.)

- Complete remediation (→ proceed to Section 8).
- Partial remediation with risk management for some residual contamination.
- Risk management for all remaining contamination.

7.2 Key Progress of RMP

7.2.1 If the site needs an on-going RMP, answer all the following questions that apply to the RMP.

<input type="checkbox"/> Yes	<input type="checkbox"/> No	Are contaminated areas completely delineated horizontally and vertically in soil?
<input type="checkbox"/> Yes	<input type="checkbox"/> No	Are contaminated areas completely delineated horizontally and vertically in groundwater?
<input type="checkbox"/> Yes	<input type="checkbox"/> No	Is source identified and completely delineated?
<input type="checkbox"/> Yes	<input type="checkbox"/> No	Is source migrating or has migrated off-site?
<input type="checkbox"/> Yes	<input type="checkbox"/> No	Is source left as is?
<input type="checkbox"/> Yes	<input type="checkbox"/> No	Is source partially removed and residual source being managed?
<input type="checkbox"/> Yes	<input type="checkbox"/> No	Is source controlled with physical or administrative methods?
<input type="checkbox"/> Yes	<input type="checkbox"/> No	Are all pathways of concern identified?
<input type="checkbox"/> Yes	<input type="checkbox"/> No	Have all relevant receptors been identified and protected?
<input type="checkbox"/> Yes	<input type="checkbox"/> No	Is there a monitoring program in place to verify RMP success?
<input type="checkbox"/> Yes	<input type="checkbox"/> No	Are there third parties related to this RMP? (if the answer is 'no', skip the next question.)
<input type="checkbox"/> Yes	<input type="checkbox"/> No	If there are third parties, have all of them accepted the RMP?
<input type="checkbox"/> Yes	<input type="checkbox"/> No	Is there a commitment from person(s) responsible to implement and monitor the RMP until final remediation guidelines are achieved?
<input type="checkbox"/> Yes	<input type="checkbox"/> No	Is there a contingency plan in place should the RMP fail?
<input type="checkbox"/> Yes	<input type="checkbox"/> No	Is the RMP implemented for the site?

Public Disclosure and Privacy Notification

The *Record of Site Condition* form is a public record that is disclosed in accordance with section 35 of the *Environmental Protection and Enhancement Act*, *Disclosure of Information Regulation*, and *Ministerial Order 23/2004*. Reasonable efforts have been made to minimize collection of personal information where possible. Personal information on the form is collected under the authority of section 12(c) and other provisions of the *Environmental Protection and Enhancement Act* and is in compliance with section 33(a) and 33(c) of the *Freedom of Information and Protection of Privacy Act* (FOIP). Personal information collected on this form will be used by Alberta Environment and Sustainable Resource Development (ESRD) or the Alberta Energy Regulator (AER), as the case may be, for the purposes of administering its programs.

Accuracy of Information

The information in this document has been submitted by persons other than ESRD or the AER. The Department, the Government of Alberta, and the AER cannot and do not warrant that the information in this document is current, accurate, complete, or free of errors. Persons accessing the information provided should not rely on it, and any reliance on the information provided is taken at the sole risk of the user. Users of this information are advised to conduct their own due diligence to satisfy themselves of the environmental condition of the property of interest.

Record of Site Condition



8 DECLARATION

This *Record of Site Condition* form was prepared for the purpose of reporting on the state of environmental site conditions and, where applicable, for the purpose of remediation or reclamation, for:
Rainbow Valley Road Beneath Whitemud Drive (site name) (the "Site").

I, as the licensed operator or authorized representative, have reviewed all information that was used in preparation of this form and I am satisfied that it was prepared in a manner consistent with the Applicable Standard[⌚] together with any relevant additional guidance that is available from Alberta Environment and Sustainable Resource Development as of this date for conducting environmental site assessments.

Having conducted reasonable inquiries to obtain all relevant information, to my knowledge, the statements made in this form are true as of this date. I have disclosed all pertinent information of which I am aware concerning the historical and current environmental condition of the Site to the Director.

Any use which a third party, other than the Crown in right of Alberta or the AER, makes of this form, or any reliance on or decisions to be made based on it, are the responsibility of such third parties. The undersigned accepts no responsibility for damages, if any, suffered by any third party, other than the Crown in right of Alberta and the AER, as a result of decisions made or actions based on this form. Any exclusions or disclaimers to the contrary contained in any attachment to this form are of no force or effect as against the Crown in right of Alberta and the AER.

Footnote [⌚]:

"Applicable Standard" means

- a) for the purposes of upstream oil and gas sites,
 - i) *2010 Reclamation Criteria for Wellsites and Associated Facilities Application Guidelines* (ESRD 2011),
 - ii) *CSA Standard Z769, Phase II Environmental Site Assessment*, as amended, for any Phase II site assessment information used in preparation of this form on all upstream oil and gas sites not included in a) i);
- b) for the purposes of all other sites, *CSA Standard Z768, Phase I Environmental Site Assessment*, as amended, for any Phase I site assessment information and with *CSA Standard Z769, Phase II Environmental Site Assessment*, as amended, for any Phase II site assessment information used in preparation of this form.

By signing below, I as the licensed operator or authorized representative, confirm the information provided herein is correct and complete, to the best of my knowledge and belief.

	Barry Rakewich, P.Ag., EP	General Manager - Enviro, Nichols Environmental (Canada) Ltd.		12-Dec-2016
Name of operator	Name of authorized representative	Title of authorized representative (e.g. officer, director)	Signature	Date (dd-mon-yyyy)

APPENDIX B



Photograph 1: Diesel staining, resulting from the MVA, beneath the drainage culvert on Whitemud Drive (October 6, 2016).



Photograph 2: Whitemud Creek traverses north/south approximately 15 m south and east of the Site. SW-01 and SW-02 were collected at the closest point to the Site (October 6, 2016).



Photograph 3: Excavation of impacted soils from the Site (October 7, 2016).



Photograph 4: Impacted soils were contained in a poly-lined cell onsite for future disposal once landfill approval was granted (October 7, 2016).



Photograph 5: Rig mats were installed from the gravel-surfaced parking lot to the Site, in order to provide access for loading of haul trucks and removal of the impacted soil (October 12, 2016).



Photograph 6: The impacted soils were removed using tandem gravel trucks, and were hauled to the MCL Waste Systems Class II landfill near Leduc, Alberta (October 13, 2016).



Photograph 7: A seepage pit was re-constructed with a non-woven geotextile liner beneath the drainage culvert on the Whitemud Drive overpass (October 21, 2016).



Photograph 8: The seepage pit was filled with rip rap (October 21, 2016).



Photograph 9: The Site was backfilled with topsoil, re-contoured and track packed (October 21, 2016).



Photograph 10: The Site was re-seeded with a custom, native reclamation seed mix and then covered with erosion control blankets (October 25, 2016).

APPENDIX C

Daily Detail

From 10/1/2016 to 11/17/2016

TICKET NO	Date/Time Out	Gross	Net	Tare	DAY LOAD#	Unattended
967493	10-13-2016 11:24	20320	9690	10630	79	No
967496	10-13-2016 11:30	22140	10950	11190	82	No
967502	10-13-2016 11:39	20370	10260	10110	88	No
967511	10-13-2016 11:47	19610	8960	10650	97	No
967556	10-13-2016 12:57	21300	10730	10570	142	No
967566	10-13-2016 13:09	24310	13710	10600	152	No
967567	10-13-2016 13:10	22480	11290	11190	153	No
967570	10-13-2016 13:18	20930	10830	10100	156	No
967578	10-13-2016 13:27	22930	12290	10640	164	No
967642	10-13-2016 15:09	21350	12090	9260	228	No
967643	10-13-2016 15:10	22890	12310	10580	229	No
967558	10-13-2016 12:58	19190	9920	9270	144	No
968948	10-21-2016 13:24	16350	5690	10660	136	No
968949	10-21-2016 13:27	16810	6500	10310	137	No
969000	10-21-2016 14:38	18560	7040	11520	188	No
		309540	152260	157280	15	

Filter = (Ticket Detail.CUSTOMER ID = '1-3195')

Void tickets have been excluded from report

Displaying ticket records

Includes all (Invoiced and Uninvoiced)

APPENDIX D



FIELD INVESTIGATION METHODOLOGY - SOIL

All soil types were logged using the Modified Unified Soil Classification system.

Soil Sampling Procedure: Solid Stem Augers

Soil samples collected from boreholes are typically collected at 0.75 m intervals with any variation in sample collection depth noted on the borehole logs. The standard sampling procedure is as follows:

1. Samples collected from the auger were trimmed to remove the outer 5 to 10 mm to minimize cross contamination. A clean pair of latex gloves and putty knife were used for the procedure;
2. One half of the sample was transferred to a large plastic freezer bag and sealed for subsequent vapour measurement and/or laboratory analysis (inorganic);
3. The duplicate portion of the sample for laboratory analyses (organic), was transferred to 120-mL ESS glass jars, which were filled to capacity with soil and fitted with screw down, Teflon™-lined lids; and
4. Laboratory samples were stored in insulated coolers at approximately 4°C with the appropriate chain of custody information and transported to the analytical laboratory for chemical analyses.

Soil Sampling Procedure: Hollow Stem Augers

Soil samples were collected at various depth intervals, as depicted on the borehole logs. The sampling procedure is as follows:

1. The core sample collected from the A-Casing split spoon sampler was placed on a clean tray on the tailgate of the truck;
2. Samples collected from the A-Casing were trimmed to remove the outer 5 to 10 mm to minimize cross contamination. A clean pair of latex gloves and putty knife were used for the procedure;
3. One half of the sample was transferred to a large plastic freezer bag and sealed for subsequent vapour measurement and/or laboratory analysis (inorganic);
4. The duplicate portion of the sample for laboratory analyses (organic), was transferred to 120-mL ESS glass jars, which were filled to capacity with soil and fitted with screw down, Teflon™-lined lids; and
5. Laboratory samples were stored in insulated coolers with the appropriate chain of custody information and transported to the analytical laboratory for chemical analyses.



Soil Sampling Procedure: GeoProbe

Soil samples were collected continuously with the Geoprobe, as depicted on the borehole logs. The sampling procedure is as follows:

1. The core sample collection tube recovered using the Geoprobe was placed on a clean surface and the tube was split in half to expose the sample core. The sample collection tube was for one-time use only and was disposed of following sampling;
2. Using a clean pair of latex gloves and putty knife, samples were collected from the tube at various depth intervals;
3. One half of the sample was transferred to a large plastic freezer bag and sealed for subsequent vapour measurement and/or laboratory analysis (inorganic);
4. The duplicate portion of the sample for laboratory analyses (organic), was transferred to 120-mL ESS glass jars, which were filled to capacity with soil and fitted with screw down, Teflon™-lined lids; and
5. Laboratory samples were stored in insulated coolers with the appropriate chain of custody information and transported to the analytical laboratory for chemical analyses.

Soil Sampling Procedure: Excavation

Soil samples are collected using the bucket of the excavator within excavations that extend deeper than 1.5 m. Each sample location is measured for depth and tied into a common reference point (reference or 0,0 co-ordinate). Samples along the excavation walls are typically collected every 0.75 m vertically and every 4 m to 5 m horizontally, while base samples are collected every 5 m.

The standard sampling procedure is as follows:

1. Samples collected from the bucket of the excavator were collected using a clean pair of latex gloves and putty knife;
2. One half of the sample was transferred to a large plastic freezer bag and sealed for subsequent vapour measurement and/or laboratory analysis (inorganic);
3. The duplicate portion of the sample for laboratory analyses (organic), was transferred to 120-mL ESS glass jars, which were filled to capacity with soil and fitted with screw down, Teflon™-lined lids; and
4. Laboratory samples were stored in insulated coolers with the appropriate chain of custody information and transported to the analytical laboratory for chemical analyses.



METHANOL PRESERVATION

Under the British Columbia *Environmental Management Act* and the Saskatchewan *Environmental Management and Protection Act*, soil samples are collected in accordance with methodologies outlined by the USEPA (EPA 5035A). All soil samples analysed for benzene, toluene, ethylbenzene, xylenes (BTEX), petroleum hydrocarbon (PHC) Fractions 1 (C₆ to C₁₀ hydrocarbons), and/or volatile petroleum hydrocarbons (VPH), and volatile organic compounds (VOC) need to be preserved into methanol in the field immediately upon sampling. These samples are collected using a hermetic sampling device and preserved in methanol solution.

Field Sample Preparation & Procedure

1. Pre-weighed 40-mL septa seal glass vials with 10 mL methanol were obtained from a certified laboratory;
2. A visual inspection of each vial was completed to ensure that the volume of preservative in the vial is present to the prescribed fill-line of the vial;
3. At the desired sample location, approximately 3 to 5 cm of the soil surface was removed using a putty knife and discarded. A clean pair of latex gloves and putty knife were used for the procedure;
4. Using a hermetic sampling device, a 5-g soil core was immediately collected from the freshly exposed soil. Excess soil on the outer portion of the sampling device was wiped off with clean paper towel. Any excess soil protruding from the bottom of the sampler was cut off using a putty knife;
5. The soil core was deposited into a 40-mL septa seal glass vial with 10 mL of methanol preservative. The septa seal lid was screwed onto the vial to form a vapour lock. If necessary, the vial was inverted multiple times to ensure the soil core makes contact (is coated) with the methanol preservative;
6. Using the same hermetic sampling device, a second soil core was collected from the same freshly exposed soil as the first soil core and was preserved using the same methodology (step 3). Note: Both soil cores were collected and deposited into the methanol preservative within one minute or less. If any methanol solution was released (spilled) from the vial during sampling, the sample and vial were discarded and a new vial was used;
7. The hermetic sampling device was then discarded. A single new hermetic sampling device was used at each sampling location;
8. A subsequent soil sample was collected, as per procedures outlined, and one half of a duplicate portion of the sample for laboratory analyses was transferred to 120-mL ESS glass jars, which were filled to capacity with soil and fitted with screw down, Teflon™-lined lids;



9. The other half of the sample was transferred to a large plastic freezer bag and sealed for subsequent vapour measurement and/or laboratory analysis (inorganics); and
10. Laboratory samples were stored in insulated coolers at approximately 4°C with the appropriate chain of custody information and transported to the analytical laboratory for chemical analyses.

FIELD SCREENING

Hydrocarbon or Volatile Organic Compound Field Vapour Screening

Field subsoil samples are screened for organic vapour concentrations (OVCs) or hydrocarbon vapour concentrations (HVCs) using either a Photovac 2020 Photoionization Detector (PID) and/or equivalent detector (for VOCs), or a RKI Eagle or a Gastechtor 1238ME Hydrocarbon Surveyor (Gastech [for hydrocarbons only]). The detector is calibrated with a known standard as defined in the operators manual. The screening procedure is as follows:

1. The field samples (plastic bag) were allowed to warm-up in ambient temperature conditions (20°C) for approximately 30 minutes to facilitate the release of OVCs or HVCs into the air space within the sample bag. During the winter months the samples are placed below the truck heater to warm them; and
2. The airspace is then tested for OVCs or HVCs using the appropriate instrument. The measured OVCs or HVCs are expressed in parts-per-million by volume (ppmv).

Electrical Conductivity and Chloride Field Screening

Field soil samples are measured for electrical conductivity (EC) using a Fieldscout™ direct soil EC probe. The probe is inserted approximately 0.02 to 0.05 m into the soils at the designated depth at three separate locations and the average value is recorded. Soils which are too unconsolidated for effective use of the EC probe are measured for chloride using QuanTab® test strips. The strips are inserted into a 1:1 soil to deionized water mixture, and once fully absorbed with water an approximate concentration of chloride, measured in parts per million (ppm), can be determined.

NOTE: Additional soil samples may be collected for laboratory analysis on a project specific basis where numerous analyses are required. Soil bag samples may be collected where only trace metals analyses are to be conducted.

The above protocols were based on the following publications:

- Alberta Environment. 1996. Soil Monitoring Directive, Chemicals Assessment and Management Division, Environmental Regulatory Service;
- British Columbia Environmental Management Act. 2004;
- British Columbia Ministry of the Environment. 2014. Sample Holding Time and Sampling Requirements, as amended to November 2014;



- Canadian Council of Ministers of the Environment. 1994. Subsurface Assessment Handbook for Contaminated Sites, The National Contaminated Sites Remediation Program.
- Canadian Council of Ministers of the Environment. 2001. Reference Method of the Canada-Wide Standard of Petroleum Hydrocarbons in Soil - Tier 1 Method; and
- [EPA] United States Environmental Protection Agency. 2002. Test Methods to Evaluating Solid Waste, SW-846, Method 5035A: Closed-System-and-Trap and Extraction for Volatile Organics in Soil and Waste Samples.



SURFACE WATER SAMPLING METHODS

Surface water is any water body which exists above the surface of the ground. This may include lakes, reservoirs, rivers/streams, ponds, and pools. Unlike groundwater, which exists below the ground surface, surface water can be collected directly without requiring access through a well or subsurface excavation.

Any surface water sampling on or within 5 metres (m) of open water, or on ice, requires additional safety considerations. For safety considerations on open water, refer to the following standard operating procedure (SOP):

[\\10.0.0.180\data\Home\Health, Safety and Training\COR Audit\COR Elements\3 Hazard Control\Hazard Control Policies PDF\HC-20-SOW Safe Operations on Water.pdf](#)

For safety considerations on ice, refer the to following SOP:

[\\10.0.0.180\data\Home\Health, Safety and Training\COR Audit\COR Elements\3 Hazard Control\Hazard Control Policies PDF\HC-18-SOI Safe Operations on Ice.pdf](#)

General Sampling Methodology

Sampling water bodies is typically conducted for parameters such as petroleum hydrocarbons (PHCs), salinity, metals, volatile organic compounds (VOCs), polycyclic aromatic hydrocarbons (PAHs), or bacteriological parameters as a result of a spill or a contaminated site.

Water samples may be collection from shore, by wading into the water using hip waders, from a boat, or through the ice during winter. Depending on the scope of work for each project, sample collection methods are considered during development of the sampling program. For example, when sampling lakes, sampling from the shore may need to be avoided as shore sampling is not representative of the entire lake system. Sampling aids such as telescopic poles with attached sample collectors are typically utilized to collect samples up to 5 m from the shoreline. **The sampler should always be situated downstream of the sample collection point.**

To collect a surface water sample, follow the steps below:

1. Hold the sample bottle near its base and uncap the bottle;
2. Partially submerge the bottle, at arms length from your body and neck downward, and partially fill the bottle with surface water;
3. Fully submerge the bottle, and turn the bottle until the neck points slightly upwards with the opening directed toward the current; and
4. If the sample does not need preservative, cap the bottle while it is submerged, ensuring zero headspace if the laboratory requires this. If preservative is required, remove the bottle from the water and cap it after adding preservative, ensuring 0.5 cm of space from the top of the sample container to allow for possible water expansion and addition of the preservative. **Do not re-submerge the bottle once preservative has been added.**

In streams, sampling should occur in mid-stream, positioned downstream of the water flow.



When sampling a large water body such as a lake, composite sampling should be completed. Composite sampling allows for the average conditions of the water body to be represented in a single sample. The number of samples and the placement/spacing of such samples is project-specific and determined during scope development. The procedure for composite sampling is as follows:

1. A pre-cleaned intermediate sample bottle is rinsed three times with lake water prior to sample collection;
2. Fill the intermediate sample bottle using the same steps as outlined above;
3. Empty the water into a pre-designated sample bucket (appropriately pre-rinsed as per laboratory specifications); and
4. Continue sampling all designated sample locations within the lake using the above steps.

Samples should always be collected in an order starting from the “cleanest” to most impacted areas. For example, if using blanks, set these up first, then collect samples from the least impacted area to the most impacted area.

Ensure that collected samples are kept cool, ideally with ice packs in a cooler, for the duration of the sampling event and until they are delivered to the laboratory.

Sampling Through Ice

1. Clear the sample area of snow and dirt;
2. Auger a hole in the ice;
3. Ensure the area remains clear of snow and dirt;
4. Be very careful not to spill fuel on the ice auger as this may contaminate the sample location;
5. Once the hole is complete, clear all slush from the hole using a plastic sieve;
6. Allow several minutes prior to sampling to ensure water can flow freely, and allow potential contaminants from the auguring process to clear;
7. Collect samples in the same manner as outlined previously.

In Situ Measurements

Ideally, in situ field measurements should be collected during sampling, because parameters may change state during transport to and storage at the laboratory. Certain parameters, such as temperature, are very sensitive to external influences and will likely be different by the time they are measured in the laboratory. These parameters can all be captured using the TROLL[®] 9500 or SmarTROLL[™] multi-parameter meter, which collects field readings for pH, oxidation reduction potential (ORP), temperature, electrical conductivity (EC), and dissolved oxygen (DO). The following procedures should be followed for in-situ measurements using a multi-meter probe:

1. For water bodies <2 m deep, a measurement is collection at mid-depth. For water bodies >2 m deep, measurements are collection just below the water surface and at 1-m intervals down to 1 m above the bottom;
2. For each measurement, readings are collection every one to three minutes until stabilization occurs; and



3. If measuring at intervals, the probe is brought back to 1-m depth and recorded again once all interval measurements are complete. This acts as a field check on the instrument and verifies the accuracy of the first reading.

Stabilization of in situ parameters is characterized by three consecutive measurements which meet the following standards:

- pH = $\pm 10\%$ or ± 0.1 units;
- ORP = $\pm 10\%$ or ± 10 millivolts (mV);
- Temperature = $\pm 5\%$ or ± 0.5 C;
- EC = $\pm 10\%$ or ± 5 microSiemens per centimetre ($\mu\text{S}/\text{cm}$); and
- DO = $\pm 10\%$ or ± 0.2 milligrams per litre (mg/L).

Notes

- Always wear unpowdered latex or nitrile disposable gloves while sampling;
- Do not touch the cap or inside of the sample bottle;
- Keep caps on bottles prior to sampling;
- No smoking or eating while sampling;
- Avoid the use of insect repellent and hand/body lotions while sampling, or be very careful not to allow repellent to contact samples;
- Avoid submerged vegetation while sampling, and ensure that foreign materials do not enter samples;
- When sampling from a boat, always sample from the bow of the boat;
- Always sample at arms length to reduce any contamination from the boat/hip waders;
- When using a multi-parameter meter for in situ measurements, ensure that the meter is newly calibrated each day;
- **Do not use the multi-meter probe at temperatures outside the range of -5 to 50°C;**
- Ensure any equipment/probes have been rinsed/cleaned in between sample locations or after sampling has been completed at the location; and
- If sediment is disturbed, allow for the area to clear prior to collecting your sample.

Preservation/Field Filtering Methodology

Samples are collected in sample bottles specific to the type of chemical analysis being conducted. Some types of analysis require sample preservation with an acid or filtering of the sample in the field. Appropriate sample bottles and preservatives are provided by the analytical laboratory.

Review instructions and protocols required by the laboratory for the samples to be submitted for analysis. Leave 0.5 cm of space from the top of the sample bottle for potential water expansion and preservative when filling the sample, unless otherwise specified by the laboratory.



Organics

All organic samples are collected and preserved in glass bottles.

Benzene, toluene, ethylbenzene, xylenes (BTEX), and PHC Fraction 1 are collected in triplicate 40-mL clear glass vials with a penetrable septum and TeflonTM-lined lid. The samples are normally preserved with a sodium bisulphate tablet or with a preservative provided by the laboratory. PHC Fractions 2 through 4 are collected in a single 1-L amber bottle without preservative or in two 250-mL amber bottles with a sodium bisulphate tablet. Extractable petroleum hydrocarbons (EPH) are collected in two 60-mL amber glass vials, filled to the blue line on the vials and preserved with a sodium bisulphate tablet.

VOCs are collected in triplicate 40-mL clear glass vials with a penetrable septum and TeflonTM-lined lid. The samples are normally preserved with a sodium bisulphate tablet or with a preservative provided by the laboratory.

PAHs are collected in a single 500-mL (or larger) amber glass bottle and do not require preservative.

All organic sample bottles are filled to capacity with no headspace (excluding EPH as noted) and stored in coolers at approximately 4°C prior to and during transport to the analytical laboratory. If headspace is noted (bubbles larger than 1 mm are present), the sample is discarded, and a new sample is collected in a new sample container.

Surface water samples containing organic contaminants are not filtered.

Inorganics

Inorganic samples are collected and preserved (if necessary) in plastic bottles. The only exception to this may be for dissolved oxygen and mercury.

There are two accepted field practices for the collection of metals samples, depending on the type of analysis required. Dissolved metals analysis requires field filtering, followed by acidifying the sample. Field filtering requires attaching flexible watterra tubing to the filter and either running the tubing through a pump or attaching a funnel to the opposite end and filtering through gravity assist. Total/extractable metals analysis requires acidifying without field filtering.

Metals surface water samples are collected in 250 to 500-mL polyethylene bottles. The samples are preserved with 2 mL of 1:1 nitric acid.

All sample bottles are stored in coolers at approximately 4°C prior to and during transport to the analytical laboratory.



Bacteriological Sampling

These samples are collected to assess the sanitary quality of the water. Samples are typically analysed for fecal coliforms, *E. coli*, fecal streptococci or enterococci. Care is to be taken for potential contamination during sample collection. Only sterile lab-supplied bottles are to be used. Ensure sediment/substrate is not disturbed during sampling and that the procedures outlined above are followed.

References

- Alberta Environment and Parks (AEP). 2006. Aquatic Ecosystems Field Sampling Protocols. Environmental Monitoring and Evaluation Branch, Environmental Assurance Division (<http://environment.gov.ab.ca/info/library/7805.pdf>);
- Alberta Environment and Parks (AEP). 2014. Environmental Quality Guidelines for Alberta Surface Waters. Water Policy Branch, Policy Division;
- Alberta Environment and Parks (AEP). 2016. Alberta Tier 1 Soil and Groundwater Remediation Guidelines. Land and Forestry Policy Branch, Policy Division;
- British Columbia Ministry of the Environment (BCMOE). Field Sampling Manual, 2013. Ambient Freshwater and Effluent Sampling. (http://www2.gov.bc.ca/assets/gov/environment/research-monitoring-and-reporting/monitoring/emre/part_e.pdf); and
- Canadian Council of Ministers of the Environment (CCME). 2011. Protocols Manual for Water Quality Sampling in Canada. (http://www.ccme.ca/files/Resources/water/water_quality/protocols_document_e_final_101.pdf).

APPENDIX E

Report Transmission Cover Page

Bill To: City of Edmonton	Project:	Lot ID: 1165123
Report To: City of Edmonton	ID: 16-442-CRV	Control Number: C0098766
Engineering Services Building	Name:	Date Received: Oct 6, 2016
11004 – 190 Street NW	Location: Rainbow Valley Release	Date Reported: Dec 7, 2016
Edmonton, AB, Canada	LSD:	Report Number: 2154916
T5S 0G9	P.O.: 16-442-CRV	
Attn: Aaron Lewicki	Acct code: C-Release 4792006 Line	
Sampled By: KDG	23	
Company: NECL		

Contact & Affiliation	Address	Delivery Commitments
Accounts Payable	17331-107 Ave	On [Lot Approval and Final Test Report Approval] send
Nichols Environmental (Canada) Ltd	Edmonton, Alberta T5S 1E5	(Invoice, Invoice) by Email - Single Report
	Phone: (780) 484-3377	On [Lot Approval and Final Test Report Approval] send
	Fax: (780) 484-5093	(Invoice) by Email - Single Report
	Email: ap@nicholsenvironmental.com	
Barry Rakewich	17331-107 Ave NE	On [Lot Verification] send
Nichols Environmental (Canada) Ltd	Edmonton, Alberta T5S 1E5	(COA, COC) by Email - Merge Reports
	Phone: (780) 484-3377	On [Lot Verification] send
	Fax: (780) 484-5093	(COA, COC) by Email - Merge Reports
	Email: rakewich@nicholsenvironmental.com	On [Report Approval] send
		(Test Report) by Email - Single Report
		On [Report Approval] send
		(COC, Test Report) by Email - Merge Reports
		On [Report Approval] send
		(Test Report) by Email - Single Report
		On [Report Approval] send
		(COC, Test Report) by Email - Merge Reports
		On [Report Approval] send
		(Test Report) by Email - Single Report
		On [Report Approval] send
		(COC, Test Report) by Email - Merge Reports

Notes To Clients:

- Report was issued to include changes to the sample description for sample #3 from SA-01 to Resp-01 as requested by Barry Rakewich of Nichols on Dec 7th/16. Previous report 2138139.



Analytical Report

Bill To: City of Edmonton	Project:	Lot ID: 1165123
Report To: City of Edmonton	ID: 16-442-CRV	Control Number: C0098766
Engineering Services Building	Name:	Date Received: Oct 6, 2016
11004 – 190 Street NW	Location: Rainbow Valley Release	Date Reported: Dec 7, 2016
Edmonton, AB, Canada	LSD:	Report Number: 2154916
T5S 0G9	P.O.: 16-442-CRV	
Attn: Aaron Lewicki	Acct code: C-Release 4792006 Line	
Sampled By: KDG	23	
Company: NECL		

Reference Number	1165123-1
Sample Date	October 06, 2016
Sample Time	NA
Sample Location	
Sample Description	LF-01
Sample Matrix	Waste - industrial

Analyte	Units	Result	Nominal Detection Limit	Guideline Limit	Guideline Comments	
Leachate Inorganic - TCLP						
Antimony	TCLP Leachate	mg/L	<0.005	0.005	500	Below Limit
Arsenic	TCLP Leachate	mg/L	<0.002	0.002	5	Below Limit
Barium	TCLP Leachate	mg/L	0.92	0.05	100	Below Limit
Beryllium	TCLP Leachate	mg/L	<0.001	0.001	5	Below Limit
Boron	TCLP Leachate	mg/L	<0.2	0.2	500	Below Limit
Cadmium	TCLP Leachate	mg/L	0.004	0.001	1	Below Limit
Chromium	TCLP Leachate	mg/L	<0.005	0.005	5	Below Limit
Cobalt	TCLP Leachate	mg/L	0.012	0.001	100	Below Limit
Copper	TCLP Leachate	mg/L	<0.10	0.1	100	Below Limit
Iron	TCLP Leachate	mg/L	<0.1	0.1	1000	Below Limit
Lead	TCLP Leachate	mg/L	<0.050	0.05	5	Below Limit
Mercury	TCLP Leachate	mg/L	<0.001	0.001	0.2	Below Limit
Nickel	TCLP Leachate	mg/L	<0.050	0.050	5	Below Limit
Selenium	TCLP Leachate	mg/L	<0.002	0.002	1	Below Limit
Silver	TCLP Leachate	mg/L	<0.005	0.005	5	Below Limit
Thallium	TCLP Leachate	mg/L	<0.0005	0.0005	5	Below Limit
Uranium	TCLP Leachate	mg/L	<0.005	0.005	2.0	Below Limit
Vanadium	TCLP Leachate	mg/L	<0.01	0.01	100	Below Limit
Zinc	TCLP Leachate	mg/L	0.74	0.1	500	Below Limit
Zirconium	TCLP Leachate	mg/L	<0.01	0.01	500	Below Limit
pH	Initial		8.8			
pH	Final		5.3			
Salinity						
% Saturation		%	38			
Chloride	Saturated Paste	meq/L	5.30	0.06		
Chloride	Saturated Paste	mg/L	188	2		
Chloride	Saturated Paste	mg/kg	71			
Soil Acidity						
pH	1:2 Soil:Water	pH	8.6		2-12.5	Within Range
Waste Characterization						
Flash Point		°C	>75		61	Within Limit
Flash			No			
Paint Filter	Interpretation		Solid Waste			
Extractable Petroleum Hydrocarbons - Soil						
Extraction Date	Total Extractables		7-Oct-16			
F2c C10-C16	Dry Weight	mg/kg	<50	50		

Analytical Report

Bill To: City of Edmonton	Project:	Lot ID: 1165123
Report To: City of Edmonton	ID: 16-442-CRV	Control Number: C0098766
Engineering Services Building	Name:	Date Received: Oct 6, 2016
11004 – 190 Street NW	Location: Rainbow Valley Release	Date Reported: Dec 7, 2016
Edmonton, AB, Canada	LSD:	Report Number: 2154916
T5S 0G9	P.O.: 16-442-CRV	
Attn: Aaron Lewicki	Acct code: C-Release 4792006 Line	
Sampled By: KDG	23	
Company: NECL		

Reference Number	1165123-1
Sample Date	October 06, 2016
Sample Time	NA
Sample Location	
Sample Description	LF-01
Sample Matrix	Waste - industrial

Analyte	Units	Result	Nominal Detection Limit	Guideline Limit	Guideline Comments
Extractable Petroleum Hydrocarbons - Soil - Continued					
F3c C16-C34	Dry Weight	mg/kg	255	50	
F4c C34-C50	Dry Weight	mg/kg	194	100	
F4HTGCc C34-C50+	Dry Weight	mg/kg	344	100	
% C50+		%	17.5		
Mono-Aromatic Hydrocarbons - Soil					
Benzene	Dry Weight	mg/kg	<0.005	0.005	
Toluene	Dry Weight	mg/kg	<0.02	0.02	
Ethylbenzene	Dry Weight	mg/kg	<0.005	0.005	
Total Xylenes (m,p,o)	Dry Weight	mg/kg	<0.03	0.03	
Volatile Petroleum Hydrocarbons - Soil					
Extraction Date	Volatiles		7-Oct-16		
F1 C6-C10	Dry Weight	mg/kg	<10	10	
F1 -BTEX	Dry Weight	mg/kg	<10	10	
Mono-Aromatic Hydrocarbons - Leachate					
Benzene	TCLP Leachate	mg/L	<0.01	0.01	0.5
Toluene	TCLP Leachate	mg/L	<0.01	0.01	0.5
Ethylbenzene	TCLP Leachate	mg/L	<0.01	0.01	0.5
Total Xylenes (m,p,o)	TCLP Leachate	mg/L	<0.02	0.02	0.5
Soil % Moisture					
Moisture	Soil % Moisture	% by weight	25.40		



Analytical Report

Bill To: City of Edmonton	Project:	Lot ID: 1165123
Report To: City of Edmonton	ID: 16-442-CRV	Control Number: C0098766
Engineering Services Building	Name:	Date Received: Oct 6, 2016
11004 – 190 Street NW	Location: Rainbow Valley Release	Date Reported: Dec 7, 2016
Edmonton, AB, Canada	LSD:	Report Number: 2154916
T5S 0G9	P.O.: 16-442-CRV	
Attn: Aaron Lewicki	Acct code: C-Release 4792006 Line	
Sampled By: KDG	23	
Company: NECL		

Reference Number	1165123-2
Sample Date	October 06, 2016
Sample Time	NA
Sample Location	
Sample Description	SW-01
Sample Matrix	Water

Analyte	Units	Result	Nominal Detection Limit	Guideline Limit	Guideline Comments
Polycyclic Aromatic Hydrocarbons - Water					
Naphthalene	ug/L	<0.1	0.1		
Quinoline	ug/L	<0.3	0.3		
Acenaphthylene	ug/L	<0.1	0.1		
Acenaphthene	ug/L	<0.1	0.1		
Fluorene	ug/L	<0.1	0.1		
Phenanthrene	ug/L	<0.1	0.1		
Acridine	ug/L	<0.1	0.1		
Anthracene	ug/L	<0.005	0.005		
Fluoranthene	ug/L	<0.01	0.01		
Pyrene	ug/L	<0.01	0.01		
Benzo(a)anthracene	ug/L	<0.01	0.01		
Chrysene	ug/L	<0.1	0.1		
Benzo(b)fluoranthene	ug/L	<0.1	0.1		
Benzo(b+j)fluoranthene	ug/L	<0.1	0.1		
Benzo(k)fluoranthene	ug/L	<0.1	0.1		
Benzo(a)pyrene	ug/L	<0.008	0.008		
Indeno(1,2,3-c,d)pyrene	ug/L	<0.05	0.05		
Dibenzo(a,h)anthracene	ug/L	<0.05	0.05		
Benzo(g,h,i)perylene	ug/L	<0.05	0.05		
CB(a)P	Total Potency Equivalents	ug/L	<0.01	0.01	
Extractable Petroleum Hydrocarbons - Water					
F3 C16-C34	mg/L	<0.1	0.1		
F3+ C34+	mg/L	<0.1	0.1		
Mono-Aromatic Hydrocarbons - Water					
Benzene	mg/L	<0.001	0.001		
Toluene	mg/L	<0.0004	0.0004		
Ethylbenzene	mg/L	<0.0010	0.0010		
Total Xylenes (m,p,o)	mg/L	<0.001	0.001		
Volatile Petroleum Hydrocarbons - Water					
F1 -BTEX	mg/L	<0.1	0.1		
F1 C6-C10	mg/L	<0.1	0.1		
F2 C10-C16	mg/L	<0.1	0.1		
PAH - Water - Surrogate Recovery					
Nitrobenzene-d5	PAH - Surrogate	%	104	23-130	
2-Fluorobiphenyl	PAH - Surrogate	%	102	30-130	



Analytical Report

Bill To: City of Edmonton	Project:	Lot ID: 1165123
Report To: City of Edmonton	ID: 16-442-CRV	Control Number: C0098766
Engineering Services Building	Name:	Date Received: Oct 6, 2016
11004 – 190 Street NW	Location: Rainbow Valley Release	Date Reported: Dec 7, 2016
Edmonton, AB, Canada	LSD:	Report Number: 2154916
T5S 0G9	P.O.: 16-442-CRV	
Attn: Aaron Lewicki	Acct code: C-Release 4792006 Line	
Sampled By: KDG	23	
Company: NECL		

Reference Number	1165123-2
Sample Date	October 06, 2016
Sample Time	NA
Sample Location	
Sample Description	SW-01
Sample Matrix	Water

Analyte	Units	Result	Nominal Detection Limit	Guideline Limit	Guideline Comments
PAH - Water - Surrogate Recovery - Continued					
p-Terphenyl-d14	PAH - Surrogate	%	104	18-137	

Analytical Report

Bill To: City of Edmonton	Project:	Lot ID: 1165123
Report To: City of Edmonton	ID: 16-442-CRV	Control Number: C0098766
Engineering Services Building	Name:	Date Received: Oct 6, 2016
11004 – 190 Street NW	Location: Rainbow Valley Release	Date Reported: Dec 7, 2016
Edmonton, AB, Canada	LSD:	Report Number: 2154916
T5S 0G9	P.O.: 16-442-CRV	
Attn: Aaron Lewicki	Acct code: C-Release 4792006 Line	
Sampled By: KDG	23	
Company: NECL		

Reference Number	1165123-3
Sample Date	October 06, 2016
Sample Time	NA
Sample Location	
Sample Description	Resp-01
Sample Matrix	Soil

Analyte	Units	Result	Nominal Detection Limit	Guideline Limit	Guideline Comments
Polycyclic Aromatic Hydrocarbons - Soil					
Naphthalene	Dry Weight	mg/kg	1.54	0.010	
Acenaphthylene	Dry Weight	mg/kg	<0.05	0.05	
Acenaphthene	Dry Weight	mg/kg	0.47	0.05	
Fluorene	Dry Weight	mg/kg	1.59	0.05	
Phenanthrene	Dry Weight	mg/kg	1.00	0.01	
Anthracene	Dry Weight	mg/kg	<0.003	0.003	
Fluoranthene	Dry Weight	mg/kg	0.09	0.01	
Pyrene	Dry Weight	mg/kg	0.35	0.01	
Benzo(a)anthracene	Dry Weight	mg/kg	0.03	0.01	
Chrysene	Dry Weight	mg/kg	0.06	0.05	
Benzo(b+j)fluoranthene	Dry Weight	mg/kg	<0.05	0.05	
Benzo(k)fluoranthene	Dry Weight	mg/kg	<0.05	0.05	
Benzo(a)pyrene	Dry Weight	mg/kg	<0.05	0.05	
Indeno(1,2,3-c,d)pyrene	Dry Weight	mg/kg	<0.05	0.05	
Dibenzo(a,h)anthracene	Dry Weight	mg/kg	<0.05	0.05	
Benzo(g,h,i)perylene	Dry Weight	mg/kg	<0.05	0.05	
IACR_Coarse	Index of Additive Cancer Risk		0.028	0.001	
IACR_Fine	Index of Additive Cancer Risk		0.055	0.001	
Extractable Petroleum Hydrocarbons - Soil					
Extraction Date	Total Extractables		7-Oct-16		
F2c C10-C16	Dry Weight	mg/kg	6110	50	
F3c C16-C34	Dry Weight	mg/kg	9160	50	
F4c C34-C50	Dry Weight	mg/kg	585	100	
F4HTGCc C34-C50+	Dry Weight	mg/kg	655	100	
% C50+	%		<5		
Mono-Aromatic Hydrocarbons - Soil					
Benzene	Dry Weight	mg/kg	0.050	0.005	
Toluene	Dry Weight	mg/kg	1.46	0.02	
Ethylbenzene	Dry Weight	mg/kg	2.11	0.005	
Total Xylenes (m,p,o)	Dry Weight	mg/kg	14.2	0.03	
Volatile Petroleum Hydrocarbons - Soil					
Extraction Date	Volatiles		7-Oct-16		
F1 C6-C10	Dry Weight	mg/kg	347	10	
F1 -BTEX	Dry Weight	mg/kg	329	10	



Analytical Report

Bill To: City of Edmonton	Project:	Lot ID: 1165123
Report To: City of Edmonton	ID: 16-442-CRV	Control Number: C0098766
Engineering Services Building	Name:	Date Received: Oct 6, 2016
11004 – 190 Street NW	Location: Rainbow Valley Release	Date Reported: Dec 7, 2016
Edmonton, AB, Canada	LSD:	Report Number: 2154916
T5S 0G9	P.O.: 16-442-CRV	
Attn: Aaron Lewicki	Acct code: C-Release 4792006 Line	
Sampled By: KDG	23	
Company: NECL		

Reference Number	1165123-3
Sample Date	October 06, 2016
Sample Time	NA
Sample Location	
Sample Description	Resp-01
Sample Matrix	Soil

Analyte		Units	Result	Nominal Detection Limit	Guideline Limit	Guideline Comments
PAH - Soil - Surrogate Recovery						
Nitrobenzene-d5	PAH - Surrogate	%	>130	23-130		
2-Fluorobiphenyl	PAH - Surrogate	%	110	30-130		
p-Terphenyl-d14	PAH - Surrogate	%	99	18-137		
Soil % Moisture						
Moisture	Soil % Moisture	% by weight	14.80			

Approved by: 

Anthony Neumann, MSc
Laboratory Operations Manager

Data have been validated by Analytical Quality Control and Exova's Integrated Data Validation System (IDVS).

Generation and distribution of the report, and approval by the digitized signature above, are performed through a secure and controlled automatic process.



Quality Control

Bill To: City of Edmonton	Project:	Lot ID: 1165123
Report To: City of Edmonton	ID: 16-442-CRV	Control Number: C0098766
Engineering Services Building	Name:	Date Received: Oct 6, 2016
11004 – 190 Street NW	Location: Rainbow Valley Release	Date Reported: Dec 7, 2016
Edmonton, AB, Canada	LSD:	Report Number: 2154916
T5S 0G9	P.O.: 16-442-CRV	
Attn: Aaron Lewicki	Acct code: C-Release 4792006 Line	
Sampled By: KDG	23	
Company: NECL		

Extractable Petroleum Hydrocarbons - Soil

Blanks	Units	Measured	Lower Limit	Upper Limit	Passed QC
F2c C10-C16	ug/mL	0	-10	10	yes
F3c C16-C34	ug/mL	0	-30	30	yes
F4c C34-C50	ug/mL	0	-20	20	yes
F4HTGCc C34-C50+	ug/mL	0	-20	20	yes

Date Acquired: October 07, 2016

Calibration Check	Units	% Recovery	Lower Limit	Upper Limit	Passed QC
F2c C10-C16	ug/mL	102.50	85	115	yes
F3c C16-C34	ug/mL	103.95	85	115	yes
F4c C34-C50	ug/mL	98.37	85	115	yes
F4HTGCc C34-C50+	ug/mL	92.73	85	115	yes

Date Acquired: October 07, 2016

Extractable Petroleum Hydrocarbons - Water

Blanks	Units	Measured	Lower Limit	Upper Limit	Passed QC
F2 C10-C16	ug/mL	0	-0.2	0.2	yes
F3 C16-C34	ug/mL	0	-0.2	0.2	yes
F3+ C34+	ug/mL	0	-0.2	0.2	yes

Date Acquired: October 07, 2016

Calibration Check	Units	% Recovery	Lower Limit	Upper Limit	Passed QC
F2 C10-C16	ug/mL	103.13	85	115	yes
F3 C16-C34	ug/mL	106.04	85	115	yes
F3+ C34+	ug/mL	92.34	85	115	yes

Date Acquired: October 07, 2016

Leachate Inorganic - TCLP

Blanks	Units	Measured	Lower Limit	Upper Limit	Passed QC
Antimony	ug/L	0.0407441	-0.501	0.501	yes
Arsenic	ug/L	0.0301144	-0.201	0.201	yes
Barium	ug/L	0.101023	-5.01	5.01	yes
Beryllium	ug/L	0.00713243	-0.099	0.099	yes
Boron	ug/L	0.929094	-20.0	20.0	yes
Cadmium	ug/L	0.0363477	-0.0990	0.0990	yes
Chromium	ug/L	-0.0923192	-0.501	0.501	yes
Cobalt	ug/L	0.020977	-0.099	0.099	yes
Copper	ug/L	1.7232	-9.99	9.99	yes
Iron	ug/L	4.67895	-10.0	10.0	yes
Lead	ug/L	0.0572471	-5.010	5.010	yes
Mercury	ug/L	0.00171735	-0.0990	0.0990	yes
Nickel	ug/L	0.0828652	-0.501	0.501	yes
Selenium	ug/L	0.0340116	-0.201	0.201	yes



Quality Control

Bill To: City of Edmonton
Report To: City of Edmonton
Engineering Services Building
11004 – 190 Street NW
Edmonton, AB, Canada
T5S 0G9
Attn: Aaron Lewicki
Sampled By: KDG
Company: NECL

Project:
ID: 16-442-CRV
Name:
Location: Rainbow Valley Release
LSD:
P.O.: 16-442-CRV
Acct code: C-Release 4792006 Line 23

Lot ID: **1165123**
Control Number: C0098766
Date Received: Oct 6, 2016
Date Reported: Dec 7, 2016
Report Number: 2154916

Leachate Inorganic - TCLP - Continued

Blanks	Units	Measured	Lower Limit	Upper Limit	Passed QC
Silver	ug/L	0.00226956	-0.501	0.501	yes
Thallium	ug/L	0.00201915	-0.0501	0.0501	yes
Uranium	ug/L	0.0104427	-0.501	0.501	yes
Vanadium	ug/L	-0.041753	-1.00	1.00	yes
Zinc	ug/L	7.17045	-9.99	9.99	yes
Zirconium	ug/L	0.000722876	-0.99	0.99	yes

Date Acquired: October 07, 2016

Client Sample Replicates	Units	Replicate 1	Replicate 2	% RSD Criteria	Absolute Criteria	Passed QC
Antimony	mg/L	<0.005	<0.005	20	0.008	yes
Arsenic	mg/L	<0.002	<0.002	20	0.008	yes
Barium	mg/L	0.27	0.25	20	0.04	yes
Beryllium	mg/L	<0.001	<0.001	20	0.004	yes
Boron	mg/L	<0.2	<0.2	20	0.1	yes
Cadmium	mg/L	<0.001	<0.001	20	0.0004	yes
Chromium	mg/L	<0.005	<0.005	20	0.020	yes
Cobalt	mg/L	<0.001	<0.001	20	0.004	yes
Copper	mg/L	<0.10	<0.10	20	0.04	yes
Iron	mg/L	<0.1	<0.1	20	0.4	yes
Lead	mg/L	<0.050	<0.050	20	0.004	yes
Nickel	mg/L	<0.050	<0.050	20	0.020	yes
Selenium	mg/L	<0.002	<0.002	20	0.008	yes
Silver	mg/L	<0.005	<0.005	20	0.004	yes
Thallium	mg/L	<0.0005	<0.0005	20	0.0020	yes
Uranium	mg/L	<0.005	<0.005	20	0.020	yes
Vanadium	mg/L	<0.01	<0.01	20	0.00	yes
Zinc	mg/L	<0.10	<0.10	20	0.04	yes
Zirconium	mg/L	<0.01	<0.01	20	0.04	yes
pH		6.4	6.4	0	0.3	yes

Date Acquired: October 07, 2016

Control Sample	Units	Measured	Lower Limit	Upper Limit	Passed QC
Antimony	mg/L	0.041	0.036	0.044	yes
Arsenic	mg/L	0.041	0.037	0.043	yes
Barium	mg/L	0.21	0.19	0.22	yes
Beryllium	mg/L	0.020	0.018	0.021	yes
Boron	mg/L	0.4	0.4	0.4	yes
Cadmium	mg/L	0.0020	0.0019	0.0022	yes
Chromium	mg/L	0.105	0.095	0.107	yes
Cobalt	mg/L	0.020	0.018	0.022	yes
Iron	mg/L	4.1	3.7	4.4	yes
Lead	mg/L	0.019	0.019	0.021	yes
Mercury	mg/L	0.0031	0.0027	0.0033	yes
Nickel	mg/L	0.104	0.090	0.110	yes



Quality Control

Bill To: City of Edmonton	Project:	Lot ID: 1165123
Report To: City of Edmonton	ID: 16-442-CRV	Control Number: C0098766
Engineering Services Building	Name:	Date Received: Oct 6, 2016
11004 – 190 Street NW	Location: Rainbow Valley Release	Date Reported: Dec 7, 2016
Edmonton, AB, Canada	LSD:	Report Number: 2154916
T5S 0G9	P.O.: 16-442-CRV	
Attn: Aaron Lewicki	Acct code: C-Release 4792006 Line	
Sampled By: KDG	23	
Company: NECL		

Leachate Inorganic - TCLP - Continued

Control Sample	Units	Measured	Lower Limit	Upper Limit	Passed QC
Selenium	mg/L	0.042	0.037	0.043	yes
Silver	mg/L	0.019	0.018	0.022	yes
Thallium	mg/L	0.0098	0.0092	0.0108	yes
Uranium	mg/L	0.100	0.089	0.109	yes
Vanadium	mg/L	0.02	0.02	0.02	yes
Zinc	mg/L	0.21	0.18	0.22	yes

Date Acquired: October 07, 2016

Mono-Aromatic Hydrocarbons - Leachate

Blanks	Units	Measured	Lower Limit	Upper Limit	Passed QC
Benzene	ng	0	-9.99	9.99	yes
Toluene	ng	0	-9.99	9.99	yes
Ethylbenzene	ng	0	-9.99	9.99	yes
m,p-Xylene	ng	0	-9.99	9.99	yes
o-Xylene	ng	0	-9.99	9.99	yes

Date Acquired: October 07, 2016

Calibration Check	Units	% Recovery	Lower Limit	Upper Limit	Passed QC
Benzene	ng	99.22	85	115	yes
Toluene	ng	107.71	85	115	yes
Ethylbenzene	ng	103.26	85	115	yes
m,p-Xylene	ng	104.54	85	115	yes
o-Xylene	ng	102.71	85	115	yes

Date Acquired: October 07, 2016

Client Sample Replicates	Units	Replicate 1	Replicate 2	% RSD Criteria	Absolute Criteria	Passed QC
Benzene	mg/L	<0.01	<0.01	20	10.00	yes
Toluene	mg/L	<0.01	<0.01	20	10.00	yes
Ethylbenzene	mg/L	0.01	0.01	20	10.00	yes
m,p-Xylene	mg/L	0.09	0.09	20	10.00	yes
o-Xylene	mg/L	0.04	0.05	20	10.00	yes

Date Acquired: October 07, 2016

Mono-Aromatic Hydrocarbons - Soil

Blanks	Units	Measured	Lower Limit	Upper Limit	Passed QC
Benzene	ng	0	-0.005	0.005	yes
Toluene	ng	0	-0.06	0.06	yes
Ethylbenzene	ng	0	-0.030	0.030	yes
Total Xylenes (m,p,o)	ng	0	-0.09	0.09	yes
Styrene	ng	0	-0.030	0.030	yes

Date Acquired: October 07, 2016

Calibration Check	Units	% Recovery	Lower Limit	Upper Limit	Passed QC
Benzene	ng	86.80	85	115	yes



Quality Control

Bill To: City of Edmonton	Project:	Lot ID: 1165123
Report To: City of Edmonton	ID: 16-442-CRV	Control Number: C0098766
Engineering Services Building	Name:	Date Received: Oct 6, 2016
11004 – 190 Street NW	Location: Rainbow Valley Release	Date Reported: Dec 7, 2016
Edmonton, AB, Canada	LSD:	Report Number: 2154916
T5S 0G9	P.O.: 16-442-CRV	
Attn: Aaron Lewicki	Acct code: C-Release 4792006 Line	
Sampled By: KDG	23	
Company: NECL		

Mono-Aromatic Hydrocarbons - Soil -

Continued

Calibration Check	Units	% Recovery	Lower Limit	Upper Limit	Passed QC
Toluene	ng	85.80	85	115	yes
Ethylbenzene	ng	93.00	85	115	yes
Total Xylenes (m,p,o)	ng	97.33	85	115	yes
Styrene	ng	89.60	85	115	yes

Date Acquired: October 07, 2016

Client Sample Replicates	Units	Replicate 1	Replicate 2	% RSD Criteria	Absolute Criteria	Passed QC
Benzene	mg/kg	<0.005	<0.005	50	0.010	yes
Toluene	mg/kg	<0.02	<0.02	50	0.04	yes
Ethylbenzene	mg/kg	<0.005	<0.005	50	0.020	yes
m,p-Xylene	mg/kg	<0.02	<0.02	50	0.04	yes
o-Xylene	mg/kg	<0.02	<0.02	50	0.04	yes
Total Xylenes (m,p,o)	mg/kg	<0.03	<0.03	50	0.06	yes
Styrene	mg/kg	<0.01	<0.01	50	0.020	yes

Date Acquired: October 07, 2016

Mono-Aromatic Hydrocarbons - Water

Blanks	Units	Measured	Lower Limit	Upper Limit	Passed QC
Benzene	ng	0	-0.002	0.002	yes
Toluene	ng	0	-0.0015	0.0015	yes
Ethylbenzene	ng	0	-0.0015	0.0015	yes
Total Xylenes (m,p,o)	ng	0	-0.002	0.002	yes
Styrene	ng	0	-0.002	0.002	yes

Date Acquired: October 07, 2016

Calibration Check	Units	% Recovery	Lower Limit	Upper Limit	Passed QC
Benzene	ng	103.60	85	115	yes
Toluene	ng	97.60	85	115	yes
Ethylbenzene	ng	95.60	85	115	yes
Total Xylenes (m,p,o)	ng	96.67	85	115	yes
Styrene	ng	95.80	85	115	yes

Date Acquired: October 07, 2016

PAH - Soil - Surrogate Recovery

Blanks	Units	Measured	Lower Limit	Upper Limit	Passed QC
Nitrobenzene-d5	%	92.71	23	130	yes
2-Fluorobiphenyl	%	95.91	30	130	yes
p-Terphenyl-d14	%	119.13	18	137	yes

Date Acquired: October 07, 2016

PAH - Water - Surrogate Recovery

Blanks	Units	Measured	Lower Limit	Upper Limit	Passed QC
--------	-------	----------	-------------	-------------	-----------



Quality Control

Bill To: City of Edmonton	Project:	Lot ID: 1165123
Report To: City of Edmonton	ID: 16-442-CRV	Control Number: C0098766
Engineering Services Building	Name:	Date Received: Oct 6, 2016
11004 – 190 Street NW	Location: Rainbow Valley Release	Date Reported: Dec 7, 2016
Edmonton, AB, Canada	LSD:	Report Number: 2154916
T5S 0G9	P.O.: 16-442-CRV	
Attn: Aaron Lewicki	Acct code: C-Release 4792006 Line	
Sampled By: KDG	23	
Company: NECL		

PAH - Water - Surrogate Recovery

Blanks	Units	Measured	Lower Limit	Upper Limit	Passed QC
Nitrobenzene-d5	%	106.93	23	130	yes
2-Fluorobiphenyl	%	103.5	30	130	yes
p-Terphenyl-d14	%	115.65	18	137	yes
Date Acquired: October 07, 2016					

Polycyclic Aromatic Hydrocarbons - Soil

Blanks	Units	Measured	Lower Limit	Upper Limit	Passed QC
Naphthalene	ng/mL	0	-0.010	0.010	yes
Acenaphthylene	ng/mL	0	-0.05	0.05	yes
Acenaphthene	ng/mL	0	-0.05	0.05	yes
Fluorene	ng/mL	0	-0.05	0.05	yes
Phenanthrene	ng/mL	0	-0.01	0.01	yes
Anthracene	ng/mL	0	-0.003	0.003	yes
Fluoranthene	ng/mL	0	-0.01	0.01	yes
Pyrene	ng/mL	0	-0.01	0.01	yes
Benzo(a)anthracene	ng/mL	0	-0.01	0.01	yes
Chrysene	ng/mL	0	-0.05	0.05	yes
Benzo(b)fluoranthene	ng/mL	0	-0.05	0.05	yes
Benzo(b+j)fluoranthene	ng/mL	0	-0.05	0.05	yes
Benzo(k)fluoranthene	ng/mL	0	-0.05	0.05	yes
Benzo(a)pyrene	ng/mL	0	-0.05	0.05	yes
Indeno(1,2,3-c,d)pyrene	ng/mL	0	-0.05	0.05	yes
Dibenzo(a,h)anthracene	ng/mL	0	-0.05	0.05	yes
Benzo(g,h,i)perylene	ng/mL	0	-0.05	0.05	yes
Date Acquired: October 07, 2016					

Calibration Check	Units	% Recovery	Lower Limit	Upper Limit	Passed QC
Naphthalene	ng/mL	100.20	80	120	yes
Acenaphthylene	ng/mL	98.20	80	120	yes
Acenaphthene	ng/mL	101.40	80	120	yes
Fluorene	ng/mL	101.80	80	120	yes
Phenanthrene	ng/mL	102.80	80	120	yes
Anthracene	ng/mL	98.80	80	120	yes
Fluoranthene	ng/mL	100.40	80	120	yes
Pyrene	ng/mL	100.20	80	120	yes
Benzo(a)anthracene	ng/mL	96.80	80	120	yes
Chrysene	ng/mL	98.40	80	120	yes
Benzo(b)fluoranthene	ng/mL	99.60	80	120	yes
Benzo(k)fluoranthene	ng/mL	101.00	80	120	yes
Benzo(a)pyrene	ng/mL	100.00	80	120	yes
Indeno(1,2,3-c,d)pyrene	ng/mL	112.00	80	120	yes
Dibenzo(a,h)anthracene	ng/mL	109.20	80	120	yes
Benzo(g,h,i)perylene	ng/mL	110.20	80	120	yes



Quality Control

Bill To: City of Edmonton	Project:	Lot ID: 1165123
Report To: City of Edmonton	ID: 16-442-CRV	Control Number: C0098766
Engineering Services Building	Name:	Date Received: Oct 6, 2016
11004 – 190 Street NW	Location: Rainbow Valley Release	Date Reported: Dec 7, 2016
Edmonton, AB, Canada	LSD:	Report Number: 2154916
T5S 0G9	P.O.: 16-442-CRV	
Attn: Aaron Lewicki	Acct code: C-Release 4792006 Line	
Sampled By: KDG	23	
Company: NECL		

Polycyclic Aromatic Hydrocarbons - Soil - Continued

Calibration Check	Units	% Recovery	Lower Limit	Upper Limit	Passed QC
Date Acquired:	October 07, 2016				

Polycyclic Aromatic Hydrocarbons - Water

Blanks	Units	Measured	Lower Limit	Upper Limit	Passed QC
Naphthalene	ng/mL	0	-0.1	0.1	yes
Quinoline	ng/mL	0	-0.1	0.1	yes
Acenaphthylene	ng/mL	0	-0.1	0.1	yes
Acenaphthene	ng/mL	0	-0.1	0.1	yes
Fluorene	ng/mL	0	-0.1	0.1	yes
Phenanthrene	ng/mL	0	-0.1	0.1	yes
Acridine	ng/mL	0	-0.1	0.1	yes
Anthracene	ng/mL	0	-0.005	0.005	yes
Fluoranthene	ng/mL	0	-0.01	0.01	yes
Pyrene	ng/mL	0	-0.01	0.01	yes
Benzo(a)anthracene	ng/mL	0	-0.01	0.01	yes
Chrysene	ng/mL	0	-0.1	0.1	yes
Benzo(b)fluoranthene	ng/mL	0	-0.1	0.1	yes
Benzo(b+j)fluoranthene	ng/mL	0	-0.1	0.1	yes
Benzo(k)fluoranthene	ng/mL	0	-0.1	0.1	yes
Benzo(a)pyrene	ng/mL	0	-0.008	0.008	yes
Indeno(1,2,3-c,d)pyrene	ng/mL	0	-0.05	0.05	yes
Dibenzo(a,h)anthracene	ng/mL	0	-0.05	0.05	yes
Benzo(g,h,i)perylene	ng/mL	0	-0.05	0.05	yes

Date Acquired: October 07, 2016

Calibration Check	Units	% Recovery	Lower Limit	Upper Limit	Passed QC
Naphthalene	ng/mL	100.20	80	120	yes
Quinoline	ng/mL	94.67	80	120	yes
Acenaphthylene	ng/mL	98.20	80	120	yes
Acenaphthene	ng/mL	101.40	80	120	yes
Fluorene	ng/mL	101.80	80	120	yes
Phenanthrene	ng/mL	102.80	80	120	yes
Acridine	ng/mL	93.60	80	120	yes
Anthracene	ng/mL	98.80	80	120	yes
Fluoranthene	ng/mL	100.40	80	120	yes
Pyrene	ng/mL	100.20	80	120	yes
Benzo(a)anthracene	ng/mL	96.80	80	120	yes
Chrysene	ng/mL	98.40	80	120	yes
Benzo(b)fluoranthene	ng/mL	99.60	80	120	yes
Benzo(b+j)fluoranthene	ng/mL	99.60	80	120	yes
Benzo(k)fluoranthene	ng/mL	101.00	80	120	yes



Quality Control

Bill To: City of Edmonton	Project:	Lot ID: 1165123
Report To: City of Edmonton	ID: 16-442-CRV	Control Number: C0098766
Engineering Services Building	Name:	Date Received: Oct 6, 2016
11004 – 190 Street NW	Location: Rainbow Valley Release	Date Reported: Dec 7, 2016
Edmonton, AB, Canada	LSD:	Report Number: 2154916
T5S 0G9	P.O.: 16-442-CRV	
Attn: Aaron Lewicki	Acct code: C-Release 4792006 Line	
Sampled By: KDG	23	
Company: NECL		

Polycyclic Aromatic Hydrocarbons -

Water - Continued

Calibration Check	Units	% Recovery	Lower Limit	Upper Limit	Passed QC
Benzo(a)pyrene	ng/mL	100.00	80	120	yes
Indeno(1,2,3-c,d)pyrene	ng/mL	112.00	80	120	yes
Dibenzo(a,h)anthracene	ng/mL	109.20	80	120	yes
Benzo(g,h,i)perylene	ng/mL	110.20	80	120	yes

Date Acquired: October 07, 2016

Salinity

Blanks	Units	Measured	Lower Limit	Upper Limit	Passed QC
Chloride	mg/L	2.7947	0	5	yes

Date Acquired: October 07, 2016

Control Sample	Units	Measured	Lower Limit	Upper Limit	Passed QC
Electrical Conductivity	dS/m	2.90	2.71	3.25	yes
% Saturation	%	48	38	52	yes
Chloride	mg/L	68	57	78	yes

Date Acquired: October 07, 2016

Electrical Conductivity	dS/m	31.6	26.80	35.20	yes
Chloride	mg/L	2050	1871	2231	yes

Date Acquired: October 07, 2016

Soil Acidity

Blanks	Units	Measured	Lower Limit	Upper Limit	Passed QC
pH	pH	6.54	5.3	7.2	yes

Date Acquired: October 07, 2016

Client Sample Replicates	Units	Replicate 1	Replicate 2	% RSD Criteria	Absolute Criteria	Passed QC
pH	pH	8.8	8.8	0	0.3	yes

Date Acquired: October 07, 2016

Control Sample	Units	Measured	Lower Limit	Upper Limit	Passed QC
pH	pH	7.3	6.3	8.5	yes

Date Acquired: October 07, 2016

Volatile Petroleum Hydrocarbons - Soil

Blanks	Units	Measured	Lower Limit	Upper Limit	Passed QC
F1 C6-C10	ng	0	-10	10	yes

Date Acquired: October 07, 2016

Client Sample Replicates	Units	Replicate 1	Replicate 2	% RSD Criteria	Absolute Criteria	Passed QC
F1 C6-C10	mg/kg	<10	<10	50	0	yes
F1 -BTEX	mg/kg	<10	<10	50	0	yes

Date Acquired: October 07, 2016

Matrix Spike	Units	% Recovery	Lower Limit	Upper Limit	Passed QC
--------------	-------	------------	-------------	-------------	-----------



Quality Control

Bill To: City of Edmonton	Project:	Lot ID: 1165123
Report To: City of Edmonton	ID: 16-442-CRV	Control Number: C0098766
Engineering Services Building	Name:	Date Received: Oct 6, 2016
11004 – 190 Street NW	Location: Rainbow Valley Release	Date Reported: Dec 7, 2016
Edmonton, AB, Canada	LSD:	Report Number: 2154916
T5S 0G9	P.O.: 16-442-CRV	
Attn: Aaron Lewicki	Acct code: C-Release 4792006 Line	
Sampled By: KDG	23	
Company: NECL		

Volatile Petroleum Hydrocarbons - Soil -

Continued

Matrix Spike	Units	% Recovery	Lower Limit	Upper Limit	Passed QC
F1 C6-C10	mg/kg	90	80	120	yes
Date Acquired: October 07, 2016					

Volatile Petroleum Hydrocarbons - Water

Blanks	Units	Measured	Lower Limit	Upper Limit	Passed QC
F1 -BTEX	ng	0	-0.3	0.3	yes
F1 C6-C10	ng	0	-0.300	0.300	yes
F2 C10-C16	ng	0	-0.3	0.3	yes
Date Acquired: October 07, 2016					
Calibration Check	Units	% Recovery	Lower Limit	Upper Limit	Passed QC
F2 C10-C16	ng	80.50	80	120	yes
Date Acquired: October 07, 2016					

Waste Characterization

Control Sample	Units	Measured	Lower Limit	Upper Limit	Passed QC
Flash Point	°C	52	50	55	yes
Date Acquired: October 07, 2016					

Methodology and Notes

Bill To: City of Edmonton	Project:	Lot ID: 1165123
Report To: City of Edmonton	ID: 16-442-CRV	Control Number: C0098766
Engineering Services Building	Name:	Date Received: Oct 6, 2016
11004 – 190 Street NW	Location: Rainbow Valley Release	Date Reported: Dec 7, 2016
Edmonton, AB, Canada	LSD:	Report Number: 2154916
T5S 0G9	P.O.: 16-442-CRV	
Attn: Aaron Lewicki	Acct code: C-Release 4792006 Line	
Sampled By: KDG	23	
Company: NECL		

Method of Analysis

Method Name	Reference	Method	Date Analysis Started	Location
BTEX-CCME - Soil	CCME	* Reference Method for Canada-Wide Standard for PHC in Soil, CWS PHCS TIER 1	07-Oct-16	Exova Calgary
BTEX-CCME - Soil	US EPA	* Volatile Organic Compounds in Various Sample Matrices Using Equilibrium Headspace Analysis/Gas Chromatography Mass Spectrometry, 5021/8260	07-Oct-16	Exova Calgary
BTEX-CCME - Water	US EPA	* Volatile Organic Compounds in Various Sample Matrices Using Equilibrium Headspace Analysis/Gas Chromatography Mass Spectrometry, 5021/8260	07-Oct-16	Exova Calgary
Flash Point (Closed cup)	ASTM	Standard Test Methods for Flash Point by Pensky-Martens Closed Cup Tester - Procedure B, D 93-15a	07-Oct-16	Exova Edmonton
Leachate Inorganic (TCLP) ICP-MS	US EPA	* Toxicity Characteristic Leaching Procedure, SW-846, EPA 1311	07-Oct-16	Exova Edmonton
Leachate Organic (TCLP-BTEX)	US EPA	* Toxicity Characteristic Leaching Procedure, SW-846, EPA 1311	07-Oct-16	Exova Edmonton
PAH - Soil	AESRD	Index of Additive Cancer Risk (IACR), PAHs	07-Oct-16	Exova Calgary
PAH - Soil	US EPA	* Semivolatile Organic Compounds by Gas Chromatography/Mass Spectrometry, 8270	07-Oct-16	Exova Calgary
PAH - Water	AESRD	Carcinogenic PAHs Toxic Potency Equivalence (as B(a)P TPE), PAHw	07-Oct-16	Exova Calgary
PAH - Water	US EPA	* Semivolatile Organic Compounds by Gas Chromatography/Mass Spectrometry, 8270	07-Oct-16	Exova Calgary
Paint Filter Liquids Test	US EPA	* Paint Filter Liquids Test, 9095B	07-Oct-16	Exova Edmonton
pH and Conductivity in general soil 1:2	McKeague	* 1:2 Soil:Water Ratio, 4.12	07-Oct-16	Exova Edmonton
Saturated Paste in General Soil	APHA	* Automated Ferricyanide Method, 4500-Cl-E	07-Oct-16	Exova Edmonton
Saturated Paste in General Soil	Carter	* Electrical Conductivity and Soluble Ions, Chapter 15	07-Oct-16	Exova Edmonton
TEH-CCME - Water	EPA/CCME	* Separatory Funnel Liquid-liquid Extraction/CCME, EPA 3510/CCME	07-Oct-16	Exova Calgary
TEH-CCME-Soil (Shake)	CCME	* Reference Method for Canada-Wide Standard for PHC in Soil, CWS PHCS TIER 1	07-Oct-16	Exova Calgary

* Reference Method Modified

References

AESRD Alberta Tier 1 Soil and Groundwater Remediation Guidelines



Methodology and Notes

Bill To:	City of Edmonton	Project:		Lot ID:	1165123
Report To:	City of Edmonton	ID:	16-442-CRV	Control Number:	C0098766
	Engineering Services Building	Name:		Date Received:	Oct 6, 2016
	11004 – 190 Street NW	Location:	Rainbow Valley Release	Date Reported:	Dec 7, 2016
	Edmonton, AB, Canada	LSD:		Report Number:	2154916
	T5S 0G9	P.O.:	16-442-CRV		
Attn:	Aaron Lewicki	Acct code:	C-Release 4792006 Line		
Sampled By:	KDG		23		
Company:	NECL				

APHA	Standard Methods for the Examination of Water and Wastewater
ASTM	Annual Book of ASTM Standards
Carter	Soil Sampling and Methods of Analysis.
CCME	Canadian Council of Ministers of the Environment
EPA/CCME	Environmental Protection Agency Test Methods - US/CCME
McKeague	Manual on Soil Sampling and Methods of Analysis
US EPA	US Environmental Protection Agency Test Methods

Guidelines

Guideline Description	Class 2 Landfill (AB)
Guideline Source	AENV Waste Control Regulation, Alberta Regulation 192/96
Guideline Comments	Limits for analytes that may be required for Class 2 Landfill Acceptance may not be presented in this report. Consult the AENV Waste Control Regulation for hazardous waste limits, and ERCB D058 for dangerous oilfield waste properties.

Comments:

- Report was issued to include changes to the sample description for sample #3 from SA-01 to Resp-01 as requested by Barry Rakewich of Nichols on Dec 7th/16. Previous report 2138139.

The comparison of test results to guideline limits is provided for information purposes only. This is not to be taken as a statement of conformance / nonconformance to any guideline, regulation or limit. The data user is responsible for all conclusions drawn with respect to the data and is advised to consult official regulatory references when evaluating compliance.

Please direct any inquiries regarding this report to our Client Services group.
Results relate only to samples as submitted.

The test report shall not be reproduced except in full, without the written approval of the laboratory.

Hydrocarbon Chromatogram

Bill To: Nichols Environmental (Canada)	Project ID: 16-442-CRV	Lot ID: 1165123
Report To: Nichols Environmental (Canada)	Name:	Control Number: C0098766
17331-107 Ave NE	Location: Edmonton, AB	Date Received: Oct 6, 2016
Edmonton, AB, Canada	LSD:	Date Reported: Oct 7, 2016
T5S 1E5	P.O.: {Project ID}	Report Number: 2138139
Attn: Barry Rakewich		
Sampled by: KDG		
Company: NECL		

Exova Number: 1165123-1
 Sample Date: Oct 6, 2016

Sample Description: LF-01

Silica Gel Treated

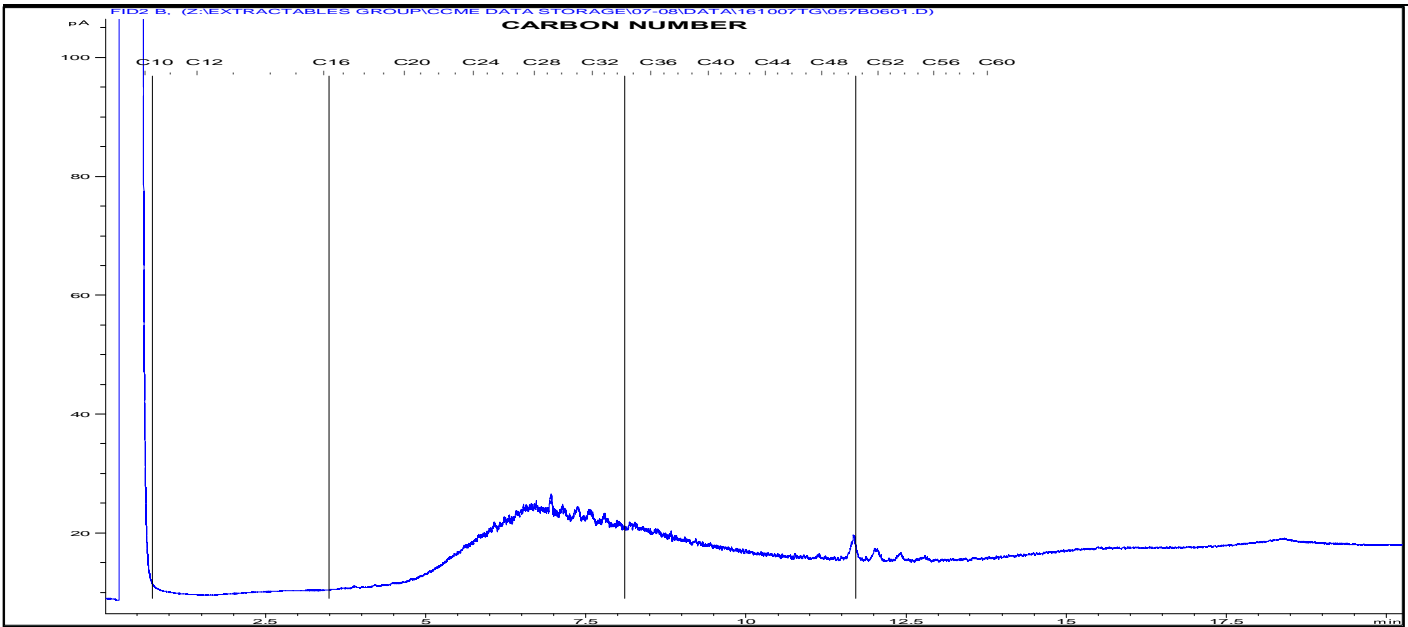

TYPICAL PRODUCT CHROMATOGRAMS

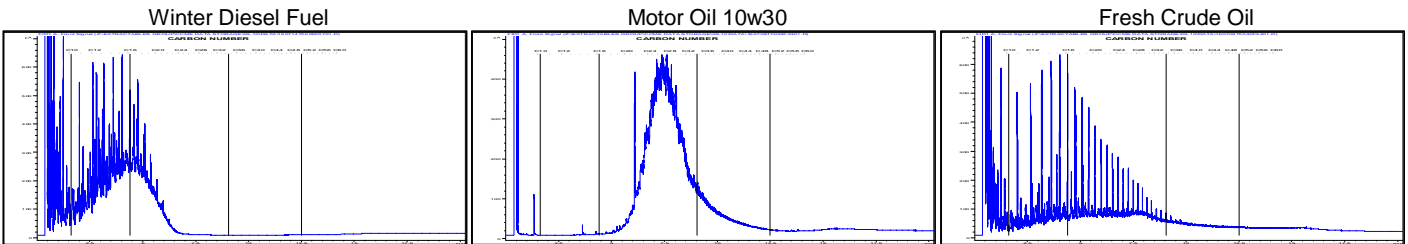

Product Carbon Number Ranges

Gasoline	C4-C12	Kerosene	C7-C16	Lubricating Oils	C20-C40
Varsol	C8-C12	Diesel	C8-C22	Crude Oils	C3-C60+



Hydrocarbon Chromatogram

Bill To: Nichols Environmental (Canada)	Project ID: 16-442-CRV	Lot ID: 1165123
Report To: Nichols Environmental (Canada)	Name:	Control Number: C0098766
17331-107 Ave NE	Location: Edmonton, AB	Date Received: Oct 6, 2016
Edmonton, AB, Canada	LSD:	Date Reported: Oct 7, 2016
T5S 1E5	P.O.: {Project ID}	Report Number: 2138139
Attn: Barry Rakewich		
Sampled by: KDG		
Company: NECL		

Exova Number: 1165123-2 Sample Description: SW-01
 Sample Date: Oct 6, 2016

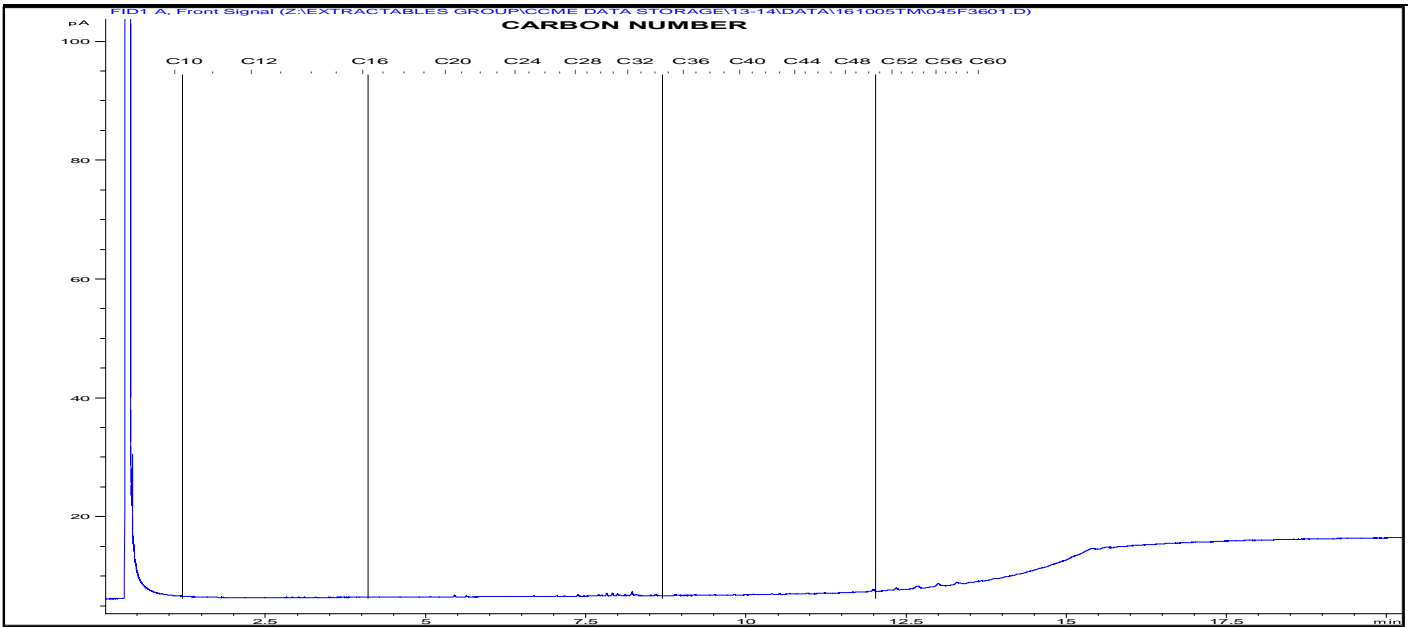

TYPICAL PRODUCT CHROMATOGRAMS

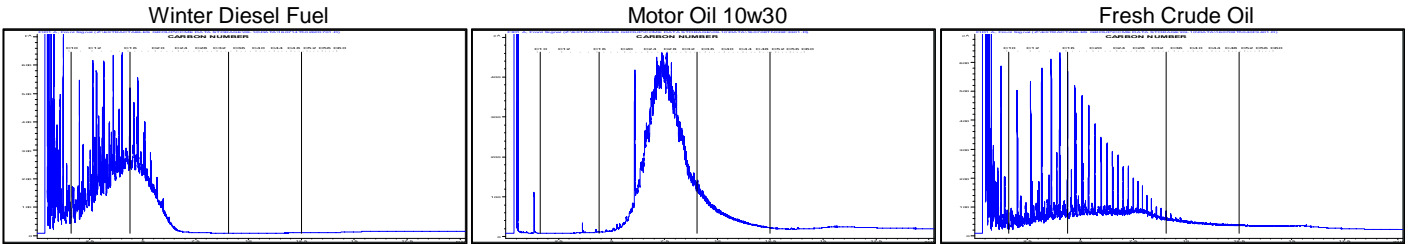

Product Carbon Number Ranges

Gasoline	C4-C12	Kerosene	C7-C16	Lubricating Oils	C20-C40
Varsol	C8-C12	Diesel	C8-C22	Crude Oils	C3-C60+

Hydrocarbon Chromatogram

Bill To: Nichols Environmental (Canada)	Project ID: 16-442-CRV	Lot ID: 1165123
Report To: Nichols Environmental (Canada)	Name:	Control Number: C0098766
17331-107 Ave NE	Location: Edmonton, AB	Date Received: Oct 6, 2016
Edmonton, AB, Canada	LSD:	Date Reported: Oct 9, 2016
T5S 1E5	P.O.: {Project ID}	Report Number: 2138139
Attn: Barry Rakewich		
Sampled by: KDG		
Company: NECL		

Exova Number: 1165123-3
 Sample Date: Oct 6, 2016

Sample Description: SA-01

Silica Gel Treated

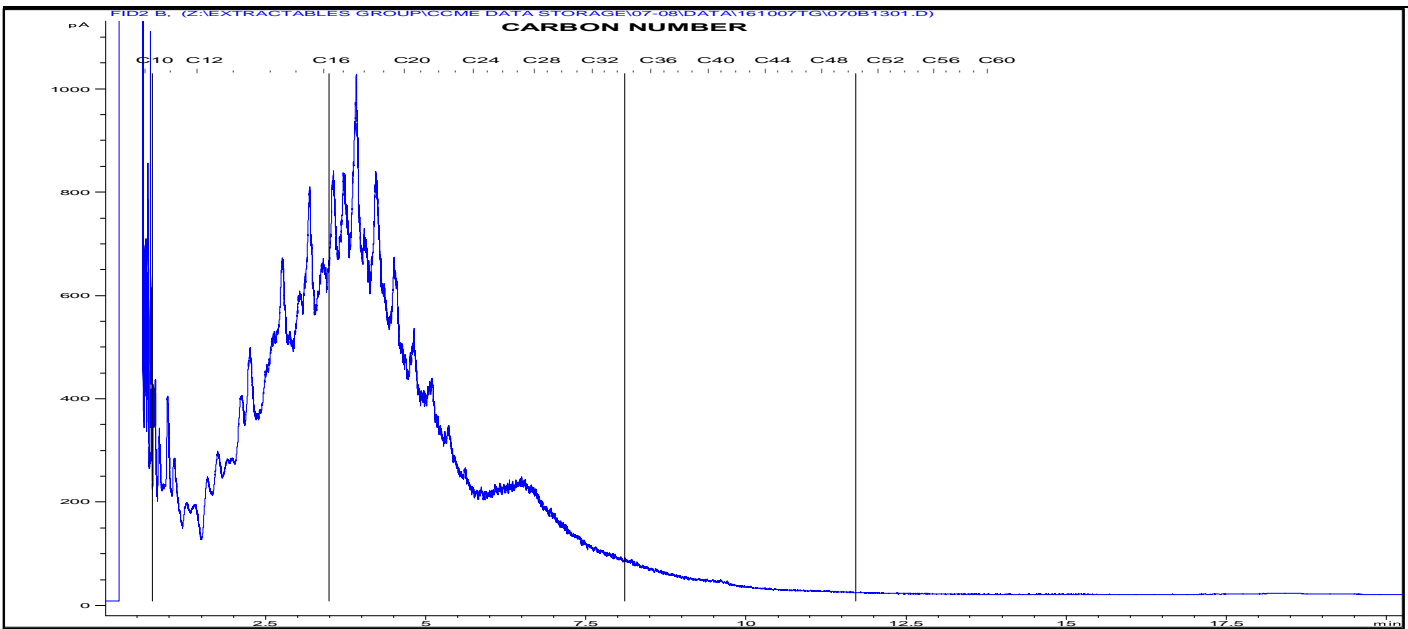

TYPICAL PRODUCT CHROMATOGRAMS

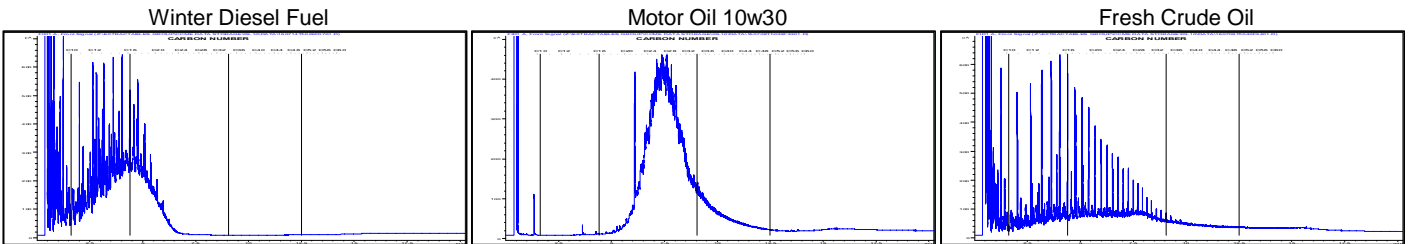

Product Carbon Number Ranges

Gasoline	C4-C12	Kerosene	C7-C16	Lubricating Oils	C20-C40
Varsol	C8-C12	Diesel	C8-C22	Crude Oils	C3-C60+

Invoice to:		Report To:		Report Results	Regulatory Requirement
Company:	Nichols Env.	Company:		E-Mail	X HCDWQG
Address:	17331-107 Ave	Address:	Same as	Mail	X Ab Tier 1
Attention:	Barry Rakavich	Attention:	"invoice to:"	Online	SPIGEC
Phone:	780-484-3377	Phone:		Fax	BCCSR
Cell:		Cell:		PDF	X Other (list below)
Fax:		Fax:		Excel	X
E-mail:	rakavich@nicholsenv.com	E-mail 1:		QA/QC	X
Agreement ID:	mental.com	E-mail 2:		Sample Custody (please print)	
Copy of report:		Copy of invoice:		Sampled by: KDG	

RUSH Priority

Emergency (contact lab for turnaround and pricing)	When "ASAP" is requested, turn around will default to a 100% RUSH priority, with pricing and turn around time to match. Please contact the lab prior to submitting RUSH samples. If not all samples require RUSH, please indicate in the special instructions.
Priority 1-2 working days (100% surcharge)	
Urgent 2-3 working days (50% surcharge)	

Date Required: _____ Signature: _____

Special Instructions/Comments (please include contact information including ph. # if different from above).

LF 01 + SW-01 - 100% SA-01 - Reg. TAT

Number of Containers	Classified for	
	CCMEW	
	PAH	
	100% RUSH	
	CCMEC	
	PAH	

Company: NECL

This section for Lab use only

Date/Time stamp:
OCT 6 PM 9:20

Site I.D.	Sample Description	Depth start end in cm m	Date/Time Sampled	Matrix	Sampling Method	Enter tests above (√ relevant samples below)	Indicate in the space allotted any deficiencies by the corresponding number.
1	LF-01		Oct 6-16	Soil grab	4	X X X	1. Indicate any samples that were not packaged well
2	SW-01			water grab	5	X X X	2. Indicate any received in Ex
3	SA-01			Soil grab	2	X X	3. Indicate any were not clea
4							4. Indicate any received with hold time or t
5							5. Indicate any extra sample
6							6. Indicate any were receive
7							7. Indicate any samples where sufficient volume was not received
8							8. Indicate any samples received in an inappropriate container
9							
10							
11							
12							
13							
14							
15							

Submission of this form acknowledges acceptance of Exova's Standard Terms and Conditions (<http://www.exova.com/about/terms-and-conditions/>)

Please indicate any potentially hazardous samples

Page 1 of 1 Control # **C 0098766**

Indicate lot # or affix barcode here: **1165123**

Shipping: COD Y/ N

and size of coolers

Temp. received: **3.9** Delivery Method: **Drop Box**

Waybill:

Received by: **vw**



ED 120-02

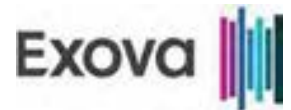

Report Transmission Cover Page

Bill To: City of Edmonton	Project:	Lot ID: 1165424
Report To: Nichols Environmental (Canada)	ID: 16-442-CRV	Control Number: C0099579
17331-107 Ave NE	Name: Remediation	Date Received: Oct 7, 2016
Edmonton, AB, Canada	Location:	Date Reported: Oct 20, 2016
T5S 1E5	LSD: Rainbow Valley Road	Report Number: 2141514
Attn: Barry Rakewich	P.O.: 16-442-CRV	
Sampled By: MH	Acct code: C-Release 4792006	
Company: Nichols	LINE 23	

Contact & Affiliation	Address	Delivery Commitments
Accounts Payable Nichols Environmental (Canada) Ltd	17331-107 Ave Edmonton, Alberta T5S 1E5 Phone: (780) 484-3377 Fax: (780) 484-5093 Email: ap@nicholsenvironmental.com	On [Lot Approval and Final Test Report Approval] send (Invoice) by Email - Single Report On [Lot Approval and Final Test Report Approval] send (Invoice) by Email - Single Report On [Lot Approval and Final Test Report Approval] send (Invoice, Invoice) by Email - Single Report On [Lot Approval and Final Test Report Approval] send (Invoice) by Email - Single Report
Barry Rakewich Nichols Environmental (Canada) Ltd	17331-107 Ave NE Edmonton, Alberta T5S 1E5 Phone: (780) 484-3377 Fax: (780) 484-5093 Email: rakewich@nicholsenvironmental.com	On [Lot Verification] send (COA, COC) by Email - Merge Reports On [Lot Verification] send (COA, COC) by Email - Merge Reports On [Report Approval] send (Test Report) by Email - Single Report On [Report Approval] send (Test Report) by Email - Single Report On [Report Approval] send (COC, Test Report) by Email - Merge Reports On [Report Approval] send (Test Report, COC) by Email - Merge Reports On [Report Approval] send (Test Report) by Email - Single Report On [Report Approval] send (Test Report, COC) by Email - Merge Reports
Michael Harquail Nichols Environmental (Canada) Ltd	17331-107 Ave NE Edmonton, Alberta T5S 1E5 Phone: (780) 484-3377 Fax: (780) 484-5093 Email: Harquail@nicholsenvironmental.com	On [Report Approval] send (Test Report, COC) by Email - Merge Reports On [Report Approval] send (Test Report) by Email - Single Report On [Report Approval] send (Test Report, COC) by Email - Merge Reports On [Report Approval] send (Test Report) by Email - Single Report

The information contained on this and all other pages transmitted, is intended for the addressee only and is considered confidential. If the reader is not the intended recipient, you are hereby notified that any use, dissemination, distribution or copy of this transmission is strictly prohibited. If you receive this transmission by error, or if this transmission is not satisfactory, please notify us by telephone.

Report Transmission Cover Page

Bill To: City of Edmonton	Project:	Lot ID: 1165424
Report To: Nichols Environmental (Canada)	ID: 16-442-CRV	Control Number: C0099579
17331-107 Ave NE	Name: Remediation	Date Received: Oct 7, 2016
Edmonton, AB, Canada	Location:	Date Reported: Oct 20, 2016
T5S 1E5	LSD: Rainbow Valley Road	Report Number: 2141514
Attn: Barry Rakewich	P.O.: 16-442-CRV	
Sampled By: MH	Acct code: C-Release 4792006	
Company: Nichols	LINE 23	

Contact & Affiliation	Address	Delivery Commitments
	17331-107 Ave NE	On [Report Approval] send
	Edmonton, Alberta T5S 1E5	(Test Report, COC) by Email - Merge Reports
	Phone: (780) 484-3377	On [Report Approval] send
	Fax: (780) 484-5093	(Test Report) by Email - Single Report
	Email: Harquail@nicholsenvironmental.com	

Notes To Clients:

- Report was issued to include addition of PAH analysis on samples 1-5 requested by Michael Harquail of Nichols Environmental on Oct.18, 2016. Previous report #2138544.



Analytical Report

Bill To: City of Edmonton	Project:	Lot ID: 1165424
Report To: Nichols Environmental (Canada)	ID: 16-442-CRV	Control Number: C0099579
17331-107 Ave NE	Name: Remediation	Date Received: Oct 7, 2016
Edmonton, AB, Canada	Location:	Date Reported: Oct 20, 2016
T5S 1E5	LSD: Rainbow Valley Road	Report Number: 2141514
Attn: Barry Rakewich	P.O.: 16-442-CRV	
Sampled By: MH	Acct code: C-Release 4792006	
Company: Nichols	LINE 23	

	Reference Number	1165424-1	1165424-2	1165424-3		
	Sample Date	Oct 07, 2016	Oct 07, 2016	Oct 07, 2016		
	Sample Time	NA	NA	NA		
	Sample Location					
	Sample Description	SA-01 / 0.05 / m	SA-12 / 0.05 / m	SA-18 / 1.8 / m		
	Matrix	Soil	Soil	Soil		
Analyte	Units	Results	Results	Results	Nominal Detection Limit	
Mono-Aromatic Hydrocarbons - Soil						
Benzene	Dry Weight	mg/kg	<0.005	<0.005	<0.005	0.005
Toluene	Dry Weight	mg/kg	<0.02	<0.02	<0.02	0.02
Ethylbenzene	Dry Weight	mg/kg	<0.005	<0.005	<0.005	0.005
Total Xylenes (m,p,o)	Dry Weight	mg/kg	<0.03	<0.03	<0.03	0.03
Volatile Petroleum Hydrocarbons - Soil						
Extraction Date	Volatiles		11-Oct-16	11-Oct-16	11-Oct-16	
F1 C6-C10	Dry Weight	mg/kg	<10	<10	<10	10
F1 -BTEX	Dry Weight	mg/kg	<10	<10	<10	10
Extractable Petroleum Hydrocarbons - Soil						
Extraction Date	Total Extractables		11-Oct-16	11-Oct-16	11-Oct-16	
F2c C10-C16	Dry Weight	mg/kg	<50	<50	<50	50
F3c C16-C34	Dry Weight	mg/kg	311	113	66	50
F4c C34-C50	Dry Weight	mg/kg	<100	<100	<100	100
F4HTGCc C34-C50+	Dry Weight	mg/kg	102	<100	<100	100
% C50+	%		<5	<5	<5	
Silica Gel Cleanup						
Silica Gel Cleanup			Done	Done	Done	
Soil % Moisture						
Moisture	Soil % Moisture	% by weight	27.10	29.80	17.20	
Polycyclic Aromatic Hydrocarbons - Soil						
Naphthalene	Dry Weight	mg/kg	<0.010	<0.010	<0.010	0.010
Acenaphthylene	Dry Weight	mg/kg	<0.05	<0.05	<0.05	0.05
Acenaphthene	Dry Weight	mg/kg	<0.05	<0.05	<0.05	0.05
Fluorene	Dry Weight	mg/kg	<0.05	<0.05	<0.05	0.05
Phenanthrene	Dry Weight	mg/kg	0.03	0.01	0.01	0.01
Anthracene	Dry Weight	mg/kg	0.009	<0.003	<0.003	0.003
Fluoranthene	Dry Weight	mg/kg	0.07	<0.01	<0.01	0.01
Pyrene	Dry Weight	mg/kg	0.07	<0.01	0.01	0.01
Benzo(a)anthracene	Dry Weight	mg/kg	0.03	<0.01	<0.01	0.01
Chrysene	Dry Weight	mg/kg	<0.05	<0.05	<0.05	0.05
Benzo(b+j)fluoranthene	Dry Weight	mg/kg	<0.05	<0.05	<0.05	0.05
Benzo(k)fluoranthene	Dry Weight	mg/kg	<0.05	<0.05	<0.05	0.05
Benzo(a)pyrene	Dry Weight	mg/kg	<0.05	<0.05	<0.05	0.05
Indeno(1,2,3-c,d)pyrene	Dry Weight	mg/kg	<0.05	<0.05	<0.05	0.05
Dibenzo(a,h)anthracene	Dry Weight	mg/kg	<0.05	<0.05	<0.05	0.05
Benzo(g,h,i)perylene	Dry Weight	mg/kg	<0.05	<0.05	<0.05	0.05



Analytical Report

Bill To: City of Edmonton	Project:	Lot ID: 1165424
Report To: Nichols Environmental (Canada)	ID: 16-442-CRV	Control Number: C0099579
17331-107 Ave NE	Name: Remediation	Date Received: Oct 7, 2016
Edmonton, AB, Canada	Location:	Date Reported: Oct 20, 2016
T5S 1E5	LSD: Rainbow Valley Road	Report Number: 2141514
Attn: Barry Rakewich	P.O.: 16-442-CRV	
Sampled By: MH	Acct code: C-Release 4792006	
Company: Nichols	LINE 23	

	Reference Number	1165424-1	1165424-2	1165424-3	
	Sample Date	Oct 07, 2016	Oct 07, 2016	Oct 07, 2016	
	Sample Time	NA	NA	NA	
	Sample Location				
	Sample Description	SA-01 / 0.05 / m	SA-12 / 0.05 / m	SA-18 / 1.8 / m	
	Matrix	Soil	Soil	Soil	
Analyte	Units	Results	Results	Results	Nominal Detection Limit
Polycyclic Aromatic Hydrocarbons - Soil - Continued					
IACR_Coarse	Index of Additive Cancer Risk	0.017	<0.001	0.004	0.001
IACR_Fine	Index of Additive Cancer Risk	0.032	<0.001	0.009	0.001
PAH - Soil - Surrogate Recovery					
Nitrobenzene-d5	PAH - Surrogate %	117	101	97	23-130
2-Fluorobiphenyl	PAH - Surrogate %	107	102	95	30-130
p-Terphenyl-d14	PAH - Surrogate %	111	108	97	18-137



Analytical Report

Bill To: City of Edmonton	Project:	Lot ID: 1165424
Report To: Nichols Environmental (Canada)	ID: 16-442-CRV	Control Number: C0099579
17331-107 Ave NE	Name: Remediation	Date Received: Oct 7, 2016
Edmonton, AB, Canada	Location:	Date Reported: Oct 20, 2016
T5S 1E5	LSD: Rainbow Valley Road	Report Number: 2141514
Attn: Barry Rakewich	P.O.: 16-442-CRV	
Sampled By: MH	Acct code: C-Release 4792006	
Company: Nichols	LINE 23	

Reference Number	1165424-2
Sample Date	Oct 07, 2016
Sample Time	NA
Sample Location	
Sample Description	SA-12 / 0.05 / m
Matrix	Soil

Analyte	Units	Results	Results	Results	Nominal Detection Limit
Particle Size Analysis - Wet Sieve					
Texture		Fine-Grained			
75 micron sieve	% Retained	% by weight	17.9		0.1



Analytical Report

Bill To: City of Edmonton	Project:	Lot ID: 1165424
Report To: Nichols Environmental (Canada)	ID: 16-442-CRV	Control Number: C0099579
17331-107 Ave NE	Name: Remediation	Date Received: Oct 7, 2016
Edmonton, AB, Canada	Location:	Date Reported: Oct 20, 2016
T5S 1E5	LSD: Rainbow Valley Road	Report Number: 2141514
Attn: Barry Rakewich	P.O.: 16-442-CRV	
Sampled By: MH	Acct code: C-Release 4792006	
Company: Nichols	LINE 23	

	Reference Number	1165424-4	1165424-5	1165424-6		
	Sample Date	Oct 07, 2016	Oct 07, 2016	Oct 07, 2016		
	Sample Time	NA	NA	NA		
	Sample Location					
	Sample Description	SA-22 / 1.0 / m	SA-23 / 0.15 / m	SA-27 / 0.05 / m		
	Matrix	Soil	Soil	Soil		
Analyte	Units	Results	Results	Results	Nominal Detection Limit	
Mono-Aromatic Hydrocarbons - Soil						
Benzene	Dry Weight	mg/kg	<0.005	<0.005	<0.005	0.005
Toluene	Dry Weight	mg/kg	<0.02	<0.02	<0.02	0.02
Ethylbenzene	Dry Weight	mg/kg	<0.005	<0.005	<0.005	0.005
Total Xylenes (m,p,o)	Dry Weight	mg/kg	<0.03	<0.03	<0.03	0.03
Volatile Petroleum Hydrocarbons - Soil						
Extraction Date	Volatiles		11-Oct-16	11-Oct-16	11-Oct-16	
F1 C6-C10	Dry Weight	mg/kg	<10	<10	<10	10
F1 -BTEX	Dry Weight	mg/kg	<10	<10	<10	10
Extractable Petroleum Hydrocarbons - Soil						
Extraction Date	Total Extractables		11-Oct-16	11-Oct-16	11-Oct-16	
F2c C10-C16	Dry Weight	mg/kg	74	<50	<50	50
F3c C16-C34	Dry Weight	mg/kg	643	55	91	50
F4c C34-C50	Dry Weight	mg/kg	364	<100	<100	100
F4HTGCc C34-C50+	Dry Weight	mg/kg	815	<100	<100	100
% C50+		%	20.8	<5	<5	
Silica Gel Cleanup						
Silica Gel Cleanup			Done	Done	Done	
Soil % Moisture						
Moisture	Soil % Moisture	% by weight	22.80	22.40	30.70	
Polycyclic Aromatic Hydrocarbons - Soil						
Naphthalene	Dry Weight	mg/kg	0.036	0.019	<0.010	0.010
Acenaphthylene	Dry Weight	mg/kg	<0.05	<0.05	<0.05	0.05
Acenaphthene	Dry Weight	mg/kg	<0.05	<0.05	<0.05	0.05
Fluorene	Dry Weight	mg/kg	0.13	<0.05	<0.05	0.05
Phenanthrene	Dry Weight	mg/kg	0.44	0.02	<0.01	0.01
Anthracene	Dry Weight	mg/kg	0.018	<0.003	<0.003	0.003
Fluoranthene	Dry Weight	mg/kg	0.06	<0.01	<0.01	0.01
Pyrene	Dry Weight	mg/kg	0.12	<0.01	0.01	0.01
Benzo(a)anthracene	Dry Weight	mg/kg	0.03	<0.01	<0.01	0.01
Chrysene	Dry Weight	mg/kg	0.05	<0.05	<0.05	0.05
Benzo(b+j)fluoranthene	Dry Weight	mg/kg	<0.05	<0.05	<0.05	0.05
Benzo(k)fluoranthene	Dry Weight	mg/kg	<0.05	<0.05	<0.05	0.05
Benzo(a)pyrene	Dry Weight	mg/kg	<0.05	<0.05	<0.05	0.05
Indeno(1,2,3-c,d)pyrene	Dry Weight	mg/kg	<0.05	<0.05	<0.05	0.05
Dibenzo(a,h)anthracene	Dry Weight	mg/kg	<0.05	<0.05	<0.05	0.05
Benzo(g,h,i)perylene	Dry Weight	mg/kg	<0.05	<0.05	<0.05	0.05



Analytical Report

Bill To: City of Edmonton	Project:	Lot ID: 1165424
Report To: Nichols Environmental (Canada)	ID: 16-442-CRV	Control Number: C0099579
17331-107 Ave NE	Name: Remediation	Date Received: Oct 7, 2016
Edmonton, AB, Canada	Location:	Date Reported: Oct 20, 2016
T5S 1E5	LSD: Rainbow Valley Road	Report Number: 2141514
Attn: Barry Rakewich	P.O.: 16-442-CRV	
Sampled By: MH	Acct code: C-Release 4792006	
Company: Nichols	LINE 23	

	Reference Number	1165424-4	1165424-5	1165424-6	
	Sample Date	Oct 07, 2016	Oct 07, 2016	Oct 07, 2016	
	Sample Time	NA	NA	NA	
	Sample Location				
	Sample Description	SA-22 / 1.0 / m	SA-23 / 0.15 / m	SA-27 / 0.05 / m	
	Matrix	Soil	Soil	Soil	
Analyte	Units	Results	Results	Results	Nominal Detection Limit
Polycyclic Aromatic Hydrocarbons - Soil - Continued					
IACR_Coarse	Index of Additive Cancer Risk	0.020	<0.001	<0.001	0.001
IACR_Fine	Index of Additive Cancer Risk	0.040	<0.001	0.001	0.001
PAH - Soil - Surrogate Recovery					
Nitrobenzene-d5	PAH - Surrogate %	87	109	123	23-130
2-Fluorobiphenyl	PAH - Surrogate %	87	101	104	30-130
p-Terphenyl-d14	PAH - Surrogate %	91	105	124	18-137



Analytical Report

Bill To: City of Edmonton	Project:	Lot ID: 1165424
Report To: Nichols Environmental (Canada)	ID: 16-442-CRV	Control Number: C0099579
17331-107 Ave NE	Name: Remediation	Date Received: Oct 7, 2016
Edmonton, AB, Canada	Location:	Date Reported: Oct 20, 2016
T5S 1E5	LSD: Rainbow Valley Road	Report Number: 2141514
Attn: Barry Rakewich	P.O.: 16-442-CRV	
Sampled By: MH	Acct code: C-Release 4792006	
Company: Nichols	LINE 23	

Reference Number	1165424-7
Sample Date	Oct 07, 2016
Sample Time	NA
Sample Location	
Sample Description	SW-02
Matrix	Water

Analyte	Units	Results	Results	Results	Nominal Detection Limit
Mono-Aromatic Hydrocarbons - Water					
Benzene	mg/L	<0.001			0.001
Toluene	mg/L	<0.0004			0.0004
Ethylbenzene	mg/L	<0.0010			0.0010
Total Xylenes (m,p,o)	mg/L	<0.001			0.001
Volatile Petroleum Hydrocarbons - Water					
F1 -BTEX	mg/L	<0.1			0.1
F1 C6-C10	mg/L	<0.1			
F2 C10-C16	mg/L	<0.1			0.1
Extractable Petroleum Hydrocarbons - Water					
F3 C16-C34	mg/L	<0.1			0.1
F3+ C34+	mg/L	<0.1			0.1
Polycyclic Aromatic Hydrocarbons - Water					
Naphthalene	ug/L	<0.1			0.1
Quinoline	ug/L	<0.3			0.3
Acenaphthylene	ug/L	<0.1			0.1
Acenaphthene	ug/L	<0.1			0.1
Fluorene	ug/L	<0.1			0.1
Phenanthrene	ug/L	<0.1			0.1
Acridine	ug/L	<0.1			0.1
Anthracene	ug/L	<0.005			0.005
Fluoranthene	ug/L	<0.01			0.01
Pyrene	ug/L	<0.01			0.01
Benzo(a)anthracene	ug/L	<0.01			0.01
Chrysene	ug/L	<0.1			0.1
Benzo(b)fluoranthene	ug/L	<0.1			0.1
Benzo(b+j)fluoranthene	ug/L	<0.1			0.1
Benzo(k)fluoranthene	ug/L	<0.1			0.1
Benzo(a)pyrene	ug/L	<0.008			0.008
Indeno(1,2,3-c,d)pyrene	ug/L	<0.05			0.05
Dibenzo(a,h)anthracene	ug/L	<0.05			0.05
Benzo(g,h,i)perylene	ug/L	<0.05			0.05
CB(a)P	Carcinogenic Potency Equivalent	ug/L	<0.01		0.01
PAH - Water - Surrogate Recovery					
Nitrobenzene-d5	PAH - Surrogate	%	104		23-130
2-Fluorobiphenyl	PAH - Surrogate	%	94		30-130



Analytical Report

Bill To: City of Edmonton	Project:	Lot ID: 1165424
Report To: Nichols Environmental (Canada)	ID: 16-442-CRV	Control Number: C0099579
17331-107 Ave NE	Name: Remediation	Date Received: Oct 7, 2016
Edmonton, AB, Canada	Location:	Date Reported: Oct 20, 2016
T5S 1E5	LSD: Rainbow Valley Road	Report Number: 2141514
Attn: Barry Rakewich	P.O.: 16-442-CRV	
Sampled By: MH	Acct code: C-Release 4792006	
Company: Nichols	LINE 23	

Reference Number	1165424-7
Sample Date	Oct 07, 2016
Sample Time	NA
Sample Location	
Sample Description	SW-02
Matrix	Water

Analyte	Units	Results	Results	Results	Nominal Detection Limit
PAH - Water - Surrogate Recovery - Continued					
p-Terphenyl-d14	PAH - Surrogate	%	98		18-137

Approved by: 
 David Kapiczowski
 Senior Account Manager

Data have been validated by Analytical Quality Control and Exova's Integrated Data Validation System (IDVS).

Generation and distribution of the report, and approval by the digitized signature above, are performed through a secure and controlled automatic process.



Quality Control

Bill To: City of Edmonton	Project:	Lot ID: 1165424
Report To: Nichols Environmental (Canada)	ID: 16-442-CRV	Control Number: C0099579
17331-107 Ave NE	Name: Remediation	Date Received: Oct 7, 2016
Edmonton, AB, Canada	Location:	Date Reported: Oct 20, 2016
T5S 1E5	LSD: Rainbow Valley Road	Report Number: 2141514
Attn: Barry Rakewich	P.O.: 16-442-CRV	
Sampled By: MH	Acct code: C-Release 4792006	
Company: Nichols	LINE 23	

Extractable Petroleum Hydrocarbons - Soil

Blanks	Units	Measured	Lower Limit	Upper Limit	Passed QC
F2c C10-C16	ug/mL	0	-10	10	yes
F3c C16-C34	ug/mL	0	-30	30	yes
F4c C34-C50	ug/mL	0	-20	20	yes
F4HTGCc C34-C50+	ug/mL	0	-20	20	yes

Date Acquired: October 10, 2016

Calibration Check	Units	% Recovery	Lower Limit	Upper Limit	Passed QC
F2c C10-C16	ug/mL	103.83	85	115	yes
F3c C16-C34	ug/mL	111.70	85	115	yes
F4c C34-C50	ug/mL	109.59	85	115	yes
F4HTGCc C34-C50+	ug/mL	102.10	85	115	yes

Date Acquired: October 10, 2016

Extractable Petroleum Hydrocarbons - Water

Blanks	Units	Measured	Lower Limit	Upper Limit	Passed QC
F2 C10-C16	ug/mL	0	-0.2	0.2	yes
F3 C16-C34	ug/mL	0	-0.2	0.2	yes
F3+ C34+	ug/mL	0	-0.2	0.2	yes

Date Acquired: October 10, 2016

Calibration Check	Units	% Recovery	Lower Limit	Upper Limit	Passed QC
F2 C10-C16	ug/mL	92.06	85	115	yes
F3 C16-C34	ug/mL	102.44	85	115	yes
F3+ C34+	ug/mL	91.02	85	115	yes

Date Acquired: October 10, 2016

Mono-Aromatic Hydrocarbons - Soil

Blanks	Units	Measured	Lower Limit	Upper Limit	Passed QC
Benzene	ng	0	-0.005	0.005	yes
Toluene	ng	0	-0.06	0.06	yes
Ethylbenzene	ng	0	-0.030	0.030	yes
Total Xylenes (m,p,o)	ng	0	-0.09	0.09	yes
Styrene	ng	0	-0.030	0.030	yes

Date Acquired: October 10, 2016

Calibration Check	Units	% Recovery	Lower Limit	Upper Limit	Passed QC
Benzene	ng	106.80	85	115	yes
Toluene	ng	103.80	85	115	yes
Ethylbenzene	ng	90.40	85	115	yes
Total Xylenes (m,p,o)	ng	87.33	85	115	yes
Styrene	ng	86.20	85	115	yes

Date Acquired: October 10, 2016



Quality Control

Bill To: City of Edmonton	Project:	Lot ID: 1165424
Report To: Nichols Environmental (Canada)	ID: 16-442-CRV	Control Number: C0099579
17331-107 Ave NE	Name: Remediation	Date Received: Oct 7, 2016
Edmonton, AB, Canada	Location:	Date Reported: Oct 20, 2016
T5S 1E5	LSD: Rainbow Valley Road	Report Number: 2141514
Attn: Barry Rakewich	P.O.: 16-442-CRV	
Sampled By: MH	Acct code: C-Release 4792006	
Company: Nichols	LINE 23	

Mono-Aromatic Hydrocarbons - Soil -

Continued

Client Sample Replicates	Units	Replicate 1	Replicate 2	% RSD Criteria	Absolute Criteria	Passed QC
Benzene	mg/kg	<0.005	<0.005	50	0.010	yes
Toluene	mg/kg	<0.02	<0.02	50	0.04	yes
Ethylbenzene	mg/kg	<0.005	<0.005	50	0.020	yes
m,p-Xylene	mg/kg	<0.02	<0.02	50	0.04	yes
o-Xylene	mg/kg	<0.02	<0.02	50	0.04	yes
Total Xylenes (m,p,o)	mg/kg	<0.03	<0.03	50	0.06	yes
Styrene	mg/kg	<0.01	<0.01	50	0.020	yes

Date Acquired: October 10, 2016

Mono-Aromatic Hydrocarbons - Water

Blanks	Units	Measured	Lower Limit	Upper Limit	Passed QC
Benzene	ng	0	-0.002	0.002	yes
Toluene	ng	0	-0.0015	0.0015	yes
Ethylbenzene	ng	0	-0.0015	0.0015	yes
Total Xylenes (m,p,o)	ng	0	-0.002	0.002	yes
Styrene	ng	0	-0.002	0.002	yes

Date Acquired: October 11, 2016

Calibration Check	Units	% Recovery	Lower Limit	Upper Limit	Passed QC
Benzene	ng	86.60	85	115	yes
Toluene	ng	87.00	85	115	yes
Ethylbenzene	ng	90.20	85	115	yes
Total Xylenes (m,p,o)	ng	93.33	85	115	yes
Styrene	ng	90.80	85	115	yes

Date Acquired: October 11, 2016

Client Sample Replicates	Units	Replicate 1	Replicate 2	% RSD Criteria	Absolute Criteria	Passed QC
Benzene	mg/L	<0.001	<0.001	15	0.002	yes
Toluene	mg/L	<0.0004	<0.0004	15	0.0020	yes
Ethylbenzene	mg/L	<0.0010	<0.0010	15	0.0020	yes
Total Xylenes (m,p,o)	mg/L	<0.001	<0.001	15	0.002	yes
Styrene	mg/L	<0.001	<0.001	15	0.002	yes

Date Acquired: October 11, 2016

Matrix Spike	Units	% Recovery	Lower Limit	Upper Limit	Passed QC
Benzene	mg/L	88	85	115	yes
Toluene	mg/L	87	85	115	yes
Ethylbenzene	mg/L	86	85	115	yes
Total Xylenes (m,p,o)	mg/L	90	85	115	yes
Styrene	mg/L	94	85	115	yes

Date Acquired: October 11, 2016

PAH - Soil - Surrogate Recovery



Quality Control

Bill To: City of Edmonton	Project:	Lot ID: 1165424
Report To: Nichols Environmental (Canada)	ID: 16-442-CRV	Control Number: C0099579
17331-107 Ave NE	Name: Remediation	Date Received: Oct 7, 2016
Edmonton, AB, Canada	Location:	Date Reported: Oct 20, 2016
T5S 1E5	LSD: Rainbow Valley Road	Report Number: 2141514
Attn: Barry Rakewich	P.O.: 16-442-CRV	
Sampled By: MH	Acct code: C-Release 4792006	
Company: Nichols	LINE 23	

PAH - Soil - Surrogate Recovery

Blanks	Units	Measured	Lower Limit	Upper Limit	Passed QC
Nitrobenzene-d5	%	114.65	23	130	yes
2-Fluorobiphenyl	%	102.43	30	130	yes
p-Terphenyl-d14	%	123.29	18	137	yes
Date Acquired: October 17, 2016					

PAH - Water - Surrogate Recovery

Blanks	Units	Measured	Lower Limit	Upper Limit	Passed QC
Nitrobenzene-d5	%	108.64	23	130	yes
2-Fluorobiphenyl	%	103.39	30	130	yes
p-Terphenyl-d14	%	105.44	18	137	yes
Date Acquired: October 13, 2016					

Particle Size Analysis - Wet Sieve

Control Sample	Units	Measured	Lower Limit	Upper Limit	Passed QC
75 micron sieve	% by weight	50.3	45.6	55.8	yes
Date Acquired: October 20, 2016					

Polycyclic Aromatic Hydrocarbons - Soil

Blanks	Units	Measured	Lower Limit	Upper Limit	Passed QC
Naphthalene	ng/mL	0	-0.010	0.010	yes
Acenaphthylene	ng/mL	0	-0.05	0.05	yes
Acenaphthene	ng/mL	0	-0.05	0.05	yes
Fluorene	ng/mL	0	-0.05	0.05	yes
Phenanthrene	ng/mL	0	-0.01	0.01	yes
Anthracene	ng/mL	0	-0.003	0.003	yes
Fluoranthene	ng/mL	0	-0.01	0.01	yes
Pyrene	ng/mL	0	-0.01	0.01	yes
Benzo(a)anthracene	ng/mL	0	-0.01	0.01	yes
Chrysene	ng/mL	0	-0.05	0.05	yes
Benzo(b)fluoranthene	ng/mL	0	-0.05	0.05	yes
Benzo(b+j)fluoranthene	ng/mL	0	-0.05	0.05	yes
Benzo(k)fluoranthene	ng/mL	0	-0.05	0.05	yes
Benzo(a)pyrene	ng/mL	0	-0.05	0.05	yes
Indeno(1,2,3-c,d)pyrene	ng/mL	0	-0.05	0.05	yes
Dibenzo(a,h)anthracene	ng/mL	0	-0.05	0.05	yes
Benzo(g,h,i)perylene	ng/mL	0	-0.05	0.05	yes
Date Acquired: October 17, 2016					

Calibration Check	Units	% Recovery	Lower Limit	Upper Limit	Passed QC
Naphthalene	ng/mL	99.60	80	120	yes
Acenaphthylene	ng/mL	102.80	80	120	yes
Acenaphthene	ng/mL	95.20	80	120	yes
Fluorene	ng/mL	95.00	80	120	yes



Quality Control

Bill To: City of Edmonton	Project:	Lot ID: 1165424
Report To: Nichols Environmental (Canada)	ID: 16-442-CRV	Control Number: C0099579
17331-107 Ave NE	Name: Remediation	Date Received: Oct 7, 2016
Edmonton, AB, Canada	Location:	Date Reported: Oct 20, 2016
T5S 1E5	LSD: Rainbow Valley Road	Report Number: 2141514
Attn: Barry Rakewich	P.O.: 16-442-CRV	
Sampled By: MH	Acct code: C-Release 4792006	
Company: Nichols	LINE 23	

Polycyclic Aromatic Hydrocarbons - Soil -

Continued

Calibration Check	Units	% Recovery	Lower Limit	Upper Limit	Passed QC
Phenanthrene	ng/mL	95.00	80	120	yes
Anthracene	ng/mL	103.60	80	120	yes
Fluoranthene	ng/mL	94.60	80	120	yes
Pyrene	ng/mL	94.40	80	120	yes
Benzo(a)anthracene	ng/mL	97.80	80	120	yes
Chrysene	ng/mL	96.00	80	120	yes
Benzo(b)fluoranthene	ng/mL	99.00	80	120	yes
Benzo(k)fluoranthene	ng/mL	94.80	80	120	yes
Benzo(a)pyrene	ng/mL	97.60	80	120	yes
Indeno(1,2,3-c,d)pyrene	ng/mL	93.20	80	120	yes
Dibenzo(a,h)anthracene	ng/mL	83.40	80	120	yes
Benzo(g,h,i)perylene	ng/mL	94.40	80	120	yes

Date Acquired: October 17, 2016

Polycyclic Aromatic Hydrocarbons -

Water

Blanks	Units	Measured	Lower Limit	Upper Limit	Passed QC
Naphthalene	ng/mL	0	-0.1	0.1	yes
Quinoline	ng/mL	0	-0.1	0.1	yes
Acenaphthylene	ng/mL	0	-0.1	0.1	yes
Acenaphthene	ng/mL	0	-0.1	0.1	yes
Fluorene	ng/mL	0	-0.1	0.1	yes
Phenanthrene	ng/mL	0	-0.1	0.1	yes
Acridine	ng/mL	0	-0.1	0.1	yes
Anthracene	ng/mL	0	-0.005	0.005	yes
Fluoranthene	ng/mL	0	-0.01	0.01	yes
Pyrene	ng/mL	0	-0.01	0.01	yes
Benzo(a)anthracene	ng/mL	0	-0.01	0.01	yes
Chrysene	ng/mL	0	-0.1	0.1	yes
Benzo(b)fluoranthene	ng/mL	0	-0.1	0.1	yes
Benzo(b+j)fluoranthene	ng/mL	0	-0.1	0.1	yes
Benzo(k)fluoranthene	ng/mL	0	-0.1	0.1	yes
Benzo(a)pyrene	ng/mL	0	-0.008	0.008	yes
Indeno(1,2,3-c,d)pyrene	ng/mL	0	-0.05	0.05	yes
Dibenzo(a,h)anthracene	ng/mL	0	-0.05	0.05	yes
Benzo(g,h,i)perylene	ng/mL	0	-0.05	0.05	yes

Date Acquired: October 13, 2016

Calibration Check	Units	% Recovery	Lower Limit	Upper Limit	Passed QC
Naphthalene	ng/mL	96.60	80	120	yes
Quinoline	ng/mL	105.00	80	120	yes
Acenaphthylene	ng/mL	104.80	80	120	yes



Quality Control

Bill To: City of Edmonton	Project:	Lot ID: 1165424
Report To: Nichols Environmental (Canada)	ID: 16-442-CRV	Control Number: C0099579
17331-107 Ave NE	Name: Remediation	Date Received: Oct 7, 2016
Edmonton, AB, Canada	Location:	Date Reported: Oct 20, 2016
T5S 1E5	LSD: Rainbow Valley Road	Report Number: 2141514
Attn: Barry Rakewich	P.O.: 16-442-CRV	
Sampled By: MH	Acct code: C-Release 4792006	
Company: Nichols	LINE 23	

Polycyclic Aromatic Hydrocarbons -

Water - Continued

Calibration Check	Units	% Recovery	Lower Limit	Upper Limit	Passed QC
Acenaphthene	ng/mL	97.40	80	120	yes
Fluorene	ng/mL	101.40	80	120	yes
Phenanthrene	ng/mL	95.00	80	120	yes
Acridine	ng/mL	103.60	80	120	yes
Anthracene	ng/mL	104.00	80	120	yes
Fluoranthene	ng/mL	101.60	80	120	yes
Pyrene	ng/mL	100.80	80	120	yes
Benzo(a)anthracene	ng/mL	111.00	80	120	yes
Chrysene	ng/mL	88.60	80	120	yes
Benzo(b)fluoranthene	ng/mL	110.20	80	120	yes
Benzo(b+j)fluoranthene	ng/mL	110.00	80	120	yes
Benzo(k)fluoranthene	ng/mL	106.80	80	120	yes
Benzo(a)pyrene	ng/mL	115.00	80	120	yes
Indeno(1,2,3-c,d)pyrene	ng/mL	99.20	80	120	yes
Dibenzo(a,h)anthracene	ng/mL	96.60	80	120	yes
Benzo(g,h,i)perylene	ng/mL	90.00	80	120	yes

Date Acquired: October 13, 2016

Volatile Petroleum Hydrocarbons - Soil

Blanks	Units	Measured	Lower Limit	Upper Limit	Passed QC
F1 C6-C10	ng	0	-10	10	yes

Date Acquired: October 10, 2016

Client Sample Replicates	Units	Replicate 1	Replicate 2	% RSD Criteria	Absolute Criteria	Passed QC
F1 C6-C10	mg/kg	<10	<10	50	0	yes
F1 -BTEX	mg/kg	<10	<10	50	0	yes

Date Acquired: October 10, 2016

Matrix Spike	Units	% Recovery	Lower Limit	Upper Limit	Passed QC
F1 C6-C10	mg/kg	93	80	120	yes

Date Acquired: October 10, 2016

Volatile Petroleum Hydrocarbons - Water

Blanks	Units	Measured	Lower Limit	Upper Limit	Passed QC
F1 -BTEX	ng	0	-0.3	0.3	yes
F1 C6-C10	ng	0	-0.300	0.300	yes
F2 C10-C16	ng	0	-0.3	0.3	yes

Date Acquired: October 11, 2016

Calibration Check	Units	% Recovery	Lower Limit	Upper Limit	Passed QC
F2 C10-C16	ng	117.00	80	120	yes

Date Acquired: October 11, 2016

Client Sample Replicates	Units	Replicate 1	Replicate 2	% RSD Criteria	Absolute Criteria	Passed QC
--------------------------	-------	-------------	-------------	----------------	-------------------	-----------



Quality Control

Bill To: City of Edmonton	Project:	Lot ID: 1165424
Report To: Nichols Environmental (Canada)	ID: 16-442-CRV	Control Number: C0099579
17331-107 Ave NE	Name: Remediation	Date Received: Oct 7, 2016
Edmonton, AB, Canada	Location:	Date Reported: Oct 20, 2016
T5S 1E5	LSD: Rainbow Valley Road	Report Number: 2141514
Attn: Barry Rakewich	P.O.: 16-442-CRV	
Sampled By: MH	Acct code: C-Release 4792006	
Company: Nichols	LINE 23	

Volatile Petroleum Hydrocarbons - Water

- Continued

Client Sample	Replicates	Units	Replicate 1	Replicate 2	% RSD Criteria	Absolute Criteria	Passed QC
F1	C6-C10	mg/L	<0.1	<0.1	50		yes
F2	C10-C16	mg/L	<0.1	<0.1	50		yes

Date Acquired: October 11, 2016



Methodology and Notes

Bill To: City of Edmonton	Project:	Lot ID: 1165424
Report To: Nichols Environmental (Canada)	ID: 16-442-CRV	Control Number: C0099579
17331-107 Ave NE	Name: Remediation	Date Received: Oct 7, 2016
Edmonton, AB, Canada	Location:	Date Reported: Oct 20, 2016
T5S 1E5	LSD: Rainbow Valley Road	Report Number: 2141514
Attn: Barry Rakewich	P.O.: 16-442-CRV	
Sampled By: MH	Acct code: C-Release 4792006	
Company: Nichols	LINE 23	

Method of Analysis

Method Name	Reference	Method	Date Analysis Started	Location
BTEX-CCME - Soil	CCME	* Reference Method for Canada-Wide Standard for PHC in Soil, CWS PHCS TIER 1	10-Oct-16	Exova Calgary
BTEX-CCME - Soil	US EPA	* Volatile Organic Compounds in Various Sample Matrices Using Equilibrium Headspace Analysis/Gas Chromatography Mass Spectrometry, 5021/8260	10-Oct-16	Exova Calgary
BTEX-CCME - Water	US EPA	* Volatile Organic Compounds in Various Sample Matrices Using Equilibrium Headspace Analysis/Gas Chromatography Mass Spectrometry, 5021/8260	11-Oct-16	Exova Calgary
PAH - Soil	AESRD	Index of Additive Cancer Risk (IACR), PAHs	17-Oct-16	Exova Calgary
PAH - Soil	US EPA	* Semivolatile Organic Compounds by Gas Chromatography/Mass Spectrometry, 8270	17-Oct-16	Exova Calgary
PAH - Water	AESRD	Carcinogenic PAHs Toxic Potency Equivalence (as B(a)P TPE), PAHw	13-Oct-16	Exova Calgary
PAH - Water	US EPA	* Semivolatile Organic Compounds by Gas Chromatography/Mass Spectrometry, 8270	13-Oct-16	Exova Calgary
Particle Size by Wet Sieve	Carter	* Procedure for Particle Size Separation, 55.2.3	20-Oct-16	Exova Edmonton
TEH-CCME - Water	EPA/CCME	* Separatory Funnel Liquid-liquid Extraction/CCME, EPA 3510/CCME	10-Oct-16	Exova Calgary
TEH-CCME-Soil (Shake)	CCME	* Reference Method for Canada-Wide Standard for PHC in Soil, CWS PHCS TIER 1	10-Oct-16	Exova Calgary

* Reference Method Modified

References

AESRD	Alberta Tier 1 Soil and Groundwater Remediation Guidelines
ASTM	Annual Book of ASTM Standards
Carter	Soil Sampling and Methods of Analysis.
CCME	Canadian Council of Ministers of the Environment
EPA/CCME	Environmental Protection Agency Test Methods - US/CCME
US EPA	US Environmental Protection Agency Test Methods

Comments:

Methodology and Notes

Bill To: City of Edmonton	Project:	Lot ID: 1165424
Report To: Nichols Environmental (Canada)	ID: 16-442-CRV	Control Number: C0099579
17331-107 Ave NE	Name: Remediation	Date Received: Oct 7, 2016
Edmonton, AB, Canada	Location:	Date Reported: Oct 20, 2016
T5S 1E5	LSD: Rainbow Valley Road	Report Number: 2141514
Attn: Barry Rakewich	P.O.: 16-442-CRV	
Sampled By: MH	Acct code: C-Release 4792006	
Company: Nichols	LINE 23	

-
- Report was issued to include addition of PAH analysis on samples 1-5 requested by Michael Harquail of Nichols Environmental on Oct.18, 2016. Previous report #2138544.

Please direct any inquiries regarding this report to our Client Services group.

Results relate only to samples as submitted.

The test report shall not be reproduced except in full, without the written approval of the laboratory.

Analytical Report

Bill To: City of Edmonton	Project:	Lot ID: 1165424
Report To: Nichols Environmental (Canada)	ID: 16-442-CRV	Control Number: C0099579
17331-107 Ave NE	Name: Remediation	Date Received: Oct 7, 2016
Edmonton, AB, Canada	Location:	Date Reported: Oct 20, 2016
T5S 1E5	LSD: Rainbow Valley Road	Report Number: 2141514
Attn: Barry Rakewich	P.O.: 16-442-CRV	
Sampled By: MH	Acct code: C-Release 4792006	
Company: Nichols	LINE 23	

Petroleum Hydrocarbons in Soil

Batch Notes

1. The method used complies with the Reference Method for the Canada Wide Standards for Petroleum Hydrocarbons in Soil - Tier 1, April 2001, including Addendum 1, and is accredited for use in Exova.
2. Modifications of the method: See Notes and Methodology for nonconformances (if applicable).
3. Qualifications on results: See Notes and Methodology for nonconformances (if applicable).
4. Silica gel treatment is performed for fractions F2, F3, F4.
5. F1-BTEX: BTEX has been subtracted from the F1 fraction.
6. If analyzed, naphthalene has been subtracted from fraction F2 and selected PAHs have been subtracted from fraction F3.
7. F4HTGC is reported when more than 5% of the total carbon envelope elutes past C₅₀.
8. Exova does not routinely report Gravimetric Heavy Hydrocarbons (F4G or F4G-sg), F4HTGC through extended range high temperature GC is reported instead.
9. When both F4(C₃₄-C₅₀) and F4HTGC are reported, F4HTGC is the final F4 that is to be used for interpreting the CWS.
10. Quality criteria met for the batch: Data is reported in Quality Control Section of report (if requested).
 - nC₆ and nC₁₀ response factors (RF) are within 30% of RF for toluene
 - nC₁₀, nC₁₆ and nC₃₄ RFs are within 10% of each other
 - nC₅₀ RF is within 30% of the average RF for nC₁₀+nC₁₆+nC₃₄
 - linearity is within 15% for each of the calibrated carbon ranges
11. Batch data for analytical quality control are available on request.
12. Extraction and analysis holding times were met: See Notes and Methodology for nonconformances (if applicable).

Approved by:



David Kapiczowski
Senior Account Manager

Data have been validated by Analytical Quality Control and Exova's Integrated Data Validation System (IDVS).

Generation and distribution of the report, and approval by the digitized signature above, are performed through a secure and controlled automatic process.

Hydrocarbon Chromatogram

Bill To: Nichols Environmental (Canada)	Project ID: 16-442-CRV	Lot ID: 1165424
Report To: Nichols Environmental (Canada)	Name: Remediation	Control Number: C0099579
17331-107 Ave NE	Location: Rainbow Valley Road	Date Received: Oct 7, 2016
Edmonton, AB, Canada	LSD: {Project ID}	Date Reported: Oct 13, 2016
T5S 1E5	P.O.: {Project ID}	Report Number: 2138544
Attn: Barry Rakewich		
Sampled by: MH		
Company: Nichols		

Exova Number: 1165424-7 Sample Description: SW-02
 Sample Date: Oct 7, 2016

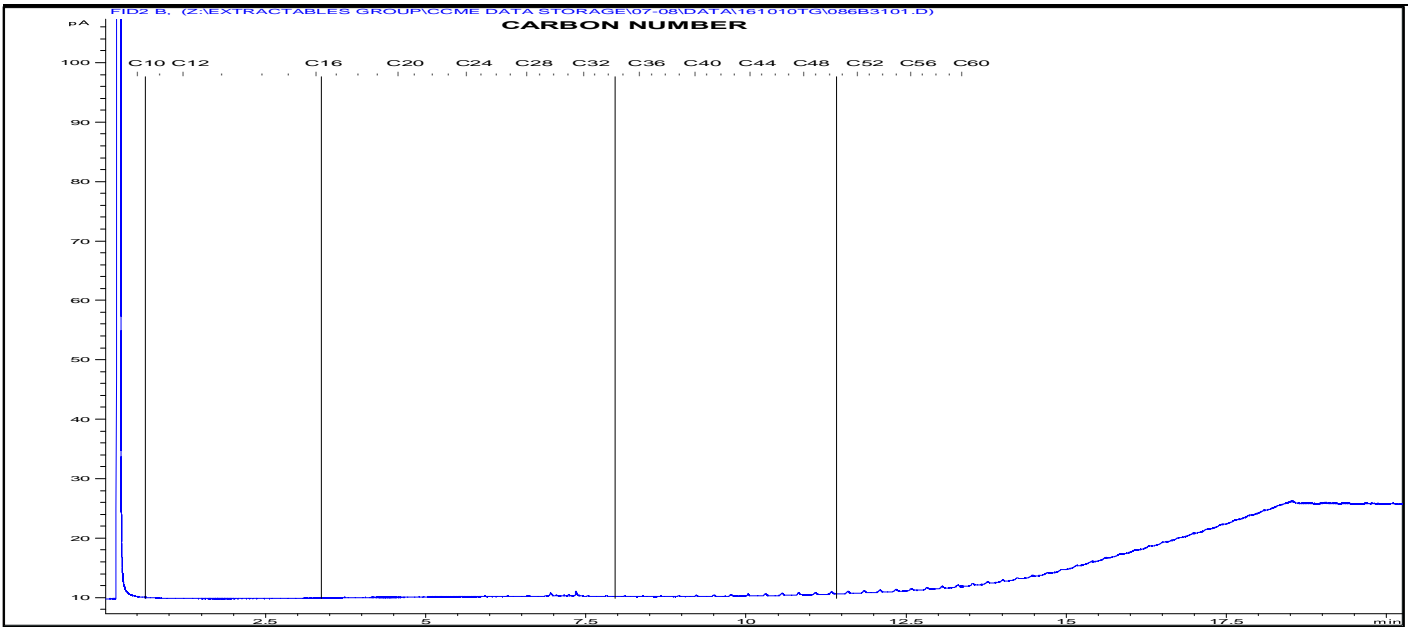

TYPICAL PRODUCT CHROMATOGRAMS

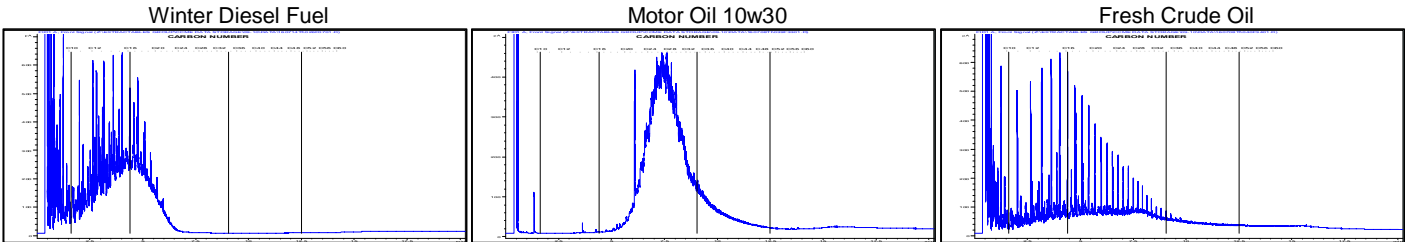

Product Carbon Number Ranges

Gasoline	C4-C12	Kerosene	C7-C16	Lubricating Oils	C20-C40
Varsol	C8-C12	Diesel	C8-C22	Crude Oils	C3-C60+



Hydrocarbon Chromatogram

Bill To: Nichols Environmental (Canada)	Project ID: 16-442-CRV	Lot ID: 1165424
Report To: Nichols Environmental (Canada)	Name: Remediation	Control Number: C0099579
17331-107 Ave NE	Location:	Date Received: Oct 7, 2016
Edmonton, AB, Canada	LSD: Rainbow Valley Road	Date Reported: Oct 13, 2016
T5S 1E5	P.O.: {Project ID}	Report Number: 2138544
Attn: Barry Rakewich		
Sampled by: MH		
Company: Nichols		

Exova Number: 1165424-1 Sample Description: 0.05 SA-01 Silica Gel Treated
 Sample Date: Oct 7, 2016 m

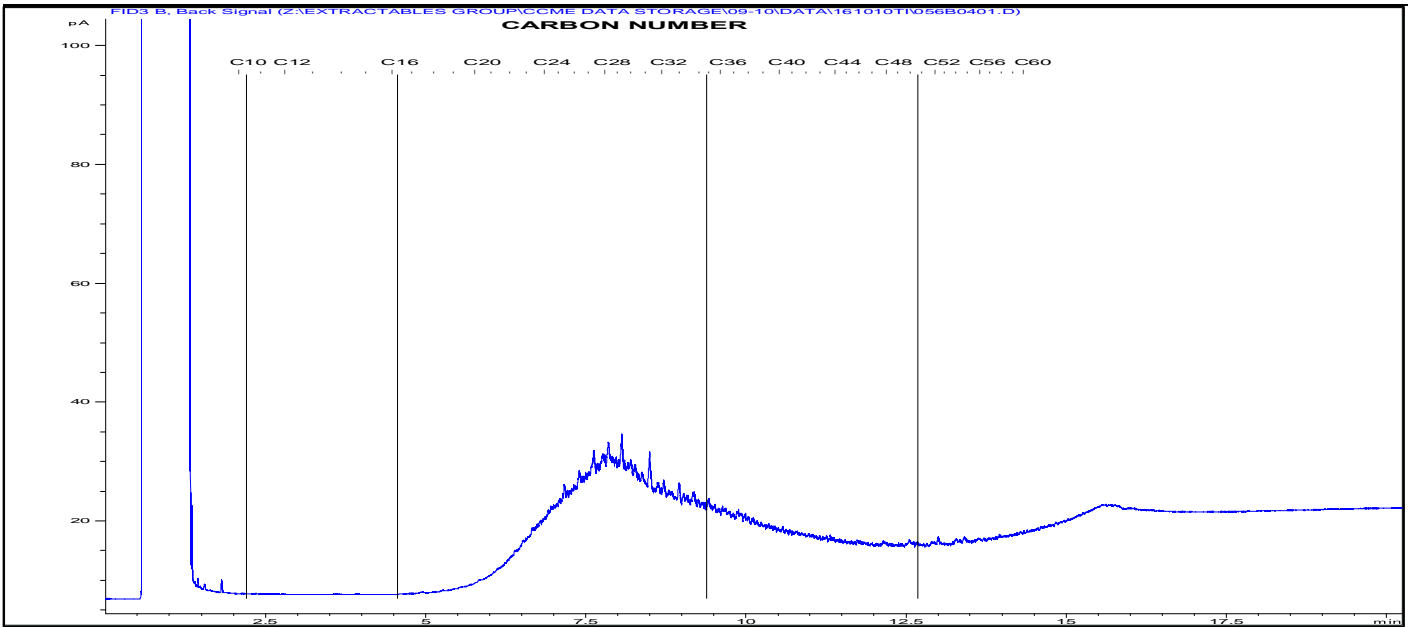

TYPICAL PRODUCT CHROMATOGRAMS

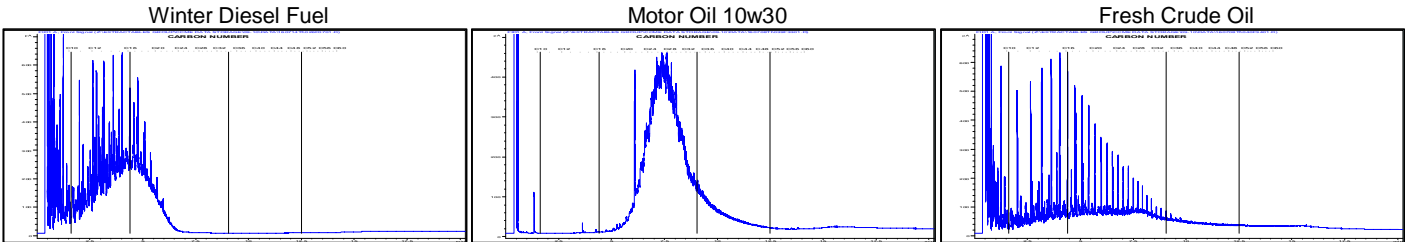

Product Carbon Number Ranges

Gasoline	C4-C12	Kerosene	C7-C16	Lubricating Oils	C20-C40
Varsol	C8-C12	Diesel	C8-C22	Crude Oils	C3-C60+

Hydrocarbon Chromatogram

Bill To: Nichols Environmental (Canada)	Project ID: 16-442-CRV	Lot ID: 1165424
Report To: Nichols Environmental (Canada)	Name: Remediation	Control Number: C0099579
17331-107 Ave NE	Location:	Date Received: Oct 7, 2016
Edmonton, AB, Canada	LSD: Rainbow Valley Road	Date Reported: Oct 13, 2016
T5S 1E5	P.O.: {Project ID}	Report Number: 2138544
Attn: Barry Rakewich		
Sampled by: MH		
Company: Nichols		

Exova Number: 1165424-2
 Sample Date: Oct 7, 2016

Sample Description: 0.05 SA-12
 m

Silica Gel Treated

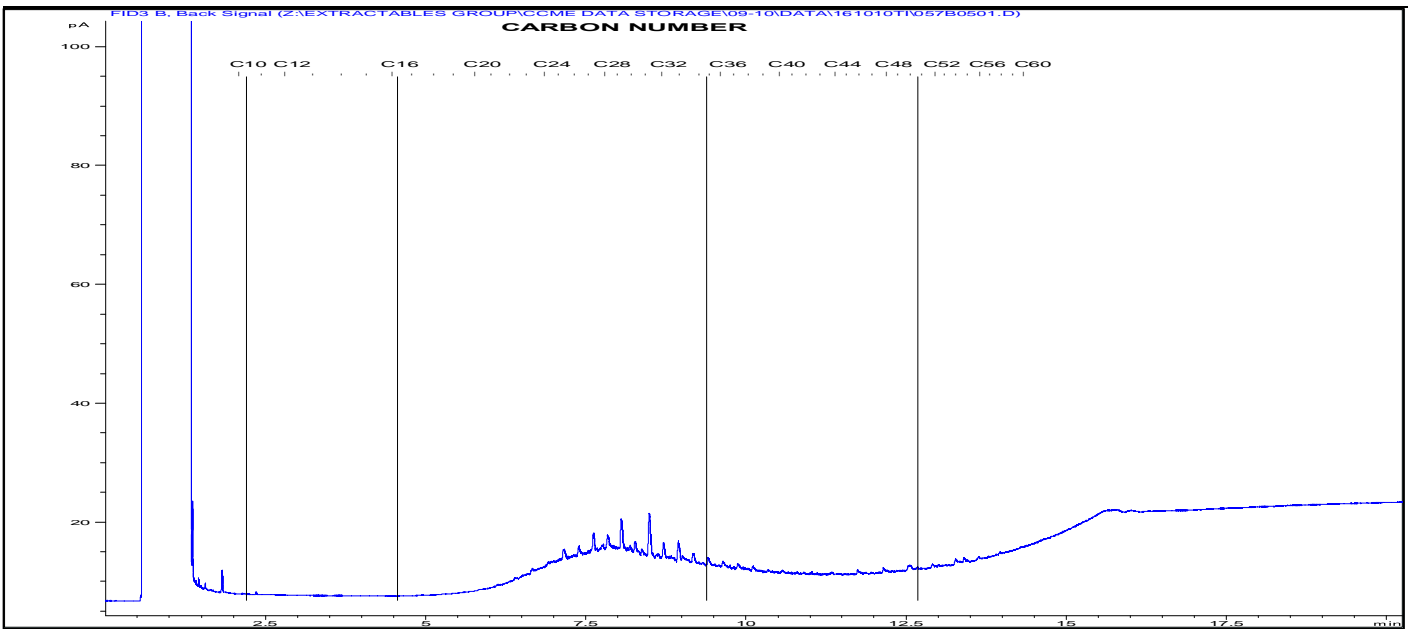

TYPICAL PRODUCT CHROMATOGRAMS

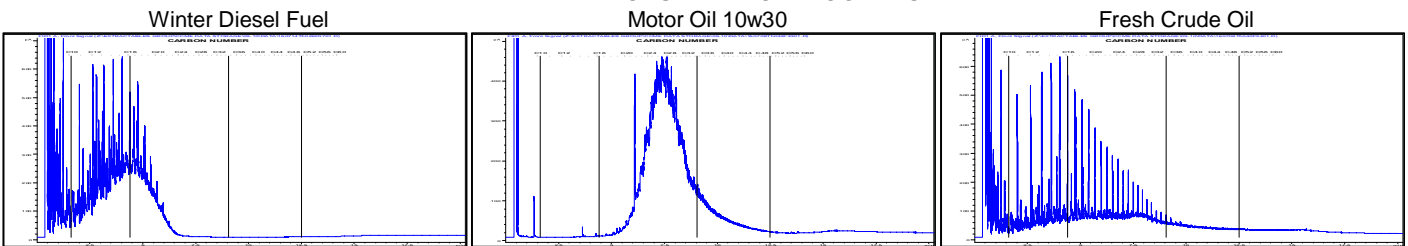

Product Carbon Number Ranges

Gasoline	C4-C12	Kerosene	C7-C16	Lubricating Oils	C20-C40
Varsol	C8-C12	Diesel	C8-C22	Crude Oils	C3-C60+



Hydrocarbon Chromatogram

Bill To: Nichols Environmental (Canada)	Project ID: 16-442-CRV	Lot ID: 1165424
Report To: Nichols Environmental (Canada)	Name: Remediation	Control Number: C0099579
17331-107 Ave NE	Location:	Date Received: Oct 7, 2016
Edmonton, AB, Canada	LSD: Rainbow Valley Road	Date Reported: Oct 13, 2016
T5S 1E5	P.O.: {Project ID}	Report Number: 2138544
Attn: Barry Rakewich		
Sampled by: MH		
Company: Nichols		

Exova Number: 1165424-3 Sample Description: 1.8 SA-18 Silica Gel Treated
 Sample Date: Oct 7, 2016 m

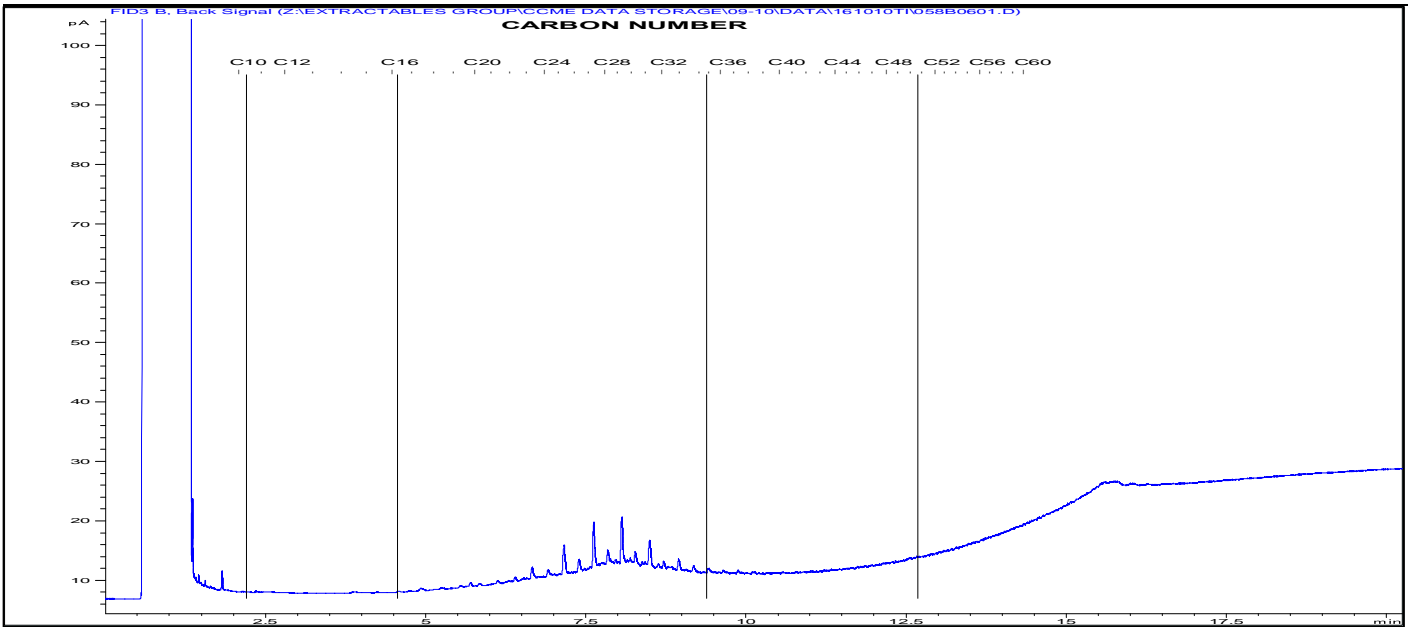

TYPICAL PRODUCT CHROMATOGRAMS

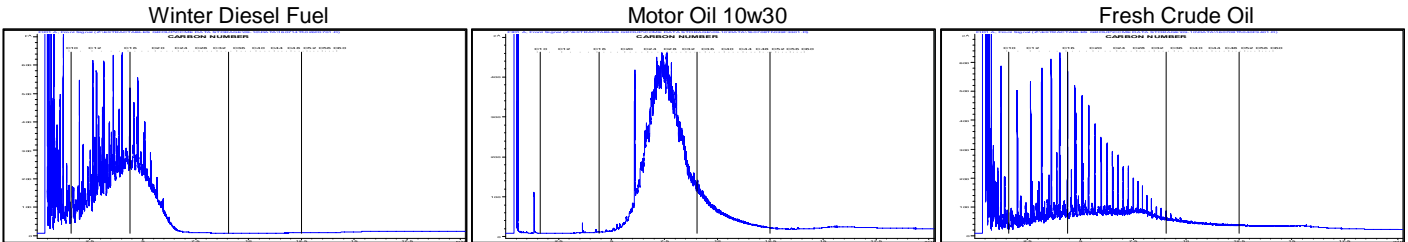

Product Carbon Number Ranges

Gasoline	C4-C12	Kerosene	C7-C16	Lubricating Oils	C20-C40
Varsol	C8-C12	Diesel	C8-C22	Crude Oils	C3-C60+

Hydrocarbon Chromatogram

Bill To: Nichols Environmental (Canada)	Project ID: 16-442-CRV	Lot ID: 1165424
Report To: Nichols Environmental (Canada)	Name: Remediation	Control Number: C0099579
17331-107 Ave NE	Location:	Date Received: Oct 7, 2016
Edmonton, AB, Canada	LSD: Rainbow Valley Road	Date Reported: Oct 13, 2016
T5S 1E5	P.O.: {Project ID}	Report Number: 2138544
Attn: Barry Rakewich		
Sampled by: MH		
Company: Nichols		

Exova Number: 1165424-4
 Sample Date: Oct 7, 2016

Sample Description: 1.0 SA-22
 m

Silica Gel Treated

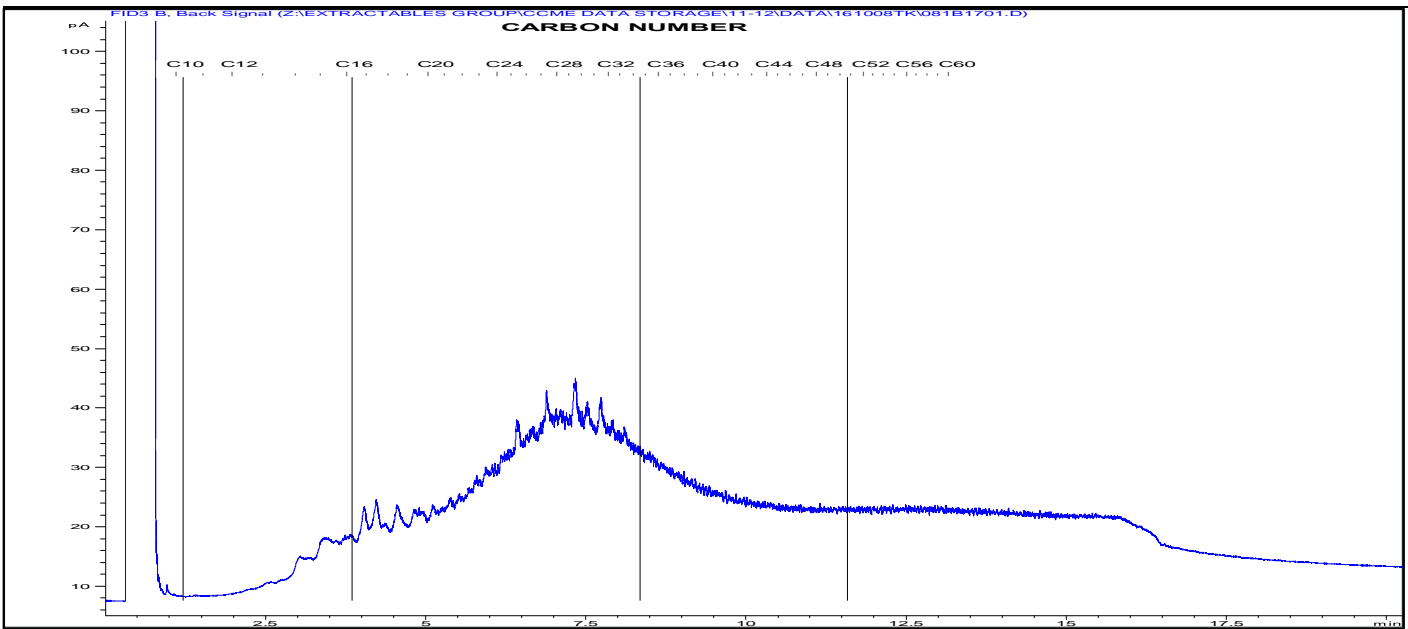

TYPICAL PRODUCT CHROMATOGRAMS

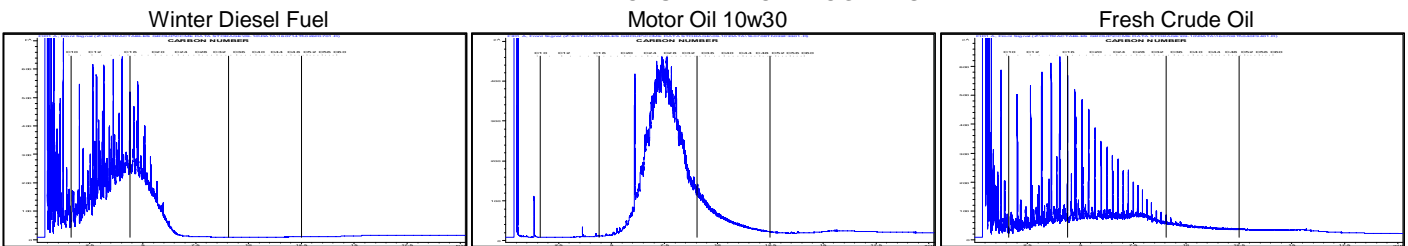

Product Carbon Number Ranges

Gasoline	C4-C12	Kerosene	C7-C16	Lubricating Oils	C20-C40
Varsol	C8-C12	Diesel	C8-C22	Crude Oils	C3-C60+

Hydrocarbon Chromatogram

Bill To: Nichols Environmental (Canada)	Project ID: 16-442-CRV	Lot ID: 1165424
Report To: Nichols Environmental (Canada)	Name: Remediation	Control Number: C0099579
17331-107 Ave NE	Location:	Date Received: Oct 7, 2016
Edmonton, AB, Canada	LSD: Rainbow Valley Road	Date Reported: Oct 13, 2016
T5S 1E5	P.O.: {Project ID}	Report Number: 2138544
Attn: Barry Rakewich		
Sampled by: MH		
Company: Nichols		

Exova Number: 1165424-5 Sample Description: 0.15 SA-23 Silica Gel Treated
 Sample Date: Oct 7, 2016 m

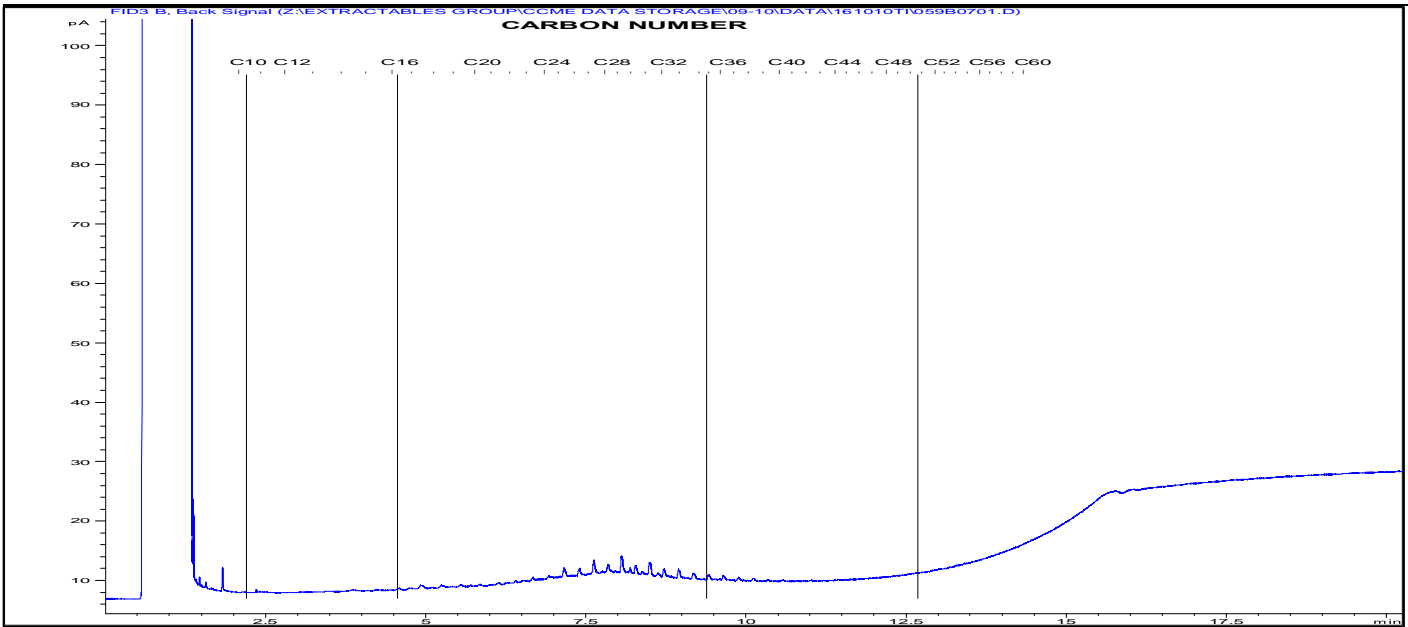

TYPICAL PRODUCT CHROMATOGRAMS

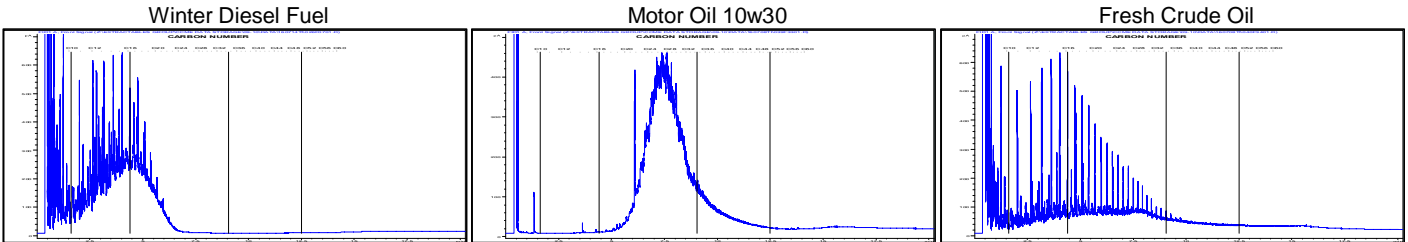

Product Carbon Number Ranges

Gasoline	C4-C12	Kerosene	C7-C16	Lubricating Oils	C20-C40
Varsol	C8-C12	Diesel	C8-C22	Crude Oils	C3-C60+

Hydrocarbon Chromatogram

Bill To: Nichols Environmental (Canada)	Project ID: 16-442-CRV	Lot ID: 1165424
Report To: Nichols Environmental (Canada)	Name: Remediation	Control Number: C0099579
17331-107 Ave NE	Location:	Date Received: Oct 7, 2016
Edmonton, AB, Canada	LSD: Rainbow Valley Road	Date Reported: Oct 13, 2016
T5S 1E5	P.O.: {Project ID}	Report Number: 2138544
Attn: Barry Rakewich		
Sampled by: MH		
Company: Nichols		

Exova Number: 1165424-6
 Sample Date: Oct 7, 2016

Sample Description: 0.05 SA-27
 m

Silica Gel Treated

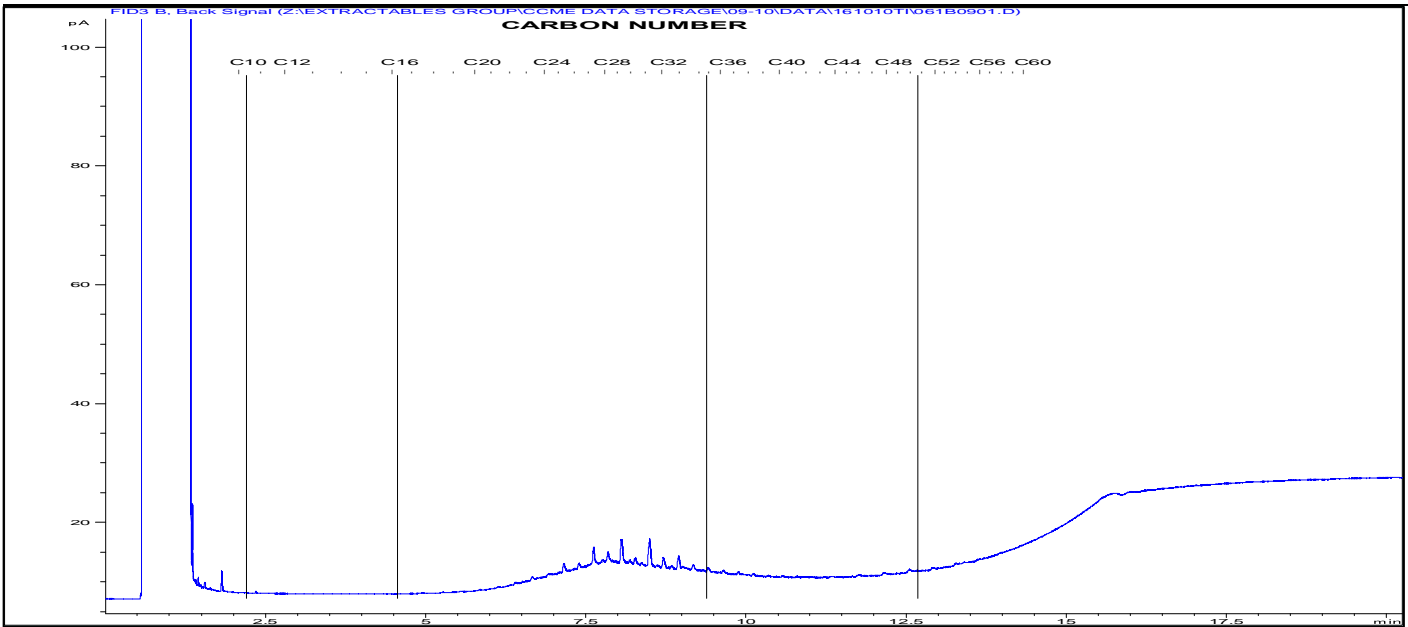

TYPICAL PRODUCT CHROMATOGRAMS

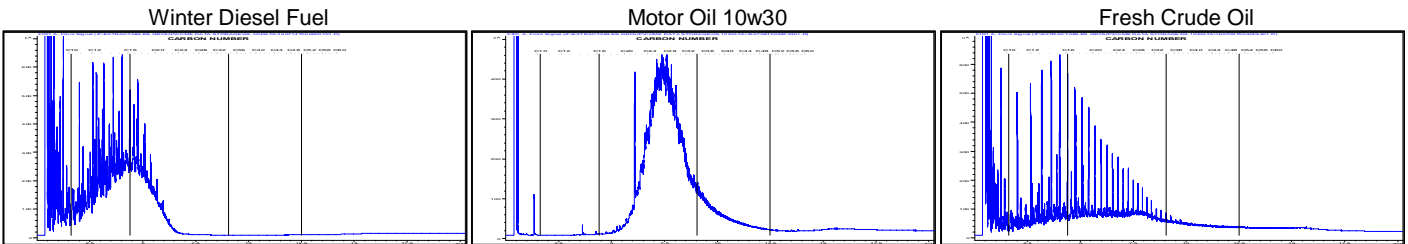

Product Carbon Number Ranges

Gasoline	C4-C12	Kerosene	C7-C16	Lubricating Oils	C20-C40
Varsol	C8-C12	Diesel	C8-C22	Crude Oils	C3-C60+

Invoice to:		Report To:		Report Results	Regulatory Requirement
Company: <i>Nichols Env.</i>	Address:	Company:	Address:	E-Mail <input checked="" type="checkbox"/>	HCDWQG <input checked="" type="checkbox"/>
Attention: <i>Mike H / Barry P</i>	Phone: <i>280 318 2063</i>	Attention:	Phone:	Mail <input type="checkbox"/>	Ab Tier 1 <input checked="" type="checkbox"/>
Cell:	Fax:	Cell:	Fax:	Online <input type="checkbox"/>	SPIGEC <input type="checkbox"/>
E-mail:	Agreement ID:	E-mail 1:	E-mail 2:	Fax <input type="checkbox"/>	BCCSR <input type="checkbox"/>
Copy of report:	Copy of invoice:	Copy of invoice:		PDF <input checked="" type="checkbox"/>	Other (list below)
				Excel <input checked="" type="checkbox"/>	
				QA/QC <input checked="" type="checkbox"/>	

RUSH Priority

Emergency (contact lab for turnaround and pricing)	When "ASAP" is requested, turn around will default to a 100% RUSH priority, with pricing and turn around time to match. Please contact the lab prior to submitting RUSH samples. If not all samples require RUSH, please indicate in the special instructions.
Priority 1-2 working days (100% surcharge)	
Urgent 2-3 working days (50% surcharge)	

Date Required: _____ Signature: _____

Special Instructions/Comments (please include contact information including ph. # if different from above).

Number of Containers

1	2	3	4	5	6	7	8	9	10	11	12	13	14	15

*15 EX HCDWQG-14
15 EX BCCSR-15
P.A.H.*

Sample Custody (please print)

Sampled by: *MAW*

Company: *NIEL*

This section for Lab use only

Date/Time stamp:
OCT 7 PM 5:47

Site I.D.	Sample Description	Depth start in cm (m)	Depth end in cm (m)	Date/Time Sampled	Matrix	Sampling Method	Enter tests above (✓ relevant samples below)	Indicate in the space allotted any deficiencies by the corresponding number.
1	<i>SA-01</i>		<i>0.25</i>	<i>01/27/16</i>	<i>soil</i>	<i>grab</i>	<i>1</i>	1. Indicate any samples that were not packaged well
2	<i>SA-12</i>		<i>0.25</i>				<i>1</i>	2. Indicate any samples not received in Exova supplies
3	<i>SA-18</i>		<i>1.0</i>				<i>1</i>	3. Indicate any samples that were not clearly labeled
4	<i>SA-22</i>		<i>1.0</i>				<i>1</i>	4. Indicate any samples not received within the required hold time or temp.
5	<i>SA-23</i>		<i>0.75</i>				<i>1</i>	5. Indicate any missing or extra samples
6	<i>SA-27</i>		<i>0.25</i>				<i>1</i>	6. Indicate any samples that were received broken
7	<i>Soil-02</i>				<i>water</i>		<i>5</i>	7. Indicate any samples where sufficient volume was not received
8								8. Indicate any samples received in an inappropriate container
9								
10								
11								
12								
13								
14								
15								

Submission of this form acknowledges acceptance of Exova's Standard Terms and Conditions (<http://www.exova.com/about/terms-and-conditions/>)

Please indicate any potentially hazardous samples

Page _____ of _____ Control # **C 0099579**

Indicate Lot: **1165424** COC



Shipping: COD Y/ N

and size of coolers

emp. received: *4.7* Delivery Method: *Hand*

received by: *W* Waybill:

ED 120-02

Report Transmission Cover Page

Bill To: Nichols Environmental (Canada)	Project:	Lot ID: 1167994
Report To: Nichols Environmental (Canada)	ID: 16-442-CRY	Control Number:
17331-107 Ave NE	Name: Remediation	Date Received: Oct 21, 2016
Edmonton, AB, Canada	Location: Snow Valley Edmonton	Date Reported: Oct 29, 2016
T5S 1E5	LSD:	Report Number: 2142375
Attn: Michael Harquail	P.O.: 16-442-CRY	
Sampled By: MAN	Acct code:	
Company: NECL		

Contact & Affiliation	Address	Delivery Commitments
Accounts Payable Nichols Environmental (Canada) Ltd	17331-107 Ave Edmonton, Alberta T5S 1E5 Phone: (780) 484-3377 Fax: (780) 484-5093 Email: ap@nicholsenvironmental.com	On [Lot Approval and Final Test Report Approval] send (Invoice) by Email - Single Report
Barry Rakewich Nichols Environmental (Canada) Ltd	17331-107 Ave NE Edmonton, Alberta T5S 1E5 Phone: (780) 484-3377 Fax: (780) 484-5093 Email: rakewich@nicholsenvironmental.com	On [Report Approval] send (Test Report) by Email - Single Report On [Report Approval] send (Test Report, COC) by Email - Merge Reports
Michael Harquail Nichols Environmental (Canada) Ltd	17331-107 Ave NE Edmonton, Alberta T5S 1E5 Phone: (780) 484-3377 Fax: (780) 484-5093 Email: Harquail@nicholsenvironmental.com	On [Lot Verification] send (COA, COC) by Email - Merge Reports On [Report Approval] send (Test Report) by Email - Single Report On [Report Approval] send (COC, Test Report) by Email - Merge Reports

Notes To Clients:

The information contained on this and all other pages transmitted, is intended for the addressee only and is considered confidential. If the reader is not the intended recipient, you are hereby notified that any use, dissemination, distribution or copy of this transmission is strictly prohibited. If you receive this transmission by error, or if this transmission is not satisfactory, please notify us by telephone.



Analytical Report

Bill To: Nichols Environmental (Canada) Project:
Report To: Nichols Environmental (Canada) ID: 16-442-CRY
17331-107 Ave NE Name: Remediation
Edmonton, AB, Canada Location: Snow Valley Edmonton
T5S 1E5 LSD:
Attn: Michael Harquail P.O.: 16-442-CRY
Sampled By: MAN Acct code:
Company: NECL

Lot ID: **1167994**
Control Number:
Date Received: Oct 21, 2016
Date Reported: Oct 29, 2016
Report Number: 2142375

	Reference Number	1167994-1	1167994-2	1167994-3		
	Sample Date	Oct 21, 2016	Oct 21, 2016	Oct 21, 2016		
	Sample Time	NA	NA	NA		
	Sample Location					
	Sample Description	SA-33 / 0.15 / m	SA-34 / 0.05 / m	SA-35 / 0.15 / m		
	Matrix	Soil	Soil	Soil		
Analyte	Units	Results	Results	Results	Nominal Detection Limit	
Polycyclic Aromatic Hydrocarbons - Soil						
Naphthalene	Dry Weight	mg/kg	<0.010	<0.010	<0.010	0.010
Acenaphthylene	Dry Weight	mg/kg	<0.05	<0.05	<0.05	0.05
Acenaphthene	Dry Weight	mg/kg	<0.05	<0.05	<0.05	0.05
Fluorene	Dry Weight	mg/kg	<0.05	<0.05	<0.05	0.05
Phenanthrene	Dry Weight	mg/kg	<0.01	<0.01	<0.01	0.01
Anthracene	Dry Weight	mg/kg	<0.003	<0.003	<0.003	0.003
Fluoranthene	Dry Weight	mg/kg	<0.01	<0.01	<0.01	0.01
Pyrene	Dry Weight	mg/kg	<0.01	<0.01	<0.01	0.01
Benzo(a)anthracene	Dry Weight	mg/kg	<0.01	<0.01	<0.01	0.01
Chrysene	Dry Weight	mg/kg	<0.05	<0.05	<0.05	0.05
Benzo(b+j)fluoranthene	Dry Weight	mg/kg	<0.05	<0.05	<0.05	0.05
Benzo(k)fluoranthene	Dry Weight	mg/kg	<0.05	<0.05	<0.05	0.05
Benzo(a)pyrene	Dry Weight	mg/kg	<0.05	<0.05	<0.05	0.05
Indeno(1,2,3-c,d)pyrene	Dry Weight	mg/kg	<0.05	<0.05	<0.05	0.05
Dibenzo(a,h)anthracene	Dry Weight	mg/kg	<0.05	<0.05	<0.05	0.05
Benzo(g,h,i)perylene	Dry Weight	mg/kg	<0.05	<0.05	<0.05	0.05
IACR_Coarse	Index of Additive Cancer Risk		<0.001	<0.001	<0.001	0.001
IACR_Fine	Index of Additive Cancer Risk		<0.001	0.001	<0.001	0.001
PAH - Soil - Surrogate Recovery						
Nitrobenzene-d5	PAH - Surrogate	%	98	95	99	23-130
2-Fluorobiphenyl	PAH - Surrogate	%	101	87	104	30-130
p-Terphenyl-d14	PAH - Surrogate	%	103	95	114	18-137



Analytical Report

Bill To: Nichols Environmental (Canada) Project:
Report To: Nichols Environmental (Canada) ID: 16-442-CRY
17331-107 Ave NE Name: Remediation
Edmonton, AB, Canada Location: Snow Valley Edmonton
T5S 1E5 LSD:
Attn: Michael Harquail P.O.: 16-442-CRY
Sampled By: MAN Acct code:
Company: NECL

Lot ID: **1167994**
Control Number:
Date Received: Oct 21, 2016
Date Reported: Oct 29, 2016
Report Number: 2142375

Reference Number 1167994-4
Sample Date Oct 21, 2016
Sample Time NA
Sample Location
Sample Description SA-36 / 0.8 / m
Matrix Soil

Analyte	Units	Results	Results	Results	Nominal Detection Limit
Polycyclic Aromatic Hydrocarbons - Soil					
Naphthalene	Dry Weight	mg/kg	<0.010		0.010
Acenaphthylene	Dry Weight	mg/kg	<0.05		0.05
Acenaphthene	Dry Weight	mg/kg	<0.05		0.05
Fluorene	Dry Weight	mg/kg	<0.05		0.05
Phenanthrene	Dry Weight	mg/kg	<0.01		0.01
Anthracene	Dry Weight	mg/kg	<0.003		0.003
Fluoranthene	Dry Weight	mg/kg	<0.01		0.01
Pyrene	Dry Weight	mg/kg	<0.01		0.01
Benzo(a)anthracene	Dry Weight	mg/kg	<0.01		0.01
Chrysene	Dry Weight	mg/kg	<0.05		0.05
Benzo(b+j)fluoranthene	Dry Weight	mg/kg	<0.05		0.05
Benzo(k)fluoranthene	Dry Weight	mg/kg	<0.05		0.05
Benzo(a)pyrene	Dry Weight	mg/kg	<0.05		0.05
Indeno(1,2,3-c,d)pyrene	Dry Weight	mg/kg	<0.05		0.05
Dibenzo(a,h)anthracene	Dry Weight	mg/kg	<0.05		0.05
Benzo(g,h,i)perylene	Dry Weight	mg/kg	<0.05		0.05
IACR_Coarse	Index of Additive Cancer Risk		<0.001		0.001
IACR_Fine	Index of Additive Cancer Risk		<0.001		0.001
PAH - Soil - Surrogate Recovery					
Nitrobenzene-d5	PAH - Surrogate	%	90		23-130
2-Fluorobiphenyl	PAH - Surrogate	%	91		30-130
p-Terphenyl-d14	PAH - Surrogate	%	97		18-137



Analytical Report

Bill To: Nichols Environmental (Canada) Project:
Report To: Nichols Environmental (Canada) ID: 16-442-CRY
17331-107 Ave NE Name: Remediation
Edmonton, AB, Canada Location: Snow Valley Edmonton
T5S 1E5 LSD:
Attn: Michael Harquail P.O.: 16-442-CRY
Sampled By: MAN Acct code:
Company: NECL

Lot ID: **1167994**
Control Number:
Date Received: Oct 21, 2016
Date Reported: Oct 29, 2016
Report Number: 2142375

Reference Number 1167994-5
Sample Date Oct 21, 2016
Sample Time NA
Sample Location
Sample Description BF-01
Matrix Soil

Analyte	Units	Results	Results	Results	Nominal Detection Limit
Metals Strong Acid Digestion					
Boron	Saturated Paste	mg/L	0.13		0.05
Antimony	Strong Acid Extractable	mg/kg	0.3		0.2
Arsenic	Strong Acid Extractable	mg/kg	8.3		0.2
Barium	Strong Acid Extractable	mg/kg	188		1
Beryllium	Strong Acid Extractable	mg/kg	0.7		0.1
Cadmium	Strong Acid Extractable	mg/kg	0.23		0.01
Chromium	Strong Acid Extractable	mg/kg	18.9		0.5
Cobalt	Strong Acid Extractable	mg/kg	9.3		0.1
Copper	Strong Acid Extractable	mg/kg	17.5		1
Lead	Strong Acid Extractable	mg/kg	9.4		0.1
Mercury	Strong Acid Extractable	mg/kg	<0.05		0.05
Molybdenum	Strong Acid Extractable	mg/kg	<1.0		1
Nickel	Strong Acid Extractable	mg/kg	24.7		0.5
Selenium	Strong Acid Extractable	mg/kg	0.7		0.3
Silver	Strong Acid Extractable	mg/kg	0.1		0.1
Thallium	Strong Acid Extractable	mg/kg	0.13		0.05
Tin	Strong Acid Extractable	mg/kg	<1.0		1
Uranium	Strong Acid Extractable	mg/kg	2.1		0.5
Vanadium	Strong Acid Extractable	mg/kg	28.8		0.1
Zinc	Strong Acid Extractable	mg/kg	72		1
Salinity					
Electrical Conductivity	Saturated Paste	dS/m	0.82		0.01
SAR	Saturated Paste		0.3		
% Saturation		%	67		
Calcium	Saturated Paste	mg/kg	75.7		
Magnesium	Saturated Paste	mg/kg	17.6		
Sodium	Saturated Paste	mg/kg	10		
Potassium	Saturated Paste	mg/kg	2		
Chloride	Saturated Paste	mg/kg	12		
Sulfate (SO4)	Saturated Paste	mg/kg	38.6		
TGR	Saturated Paste	T/ac	<0.1		
Soil Acidity					
pH	1:2 Soil:CaCl2 sol.	pH	6.2		
Water Soluble Parameters					
Chromium (VI)	Water Soluble	mg/kg	<0.10		0.1



Analytical Report

Bill To: Nichols Environmental (Canada) Project:
Report To: Nichols Environmental (Canada) ID: 16-442-CRY
17331-107 Ave NE Name: Remediation
Edmonton, AB, Canada Location: Snow Valley Edmonton
T5S 1E5 LSD:
Attn: Michael Harquail P.O.: 16-442-CRY
Sampled By: MAN Acct code:
Company: NECL

Lot ID: **1167994**
Control Number:
Date Received: Oct 21, 2016
Date Reported: Oct 29, 2016
Report Number: 2142375

Reference Number 1167994-5
Sample Date Oct 21, 2016
Sample Time NA
Sample Location
Sample Description BF-01
Matrix Soil

Analyte	Units	Results	Results	Results	Nominal Detection Limit
Mono-Aromatic Hydrocarbons - Soil					
Benzene	Dry Weight	mg/kg	<0.005		0.005
Toluene	Dry Weight	mg/kg	<0.02		0.02
Ethylbenzene	Dry Weight	mg/kg	<0.005		0.005
Total Xylenes (m,p,o)	Dry Weight	mg/kg	<0.03		0.03
Volatile Petroleum Hydrocarbons - Soil					
Extraction Date	Volatiles		26-Oct-16		
F1 C6-C10	Dry Weight	mg/kg	<10		10
F1 -BTEX	Dry Weight	mg/kg	<10		10
Extractable Petroleum Hydrocarbons - Soil					
Extraction Date	Total Extractables		26-Oct-16		
F2c C10-C16	Dry Weight	mg/kg	<50		50
F3c C16-C34	Dry Weight	mg/kg	<50		50
F4c C34-C50	Dry Weight	mg/kg	<100		100
F4HTGCc C34-C50+	Dry Weight	mg/kg	<100		100
% C50+		%	<5		
Silica Gel Cleanup					
Silica Gel Cleanup			Done		
Soil % Moisture					
Moisture	Soil % Moisture	% by weight	21.30		

Approved by: 
Randy Neumann, BSc
Vice President

Data have been validated by Analytical Quality Control and Exova's Integrated Data Validation System (IDVS).

Generation and distribution of the report, and approval by the digitized signature above, are performed through a secure and controlled automatic process.



Quality Control

Bill To: Nichols Environmental (Canada) Project:
Report To: Nichols Environmental (Canada) ID: 16-442-CRY
17331-107 Ave NE Name: Remediation
Edmonton, AB, Canada Location: Snow Valley Edmonton
T5S 1E5 LSD:
Attn: Michael Harquail P.O.: 16-442-CRY
Sampled By: MAN Acct code:
Company: NECL

Lot ID: **1167994**
Control Number:
Date Received: Oct 21, 2016
Date Reported: Oct 29, 2016
Report Number: 2142375

Extractable Petroleum Hydrocarbons - Soil

Blanks	Units	Measured	Lower Limit	Upper Limit	Passed QC
F2c C10-C16	ug/mL	0	-10	10	yes
F3c C16-C34	ug/mL	0	-30	30	yes
F4c C34-C50	ug/mL	0	-20	20	yes
F4HTGCc C34-C50+	ug/mL	0	-20	20	yes

Date Acquired: October 25, 2016

Calibration Check	Units	% Recovery	Lower Limit	Upper Limit	Passed QC
F2c C10-C16	ug/mL	86.56	80	120	yes
F3c C16-C34	ug/mL	97.44	80	120	yes
F4c C34-C50	ug/mL	91.44	80	120	yes
F4HTGCc C34-C50+	ug/mL	89.50	80	120	yes

Date Acquired: October 25, 2016

Metals Strong Acid Digestion

Blanks	Units	Measured	Lower Limit	Upper Limit	Passed QC
Boron	mg/L	0.0236	-0.05	0.07	yes
Antimony	ug/L	0.00344228	-0.1	0.2	yes
Arsenic	ug/L	-0.00337145	-0.2	0.2	yes
Barium	ug/L	0.0486898	-1	1	yes
Beryllium	ug/L	0.0136958	-0.1	0.1	yes
Cadmium	ug/L	0.00230717	-0.01	0.01	yes
Chromium	ug/L	-0.0653556	-0.5	0.5	yes
Cobalt	ug/L	0.00311232	-0.1	0.1	yes
Copper	ug/L	0.0256117	-0.6	1.2	yes
Lead	ug/L	0.0116445	-5.0	5.0	yes
Mercury	ug/L	0.00226323	-0.04	0.04	yes
Molybdenum	ug/L	0.0197224	-1.0	1.0	yes
Nickel	ug/L	0.0223316	-0.4	0.7	yes
Selenium	ug/L	-0.0134219	-0.3	0.3	yes
Silver	ug/L	0.0105924	-0.09	0.14	yes
Thallium	ug/L	0.00143678	-0.04	0.04	yes
Tin	ug/L	-0.268259	-0.4	0.4	yes
Uranium	ug/L	0.00253645	-0.5	0.5	yes
Vanadium	ug/L	-0.032747	-0.1	0.1	yes
Zinc	ug/L	0.878723	-1	1	yes

Date Acquired: October 24, 2016

Client Sample Replicates	Units	Replicate 1	Replicate 2	% RSD Criteria	Absolute Criteria	Passed QC
Antimony	mg/kg	0.8	0.7	20	0.4	yes
Arsenic	mg/kg	16.5	15.1	20	0.4	yes
Barium	mg/kg	200	195	20	2	yes
Beryllium	mg/kg	0.8	0.8	20	0.2	yes
Cadmium	mg/kg	0.85	0.79	20	0.02	yes



Quality Control

Bill To: Nichols Environmental (Canada) Project:
Report To: Nichols Environmental (Canada) ID: 16-442-CRY
17331-107 Ave NE Name: Remediation
Edmonton, AB, Canada Location: Snow Valley Edmonton
T5S 1E5 LSD:
Attn: Michael Harquail P.O.: 16-442-CRY
Sampled By: MAN Acct code:
Company: NECL

Lot ID: **1167994**
Control Number:
Date Received: Oct 21, 2016
Date Reported: Oct 29, 2016
Report Number: 2142375

Metals Strong Acid Digestion - Continued

Client Sample Replicates	Units	Replicate 1	Replicate 2	% RSD Criteria	Absolute Criteria	Passed QC
Chromium	mg/kg	24.1	26.2	20	1.1	yes
Cobalt	mg/kg	12.8	12.7	20	0.2	yes
Copper	mg/kg	35.7	32.6	20	2.2	yes
Lead	mg/kg	17.1	16.2	20	0.2	yes
Mercury	mg/kg	0.07	0.06	20	0.05	yes
Molybdenum	mg/kg	6.1	5.7	20	2.2	yes
Nickel	mg/kg	38.1	38.1	20	1.1	yes
Selenium	mg/kg	1.9	1.9	20	0.7	yes
Silver	mg/kg	0.2	0.2	20	0.22	yes
Thallium	mg/kg	0.24	0.23	20	0.11	yes
Tin	mg/kg	1.4	<1.0	20	2.2	yes
Uranium	mg/kg	3.2	3.2	20	1.1	yes
Vanadium	mg/kg	32.8	31.8	20	0.2	yes
Zinc	mg/kg	149	146	20	2	yes

Date Acquired: October 24, 2016

Control Sample	Units	Measured	Lower Limit	Upper Limit	Passed QC
Antimony	mg/kg	40.7	36.1	43.9	yes
Arsenic	mg/kg	41.8	36.3	43.9	yes
Barium	mg/kg	205	183	225	yes
Beryllium	mg/kg	20.3	17.4	22.2	yes
Cadmium	mg/kg	2.07	1.88	2.28	yes
Chromium	mg/kg	104	94.2	107.8	yes
Cobalt	mg/kg	21.0	17.0	23.0	yes
Copper	mg/kg	204	179.5	210.5	yes
Lead	mg/kg	20.3	18.6	21.8	yes
Mercury	mg/kg	2.98	2.24	4.16	yes
Molybdenum	mg/kg	214	174.8	234.8	yes
Nickel	mg/kg	104	91.6	108.4	yes
Selenium	mg/kg	38.7	36.6	43.4	yes
Silver	mg/kg	20.2	18.70	22.90	yes
Thallium	mg/kg	10.1	9.20	11.00	yes
Tin	mg/kg	209	185.9	215.9	yes
Uranium	mg/kg	102	86.0	116.0	yes
Vanadium	mg/kg	20.7	18.4	22.4	yes
Zinc	mg/kg	209	170	230	yes

Date Acquired: October 24, 2016

Antimony	mg/kg	4.5	3.4	5.8	yes
Arsenic	mg/kg	112	88.0	124.0	yes
Barium	mg/kg	255	202	292	yes
Beryllium	mg/kg	0.7	-1.1	2.5	yes
Cadmium	mg/kg	2.32	1.81	2.71	yes
Chromium	mg/kg	40.9	31.6	46.6	yes



Quality Control

Bill To: Nichols Environmental (Canada) Project:
Report To: Nichols Environmental (Canada) ID: 16-442-CRY
17331-107 Ave NE Name: Remediation
Edmonton, AB, Canada Location: Snow Valley Edmonton
T5S 1E5 LSD:
Attn: Michael Harquail P.O.: 16-442-CRY
Sampled By: MAN Acct code:
Company: NECL

Lot ID: **1167994**
Control Number:
Date Received: Oct 21, 2016
Date Reported: Oct 29, 2016
Report Number: 2142375

Metals Strong Acid Digestion - Continued

Control Sample	Units	Measured	Lower Limit	Upper Limit	Passed QC
Cobalt	mg/kg	15.2	11.6	15.6	yes
Copper	mg/kg	220	175.0	283.0	yes
Lead	mg/kg	133	106.0	154.0	yes
Mercury	mg/kg	0.33	0.25	0.45	yes
Molybdenum	mg/kg	3.1	1.9	3.7	yes
Nickel	mg/kg	68.8	51.8	84.2	yes
Selenium	mg/kg	0.8	0.3	0.9	yes
Silver	mg/kg	1	0.73	1.39	yes
Thallium	mg/kg	0.35	0.26	0.48	yes
Tin	mg/kg	3.0	2.2	5.2	yes
Uranium	mg/kg	1.2	1.0	1.5	yes
Vanadium	mg/kg	49.2	34.2	55.8	yes
Zinc	mg/kg	644	460	748	yes

Date Acquired: October 24, 2016

Mono-Aromatic Hydrocarbons - Soil

Blanks	Units	Measured	Lower Limit	Upper Limit	Passed QC
Benzene	ng	0	-0.005	0.005	yes
Toluene	ng	0	-0.06	0.06	yes
Ethylbenzene	ng	0	-0.030	0.030	yes
Total Xylenes (m,p,o)	ng	0	-0.09	0.09	yes
Styrene	ng	0	-0.030	0.030	yes

Date Acquired: October 25, 2016

Calibration Check	Units	% Recovery	Lower Limit	Upper Limit	Passed QC
Benzene	ng	98.80	85	115	yes
Toluene	ng	89.80	85	115	yes
Ethylbenzene	ng	90.00	85	115	yes
Total Xylenes (m,p,o)	ng	94.00	85	115	yes
Styrene	ng	86.00	85	115	yes

Date Acquired: October 25, 2016

PAH - Soil - Surrogate Recovery

Blanks	Units	Measured	Lower Limit	Upper Limit	Passed QC
Nitrobenzene-d5	%	104.27	23	130	yes
2-Fluorobiphenyl	%	108.73	30	130	yes
p-Terphenyl-d14	%	113.34	18	137	yes

Date Acquired: October 24, 2016

Polycyclic Aromatic Hydrocarbons - Soil

Blanks	Units	Measured	Lower Limit	Upper Limit	Passed QC
Naphthalene	ng/mL	0	-0.010	0.010	yes
Acenaphthylene	ng/mL	0	-0.05	0.05	yes



Quality Control

Bill To: Nichols Environmental (Canada) Project:
Report To: Nichols Environmental (Canada) ID: 16-442-CRY
17331-107 Ave NE Name: Remediation
Edmonton, AB, Canada Location: Snow Valley Edmonton
T5S 1E5 LSD:
Attn: Michael Harquail P.O.: 16-442-CRY
Sampled By: MAN Acct code:
Company: NECL

Lot ID: **1167994**
Control Number:
Date Received: Oct 21, 2016
Date Reported: Oct 29, 2016
Report Number: 2142375

Polycyclic Aromatic Hydrocarbons - Soil -

Continued

Blanks	Units	Measured	Lower Limit	Upper Limit	Passed QC
Acenaphthene	ng/mL	0	-0.05	0.05	yes
Fluorene	ng/mL	0	-0.05	0.05	yes
Phenanthrene	ng/mL	0	-0.01	0.01	yes
Anthracene	ng/mL	0	-0.003	0.003	yes
Fluoranthene	ng/mL	0	-0.01	0.01	yes
Pyrene	ng/mL	0	-0.01	0.01	yes
Benzo(a)anthracene	ng/mL	0	-0.01	0.01	yes
Chrysene	ng/mL	0	-0.05	0.05	yes
Benzo(b)fluoranthene	ng/mL	0	-0.05	0.05	yes
Benzo(b+j)fluoranthene	ng/mL	0	-0.05	0.05	yes
Benzo(k)fluoranthene	ng/mL	0	-0.05	0.05	yes
Benzo(a)pyrene	ng/mL	0	-0.05	0.05	yes
Indeno(1,2,3-c,d)pyrene	ng/mL	0	-0.05	0.05	yes
Dibenzo(a,h)anthracene	ng/mL	0	-0.05	0.05	yes
Benzo(g,h,i)perylene	ng/mL	0	-0.05	0.05	yes

Date Acquired: October 24, 2016

Calibration Check	Units	% Recovery	Lower Limit	Upper Limit	Passed QC
Naphthalene	ng/mL	101.80	80	120	yes
Acenaphthylene	ng/mL	101.00	80	120	yes
Acenaphthene	ng/mL	100.40	80	120	yes
Fluorene	ng/mL	101.20	80	120	yes
Phenanthrene	ng/mL	102.20	80	120	yes
Anthracene	ng/mL	101.20	80	120	yes
Fluoranthene	ng/mL	101.80	80	120	yes
Pyrene	ng/mL	101.40	80	120	yes
Benzo(a)anthracene	ng/mL	102.20	80	120	yes
Chrysene	ng/mL	99.80	80	120	yes
Benzo(b)fluoranthene	ng/mL	101.60	80	120	yes
Benzo(k)fluoranthene	ng/mL	97.40	80	120	yes
Benzo(a)pyrene	ng/mL	101.20	80	120	yes
Indeno(1,2,3-c,d)pyrene	ng/mL	101.20	80	120	yes
Dibenzo(a,h)anthracene	ng/mL	101.80	80	120	yes
Benzo(g,h,i)perylene	ng/mL	100.00	80	120	yes

Date Acquired: October 24, 2016

Client Sample Replicates	Units	Replicate 1	Replicate 2	% RSD Criteria	Absolute Criteria	Passed QC
Naphthalene	mg/kg	<0.010	<0.010	50	0.020	yes
Acenaphthylene	mg/kg	<0.05	<0.05	50	0.10	yes
Acenaphthene	mg/kg	<0.05	<0.05	50	0.10	yes
Fluorene	mg/kg	<0.05	<0.05	50	0.10	yes
Phenanthrene	mg/kg	<0.01	<0.01	50	0.02	yes
Anthracene	mg/kg	<0.003	<0.003	50	0.006	yes



Quality Control

Bill To: Nichols Environmental (Canada) Project:
Report To: Nichols Environmental (Canada) ID: 16-442-CRY
17331-107 Ave NE Name: Remediation
Edmonton, AB, Canada Location: Snow Valley Edmonton
T5S 1E5 LSD:
Attn: Michael Harquail P.O.: 16-442-CRY
Sampled By: MAN Acct code:
Company: NECL

Lot ID: **1167994**
Control Number:
Date Received: Oct 21, 2016
Date Reported: Oct 29, 2016
Report Number: 2142375

Polycyclic Aromatic Hydrocarbons - Soil -

Continued

Client Sample	Replicates	Units	Replicate 1	Replicate 2	% RSD Criteria	Absolute Criteria	Passed QC
Fluoranthene		mg/kg	<0.01	<0.01	50	0.02	yes
Pyrene		mg/kg	<0.01	<0.01	50	0.02	yes
Benzo(a)anthracene		mg/kg	<0.01	<0.01	50	0.02	yes
Chrysene		mg/kg	<0.05	<0.05	50	0.10	yes
Benzo(b)fluoranthene		mg/kg	<0.05	<0.05	50	0.10	yes
Benzo(k)fluoranthene		mg/kg	<0.05	<0.05	50	0.10	yes
Benzo(a)pyrene		mg/kg	<0.05	<0.05	50	0.10	yes
Indeno(1,2,3-c,d)pyrene		mg/kg	<0.05	<0.05	50	0.10	yes
Dibenzo(a,h)anthracene		mg/kg	<0.05	<0.05	50	0.10	yes
Benzo(g,h,i)perylene		mg/kg	<0.05	<0.05	50	0.10	yes

Date Acquired: October 24, 2016

Matrix Spike	Units	% Recovery	Lower Limit	Upper Limit	Passed QC
Naphthalene	mg/kg	105	70	130	yes
Acenaphthylene	mg/kg	95	70	130	yes
Acenaphthene	mg/kg	102	70	130	yes
Fluorene	mg/kg	98	70	130	yes
Phenanthrene	mg/kg	108	70	130	yes
Anthracene	mg/kg	95	70	130	yes
Fluoranthene	mg/kg	104	70	130	yes
Pyrene	mg/kg	105	70	130	yes
Benzo(a)anthracene	mg/kg	100	70	130	yes
Chrysene	mg/kg	102	70	130	yes
Benzo(b)fluoranthene	mg/kg	108	70	130	yes
Benzo(k)fluoranthene	mg/kg	110	70	130	yes
Benzo(a)pyrene	mg/kg	108	70	130	yes
Indeno(1,2,3-c,d)pyrene	mg/kg	104	70	130	yes
Dibenzo(a,h)anthracene	mg/kg	108	70	130	yes
Benzo(g,h,i)perylene	mg/kg	106	70	130	yes

Date Acquired: October 24, 2016

Salinity

Blanks	Units	Measured	Lower Limit	Upper Limit	Passed QC
Calcium	mg/L	0.1231	-0.4	0.5	yes
Magnesium	mg/L	0.059	-0.1	0.1	yes
Sodium	mg/L	0.0991	-0	2	yes
Potassium	mg/L	0.0495	-0.5	0.7	yes
Chloride	mg/L	2.5815	0	5	yes
Sulfate-S	mg/L	0.1508	-0	1	yes

Date Acquired: October 24, 2016

Control Sample	Units	Measured	Lower Limit	Upper Limit	Passed QC
Electrical Conductivity	dS/m	3.07	2.71	3.25	yes

Quality Control

Bill To: Nichols Environmental (Canada)	Project:	Lot ID: 1167994
Report To: Nichols Environmental (Canada)	ID: 16-442-CRY	Control Number:
17331-107 Ave NE	Name: Remediation	Date Received: Oct 21, 2016
Edmonton, AB, Canada	Location: Snow Valley Edmonton	Date Reported: Oct 29, 2016
T5S 1E5	LSD:	Report Number: 2142375
Attn: Michael Harquail	P.O.: 16-442-CRY	
Sampled By: MAN	Acct code:	
Company: NECL		

Salinity - Continued

Control Sample	Units	Measured	Lower Limit	Upper Limit	Passed QC
% Saturation	%	41	38	52	yes
Calcium	mg/L	686	584.8	744.9	yes
Magnesium	mg/L	142	121.8	154.8	yes
Sodium	mg/L	70	58	79	yes
Potassium	mg/L	21	17.8	24.6	yes
Chloride	mg/L	66	57	78	yes
Sulfate-S	mg/L	636	551	695	yes
Date Acquired: October 24, 2016					
Electrical Conductivity	dS/m	31.6	26.80	35.20	yes
Calcium	mg/L	247	230.2	261.4	yes
Magnesium	mg/L	98.5	92.8	102.8	yes
Sodium	mg/L	248	229	269	yes
Potassium	mg/L	249	229.4	265.4	yes
Chloride	mg/L	2100	1871	2231	yes
Sulfate-S	mg/L	150	139	157	yes
Date Acquired: October 24, 2016					

Soil Acidity

Client Sample Replicates	Units	Replicate 1	Replicate 2	% RSD Criteria	Absolute Criteria	Passed QC
pH	pH	3.2	3.2	0	0.3	yes
Date Acquired: October 24, 2016						
Control Sample	Units	Measured	Lower Limit	Upper Limit	Passed QC	
pH	pH	7.3	6.2	8.4	yes	
Date Acquired: October 24, 2016						

Volatile Petroleum Hydrocarbons - Soil

Blanks	Units	Measured	Lower Limit	Upper Limit	Passed QC
F1 C6-C10	ng	0	-10	10	yes
Date Acquired: October 25, 2016					

Water Soluble Parameters

Blanks	Units	Measured	Lower Limit	Upper Limit	Passed QC	
Chromium (VI)	mg/L	-0.003	-0.10	0.10	yes	
Date Acquired: October 24, 2016						
Client Sample Replicates	Units	Replicate 1	Replicate 2	% RSD Criteria	Absolute Criteria	Passed QC
Chromium (VI)	mg/kg	<0.10	<0.10	10	0.01	yes
Date Acquired: October 24, 2016						

Methodology and Notes

Bill To: Nichols Environmental (Canada)	Project:	Lot ID: 1167994
Report To: Nichols Environmental (Canada)	ID: 16-442-CRY	Control Number:
17331-107 Ave NE	Name: Remediation	Date Received: Oct 21, 2016
Edmonton, AB, Canada	Location: Snow Valley Edmonton	Date Reported: Oct 29, 2016
T5S 1E5	LSD:	Report Number: 2142375
Attn: Michael Harquail	P.O.: 16-442-CRY	
Sampled By: MAN	Acct code:	
Company: NECL		

Method of Analysis

Method Name	Reference	Method	Date Analysis Started	Location
1:5 Water Soluble Extraction	APHA	* Colorimetric Method, 3500-Cr B	24-Oct-16	Exova Edmonton
BTEX-CCME - Soil	CCME	* Reference Method for Canada-Wide Standard for PHC in Soil, CWS PHCS TIER 1	24-Oct-16	Exova Calgary
BTEX-CCME - Soil	US EPA	* Volatile Organic Compounds in Various Sample Matrices Using Equilibrium Headspace Analysis/Gas Chromatography Mass Spectrometry, 5021/8260	24-Oct-16	Exova Calgary
Metals ICP (Hot Block) in soil	EPA	* Sample Preparation Procedure for Spectrochemical Determination of Total Recoverable Elements, October 1999, 200.2	24-Oct-16	Exova Edmonton
Metals ICP (Hot Block) in soil	US EPA	* Determination of Trace Elements in Waters and Wastes by ICP-MS, 200.8	24-Oct-16	Exova Edmonton
PAH - Soil	AESRD	Index of Additive Cancer Risk (IACR), PAHs	24-Oct-16	Exova Calgary
PAH - Soil	US EPA	* Semivolatile Organic Compounds by Gas Chromatography/Mass Spectrometry, 8270	24-Oct-16	Exova Calgary
pH by CaCl ₂ (1:2 ratio) in soil	McKeague	* pH in 0.01M Calcium Chloride, 3.11	24-Oct-16	Exova Edmonton
Saturated Paste in General Soil	Carter	* Electrical Conductivity and Soluble Ions, Chapter 15	24-Oct-16	Exova Edmonton
TEH-CCME-Soil (Shake)	CCME	* Reference Method for Canada-Wide Standard for PHC in Soil, CWS PHCS TIER 1	24-Oct-16	Exova Calgary

* Reference Method Modified

References

AESRD	Alberta Tier 1 Soil and Groundwater Remediation Guidelines
APHA	Standard Methods for the Examination of Water and Wastewater
Carter	Soil Sampling and Methods of Analysis.
CCME	Canadian Council of Ministers of the Environment
EPA	Environmental Protection Agency Test Methods - US
McKeague	Manual on Soil Sampling and Methods of Analysis
US EPA	US Environmental Protection Agency Test Methods

Comments:

Methodology and Notes

Bill To: Nichols Environmental (Canada)	Project:	Lot ID: 1167994
Report To: Nichols Environmental (Canada)	ID: 16-442-CRY	Control Number:
17331-107 Ave NE	Name: Remediation	Date Received: Oct 21, 2016
Edmonton, AB, Canada	Location: Snow Valley Edmonton	Date Reported: Oct 29, 2016
T5S 1E5	LSD:	Report Number: 2142375
Attn: Michael Harquail	P.O.: 16-442-CRY	
Sampled By: MAN	Acct code:	
Company: NECL		

Please direct any inquiries regarding this report to our Client Services group.

Results relate only to samples as submitted.

The test report shall not be reproduced except in full, without the written approval of the laboratory.

Analytical Report

Bill To: Nichols Environmental (Canada)	Project:	Lot ID: 1167994
Report To: Nichols Environmental (Canada)	ID: 16-442-CRY	Control Number:
17331-107 Ave NE	Name: Remediation	Date Received: Oct 21, 2016
Edmonton, AB, Canada	Location: Snow Valley Edmonton	Date Reported: Oct 29, 2016
T5S 1E5	LSD:	Report Number: 2142375
Attn: Michael Harquail	P.O.: 16-442-CRY	
Sampled By: MAN	Acct code:	
Company: NECL		

Petroleum Hydrocarbons in Soil

Batch Notes

1. The method used complies with the Reference Method for the Canada Wide Standards for Petroleum Hydrocarbons in Soil - Tier 1, April 2001, including Addendum 1, and is accredited for use in Exova.
2. Modifications of the method: See Notes and Methodology for nonconformances (if applicable).
3. Qualifications on results: See Notes and Methodology for nonconformances (if applicable).
4. Silica gel treatment is performed for fractions F2, F3, F4.
5. F1-BTEX: BTEX has been subtracted from the F1 fraction.
6. If analyzed, naphthalene has been subtracted from fraction F2 and selected PAHs have been subtracted from fraction F3.
7. F4HTGC is reported when more than 5% of the total carbon envelope elutes past C₅₀.
8. Exova does not routinely report Gravimetric Heavy Hydrocarbons (F4G or F4G-sg), F4HTGC through extended range high temperature GC is reported instead.
9. When both F4(C₃₄-C₅₀) and F4HTGC are reported, F4HTGC is the final F4 that is to be used for interpreting the CWS.
10. Quality criteria met for the batch: Data is reported in Quality Control Section of report (if requested).
 - nC₆ and nC₁₀ response factors (RF) are within 30% of RF for toluene
 - nC₁₀, nC₁₆ and nC₃₄ RFs are within 10% of each other
 - nC₅₀ RF is within 30% of the average RF for nC₁₀+nC₁₆+nC₃₄
 - linearity is within 15% for each of the calibrated carbon ranges
11. Batch data for analytical quality control are available on request.
12. Extraction and analysis holding times were met: See Notes and Methodology for nonconformances (if applicable).

Approved by:



Randy Neumann, BSc
Vice President

Data have been validated by Analytical Quality Control and Exova's Integrated Data Validation System (IDVS).

Generation and distribution of the report, and approval by the digitized signature above, are performed through a secure and controlled automatic process.

Hydrocarbon Chromatogram

Bill To: Nichols Environmental (Canada)	Project ID: 16-442-CRY	Lot ID: 1167994
Report To: Nichols Environmental (Canada)	Name: Remediation	Control Number:
17331-107 Ave NE	Location: Snow Valley Edmonton	Date Received: Oct 21, 2016
Edmonton, AB, Canada	LSD:	Date Reported: Oct 28, 2016
T5S 1E5	P.O.: {Project ID}	Report Number: 2142375
Attn: Michael Harquail		
Sampled by: MAN		
Company: NECL		

Exova Number: 1167994-5
 Sample Date: Oct 21, 2016

Sample Description: BF-01

Silica Gel Treated

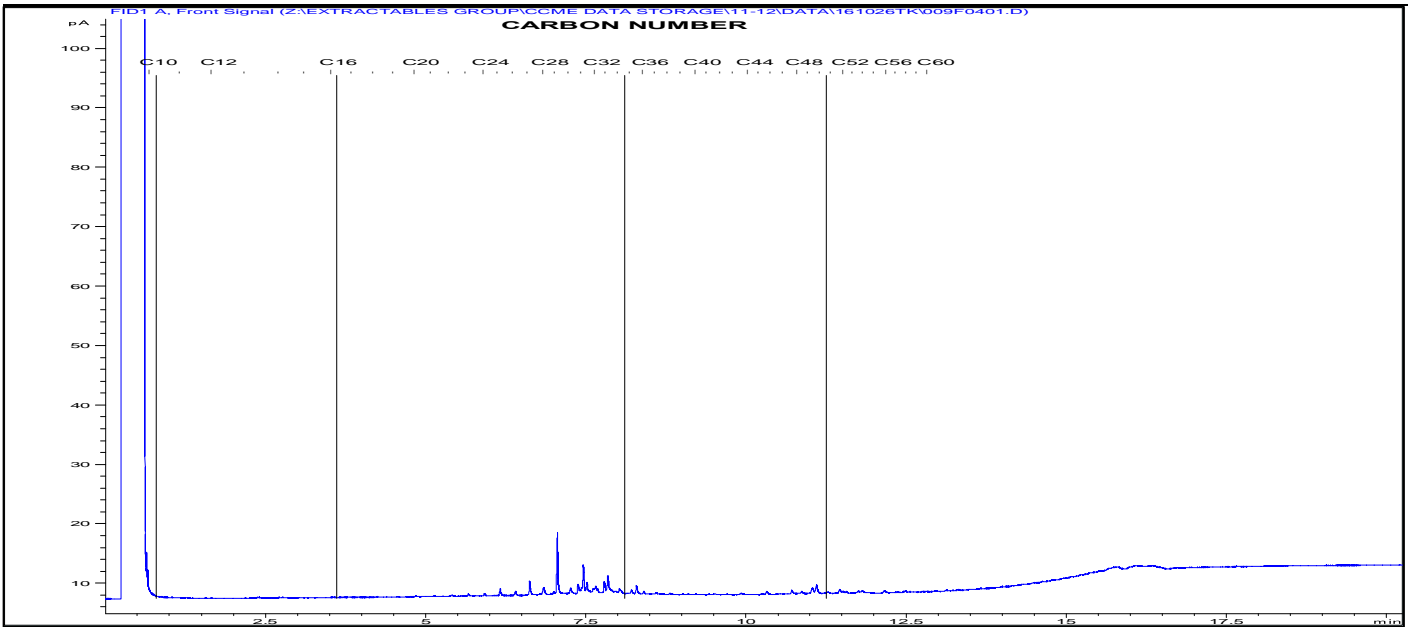

TYPICAL PRODUCT CHROMATOGRAMS

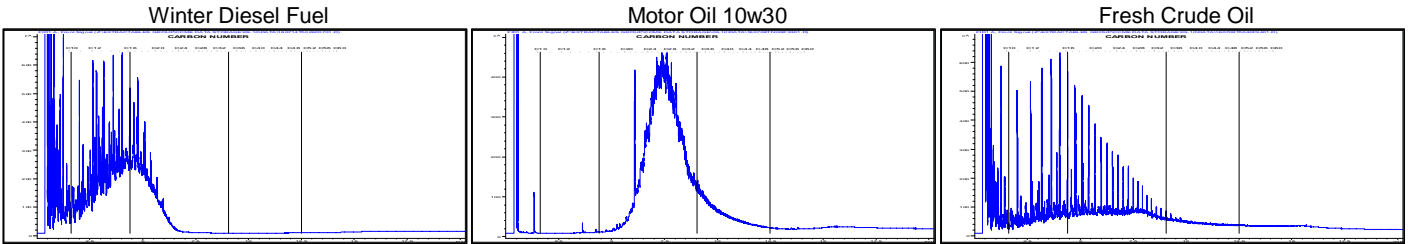

Product Carbon Number Ranges

Gasoline	C4-C12	Kerosene	C7-C16	Lubricating Oils	C20-C40
Varsol	C8-C12	Diesel	C8-C22	Crude Oils	C3-C60+

Invoice to:		Report To:		Report Results		Regulatory Requirement	
Company:	Nichols Env.	Company:		E-Mail	<input checked="" type="checkbox"/>	HCDWQG	<input checked="" type="checkbox"/>
Address:		Address:		Mail	<input type="checkbox"/>	Ab Tier 1	<input checked="" type="checkbox"/>
Attention:	Mikel Hasgrat	Attention:		Online	<input type="checkbox"/>	SPIGEC	
Phone:	307 222 1234	Phone:		Fax	<input type="checkbox"/>	BCCSR	
Cell:		Cell:		PDF	<input checked="" type="checkbox"/>	Other (list below)	
Fax:		Fax:		Excel	<input checked="" type="checkbox"/>		
E-mail:		E-mail 1:		QA/QC	<input checked="" type="checkbox"/>		
Agreement ID:		E-mail 2:		Sample Custody (please print)			
Copy of report:		Copy of invoice:		Sampled by: MAN			

RUSH Priority

Emergency (contact lab for turnaround and pricing)
 Priority 1-2 working days (100% surcharge)
 Urgent 2-3 working days (50% surcharge)

When "ASAP" is requested, turn around will default to a 100% RUSH priority, with pricing and turn around time to match. Please contact the lab prior to submitting RUSH samples. If not all samples require RUSH, please indicate in the special instructions.

Number of Containers
 PAN
 BTEX PHCLFTH
 Salinity
 Metals

Company: NECL

This section for Lab use only

Date/Time stamp:
 OCT 21 PM 3:20

Site I.D.	Sample Description	Depth start end in cm m	Date/Time Sampled	Matrix	Sampling Method	Enter tests above (✓ relevant samples below)	Indicate in the space allotted any deficiencies by the corresponding number.
1	SA-33	0.15	Oct 21	Soil	grab	/	1. Indicate any samples that were not packaged well
2	SA-34	0.25	↓	↓	↓	/	2. Indicate any samples not received in Exova supplies
3	SA-35	0.15	↓	↓	↓	/	3. Indicate any samples that were not clearly labeled
4	SA-36	0.8	↓	↓	↓	/	4. Indicate any samples not received within the required hold time or temp.
5	BP-01					2 / / /	5. Indicate any missing or extra samples
6							6. Indicate any samples that were received broken
7							7. Indicate any samples where sufficient volume was not received
8							8. Indicate any samples received in an inappropriate container
9							
10							
11							
12							
13							
14							
15							

Submission of this form acknowledges acceptance of Exova's Standard Terms and Conditions (<http://www.exova.com/about/terms-and-conditions/>)

Please indicate any potentially hazardous samples

Page _____ of _____ Control # **C 0098774**

Lot: 1167994 ^{COC}



Shipping: COD Y/ N

and size of coolers

Temp. received: 9.8

Delivery Method: *Med*

Waybill:

Received by: *AB*

ED 120-02

APPENDIX L - PETROLEUM TANK MANAGEMENT ASSOCIATION OF ALBERTA



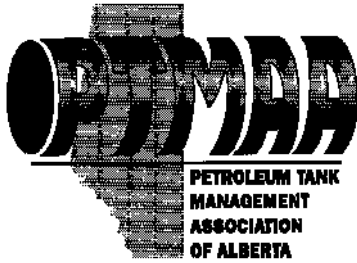

Petroleum Tank Management
Association of Alberta

Suite 980, 10303 Jasper Avenue
Edmonton, Alberta T5J 3N6
PH: (780)425-8265 or 1-866-222-8265
FAX: (780)425-4722

April 24, 2020

Danielle Loiselle
Associated Environmental
5-Coulee Park SW
Calgary, AB T3H 5J5

Dear Danielle Loiselle:

As per your request, the PTMAA has checked the registration of active tank sites and inventory of abandoned tank sites and there are no records for the property with the legal land description:

13204-Rainbow Valley Rd NW, Edmonton
Plan 4002MC, lot R

Please note that both databases are not complete. The main limitation of these databases is that they only include information reported through registration or a survey of abandoned sites completed in 1992 and should not be considered as a comprehensive inventory of all past or present storage tank sites. The PTMAA cannot guarantee that tanks do not or have not existed at this location. Information in the databases is based on information supplied by the owner and the PTMAA cannot guarantee its accuracy. Information on storage tanks or on past or present contaminant investigations may be filed with the local Fire Department or Alberta Environment.

Yours truly,

Gonnie Jacobsen
PTMAA

APPENDIX M - SITE PHOTOGRAPHS



Associated
Engineering

GLOBAL PERSPECTIVE.
LOCAL FOCUS.

Site Photographs



Photograph 1 – Facing southeast from Talus Dome along WMD, storm pond along Fort Edmonton Park Road.
April 22, 2020.



Associated
Engineering

GLOBAL PERSPECTIVE.
LOCAL FOCUS.



Photograph 2 – Facing southwest to WMD-Fox Drive interchange, debris along ramp. April 22, 2020.



Associated
Engineering

GLOBAL PERSPECTIVE.
LOCAL FOCUS.



Photograph 3 – Facing north from 53 Avenue bridge, salt staining on WMD. April 22, 2020.



Associated
Engineering

GLOBAL PERSPECTIVE.
LOCAL FOCUS.



Photograph 4 – Facing northwest from WMD-Terwillegar Drive interchange, salt staining and non-vegetated area along southbound Terwillegar Drive. April 22, 2020.



Associated
Engineering

GLOBAL PERSPECTIVE.
LOCAL FOCUS.



Photograph 5 – Facing southwest from WMD-Terwillegar Drive interchange, trash bag and debris along southbound WMD. April 22, 2020.



Associated
Engineering

GLOBAL PERSPECTIVE.
LOCAL FOCUS.



Photograph 6 – Facing northwest toward RVB, soil erosion and debris. April 22, 2020.



Associated
Engineering

GLOBAL PERSPECTIVE.
LOCAL FOCUS.



Photograph 7 – Facing southeast toward RVB, catch basin, box containing gravel, and cracks in lower concrete.
April 22, 2020.



Associated
Engineering

GLOBAL PERSPECTIVE.
LOCAL FOCUS.



Photograph 8 – Facing northwest from RVB toward Snow Valley Ski Club and Whitemud Creek.
April 22, 2020.



Associated
Engineering

GLOBAL PERSPECTIVE.
LOCAL FOCUS.



Photograph 9 – Facing west from 122 Street Bridge, salt staining on WMD. April 22, 2020.

APPENDIX N - STANDARD DISCLAIMER

ASSOCIATED ENGINEERING ALBERTA LTD.

STANDARD DISCLAIMER FOR CONTAMINATED SITE INVESTIGATIONS, MONITORING AND CONFIRMATION OF REMEDIATION SERVICES

Subject to the following conditions and limitations, the investigation described in this report has been conducted by Associated Engineering Alberta Ltd. (Associated) for the City of Edmonton (the Client) in a manner consistent with a reasonable level of care and skill normally exercised by members of the environmental science profession currently practicing under similar conditions in the area.

1. The scope of the investigation described in this report has been limited by the budget set for the investigation in the work program. The scope of the investigation has been reasonable having regard to that budget constraint.
2. The investigation described in this report has been limited to the scope of work described in the work program.
3. The investigation described in this report has relied upon information provided by third parties concerning the history of the site. Except as stated in this report, we have not made an independent verification of such historical information.
4. The investigation described in this report has been made in the context of existing government regulations generally promulgated at the date of this report. Except as specifically noted, the investigation did not take account of any government regulations not in effect and generally promulgated at the date of this report.
5. All documents and drawings prepared by Associated, or by others on behalf of Associated, in connection with this Project are instruments of professional service for the execution of the Project. Associated retains the property and copyright in these documents and drawings, whether the Project is executed or not.
6. The findings and conclusions are valid only for the specific site identified in the report.
7. Since site conditions may change over time, the report is intended for immediate use.
8. This report is intended for the exclusive use of the Client, including all successors and assigns. The material in it reflects Associated's best judgement, in light of the information available to it, at the time of preparation. Any use that a third party makes of this report, or any reliance on or decisions to be made based on it, are the responsibility of such third parties. Associated accepts no responsibility for damages, if any, suffered by any third party as a result of decisions made or actions based on this report and makes no representation of fact or opinion of any nature whatsoever to any person or entity other than the Client.

In accepting delivery of this report, the Client hereby agrees that:

- A. Associated's liability for all claims of the Client, arising out of the agreement between Associated and the Client, pursuant to which this report has been prepared (the Agreement) shall absolutely cease to exist after a period of six (6) years from the date of:
 - i. substantial completion of the investigation described in this report,
 - ii. termination of Associated's Services under the Agreement,
 - iii. commencement of the limitation period for claims prescribed by any statute of the Province or Territory for the site of the investigation described in this report,
 - iv. any significant alteration of the site of the investigation described in this report, and/or neighbouring properties after the date of the final report that would change the conclusions and recommendations of the final report,

whichever shall first occur, and following the expiration of such period, the Client shall have no claim whatsoever against Associated.

- B. Any and all claims that it may have against Associated's or any of its servants, agents, or employees arising out of or in any way connected with the investigation described in this report or the preparation of this report, whether such claims are in contract or in tort, and whether such claims are based on negligence or otherwise, shall be limited to a total amount equal to the fees payable to Associated's under the contract with the Client. Associated's shall bear no liability whatsoever for any consequential loss, injury or damage incurred by the Client including but not limited to claims for loss of profits and loss of markets.

APPENDIX E - PHASE II ENVIRONMENTAL SITE ASSESSMENT



Issue Date:	November 19, 2021	File No.:	2021-3981
To:	Reg Ball	Previous Issue Date:	
From:	Brent Schmidt, P.Geo	Project No.:	2021-3981
Client:	CIMA+		
Project Name:	Terwillegar Drive Stage 2		
Subject:	Phase II Environmental Site Assessment		

Dear Reg:

1 INTRODUCTION

Associated Engineering (Associated) was retained by CIMA+ to conduct a Phase II Environmental Site Assessment (ESA) as part of the Terwillegar Drive Stage 2 Upgrades and Rainbow Valley Bridge Renewal. The assessed area includes a 4.9 km segment of Whitemud Drive (WMD) freeway from the Fox Drive interchange to 122 Street NW interchange in Edmonton, Alberta (Project Area) (Figure 1). The Stage 2 Upgrades will include upgrading the WMD-Terwillegar Drive interchange, widening WMD between Fox Drive and 122 Street, rehabilitating and widening of the Rainbow Valley Bridges (RVB), and adding a bus-only lane between 53 Avenue and Terwillegar Drive.

In 2020, Associated completed a Limited Phase I ESA¹ for the Project Area and identified potential contaminants of concern (PCOCs) including salts, metals, petroleum hydrocarbons (PHCs) and polycyclic aromatic hydrocarbons along the freeway right-of-way (ROW). Additionally, a former fire that occurred on the RVB in 2016 indicated the potential for Per and Polyfluoroalkyl Substances (PFAS) and Perfluorooctanic Acid (PFOA) from fire fighting foam in the spills area beneath the bridges (Associated 2020).

The objective of the Phase II ESA was to assess shallow soil quality along WMD and identify contaminants of concern (COCs) that may be encountered during project earthworks and construction.

This report is subject to Associated's standard disclaimer for environmental investigations and generally conformed to the Canadian Standards Association (CSA) Z769-00 (R2018) – Phase II Environmental Site Assessment (CSA 2018), Alberta Environmental Site Assessment Standard², and City of Edmonton Environmental Site Assessment Guidebook³.

https://aeris.ae.ca/DMS/view_document.aspx?ID=6412774&Latest=true

¹ Associated Engineering. 2020. Limited Phase I Environmental Site Assessment – Rainbow Valley Bridges Renewal & Widening / Terwillegar Drive Stage 2 Upgrades. 2019-3585.

² Alberta Environment and Parks (AEP). 2016. Alberta Environmental Site Assessment Standards. Available online at: <https://open.alberta.ca/dataset/3acc7cff-8c50-44e8-8a33-f4b710d9859a/resource/579321b7-5b66-4022-9796-31b1ad094635/download/environmentsiteassessstandard-mar01-2016.pdf>

³ City of Edmonton. 2016. Environmental Site Assessment Guidebook. Available online at: <https://www.edmonton.ca/sites/default/files/public-files/assets/ESAGuidebook.pdf>



Memo To: Reg Ball, CIMA+
November 19, 2021
Page 2

2 SCOPE

The following activities were conducted as part of the Phase II ESA:

- Advance 30 hand auger test holes (21HA01 through 21HA30) at select locations along WMD and below RVB;
- Collect soil samples and field screen for volatile organic compounds (VOCs) and electrical conductivity (EC);
- Submit select soil samples based on field observations and field screening results to an analytical laboratory to quantify concentrations of PCOCs;
- Compare analytical results to applicable environmental standards and guidelines; and
- Prepare a report summarizing the results with respect to the applicable guidelines.

The majority of upgrades and construction are within the existing ROW and within the upper two metres below ground surface (mbgs). Based on available information, groundwater is not expected to be encountered during construction and therefore groundwater quality was not assessed as part of this ESA.

3 SITE DESCRIPTION

The following sections describe the Project Area applicable to the Phase II ESA. Further details are provided in the Limited Phase I ESA (Associated 2020).

3.1 Location

The Project Area covers a 4.9 km segment of the WMD freeway and ranges from approximately 100 to 200 m in width. Currently, the freeway is divided and has three lanes of traffic going in both directions.

The Site intersects the following Alberta Township Survey System sections:

- NW-07-52-24-W4M
- SW-18-52-24-W4M
- NE-11-52-25-W4M
- NW & NE-12-52-25-W4M
- SW & SE-13-52-25-W4M
- NE & SE-14-52-25-W4M
- SE-23-52-25-W4M
- SW-24-52-25-W4M



Memo To: Reg Ball, CIMA+
November 19, 2021
Page 3

3.2 Topography

Topography varies across the Project Area⁴. At the north end, in the North Saskatchewan River valley, the elevation of Fox Drive is approximately 630 metres above sea level (masl). To the south of the WMD Fox Drive interchange, above the valley, elevation increases to approximately 660 masl and then gently slopes up to approximately 675 masl at the WMD Terwillegar Drive Interchange. East of this interchange the elevation slopes down gradually to 660 masl before dropping down to approximately 630 masl in the Whitemud Creek valley at the RVB. East of the RVB, elevation climbs back up to approximately 660 masl above the valley and slopes up gradually to approximately 665 masl at 122 Street.

3.3 Surface Water Drainage, Nearby Receptors, and Hydrogeology

Surface water drainage in the Project Area generally follows topography. The north portion drains towards the North Saskatchewan River, approximately 60 m north of the north Site boundary. The southwest and east portions of the Site drain into Whitemud Creek, which flows north into the North Saskatchewan River approximately 2,500 m north of the RVB (Natural Resources Canada 2021).

Shallow groundwater beneath the Project Area is inferred to generally mimic topography, flowing north towards the North Saskatchewan River near the WMD-Fox Drive interchange, and towards Whitemud Creek throughout the rest of the Project Area. The inferred groundwater flow direction is a good approximation, however, a monitoring well network would verify the actual flow direction, which was not part of this scope.

3.4 Geology

Surficial geology primarily consists of glaciolacustrine deposits (i.e. sediments associated with former glacial lakes), that range from massive fine-grained sand, silt and clay for offshore sediments, to silty or pebbly sand with gravel for nearshore sediments⁵. The glaciolacustrine deposits overlie glacial till, consisting of mixed clay, silt, sand, gravel and boulders. The glaciolacustrine deposits have been eroded by Whitemud Creek and the North Saskatchewan River, and reach approximately 9 m in thickness near Terwillegar Drive and 122 Street interchanges^{6,7}. Stratigraphy within the Whitemud Creek valley is bedrock at the lowest elevation, overlain by 5 to 15 m of glacial till and approximately 5 to 10 m of glaciolacustrine deposits at the surface.

Surficial deposits within Whitemud Creek consist of gravel, sand, silt and clay alluvium (i.e. deposited by streams), and surficial deposits within the North Saskatchewan River consist of gravel, sand and silt alluvium. Both the Whitemud Creek and North Saskatchewan River valley slopes consist of colluvial sediments (i.e. displaced by gravity) from stream alluvium, and mixed glacial and bedrock materials.

⁴ Government of Canada. 2021. The Atlas of Canada – Toporama. Available online at: <https://atlas.gc.ca/toporama/en/index.html>

⁵ Fenton, M.M. Waters, E.J. Pawley, S.M. Atkinson, N. Utting, D.J. McKay, K. 2013. Surficial Geology of Alberta. Alberta Energy Regulator, ARE/AGS Map 601, Scale 1:1,000,000.

⁶ Andriashek, L.D. MacMillan, R.A. 1981. Preliminary Report on the Urban Geology of the Annexed areas in Edmonton. Available online at: https://ags.aer.ca/publications/OFR_1982_01.html

⁷ Kathol, C.P. McPherson, R.A. 1975. Urban Geology of Edmonton. Available online at: https://ags.aer.ca/publications/BUL_032.html

Memo To: Reg Ball, CIMA+
November 19, 2021
Page 4

The bedrock geology of the Site consists of sandstone interbedded with siltstones, mudstones, and coal seams of the Upper Cretaceous Horseshoe Canyon Formation⁸.

4 REGULATORY FRAMEWORK

Soil and groundwater contamination in Alberta are addressed under the Environmental Protection and Enhancement Act (EPEA) (RSA 2000, c. E-12). The 2019 *Alberta Tier 1 Soil and Groundwater Remediation Guidelines* (AT1 Guidelines)⁹ were considered for interpretation of environmental risk.

The AT1 Guidelines consider all human and ecological exposure pathways and is a conservative first step in defining soil-based contamination. They consider both the primary land use(s) of a site and soil particle size. Sample locations within 30 m of a neighbouring property with a more sensitive land use must also be considered during guideline selection.

The Project Area is considered commercial land use and consists of paved roads, bridges, and associated ROWs bordering residential/parkland areas. Particle size analysis determined that the soils are primarily fine-grained.

Based on the available site information, soil analytical results were compared to the 2019 AT1 Guidelines for fine-grained soils under commercial land use. Test hole locations 21HA16, 21HA17, and 21HA19 were compared to residential/parkland land use guidelines as they are within the Rainbow Valley Park and in proximity to Whitemud Creek.

There were no AT1 Guidelines for PFAS and PFOA which were analyzed at test holes 21HA13, 21HA14, and 21HA15. Therefore, the following guidelines were compared to for these parameters:

- British Columbia (BC) Contaminated Sites Regulation (CSR). Schedule 3.3. Generic Numerical Soil Standards (BC Reg. 375/96)¹⁰ (Low Density Residential Land Use);
- Canadian Council of Ministers of the Environment (CCME) – Canadian Environmental Quality Guidelines: Soil Quality Guidelines for the Protection of Environmental and Human Health¹¹; and
- Health Canada - Updates to Health Canada Soil Screening Values for Perfluoroalkylated Substances (PFAS).

⁸ Prior, G.J. Hathaway, B. Glombick, O.M. Pana, D.I. Banks, C.J. Hay, D.C. Schneider, C.L. Grobe, M. Elgr, R. Weiss, J.A. 2013. Bedrock Geology of Alberta. Alberta Energy Regulator, AER/AGS Map 600, Scale 1:1,000,000.

⁹ Alberta Environment and Parks (AEP). 2019. Alberta Tier 1 Soil and Groundwater Remediation Guidelines. Available online at: <https://open.alberta.ca/dataset/842becf6-dc0c-4cc7-8b29-e3f383133ddc/resource/a5cd84a6-5675-4e5b-94b8-0a36887c588b/download/albertatier1guidelines-jan10-2019.pdf>

¹⁰ BC CSR (RLLD) - British Columbia (BC) Contaminated Sites Regulation (CSR). Schedule 3.3. Generic Numerical Soil Standards (BC Reg. 375/96) (Low Density Residential Land Use).

¹¹ Canadian Council of Ministers of the Environment (CCME). Canadian Environmental Quality Guidelines: Soil Quality Guidelines for the Protection of Environmental and Human Health. Final Proposed Federal Soil Quality Guideline. Residential/Parkland land use for fine-grained surface soil.



Memo To: Reg Ball, CIMA+
November 19, 2021
Page 5

5 METHODS

5.1 Work Site Safety

Prior to the start of fieldwork, multiple requests were submitted to Alberta One Call on May 17, 2021, to identify and locate underground infrastructure within the proposed work areas (Ticket # 20212105300, 20212105366, 20212105427, 20212105470, 20212105526, 20212105559, 20212105680). A private line locator (Hawkeye Line Locators) verified and marked all underground services within a 30 m radius of each proposed test hole between May 29-31, 2021.

An On-Street Construction and Maintenance (OSCAM) Permit (P2021-003449) was obtained from the City of Edmonton, as required by Traffic Bylaw 5590.

A pre-job safety meeting was conducted by Associated to outline the scope of work, on-site hazards, required personal protective equipment, and traffic safety.

5.2 Soil Sampling

Between June 2 and 4, 2021, a total of 30 test holes (21HA01 through 21HA30) were advanced to a maximum depth of 1.3 mbgs to investigate on-site soil conditions and to recover representative soil samples for laboratory analysis. The test holes were advanced using an Edelman hand auger and soil samples were recovered at two depth intervals (0.0-0.3 mbgs and 0.6-1.0 mbgs). Test holes 21HA13 through 21HA15 were sampled from 1.0-1.3 mbgs below the reported backfill soils depth from the 2016 diesel spill and fire remediation. Upon completion, each test hole was backfilled with auger cuttings up to the ground surface.

At each test hole location, soils were logged including but not limited to:

- Soil textures and changes (depths) in soil stratigraphy;
- Sample intervals;
- Field indicators of contamination (e.g., odours, discolouration, staining, sheens); and
- Field screening results.

Soils were logged in general accordance with the unified soil classification system as provided in *American Society for Testing and Materials Standard D2488* (ASTM 2017). Soil logging, sampling and preservation procedures followed standards outlined in *Guidance Manual on Sampling, Analysis, and Data Management for Contaminated Sites Volume 1: Main Report*¹².

¹² Canadian Council of Ministers of the Environment. December 1993. *Guidance Manual on Sampling Analysis, and Data Management for Contaminated Sites. Volume I: Main Report.*



Memo To: Reg Ball, CIMA+
November 19, 2021
Page 6

Each sample was field screened for salinity using a portable EC probe. Soils were also screened for organic vapours using an RKI EAGLE portable gas detector calibrated to hexane. The field protocols and quality control and quality assurance (QA/QC) procedures followed by Associated were in accordance with industry best practice protocols.

Soil samples were selected for laboratory analysis based on field screening results. Soil samples were collected in laboratory-supplied containers using nitrile gloves to decrease the potential for cross-contamination. Terracore™ soil samplers and pre-weighted vials with methanol preservation were used to collect samples that were submitted for volatile hydrocarbons. All soil samples were placed in laboratory-supplied coolers with ice and submitted to ALS Environmental in Edmonton, AB together with chain-of-custody documentation. Samples selected for analysis were analyzed for one or more of the following PCOCs:

- Detailed salinity (including EC, SAR, chloride, sodium, sulphate, calcium, magnesium, and potassium);
- Metals;
- BTEX (benzene, toluene, ethylbenzene, xylenes) and PHC fractions F1-F4;
- Polycyclic aromatic hydrocarbons (PAHs); and
- PFAS and PFOA.

Six samples, 21HA04(0.0-0.3m), 21HA02(0.6-1.0m), 21HA11(0.6-1.0m), 21HA12(0.6-1.0m), 21HA24(0.6-1.0m), and 21HA27(0.0-0.3m) were analyzed for particle size to determine the applicable regulatory guidelines.

Test holes were evenly distributed throughout the Project Area to provide a general understanding of on-site soil conditions that will be encountered during construction. With the exception of test holes beneath the RVB, test holes were completed within 3 m of nearby roadways where it was safe to access and clear of underground facilities. Table 5-1 provides a summary of the test holes completed.

Memo To: Reg Ball, CIMA+
November 19, 2021
Page 7

Table 5-1
Test Hole Summary

Test hole	Location	Analyses	
21HA01 21HA02 21HA03 21HA05 21HA06 21HA07	Southbound WMD Fox Drive to 53 Ave NW	Select samples analyzed for detailed salinity, metals, BTEX and PHC fractions F1-F4, and / or PAHs	
21HA08 21HA09	Southbound WMD 53 Ave NW to Terwilliger Drive Overpass		
21HA10 21HA11	Eastbound WMD Terwilliger Drive to Rainbow Valley Bridge		
21HA12 21HA30	Eastbound WMD Rainbow Valley Bridge to 122 St NW		
21HA21 21HA22 21HA18	Westbound WMD 122 St NW to Rainbow Valley Bridge		
21HA20 21HA23 21HA24	Westbound WMD Rainbow Valley Bridge to Terwilliger Drive		
21HA25 21HA26	Northbound WMD Terwilliger Drive to 53 Ave NW		
21HA27 21HA28 21HA29 21HA04	Northbound WMD 53 Ave NW to Fox Drive		
21HA16 21HA17 21HA19	Beneath Rainbow Valley Bridges		
21HA13 21HA14 21HA15	Beneath Rainbow Valley Bridges at remediated former diesel spill location		PFAS and PFOA



Memo To: Reg Ball, CIMA+
November 19, 2021
Page 8

5.3 Quality Assurance / Quality Control

Comprehensive QA/QC measures were followed to ensure high-quality soil sampling and data. The following protocols were used to collect samples:

- Wearing a new pair of disposable nitrile gloves for collecting and handling each sample;
- Cleaning the soil sampling equipment between each sampling interval;
- Using laboratory-supplied sampling containers which are appropriate for the selected analytes;
- Keeping the sealed samples in a cooler filled with ice packs;
- Shipping the samples to ALS on time, respecting the samples' holding-time and receiving temperature requirements specified as part of the laboratory QA/QC measures; and
- Collecting and analyzing three field duplicates, which provide information about the combined (field and analytical) precision of the sampling and analytical program.

ALS Environmental follows internal QA/QC procedures to ensure data are reliable. Common quality control measures are run at 5–10% frequency, and these include the use of method blanks (Blk), duplicates (Dup), blank spikes (BS), and standard reference materials (SRM). Further information about the laboratory's QA/QC procedures is provided in the laboratory reports (Appendix C).

Collection and analysis of duplicate samples provide information about the combined (field and analytical) precision of the sampling and analytical program. Duplicate soil samples were collected in the field at a 10% frequency. For each respective analyte, the results for each sample in the duplicate pair (*a* and *b*, respectively in the formula below) were compared and the relative percent difference (RPD) was calculated using the formula:

$$RPD = \left(\frac{(a - b)}{\left(\frac{a + b}{2}\right)} \right) \times 100$$

The RPD calculations were completed when both sample-duplicate values were equal to or greater than five times the laboratory method detection limit (MDL). An RPD value of 50% was selected as the target data quality objective for QA/QC analysis.

6 RESULTS

6.1 Soils

A total of 30 test holes were advanced on site. Most of the soil encountered was fine-grained material consisting of silty clay, with trace fine-grained sand and trace fine gravel. Test hole logs are provided in Appendix A. Site photos are provided in Appendix B.



Memo To: Reg Ball, CIMA+
November 19, 2021
Page 9

6.2 Field Screening

Most vapour readings were 0 or 1 parts per million (ppm), with one reading of 2 ppm (21HA22(0.0-0.3m)). Soil EC measurements ranged from 0.44 deciSiemens per metre (dS/m) (21HA07(0.6-1.0m) to 11.58 dS/m (21HA19(0.0-0.3m)).

6.3 Analytical

Soil analytical results compared to the applicable guidelines are provided in Tables 1 through 3.

The following summarizes the analytical results:

- Electrical conductivity and/or SAR exceeded the commercial land use AT1 Salt Remediation Guidelines in all 27 test holes analyzed for salinity. For commercial land use, there are only single guideline values for both EC and SAR (4 dS/m and 12, respectively);
For samples collected beneath the bridges that were analyzed for salinity (21HA16, 21HA17, 21HA19), EC values ranged from good to unsuitable. All SAR values were rated as unsuitable;
One sample (21HA28(0.6-0.8m)) had basic pH (9.39) exceeding AT1 Guidelines (6-8.5); and
All other analyzed parameters were less than the AT1 Guidelines.

Figure 1 shows the sampling locations and parameter exceedances. The laboratory analytical report is provided in Attachment 3.

6.4 Quality Assurance / Quality Control

Three duplicate field samples (DUP1, DUP2, and DUP3) were collected and compared to parent samples 21HA21 (0.0-0.3m), 21HA26 (0.6-1.0m), and 21HA09 (0.0-0.3m), respectively. The QA/QC RPD calculations are provided in Table 4. Parameters found outside the acceptable RPD tolerance of 50% are summarized in Table 6-2 below.

Table 6-2
Quality Assurance / Quality Control Summary

Table with 3 columns: Parent / Duplicate Sample, Parameter(s), and RPD. Row 1: 21HA09 (0.0-0.3m)/DUP3, Sulphate, 60%. Row 2: 21HA09 (0.0-0.3m)/DUP3, Cobalt, 51%. Row 3: 21HA09 (0.0-0.3m)/DUP3, Vanadium, 57%.

The differences in RPD value are interpreted to be reflective of sample heterogeneity. The QA/QC results indicate overall good accuracy and precision of all analytical data. Further information about the laboratory's QA/QC is provided in the laboratory report (Appendix C).



Memo To: Reg Ball, CIMA+
November 19, 2021
Page 10

6.5 Discussion

Soil EC values are influenced by salt ions including chloride, sodium, sulphate, and to lesser extent calcium, magnesium, and potassium. Chloride values throughout the project area ranged from 140 mg/kg (21HA04 (0.0-0.3m)) to 20,000 mg/kg (21HA19 (0.0-0.3m)). Chloride is the main component of road salt (sodium chloride and calcium chloride) and is a key indicator of anthropogenic activity. It is considered a COC since it is highly soluble, mobile in groundwater, and relatively stable and does not break down.

Sulphates can be naturally elevated in soils throughout the Edmonton region and can affect EC values. Concentrations within the Project Area ranged from 20 mg/kg (21HA09(0.0-0.3m)) to 1,800 mg/kg (21HA23(0.6-1.0m)). Although sulphate can influence EC, the reported elevated EC values within the Project Area are likely caused by the overall higher sodium and chloride concentrations. Therefore, sulphate is not a COC.

Sodium adsorption ratio is a calculated value based on a formula involving the ratio of sodium ions relative to magnesium and calcium ions within soils.

$$SAR = \frac{\text{Sodium}}{\sqrt{\left(\frac{\text{Calcium} + \text{Magnesium}}{2}\right)}}$$

Magnesium concentrations ranged from 1.1 mg/kg (21HA09(0.0-0.3m)) to 1,100 mg/kg (21HA19(0.0-0.3m)). Calcium concentrations range from 8.7 mg/kg (21HA09(0.0-0.3m)) to 2,800 mg/kg (21HA19(0.0-0.3m)). Sodium concentrations ranged from 160 mg/kg (multiple samples) to 10,000 mg/kg (21HA19 (0.0-0.3m)). Results displayed low concentrations of magnesium and low to moderate calcium concentrations relative to sodium. Elevated sodium concentrations within clay soils can alter soil structures making clays more platy and harder for water to permeate through causing vegetation growth impediments. Sodium is therefore considered a COC associated with road salt application. Although calcium is elevated, it does not impact soils or vegetation growth to the extent sodium and chloride does. Calcium is an indicator of road salt application when at elevated concentrations, however, calcium is not considered a COC.

There was one basic pH soil value reported at 21HA28 (0.6-0.8m) at 9.39. Overall the other pH values within the Project Area ranged from 7.32 to 8.24. The one pH exceedance is considered an anomalous result and not a concern for roadway and construction purposes.



Memo To: Reg Ball, CIMA+
November 19, 2021
Page 11

7 CONCLUSIONS

The Phase II ESA confirmed salt impacts in soil from ground surface to the maximum depth of investigation where salinity was tested (1.0 mbgs). Contaminants of concern include chloride and sodium.

Soils within the entire Project Area are considered to be impacted by historical road salt applications. Lateral and vertical delineation of salinity impacts was not achieved; however, delineation was not part of this Phase II ESA scope. Soil EC and SAR values are expected to decrease with depth from ground surface away from the source. The total depth extent of the salt impacts is unknown, but for the purposes of earthworks and construction, all soils from all depths should be considered as salt-impacted.

A Contaminated Soil Management Strategy (CSMS) is provided under a separate cover.

8 CLOSURE

This Phase II ESA memo was prepared for CIMA+ to identify contaminants of concern that may be encountered during project earthworks and construction along the 4.9 km segment of Whitemud Drive between Fox Drive and 122 Street.

The services provided by Associated Engineering Alberta Ltd. in the preparation of this report were conducted in a manner consistent with the level of skill ordinarily exercised by members of the profession currently practicing under similar conditions. No other warranty expressed or implied is made.

Respectfully submitted,
Associated Engineering Alberta Ltd.

Prepared by:

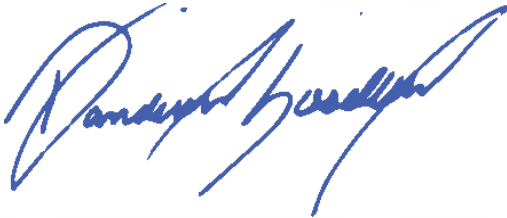

Danielle Loiselle, Geoscientist-In-Training
Environmental Scientist

Reviewed by:



November 19, 2021
Iot#102556

Brent Schmidt, P.Geo
Geoscientist



ASSOCIATED ENGINEERING ALBERTA LTD.

STANDARD DISCLAIMER FOR CONTAMINATED SITE INVESTIGATIONS, MONITORING AND CONFIRMATION OF
REMEDATION SERVICES

Subject to the following conditions and limitations, the investigation described in this report has been conducted by Associated Engineering Alberta Ltd. (Associated) for CIMA+ (the Client) in a manner consistent with a reasonable level of care and skill normally exercised by members of the environmental science profession currently practicing under similar conditions in the area.

1. The scope of the investigation described in this report has been limited by the budget set for the investigation in the work program. The scope of the investigation has been reasonable having regard to that budget constraint.
2. The investigation described in this report has been limited to the scope of work described in the work program.
3. The investigation described in this report has relied upon information provided by third parties concerning the history of the site. Except as stated in this report, we have not made an independent verification of such historical information.
4. The investigation described in this report has been made in the context of existing government regulations generally promulgated at the date of this report. Except as specifically noted, the investigation did not take account of any government regulations not in effect and generally promulgated at the date of this report.
5. All documents and drawings prepared by Associated, or by others on behalf of Associated, in connection with this Project are instruments of professional service for the execution of the Project. Associated retains the property and copyright in these documents and drawings, whether the Project is executed or not.
6. The findings and conclusions are valid only for the specific site identified in the report.
7. Since site conditions may change over time, the report is intended for immediate use.
8. This report is intended for the exclusive use of the Client, including all successors and assigns. The material in it reflects Associated's best judgement, in light of the information available to it, at the time of preparation. Any use that a third party makes of this report, or any reliance on or decisions to be made based on it, are the responsibility of such third parties. Associated accepts no responsibility for damages, if any, suffered by any third party as a result of decisions made or actions based on this report and makes no representation of fact or opinion of any nature whatsoever to any person or entity other than the Client.

In accepting delivery of this report, the Client hereby agrees that:

- A. Associated's liability for all claims of the Client, arising out of the agreement between Associated and the Client, pursuant to which this report has been prepared (the Agreement) shall absolutely cease to exist after a period of six (6) years from the date of:
 - i. substantial completion of the investigation described in this report,
 - ii. termination of Associated's Services under the Agreement,
 - iii. commencement of the limitation period for claims prescribed by any statute of the Province or Territory for the site of the investigation described in this report,
 - iv. any significant alteration of the site of the investigation described in this report, and/or neighbouring properties after the date of the final report that would change the conclusions and recommendations of the final report, whichever shall first occur, and following the expiration of such period, the Client shall have no claim whatsoever against Associated.
- B. Any and all claims that it may have against Associated's or any of its servants, agents, or employees arising out of or in any way connected with the investigation described in this report or the preparation of this report, whether such claims are in contract or in tort, and whether such claims are based on negligence or otherwise, shall be limited to a total amount equal to the fees payable to Associated's under the contract with the Client. Associated's shall bear no liability whatsoever for any consequential loss, injury or damage incurred by the Client including but not limited to claims for loss of profits and loss of markets.



**Associated
Engineering**

*GLOBAL PERSPECTIVE.
LOCAL FOCUS.*

TECHNICAL MEMORANDUM

FIGURE

https://aeris.ae.ca/DMS/view_document.aspx?ID=6412774&Latest=true

**A Carbon
Neutral
Company**



Platinum
member

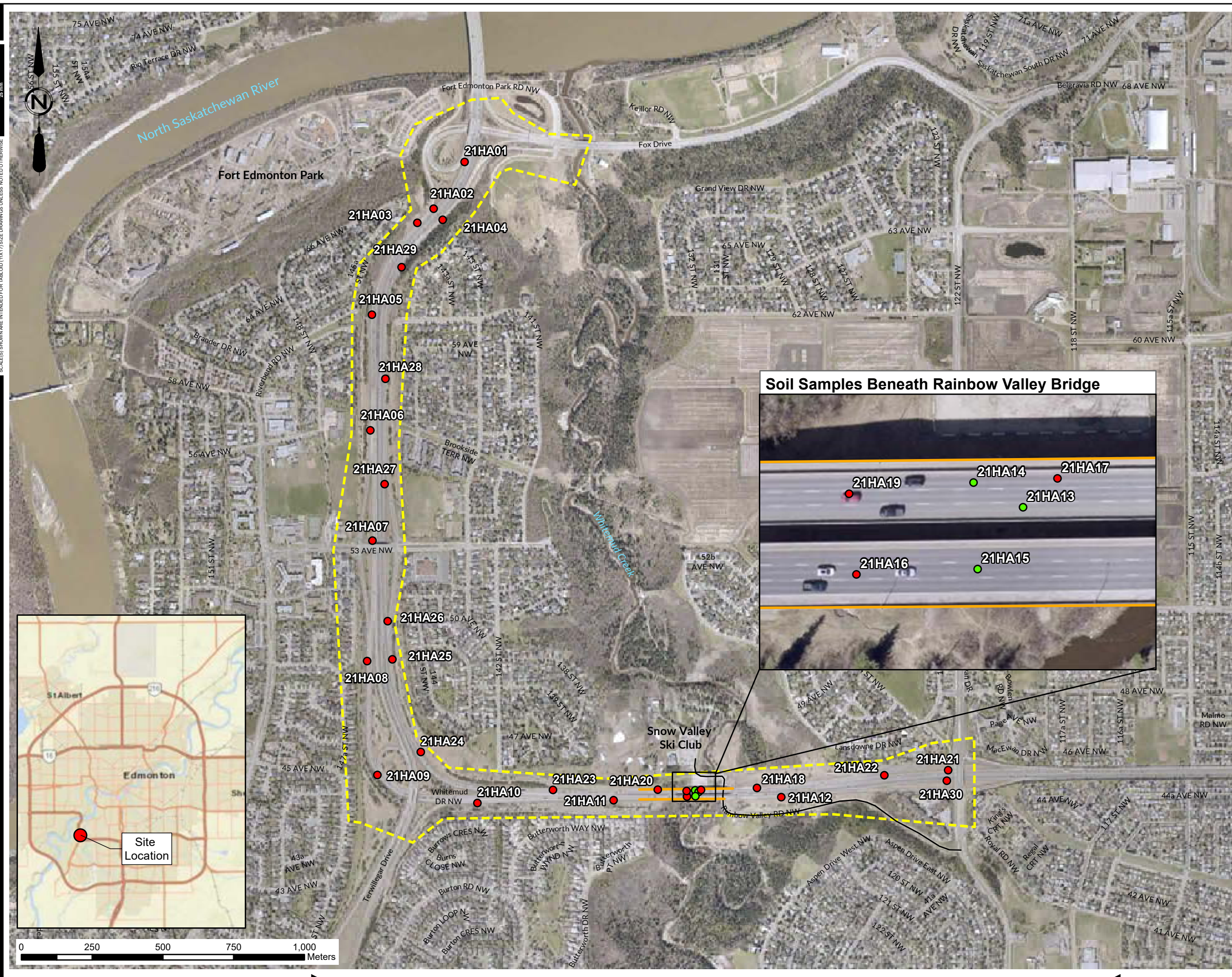

Legend

- Soil Sample Meets Regulatory Guidelines (PFAS only)
- Soil Sample Exceeds Regulatory Guidelines for EC and/or SAR
- Rainbow Valley Bridges
- Rainbow Valley Road
- Project Area

Notes:

All samples that were tested for BTEX, PHC fractions F1-F4, Metals and PAH met regulatory guidelines

pH exceedance only at 21HA28 (0.6-0.8m)

EC - electrical conductivity
SAR - sodium absorption ratio



FIGURE 1
TERWILLEGAR DRIVE STAGE 2 UPGRADES AND RAINBOW VALLEY BRIDGE RENEWAL AND WIDENING - PHASE II ESA
PROJECT AREA AND SOIL SAMPLING SUMMARY

AE PROJECT No.	2021-3981
SCALE	1:13,000
APPROVED DATE	2021JUL16
REV DESCRIPTION	ISSUED FOR MEMO

SAVE DATE: 7/14/2021 12:10:52 PM SAVED BY: [Name]
 DRAWING PATH: [Path]
 DATA SOURCE: 2019 Edmonton Ortho, 2019 Fort Sask Ortho, Soatize, 2017, City of Edmonton Environmental Sensitivities Project. Prepared for: City of Edmonton Parks & Biodiversity Edmonton, AB Sources: Esri, HERE, Garmin, USGS, Intermap, INCREMENT P, NRCan, Esri Japan, METI, Esri China (Hong Kong), Esri Korea, Esri (Thailand), NGCC, (c) OpenStreetMap contributors, and the GIS User Community.



TECHNICAL MEMORANDUM

TABLES

Table 1a. Soil Analytical Results - Salinity, Physical Parameters, and Metals - Commercial Guidelines
Project: 2021-3981

Sample Location		21HA01	21HA02	21HA03	21HA05	21HA06		21HA07		
Depth (m)		0.6-1.0	0.6-1.0	0.6-1.0	0.6-1.0	0.0-0.3	0.6-1.0	0.0-0.3		
Duplicates		-	-	-	-	-	-	-		
Date Sampled		2-Jun-21	3-Jun-21	3-Jun-21	3-Jun-21	3-Jun-21	3-Jun-21	3-Jun-21		
Lab ID		ZY0020	ZY0022	ZY0024	ZY0028	ZY0044	ZY0045	ZY0046		
Parameter	Units	AT1 Commercial Fine	Whitemud Drive Southbound Fox Drive to 53 Ave NW							
Salinity & Physical Parameters	pH (1:2 CaCl2)	pH units	6-8.5	7.61	7.65	7.70	7.93	7.72	7.66	7.86
	Conductivity (Sat. Paste)	dS/m	4	11	9.9	6.8	11	2.8	13	4.3
	Sodium Adsorption Ratio (SAR)	-	12	6.5	9.4	12	30	30	21	35
	Chloride	mg/kg	-	2000	1200	1500	1800	540	1700	420
	Calcium	mg/kg	-	770	430	230	160	22	440	15
	Magnesium	mg/kg	-	170	83	43	21	2.5	39	1.4
	Potassium	mg/kg	-	15	11	3.9	11	7.3	11	4.6
	Sodium	mg/kg	-	630	560	630	1100	400	1300	330
	Sulphate	mg/kg	-	1000	940	88	390	39	1600	75
	Saturation	%	-	68	47	70	57	52	59	37
	Moisture	%	-	24	12	24	20	16	20	4.3
	Soil Texture	NA	-	-	FINE	-	-	-	-	-
	Sieve - #200 (>0.075mm)	%	-	-	28	-	-	-	-	-
Metals	Antimony	mg/kg	40	<0.50	<0.50	<0.50	<0.50	<0.50	<0.50	<0.50
	Arsenic	mg/kg	26	10	7.4	8.1	7.0	6.0	9.4	5.2
	Barium	mg/kg	2000	220	180	220	180	180	200	130
	Beryllium	mg/kg	8	0.82	0.52	0.89	0.54	0.62	0.56	0.40
	Boron	mg/L	5.0	<0.10	<0.10	<0.10	<0.10	0.11	<0.10	0.16
	Cadmium	mg/kg	22	0.34	0.22	0.23	0.24	0.24	0.30	0.23
	Chromium	mg/kg	87	25	28	30	34	32	20	35
	Chromium (hexavalent)	mg/kg	1.4	<0.080	<0.080	<0.080	<0.080	<0.080	<0.080	<0.080
	Cobalt	mg/kg	300	12	9.1	12	8.6	11	9.3	7.6
	Copper	mg/kg	91	31	17	26	19	19	23	16
	Lead	mg/kg	260	13	9.8	14	12	19	11	22
	Mercury	mg/kg	24	0.057	<0.050	0.050	<0.050	<0.050	0.050	<0.050
	Molybdenum	mg/kg	40	1.3	1.1	1.0	1.2	1.1	1.1	1.2
	Nickel	mg/kg	89	34	28	34	31	29	26	27
	Selenium	mg/kg	2.9	<0.50	0.59	<0.50	<0.50	<0.50	0.73	<0.50
	Silver	mg/kg	40	<0.20	<0.20	<0.20	<0.20	<0.20	<0.20	<0.20
	Thallium	mg/kg	1	0.25	0.17	0.21	0.18	0.14	0.22	0.12
	Tin	mg/kg	300	<1.0	<1.0	<1.0	<1.0	1.0	<1.0	<1.0
Uranium	mg/kg	33	1.1	1.0	0.99	0.99	0.65	1.0	0.55	
Vanadium	mg/kg	130	35	28	42	28	35	29	26	
Zinc	mg/kg	410	91	62	77	64	86	79	68	

Notes:

AT1 - Alberta Environment and Parks (AEP). 2019. Alberta Tier 1 Soil and Groundwater Remediation Guidelines. Land Policy Branch, Policy and Planning Division. 198 pp (Commercial land use and Fine-grained surface soil criteria)

Shading indicates result exceeds AT1 Guidelines for Commercial Land Use

- Not analyzed/No Guideline



Table 1a. Soil Analytical Results - Salinity, Physical Parameters, and Metals - Commercial Guidelines
Project: 2021-3981

Sample Location		21HA08	21HA09			21HA10		21HA11	21HA12		21HA30	
Depth (m)		0.6-1.0	0.0-0.3			0.0-0.3	0.6-1.0	0.6-1.0	0.0-0.3	0.6-1.0	0.0-0.3	
Duplicates		-	-	DUP3		-	-	-	-	-	-	
Date Sampled		3-Jun-21	3-Jun-21	3-Jun-21	3-Jun-21	3-Jun-21	3-Jun-21	3-Jun-21	3-Jun-21	3-Jun-21	2-Jun-21	
Lab ID		ZY0049	ZY0050	ZY0096	ZY0052	ZY0053	ZY0055	ZY0056	ZY0057	ZY0092		
Parameter	Units	AT1 Commercial Fine	Whitemud Drive Southbound 53 Ave NW to Terwillager Drive Overpass			Whitemud Drive Eastbound Terwillager Drive to Rainbow Valley Bridge			Whitemud Drive Eastbound Rainbow Valley Bridge to 122 St NW			
Salinity & Physical Parameters	pH (1:2 CaCl2)	pH units	6-8.5	8.11	7.78	7.62	8.15	8.17	7.71	8.09	7.89	7.89
	Conductivity (Sat. Paste)	dS/m	4	8.4	2.7	2.2	6.3	4.8	11	14	9.5	2.5
	Sodium Adsorption Ratio (SAR)	-	12	37	27	23	50	30	14	64	50	22
	Chloride	mg/kg	-	1800	230	180	690	980	1800	2400	1200	330
	Calcium	mg/kg	-	63	12	8.7	16	37	460	73	43	21
	Magnesium	mg/kg	-	15	1.4	1.1	1.8	6.7	130	7.5	4.6	5.2
	Potassium	mg/kg	-	5.5	3.9	3.0	5.0	4.2	22	13	6.8	10
	Sodium	mg/kg	-	1000	220	160	490	620	1100	1600	850	330
	Sulphate	mg/kg	-	77	37	20	36	130	1500	57	93	57
	Saturation	%	-	65	38	36	38	70	67	54	43	60
	Moisture	%	-	27	20	19	9.9	25	21	15	18	23
	Soil Texture	NA	-	-	-	-	-	-	FINE	-	COARSE	-
	Sieve - #200 (>0.075mm)	%	-	-	-	-	-	-	7.1	-	56	-
	Metals	Antimony	mg/kg	40	<0.50	<0.50	0.52	<0.50	<0.50	0.52	<0.50	<0.50
Arsenic		mg/kg	26	12	5.9	4.0	5.1	7.6	5.8	5.8	5.8	6.1
Barium		mg/kg	2000	210	180	110	140	210	280	140	180	150
Beryllium		mg/kg	8	0.64	0.60	<0.40	0.48	0.69	0.77	0.51	0.40	0.58
Boron		mg/L	5.0	<0.10	0.12	0.10	0.15	<0.10	<0.10	0.19	0.10	0.20
Cadmium		mg/kg	22	0.41	0.25	0.18	0.18	0.25	0.32	0.26	0.22	0.30
Chromium		mg/kg	87	22	44	32	38	28	23	42	17	38
Chromium (hexavalent)		mg/kg	1.4	<0.080	<0.080	<0.080	<0.080	<0.080	<0.080	<0.080	<0.080	<0.080
Cobalt		mg/kg	300	12	9.4	5.6	7.3	11	12	7.7	7.6	8.4
Copper		mg/kg	91	29	20	17	16	23	35	22	13	22
Lead		mg/kg	260	14	15	18	15	12	12	31	7.4	17
Mercury		mg/kg	24	0.094	<0.050	<0.050	<0.050	<0.050	0.051	<0.050	<0.050	<0.050
Molybdenum		mg/kg	40	1.3	1.3	1.3	1.3	1.2	1.0	1.6	0.78	1.2
Nickel		mg/kg	89	33	34	21	28	32	34	29	20	30
Selenium		mg/kg	2.9	2.9	<0.50	<0.50	<0.50	<0.50	<0.50	<0.50	<0.50	0.59
Silver		mg/kg	40	<0.20	<0.20	<0.20	<0.20	<0.20	<0.20	<0.20	<0.20	<0.20
Thallium		mg/kg	1	0.24	0.16	<0.10	0.15	0.21	0.28	0.13	0.20	0.14
Tin		mg/kg	300	<1.0	<1.0	<1.0	<1.0	<1.0	<1.0	1.1	<1.0	<1.0
Uranium		mg/kg	33	1.1	0.74	0.51	0.63	1.0	1.9	1.1	0.92	1.4
Vanadium		mg/kg	130	35	34	19	28	39	26	29	20	31
Zinc	mg/kg	410	98	92	81	67	73	74	82	47	82	

Notes:

AT1 - Alberta Environment and Parks (AEP). 2019. Alberta Tier 1 Soil and Groundwater Remediation Guidelines. Land Policy Branch, Policy and Planning Division. 198 pp (Commercial land use and Fine-grained surface soil criteria)

Shading indicates result exceeds AT1 Guidelines for Commercial Land Use

- Not analyzed/No Guideline



Table 1a. Soil Analytical Results - Salinity, Physical Parameters, and Metals - Commercial Guidelines
Project: 2021-3981

Sample Location		21HA21	21HA22	21HA18	21HA20	21HA23	21HA24			
Depth (m)		0.0-0.3	0.0-0.3	0.6-1.0	0.0-0.3	0.6-1.0	0.6-1.0			
Duplicates		-	DUP1	-	-	-	-			
Date Sampled		2-Jun-21	2-Jun-21	2-Jun-21	3-Jun-21	3-Jun-21	2-Jun-21	2-Jun-21		
Lab ID		ZY0074	ZY0094	ZY0076	ZY0069	ZY0072	ZY0079	ZY0081		
Parameter	Units	AT1 Commercial Fine	Whitemud Drive Westbound 122 St NW to Rainbow Valley Bridge				Whitemud Drive Westbound Rainbow Valley Bridge to Terwillegar Drive			
			Salinity & Physical Parameters	pH (1:2 CaCl2)	pH units	6-8.5	8.09	8.01	8.13	7.79
Conductivity (Sat. Paste)	dS/m	4		5.3	4.6	5.1	13	15	9.7	12
Sodium Adsorption Ratio (SAR)	-	12		28	27	36	19	58	21	30
Chloride	mg/kg	-		1100	820	780	3100	2700	750	2300
Calcium	mg/kg	-		55	39	30	350	100	290	170
Magnesium	mg/kg	-		9.6	6.3	4.1	120	16	27	33
Potassium	mg/kg	-		7.7	6.0	5.5	13	9.5	11	7.7
Sodium	mg/kg	-		690	550	580	1400	1800	1000	1300
Sulphate	mg/kg	-		84	62	69	110	98	1800	98
Saturation	%	-		67	63	53	71	57	54	61
Moisture	%	-		18	21	21	19	23	23	22
Soil Texture	NA	-		-	-	-	-	-	-	FINE
Sieve - #200 (>0.075mm)	%	-		-	-	-	-	-	-	30
Metals	Antimony	mg/kg		40	<0.50	<0.50	<0.50	<0.50	0.83	<0.50
	Arsenic	mg/kg	26	8.5	6.4	6.3	9.5	5.2	7.9	8.3
	Barium	mg/kg	2000	200	170	160	220	160	220	200
	Beryllium	mg/kg	8	0.74	0.56	0.55	0.72	0.56	0.44	0.72
	Boron	mg/L	5.0	0.12	0.14	0.17	<0.10	0.20	<0.10	<0.10
	Cadmium	mg/kg	22	0.29	0.27	0.22	0.34	0.25	0.34	0.21
	Chromium	mg/kg	87	35	29	26	26	44	19	76
	Chromium (hexavalent)	mg/kg	1.4	<0.080	<0.080	<0.080	<0.080	<0.080	<0.080	<0.080
	Cobalt	mg/kg	300	9.9	8.5	8.1	11	7.4	9.1	9.3
	Copper	mg/kg	91	23	22	17	29	21	19	22
	Lead	mg/kg	260	13	13	12	13	19	11	11
	Mercury	mg/kg	24	<0.050	<0.050	<0.050	<0.050	<0.050	<0.050	0.061
	Molybdenum	mg/kg	40	1.2	1.1	0.99	1.2	1.6	1.1	2.2
	Nickel	mg/kg	89	32	27	25	35	29	25	50
	Selenium	mg/kg	2.9	0.58	<0.50	<0.50	<0.50	0.51	0.55	<0.50
	Silver	mg/kg	40	<0.20	<0.20	<0.20	<0.20	<0.20	<0.20	<0.20
	Thallium	mg/kg	1	0.20	0.17	0.14	0.22	0.13	0.22	0.18
	Tin	mg/kg	300	<1.0	<1.0	<1.0	<1.0	<1.0	<1.0	<1.0
Uranium	mg/kg	33	2.0	1.9	1.7	1.2	1.8	1.2	0.96	
Vanadium	mg/kg	130	35	31	30	33	29	27	32	
Zinc	mg/kg	410	80	76	70	84	83	75	63	

Notes:

AT1 - Alberta Environment and Parks (AEP). 2019. Alberta Tier 1 Soil and Groundwater Remediation Guidelines. Land Policy Branch, Policy and Planning Division. 198 pp (Commercial land use and Fine-grained surface soil criteria)

Shading indicates result exceeds AT1 Guidelines for Commercial Land Use

- Not analyzed/No Guideline



Table 1a. Soil Analytical Results - Salinity, Physical Parameters, and Metals - Commercial Guidelines
Project: 2021-3981

Sample Location		21HA25	21HA26		21HA27		21HA28	21HA29	21HA04		
Depth (m)		0.6-1.0	0.6-1.0		0.0-0.3	0.6-1.0	0.6-0.8	0.6-1.0	0.0-0.3		
Duplicates		-	-	DUP2	-	-	-	-	-		
Date Sampled		2-Jun-21	2-Jun-21	2-Jun-21	2-Jun-21	2-Jun-21	2-Jun-21	2-Jun-21	2-Jun-21		
Lab ID		ZY0083	ZY0085	ZY0095	ZY0086	ZY0087	ZY0089	ZY0091	ZY0025		
Parameter	Units	AT1 Commercial Fine	Whitemud Drive Northbound Terwillegar Drive to 53 Ave NW			Whitemud Drive Northbound 53 Ave NW to Fox Drive					
			Salinity & Physical Parameters	pH (1:2 CaCl2)	pH units	6-8.5	7.66	7.52	7.53	8.24	7.97
Conductivity (Sat. Paste)	dS/m	4		12	14	15	4.5	7.4	11	2.1	1.6
Sodium Adsorption Ratio (SAR)	-	12		15	16	15	39	28	36	13	16
Chloride	mg/kg	-		3000	3100	3900	820	1600	1400	340	140
Calcium	mg/kg	-		380	490	620	22	110	99	31	14
Magnesium	mg/kg	-		150	140	160	2.2	18	2.5	6.3	1.8
Potassium	mg/kg	-		10	12	19	7.6	6.1	7.2	3.1	1.7
Sodium	mg/kg	-		1200	1200	1400	580	1000	890	250	160
Sulphate	mg/kg	-		69	130	160	46	190	260	100	42
Saturation	%	-		74	63	77	65	78	45	66	46
Moisture	%	-		27	26	27	12	22	21	31	22
Soil Texture	NA	-		-	-	-	FINE	-	-	-	FINE
Sieve - #200 (>0.075mm)	%	-		-	-	-	25	-	-	-	17
Metals	Antimony	mg/kg		40	<0.50	<0.50	<0.50	<0.50	<0.50	<0.50	<0.50
	Arsenic	mg/kg	26	8.4	7.7	9.9	5.8	8.8	6.5	7.9	5.5
	Barium	mg/kg	2000	220	200	240	180	210	180	200	170
	Beryllium	mg/kg	8	0.67	0.68	0.87	0.62	0.77	<0.40	0.73	0.59
	Boron	mg/L	5.0	<0.10	<0.10	<0.10	0.15	<0.10	0.12	<0.10	<0.10
	Cadmium	mg/kg	22	0.31	0.25	0.40	0.32	0.24	0.29	0.20	0.17
	Chromium	mg/kg	87	23	22	30	28	28	26	73	60
	Chromium (hexavalent)	mg/kg	1.4	<0.080	<0.080	<0.080	<0.080	<0.080	<0.080	<0.080	<0.080
	Cobalt	mg/kg	300	10	10	12	8.6	12	7.9	11	8.7
	Copper	mg/kg	91	28	29	29	22	27	13	25	17
	Lead	mg/kg	260	13	12	14	22	15	9.9	15	10
	Mercury	mg/kg	24	<0.050	<0.050	<0.050	<0.050	<0.050	<0.050	<0.050	<0.050
	Molybdenum	mg/kg	40	1.1	0.99	1.1	1.2	1.1	1.2	2.1	1.6
	Nickel	mg/kg	89	28	27	34	26	35	25	52	41
	Selenium	mg/kg	2.9	<0.50	0.81	0.92	<0.50	<0.50	<0.50	<0.50	<0.50
	Silver	mg/kg	40	<0.20	<0.20	<0.20	<0.20	<0.20	<0.20	<0.20	<0.20
	Thallium	mg/kg	1	0.22	0.19	0.29	0.14	0.21	0.16	0.19	0.12
	Tin	mg/kg	300	<1.0	<1.0	<1.0	<1.0	<1.0	<1.0	<1.0	<1.0
Uranium	mg/kg	33	1.1	1.3	1.4	0.61	1.1	0.94	0.88	1.2	
Vanadium	mg/kg	130	33	33	45	29	39	22	35	30	
Zinc	mg/kg	410	81	84	92	85	81	53	72	63	

Notes:

AT1 - Alberta Environment and Parks (AEP). 2019. Alberta Tier 1 Soil and Groundwater Remediation Guidelines. Land Policy Branch, Policy and Planning Division. 198 pp (Commercial land use and Fine-grained surface soil criteria)

Shading indicates result exceeds AT1 Guidelines for Commercial Land Use

- Not analyzed/No Guideline



Project: 2021-3981

Sample Location		21HA16		21HA17		21HA19			
Depth (m)		0.0-0.3	0.6-1.0	0.0-0.3	0.6-1.0	0.0-0.3	0.6-1.0		
Duplicates		-	-	-	-	-	-		
Date Sampled		4-Jun-21	4-Jun-21	4-Jun-21	4-Jun-21	4-Jun-21	4-Jun-21		
Lab ID		ZY0064	ZY0065	ZY0066	ZY0067	ZY0070	ZY0071		
Parameter	Units	AT1 Residential/Parkland Fine	Rainbow Valley Bridge						
Salinity & Physical Parameters	pH (1:2 CaCl2)	pH units	6-8.5	7.86	7.86	7.61	7.84	7.32	7.85
	Conductivity (Sat. Paste)	dS/m	See ratings table	6.4	2.8	7.0	4.5	100	7.5
	Sodium Adsorption Ratio (SAR)	-	See ratings table	23	14	17	17	60	14
	Chloride	mg/kg	-	1200	470	1400	940	20000	1300
	Calcium	mg/kg	-	77	38	150	74	2800	250
	Magnesium	mg/kg	-	17	9.9	29	16	1100	59
	Potassium	mg/kg	-	19	8.6	5.0	9.0	190	22
	Sodium	mg/kg	-	660	310	680	510	10000	820
	Sulphate	mg/kg	-	35	72	42	50	1400	670
	Saturation	%	-	61	64	62	68	48	71
	Moisture	%	-	16	19	23	19	19	21
	Soil Texture	NA	-	-	-	-	-	-	-
	Sieve - #200 (>0.075mm)	%	-	-	-	-	-	-	-
	Metals	Antimony	mg/kg	20	<0.50	<0.50	<0.50	<0.50	<0.50
Arsenic		mg/kg	17	9.2	13	6.4	7.6	5.4	8.5
Barium		mg/kg	500	180	210	190	220	150	210
Beryllium		mg/kg	5	0.55	0.62	0.61	0.73	0.55	0.70
Boron		mg/L	3.3	<0.10	<0.10	<0.10	<0.10	0.31	<0.10
Cadmium		mg/kg	10	0.26	0.28	0.33	0.27	0.26	0.33
Chromium		mg/kg	64	31	20	29	27	39	21
Chromium (hexavalent)		mg/kg	0.4	<0.080	<0.080	<0.080	<0.080	<0.080	<0.080
Cobalt		mg/kg	20	9.6	10	8.3	9.5	8.1	9.7
Copper		mg/kg	63	20	20	18	21	29	25
Lead		mg/kg	140	19	9.8	11	13	27	13
Mercury		mg/kg	6.6	<0.050	<0.050	<0.050	<0.050	<0.050	<0.050
Molybdenum		mg/kg	4	1.2	1.2	0.89	1.2	1.5	1.2
Nickel		mg/kg	45	27	27	27	28	26	26
Selenium		mg/kg	1	<0.50	<0.50	0.53	<0.50	0.80	<0.50
Silver		mg/kg	20	<0.20	<0.20	0.71	<0.20	<0.20	<0.20
Thallium		mg/kg	1	0.17	0.18	0.15	0.18	0.13	0.25
Tin		mg/kg	5	<1.0	<1.0	<1.0	<1.0	<1.0	<1.0
Uranium		mg/kg	23	1.3	1.5	1.5	1.5	1.1	1.9
Vanadium		mg/kg	130	28	24	30	24	34	25
Zinc	mg/kg	250	77	68	65	67	100	67	

Notes:

AT1 - Alberta Environment and Parks (AEP). 2019. Alberta Tier 1 Soil and Groundwater Remediation Guidelines. Land Policy Branch, Policy and Planning Division. 198 pp (Residential/Parkland land use and Fine-grained surface soil criteria)

Shading indicates result exceeds AT1 Guidelines for Residential/Parkland Land Use

- Not analyzed/No Guideline

AT1 Table 4: Alberta Tier 1 Salt Remediation Guidelines

Rating Category	Good	Fair	Poor	Unsuitable
Topsoil (0.0-0.3 m)				
Conductivity dS/m	<2	2 to 4	4 to 8	>8
SAR	<4	4 to 8	8 to 12	>12
Subsoil (>0.3 m)				
Conductivity dS/m	<3	3 to 5	5 to 10	>10
SAR	<4	4 to 8	8 to 12	>12

Table 2a. Soil Analytical Results - Petroleum Hydrocarbons, Polycyclic Aromatic Hydrocarbons - Commercial Guidelines
Project: 2021-3981

			Sample Location	21HA01	21HA02	21HA03	21HA05	21HA06	21HA07
			Depth (m)	0.0-0.3	0.0-0.3	0.0-0.3	0.0-0.3	0.0-0.3	0.6-1.0
			Duplicates	-	-	-	-	-	-
			Date Sampled	2-Jun-21	3-Jun-21	3-Jun-21	3-Jun-21	3-Jun-21	3-Jun-21
			Lab ID	ZY0019	ZY0021	ZY0023	ZY0027	ZY0044	ZY0047
Parameter	Units	AT1 Commercial Fine	Whitemud Drive Southbound Fox Drive to 53 Ave NW						
			Petroleum Hydrocarbons						
Benzene	mg/kg	0.046	<0.0050	<0.0050	<0.0050	<0.0050	<0.0050	<0.0050	<0.0050
Toluene	mg/kg	0.52	<0.050	<0.050	<0.050	<0.050	<0.050	<0.050	<0.050
Ethylbenzene	mg/kg	0.073	<0.010	<0.010	<0.010	<0.010	<0.010	<0.010	<0.010
Total Xylenes	mg/kg	0.99	<0.045	<0.045	<0.045	<0.045	<0.045	<0.045	<0.045
F1-BTEX	mg/kg	320	<10	<10	<10	<10	<10	<10	<10
Fraction 2 (C11-C16)	mg/kg	260	<10	<10	<10	<10	<10	<10	<10
Fraction 3 (C16-C34)	mg/kg	2,500	51	<50	<50	67	72	<50	<50
Fraction 4 (C34-C50)	mg/kg	6,600	<50	<50	<50	68	<50	<50	<50
Fraction 4G - SG	mg/kg	-	-	-	-	-	-	-	-
Chrom. To baseline at nC50	-	-	Yes	Yes	Yes	Yes	Yes	Yes	Yes
Polycyclic Aromatic Hydrocarbons									
Non-Carcinogenic PAH									
Acenaphthene	mg/kg	0.33	<0.0050	-	-	-	-	-	<0.0050
Acenaphthylene	mg/kg	-	<0.0050	-	-	-	-	-	<0.0050
Anthracene	mg/kg	1.3	<0.0040	-	-	-	-	-	<0.0040
Fluoranthene	mg/kg	180	<0.0050	-	-	-	-	-	<0.0050
Fluorene	mg/kg	0.40	<0.0050	-	-	-	-	-	<0.0050
Naphthalene	mg/kg	0.014	<0.0050	-	-	-	-	-	<0.0050
Phenanthrene	mg/kg	0.11	<0.0050	-	-	-	-	-	<0.0050
Pyrene	mg/kg	3,200	<0.0050	-	-	-	-	-	<0.0050
Carcinogenic PAH									
Benzo(a)anthracene	mg/kg	-	<0.0050	-	-	-	-	-	<0.0050
Benzo(a)pyrene	mg/kg	72	<0.0050	-	-	-	-	-	<0.0050
Benzo(b+j)fluoranthene	mg/kg	-	<0.0050	-	-	-	-	-	<0.0050
Benzo(g,h,i)perylene	mg/kg	-	<0.0050	-	-	-	-	-	<0.0050
Benzo(k)fluoranthene	mg/kg	-	<0.0050	-	-	-	-	-	<0.0050
Chrysene	mg/kg	-	<0.0050	-	-	-	-	-	<0.0050
Dibenzo(a,h)anthracene	mg/kg	-	<0.0050	-	-	-	-	-	<0.0050
Indeno(1,2,3-c,d)pyrene	mg/kg	-	<0.0050	-	-	-	-	-	<0.0050
IACR Coarse	mg/kg	1.0	<0.10	-	-	-	-	-	<0.10
IACR Fine	mg/kg	1.0	<0.10	-	-	-	-	-	<0.10
B(a)P Total Potency Equivalents	mg/kg	8.0	<0.0071	-	-	-	-	-	<0.0071

Notes:

AT1 - Alberta Environment and Parks (AEP). 2019. Alberta Tier 1 Soil and Groundwater Remediation Guidelines. Land Policy Branch, Policy and Planning Division. 198 pp (Commercial land use and Fine-grained surface soil criteria)

Shading indicates result exceeds AT1 Guidelines for Commercial Land Use

- Not analyzed/No Guideline

Table 2a. Soil Analytical Results - Petroleum Hydrocarbons, Polycyclic Aromatic Hydrocarbons - Commercial Guidelines
Project: 2021-3981

		Sample Location	21HA08	21HA09		21HA10	21HA11	21HA12	21HA30
		Depth (m)	0.0-0.3	0.0-0.3		0.0-0.3	0.0-0.3	0.0-0.3	0.6-1.0
		Duplicates	-	-	DUP3	-	-	-	-
		Date Sampled	3-Jun-21	3-Jun-21	2-Jun-21	3-Jun-21	3-Jun-21	3-Jun-21	2-Jun-21
		Lab ID	ZY0048	ZY0050	ZY0096	ZY0052	ZY0054	ZY0056	ZY0093
Parameter	Units	AT1 Commercial Fine	Whitemud Drive Southbound 53 Ave NW to Terwillager Drive Overpass			Whitemud Drive Eastbound Terwillager Drive to Rainbow Valley Bridge		Whitemud Drive Eastbound Rainbow Valley Bridge to 122 St NW	
			Petroleum Hydrocarbons						
Benzene	mg/kg	0.046	<0.0050	<0.0050	<0.0050	<0.0050	<0.0050	<0.0050	<0.0050
Toluene	mg/kg	0.52	<0.050	<0.050	<0.050	<0.050	<0.050	<0.050	<0.050
Ethylbenzene	mg/kg	0.073	<0.010	<0.010	<0.010	<0.010	<0.010	<0.010	<0.010
Total Xylenes	mg/kg	0.99	<0.045	<0.045	<0.045	<0.045	<0.045	<0.045	<0.045
F1-BTEX	mg/kg	320	<10	<10	<10	<10	<10	<10	<10
Fraction 2 (C11-C16)	mg/kg	260	<10	<10	<10	<10	<10	<10	<10
Fraction 3 (C16-C34)	mg/kg	2,500	61	82	62	180	110	120	<50
Fraction 4 (C34-C50)	mg/kg	6,600	<50	58	<50	200	54	78	<50
Fraction 4G - SG	mg/kg	-	-	-	-	-	-	-	-
Chrom. To baseline at nC50	-	-	Yes	Yes	Yes	Yes	Yes	Yes	Yes
Non-Carcinogenic PAH									
Acenaphthene	mg/kg	0.33	<0.0050	<0.0050	<0.0050	-	<0.0050	-	-
Acenaphthylene	mg/kg	-	<0.0050	<0.0050	<0.0050	-	<0.0050	-	-
Anthracene	mg/kg	1.3	<0.0040	<0.0040	<0.0040	-	<0.0040	-	-
Fluoranthene	mg/kg	180	0.037	<0.0050	<0.0050	-	<0.0050	-	-
Fluorene	mg/kg	0.40	<0.0050	<0.0050	<0.0050	-	<0.0050	-	-
Naphthalene	mg/kg	0.014	<0.0050	<0.0050	<0.0050	-	<0.0050	-	-
Phenanthrene	mg/kg	0.11	0.019	<0.0050	<0.0050	-	<0.0050	-	-
Pyrene	mg/kg	3,200	0.033	0.0062	<0.0050	-	0.020	-	-
Carcinogenic PAH									
Benzo(a)anthracene	mg/kg	-	0.014	<0.0050	<0.0050	-	<0.0050	-	-
Benzo(a)pyrene	mg/kg	72	0.015	<0.0050	<0.0050	-	<0.0050	-	-
Benzo(b+j)fluoranthene	mg/kg	-	0.021	0.0065	<0.0050	-	0.012	-	-
Benzo(g,h,i)perylene	mg/kg	-	0.011	0.0080	<0.0050	-	0.0063	-	-
Benzo(k)fluoranthene	mg/kg	-	0.0063	<0.0050	<0.0050	-	<0.0050	-	-
Chrysene	mg/kg	-	0.012	<0.0050	<0.0050	-	<0.0050	-	-
Dibenzo(a,h)anthracene	mg/kg	-	<0.0050	<0.0050	<0.0050	-	<0.0050	-	-
Indeno(1,2,3-c,d)pyrene	mg/kg	-	0.0094	<0.0050	<0.0050	-	<0.0050	-	-
IACR Coarse	mg/kg	1.0	<0.10	<0.10	<0.10	-	<0.10	-	-
IACR Fine	mg/kg	1.0	<0.10	<0.10	<0.10	-	<0.10	-	-
B(a)P Total Potency Equivalents	mg/kg	8.0	0.023	<0.0071	<0.0071	-	<0.0071	-	-

Notes:

AT1 - Alberta Environment and Parks (AEP). 2019. Alberta Tier 1 Soil and Groundwater Remediation Guidelines. Land Policy Branch, Policy and Planning Division. 198 pp (Commercial land use and Fine-grained surface soil criteria)

Shading indicates result exceeds AT1 Guidelines for Commercial Land Use

- Not analyzed/No Guideline

Table 2a. Soil Analytical Results - Petroleum Hydrocarbons, Polycyclic Aromatic Hydrocarbons - Commercial Guidelines
Project: 2021-3981

		Sample Location	21HA21	21HA22	21HA18	21HA20	21HA23	21HA24	
		Depth (m)	0.0-0.3	0.0-0.3	0.0-0.3	0.6-1.0	0.0-0.3	0.0-0.3	
		Duplicates	-	DUP1	-	-	-	-	
		Date Sampled	2-Jun-21	2-Jun-21	2-Jun-21	3-Jun-21	3-Jun-21	2-Jun-21	
		Lab ID	ZY0074	ZY0094	ZY0076	ZY0068	ZY0073	ZY0078	
Parameter	Units	AT1 Commercial Fine	Whitemud Drive Westbound 122 St NW to Rainbow Valley Bridge				Whitemud Drive Westbound Rainbow Valley Bridge to Terwillegar Drive		
			Petroleum Hydrocarbons						
Benzene	mg/kg	0.046	<0.0050	<0.0050	<0.0050	<0.0050	<0.0050	<0.0050	<0.0050
Toluene	mg/kg	0.52	<0.050	<0.050	<0.050	<0.050	<0.050	<0.050	<0.050
Ethylbenzene	mg/kg	0.073	<0.010	<0.010	<0.010	<0.010	<0.010	<0.010	<0.010
Total Xylenes	mg/kg	0.99	<0.045	<0.045	<0.045	<0.045	<0.045	<0.045	<0.045
F1-BTEX	mg/kg	320	<10	<10	<10	<10	<10	<10	<10
Fraction 2 (C11-C16)	mg/kg	260	<10	<10	<10	<10	<10	<10	<10
Fraction 3 (C16-C34)	mg/kg	2,500	78	<50	67	76	91	<50	450
Fraction 4 (C34-C50)	mg/kg	6,600	62	<50	<50	<50	62	<50	760
Fraction 4G - SG	mg/kg	-	-	-	-	-	-	-	4300
Chrom. To baseline at nC50	-	-	Yes	Yes	Yes	Yes	Yes	Yes	No
Non-Carcinogenic PAH									
Acenaphthene	mg/kg	0.33	-	-	<0.0050	<0.0050	-	-	-
Acenaphthylene	mg/kg	-	-	-	<0.0050	<0.0050	-	-	-
Anthracene	mg/kg	1.3	-	-	<0.0040	<0.0040	-	-	-
Fluoranthene	mg/kg	180	-	-	<0.0050	0.0079	-	-	-
Fluorene	mg/kg	0.40	-	-	<0.0050	<0.0050	-	-	-
Naphthalene	mg/kg	0.014	-	-	<0.0050	<0.0050	-	-	-
Phenanthrene	mg/kg	0.11	-	-	<0.0050	0.0088	-	-	-
Pyrene	mg/kg	3,200	-	-	<0.0050	0.0072	-	-	-
Carcinogenic PAH									
Benzo(a)anthracene	mg/kg	-	-	-	<0.0050	<0.0050	-	-	-
Benzo(a)pyrene	mg/kg	72	-	-	<0.0050	<0.0050	-	-	-
Benzo(b+j)fluoranthene	mg/kg	-	-	-	<0.0050	<0.0050	-	-	-
Benzo(g,h,i)perylene	mg/kg	-	-	-	<0.0050	<0.0050	-	-	-
Benzo(k)fluoranthene	mg/kg	-	-	-	<0.0050	<0.0050	-	-	-
Chrysene	mg/kg	-	-	-	<0.0050	<0.0050	-	-	-
Dibenzo(a,h)anthracene	mg/kg	-	-	-	<0.0050	<0.0050	-	-	-
Indeno(1,2,3-c,d)pyrene	mg/kg	-	-	-	<0.0050	<0.0050	-	-	-
IACR Coarse	mg/kg	1.0	-	-	<0.10	<0.10	-	-	-
IACR Fine	mg/kg	1.0	-	-	<0.10	<0.10	-	-	-
B(a)P Total Potency Equivalents	mg/kg	8.0	-	-	<0.0071	<0.0071	-	-	-

Notes:

AT1 - Alberta Environment and Parks (AEP). 2019. Alberta Tier 1 Soil and Groundwater Remediation Guidelines. Land Policy Branch, Policy and Planning Division. 198 pp (Commercial land use and Fine-grained surface soil criteria)

Shading indicates result exceeds AT1 Guidelines for Commercial Land Use

- Not analyzed/No Guideline

Table 2a. Soil Analytical Results - Petroleum Hydrocarbons, Polycyclic Aromatic Hydrocarbons - Commercial Guidelines
Project: 2021-3981

		Sample Location	21HA25	21HA26		21HA27	21HA28	21HA29	21HA04
		Depth (m)	0.0-0.3	0.6-1.0		0.6-1.0	0.0-0.3	0.0-0.3	0.6-1.0
		Duplicates	-	-	DUP2	-	-	-	-
		Date Sampled	2-Jun-21	2-Jun-21	2-Jun-21	2-Jun-21	2-Jun-21	2-Jun-21	2-Jun-21
		Lab ID	ZY0082	ZY0085	ZY0095	ZY0086	ZY0088	ZY0090	ZY0026
Parameter	Units	AT1 Commercial Fine	Whitemud Drive Northbound Terwillegar Drive to 53 Ave NW			Whitemud Drive Northbound 53 Ave NW to Fox Drive			
			Petroleum Hydrocarbons						
Benzene	mg/kg	0.046	<0.0050	<0.0050	<0.0050	<0.0050	<0.0050	<0.0050	<0.0050
Toluene	mg/kg	0.52	<0.050	<0.050	<0.050	<0.050	<0.050	<0.050	<0.050
Ethylbenzene	mg/kg	0.073	<0.010	<0.010	<0.010	<0.010	<0.010	<0.010	<0.010
Total Xylenes	mg/kg	0.99	<0.045	<0.045	<0.045	<0.045	<0.045	<0.045	<0.045
F1-BTEX	mg/kg	320	<10	<10	<10	<10	<10	<10	<10
Fraction 2 (C11-C16)	mg/kg	260	<10	<10	<10	<10	<10	<10	<10
Fraction 3 (C16-C34)	mg/kg	2,500	83	68	82	<50	150	100	68
Fraction 4 (C34-C50)	mg/kg	6,600	56	<50	<50	<50	130	63	<50
Fraction 4G - SG	mg/kg	-	-	-	-	-	-	-	-
Chrom. To baseline at nC50	-	-	Yes	Yes	Yes	Yes	Yes	Yes	Yes
Non-Carcinogenic PAH									
Acenaphthene	mg/kg	0.33	<0.0050	-	-	-	-	<0.0050	<0.0050
Acenaphthylene	mg/kg	-	<0.0050	-	-	-	-	<0.0050	<0.0050
Anthracene	mg/kg	1.3	<0.0040	-	-	-	-	<0.0040	<0.0040
Fluoranthene	mg/kg	180	<0.0050	-	-	-	-	<0.0050	<0.0050
Fluorene	mg/kg	0.40	<0.0050	-	-	-	-	<0.0050	<0.0050
Naphthalene	mg/kg	0.014	<0.0050	-	-	-	-	<0.0050	<0.0050
Phenanthrene	mg/kg	0.11	<0.0050	-	-	-	-	<0.0050	<0.0050
Pyrene	mg/kg	3,200	<0.0050	-	-	-	-	<0.0050	0.021
Carcinogenic PAH									
Benzo(a)anthracene	mg/kg	-	<0.0050	-	-	-	-	<0.0050	<0.0050
Benzo(a)pyrene	mg/kg	72	<0.0050	-	-	-	-	<0.0050	0.0073
Benzo(b+j)fluoranthene	mg/kg	-	<0.0050	-	-	-	-	<0.0050	0.011
Benzo(g,h,i)perylene	mg/kg	-	<0.0050	-	-	-	-	<0.0050	<0.0050
Benzo(k)fluoranthene	mg/kg	-	<0.0050	-	-	-	-	<0.0050	<0.0050
Chrysene	mg/kg	-	<0.0050	-	-	-	-	<0.0050	<0.0050
Dibenzo(a,h)anthracene	mg/kg	-	<0.0050	-	-	-	-	<0.0050	<0.0050
Indeno(1,2,3-c,d)pyrene	mg/kg	-	<0.0050	-	-	-	-	<0.0050	<0.0050
IACR Coarse	mg/kg	1.0	<0.10	-	-	-	-	<0.10	<0.10
IACR Fine	mg/kg	1.0	<0.10	-	-	-	-	<0.10	<0.10
B(a)P Total Potency Equivalents	mg/kg	8.0	<0.0071	-	-	-	-	<0.0071	0.012

Notes:

AT1 - Alberta Environment and Parks (AEP). 2019. Alberta Tier 1 Soil and Groundwater Remediation Guidelines. Land Policy Branch, Policy and Planning Division. 198 pp (Commercial land use and Fine-grained surface soil criteria)

Shading indicates result exceeds AT1 Guidelines for Commercial Land Use

- Not analyzed/No Guideline

Project: 2021-3981

Parameter		Units	AT1 Residential/Parkland Fine	Rainbow Valley Bridge		
Petroleum Hydrocarbons	Benzene	mg/kg	0.046	<0.0050	<0.0050	<0.0050
	Toluene	mg/kg	0.52	<0.050	<0.050	<0.050
	Ethylbenzene	mg/kg	0.073	<0.010	<0.010	<0.010
	Total Xylenes	mg/kg	0.99	<0.045	<0.045	<0.045
	F1-BTEX	mg/kg	210	<10	<10	<10
	Fraction 2 (C11-C16)	mg/kg	150	<10	<10	<10
	Fraction 3 (C16-C34)	mg/kg	1,300	63	73	97
	Fraction 4 (C34-C50)	mg/kg	5,600	<50	<50	58
	Fraction 4G - SG	mg/kg	-	-	-	-
	Chrom. To baseline at nC50	-	-	Yes	Yes	Yes

Notes:

Guideline - Alberta Environment and Parks (AEP). 2019. Alberta Tier 1 Soil and Groundwater Remediation Guidelines. Land Policy Branch, Policy and Planning Division. 198 pp (Residential/Parkland land use and Fine-grained surface soil criteria)

Shading indicates result exceeds AT1 Guidelines for Residential/Parkland Land Use

- Not analyzed/No Guideline



Table 3. Soil Analytical Results - Per- and Polyfluoroalkyls Substances
Project: 2021-3981

		Sample Location	21HA13	21HA14	21HA15			
		Depth (m)	1.0-1.3	1.0-1.3	1.0-1.3			
		Duplicates	-	-	-			
		Date Sampled	4-Jun-21	4-Jun-21	4-Jun-21			
		Lab ID	ZY0059	ZY0061	ZY0063			
Parameter	Units	Guideline Residential/Parkland						
		BC CSR	CCME	Health Canada				
Perfluoroalkylated Compounds	Perfluorobutanoic acid (PFBA)	mg/kg	-	-	114	<0.001	<0.001	<0.001
	Perfluoropentanoic Acid (PFPeA)	mg/kg	-	-	0.8	<0.001	<0.001	<0.001
	Perfluorohexanoic Acid (PFHxA)	mg/kg	-	-	0.8	<0.001	<0.001	<0.001
	Perfluoroheptanoic Acid (PFHpA)	mg/kg	-	-	0.8	<0.001	<0.001	<0.001
	Perfluorooctanoic Acid (PFOA)	mg/kg	-	-	0.7	<0.001	<0.001	0.0011
	Perfluorononanoic Acid (PFNA)	mg/kg	-	-	0.08	<0.001	<0.001	<0.001
	Perfluorodecanoic Acid (PFDA)	mg/kg	-	-	-	<0.001	<0.001	<0.001
	Perfluoroundecanoic Acid (PFUnA)	mg/kg	-	-	-	<0.001	<0.001	<0.001
	Perfluorododecanoic Acid (PFDoA)	mg/kg	-	-	-	<0.001	<0.001	<0.001
	Perfluorotridecanoic Acid	mg/kg	-	-	-	<0.001	<0.001	<0.001
	Perfluorotetradecanoic Acid	mg/kg	-	-	-	<0.001	<0.001	<0.001
	Perfluorobutanesulfonic acid	mg/kg	-	-	-	<0.001	<0.001	<0.001
	Perfluoropentanesulfonic acid	mg/kg	-	-	-	<0.001	<0.001	<0.001
	Perfluorohexanesulfonic acid	mg/kg	-	-	-	<0.001	<0.001	<0.001
	Perfluoroheptanesulfonic acid	mg/kg	-	-	-	<0.001	<0.001	<0.001
	Perfluorooctanesulfonic acid (PFOS)	mg/kg	0.35	0.01	2.1	<0.001	<0.001	<0.001
	Perfluorononane sulfonic acid	mg/kg	-	-	-	<0.001	<0.001	<0.001
	Perfluorodecanesulfonic acid (PFDS)	mg/kg	-	-	-	<0.001	<0.001	<0.001
Perfluorooctane Sulfonamide (PFOSA)	mg/kg	-	-	-	<0.001	<0.001	<0.001	

Notes:

BC CSR (RL_D) - British Columbia (BC) Contaminated Sites Regulation (CSR), Schedule 3.3. Generic Numerical Soil Standards (BC Reg. 375/96) (Low Density Residential Land Use)

CCME - Canadian Council of Ministers of the Environment. Canadian Environmental Quality Guidelines: Soil Quality Guidelines for the Protection of Environmental and Human Health. Final Proposed Federal Soil Quality Guideline. Residential/Parkland land use for fine-grained surface soils.

Health Canada - Updates to Health Canada Soil Screening Values for Perfluoroalkylated Substances (PFAS).

- Not analyzed/No Guideline

			21HA21 (0.0-0.3m)	DUP1	Relative Percent Difference (%)	
Date Sampled			2-Jun-21			
Parameter	Units	LDL				
Salinity & Physical Parameters	pH (1:2 CaCl ₂)	pH units	0.10	8.09	8.01	1
	Conductivity (Sat. Paste)	dS/m	0.020	5.3	4.6	14
	Sodium Adsorption Ratio (SAR)	-	0.10	28	27	4
	Chloride	mg/kg	7.1	1100	820	29
	Calcium	mg/kg	0.5	55	39	34
	Magnesium	mg/kg	0.36	9.6	6.3	42
	Potassium	mg/kg	0.46	7.7	6.0	25
	Sodium	mg/kg	0.89	690	550	23
	Sulphate	mg/kg	1.8	84	62	30
	Saturation	%	-	67	63	6
	Moisture	%	0.30	18	21	15
Metals	Antimony	mg/kg	0.50	<0.50	<0.50	-
	Arsenic	mg/kg	1.0	8.5	6.4	28
	Barium	mg/kg	1.0	200	170	16
	Beryllium	mg/kg	0.40	0.74	0.56	-
	Boron	mg/L	0.10	0.12	0.14	-
	Cadmium	mg/kg	0.050	0.29	0.27	7
	Chromium	mg/kg	1.0	35	29	19
	Chromium (hexavalent)	mg/kg	0.080	<0.080	<0.080	-
	Cobalt	mg/kg	0.50	9.9	8.5	15
	Copper	mg/kg	1.0	23	22	4
	Lead	mg/kg	0.50	13	13	0
	Mercury	mg/kg	0.050	<0.050	<0.050	-
	Molybdenum	mg/kg	0.40	1.2	1.1	-
	Nickel	mg/kg	1.0	32	27	17
	Selenium	mg/kg	0.50	0.58	<0.50	-
	Silver	mg/kg	0.20	<0.20	<0.20	-
	Thallium	mg/kg	0.10	0.20	0.17	-
	Tin	mg/kg	1.0	<1.0	<1.0	-
Uranium	mg/kg	0.20	2.0	1.9	5	
Vanadium	mg/kg	1.0	35	31	12	
Zinc	mg/kg	10	80	76	5	
Petroleum Hydrocarbons	Benzene	mg/kg	0.0050	<0.0050	<0.0050	-
	Toluene	mg/kg	0.050	<0.050	<0.050	-
	Ethylbenzene	mg/kg	0.010	<0.010	<0.010	-
	Total Xylenes	mg/kg	0.045	<0.045	<0.045	-
	F1-BTEX	mg/kg	10	<10	<10	-
	Fraction 2 (C11-C16)	mg/kg	10	<10	<10	-
	Fraction 3 (C16-C34)	mg/kg	50	78	<50	-
	Fraction 4 (C34-C50)	mg/kg	50	62	<50	-
Non-Carcinogenic PAH	Acenaphthene	mg/kg	0.0050	-	-	-
	Acenaphthylene	mg/kg	0.0050	-	-	-
	Anthracene	mg/kg	0.0040	-	-	-
	Fluoranthene	mg/kg	0.0050	-	-	-
	Fluorene	mg/kg	0.0050	-	-	-
	Naphthalene	mg/kg	0.0050	-	-	-
	Phenanthrene	mg/kg	0.0050	-	-	-
	Pyrene	mg/kg	0.0050	-	-	-
Carcinogenic PAH	Benzo(a)anthracene	mg/kg	0.0050	-	-	-
	Benzo(a)pyrene	mg/kg	0.0050	-	-	-
	Benzo(b+j)fluoranthene	mg/kg	0.0050	-	-	-
	Benzo(g,h,i)perylene	mg/kg	0.0050	-	-	-
	Benzo(k)fluoranthene	mg/kg	0.0050	-	-	-
	Chrysene	mg/kg	0.0050	-	-	-
	Dibenzo(a,h)anthracene	mg/kg	0.0050	-	-	-
	Indeno(1,2,3-c,d)pyrene	mg/kg	0.0050	-	-	-

Notes:

- Not analyzed / Result not 5x more than LDL

Shading indicates RPD values greater than 50%

LDL - Lowest Detection Limit

* Individual analyte detection limit reported to be greater than overall LDL

			21HA26 (0.6-1.0m)	DUP2	Relative Percent Difference (%)	
Date Sampled			2-Jun-21			
Parameter	Units	LDL				
Salinity & Physical Parameters	pH (1:2 CaCl2)	pH units	0.10	7.52	7.53	0
	Conductivity (Sat. Paste)	dS/m	0.020	14	15	7
	Sodium Adsorption Ratio (SAR)	-	0.10	16	15	6
	Chloride	mg/kg	7.1	3100	3900	23
	Calcium	mg/kg	0.5	490	620	23
	Magnesium	mg/kg	0.36	140	160	13
	Potassium	mg/kg	0.46	12	19	45
	Sodium	mg/kg	0.89	1200	1400	15
	Sulphate	mg/kg	1.8	130	160	21
	Saturation	%	-	63	77	20
	Moisture	%	0.30	26	27	4
Metals	Antimony	mg/kg	0.50	<0.50	<0.50	-
	Arsenic	mg/kg	1.0	7.7	9.9	25
	Barium	mg/kg	1.0	200	240	18
	Beryllium	mg/kg	0.40	0.68	0.87	-
	Boron	mg/L	0.10	<0.10	<0.10	-
	Cadmium	mg/kg	0.050	0.25	0.40	-
	Chromium	mg/kg	1.0	22	30	31
	Chromium (hexavalent)	mg/kg	0.080	<0.080	<0.080	-
	Cobalt	mg/kg	0.50	10	12	18
	Copper	mg/kg	1.0	29	29	0
	Lead	mg/kg	0.50	12	14	15
	Mercury	mg/kg	0.050	<0.050	<0.050	-
	Molybdenum	mg/kg	0.40	0.99	1.1	-
	Nickel	mg/kg	1.0	27	34	23
	Selenium	mg/kg	0.50	0.81	0.92	-
	Silver	mg/kg	0.20	<0.20	<0.20	-
	Thallium	mg/kg	0.10	0.19	0.29	-
	Tin	mg/kg	1.0	<1.0	<1.0	-
Uranium	mg/kg	0.20	1.3	1.4	7	
Vanadium	mg/kg	1.0	33	45	31	
Zinc	mg/kg	10	84	92	9	
Petroleum Hydrocarbons	Benzene	mg/kg	0.0050	<0.0050	<0.0050	-
	Toluene	mg/kg	0.050	<0.050	<0.050	-
	Ethylbenzene	mg/kg	0.010	<0.010	<0.010	-
	Total Xylenes	mg/kg	0.045	<0.045	<0.045	-
	F1-BTEX	mg/kg	10	<10	<10	-
	Fraction 2 (C11-C16)	mg/kg	10	<10	<10	-
	Fraction 3 (C16-C34)	mg/kg	50	68	82	-
Fraction 4 (C34-C50)	mg/kg	50	<50	<50	-	
Non-Carcinogenic PAH	Acenaphthene	mg/kg	0.0050	-	-	-
	Acenaphthylene	mg/kg	0.0050	-	-	-
	Anthracene	mg/kg	0.0040	-	-	-
	Fluoranthene	mg/kg	0.0050	-	-	-
	Fluorene	mg/kg	0.0050	-	-	-
	Naphthalene	mg/kg	0.0050	-	-	-
	Phenanthrene	mg/kg	0.0050	-	-	-
	Pyrene	mg/kg	0.0050	-	-	-
Carcinogenic PAH	Benzo(a)anthracene	mg/kg	0.0050	-	-	-
	Benzo(a)pyrene	mg/kg	0.0050	-	-	-
	Benzo(b+j)fluoranthene	mg/kg	0.0050	-	-	-
	Benzo(g,h,i)perylene	mg/kg	0.0050	-	-	-
	Benzo(k)fluoranthene	mg/kg	0.0050	-	-	-
	Chrysene	mg/kg	0.0050	-	-	-
	Dibenzo(a,h)anthracene	mg/kg	0.0050	-	-	-
	Indeno(1,2,3-c,d)pyrene	mg/kg	0.0050	-	-	-

Notes:

- Not analyzed / Result not 5x more than LDL

Shading indicates RPD values greater than 50%

LDL - Lowest Detection Limit

* Individual analyte detection limit reported to be greater than overall LD

			21HA09 (0.0-0.3m)	DUP3	Relative Percent Difference (%)	
Date Sampled			3-Jun-21			
Parameter	Units	LDL				
Salinity & Physical Parameters	pH (1:2 CaCl2)	pH units	0.10	7.78	7.62	2
	Conductivity (Sat. Paste)	dS/m	0.020	2.7	2.2	20
	Sodium Adsorption Ratio (SAR)	-	0.10	27	23	16
	Chloride	mg/kg	7.1	230	180	24
	Calcium	mg/kg	0.5	12	8.7	32
	Magnesium	mg/kg	0.36	1.4	1.1	-
	Potassium	mg/kg	0.46	3.9	3.0	26
	Sodium	mg/kg	0.89	220	160	32
	Sulphate	mg/kg	1.8	37	20	60
	Saturation	%	-	38	36	5
	Moisture	%	0.30	20	19	5
Metals	Antimony	mg/kg	0.50	<0.50	0.52	-
	Arsenic	mg/kg	1.0	5.9	4.0	-
	Barium	mg/kg	1.0	180	110	48
	Beryllium	mg/kg	0.40	0.60	<0.40	-
	Boron	mg/L	0.10	0.12	0.10	-
	Cadmium	mg/kg	0.050	0.25	0.18	-
	Chromium	mg/kg	1.0	44	32	32
	Chromium (hexavalent)	mg/kg	0.080	<0.080	<0.080	-
	Cobalt	mg/kg	0.50	9.4	5.6	51
	Copper	mg/kg	1.0	20	17	16
	Lead	mg/kg	0.50	15	18	18
	Mercury	mg/kg	0.050	<0.050	<0.050	-
	Molybdenum	mg/kg	0.40	1.3	1.3	-
	Nickel	mg/kg	1.0	34	21	47
	Selenium	mg/kg	0.50	<0.50	<0.50	-
	Silver	mg/kg	0.20	<0.20	<0.20	-
	Thallium	mg/kg	0.10	0.16	<0.10	-
	Tin	mg/kg	1.0	<1.0	<1.0	-
Uranium	mg/kg	0.20	0.74	0.51	-	
Vanadium	mg/kg	1.0	34	19	57	
Zinc	mg/kg	10	92	81	13	
Petroleum Hydrocarbons	Benzene	mg/kg	0.0050	<0.0050	<0.0050	-
	Toluene	mg/kg	0.050	<0.050	<0.050	-
	Ethylbenzene	mg/kg	0.010	<0.010	<0.010	-
	Total Xylenes	mg/kg	0.045	<0.045	<0.045	-
	F1-BTEX	mg/kg	10	<10	<10	-
	Fraction 2 (C11-C16)	mg/kg	10	<10	<10	-
	Fraction 3 (C16-C34)	mg/kg	50	82	62	-
	Fraction 4 (C34-C50)	mg/kg	50	58	<50	-
Non-Carcinogenic PAH	Acenaphthene	mg/kg	0.0050	<0.0050	<0.0050	-
	Acenaphthylene	mg/kg	0.0050	<0.0050	<0.0050	-
	Anthracene	mg/kg	0.0040	<0.0040	<0.0040	-
	Fluoranthene	mg/kg	0.0050	<0.0050	<0.0050	-
	Fluorene	mg/kg	0.0050	<0.0050	<0.0050	-
	Naphthalene	mg/kg	0.0050	<0.0050	<0.0050	-
	Phenanthrene	mg/kg	0.0050	<0.0050	<0.0050	-
	Pyrene	mg/kg	0.0050	0.0062	<0.0050	-
Carcinogenic PAH	Benzo(a)anthracene	mg/kg	0.0050	<0.0050	<0.0050	-
	Benzo(a)pyrene	mg/kg	0.0050	<0.0050	<0.0050	-
	Benzo(b+j)fluoranthene	mg/kg	0.0050	0.0065	<0.0050	-
	Benzo(g,h,i)perylene	mg/kg	0.0050	0.0080	<0.0050	-
	Benzo(k)fluoranthene	mg/kg	0.0050	<0.0050	<0.0050	-
	Chrysene	mg/kg	0.0050	<0.0050	<0.0050	-
	Dibenzo(a,h)anthracene	mg/kg	0.0050	<0.0050	<0.0050	-
	Indeno(1,2,3-c,d)pyrene	mg/kg	0.0050	<0.0050	<0.0050	-

Notes:

- Not analyzed / Result not 5x more than LDL

Shading indicates RPD values greater than 50%

LDL - Lowest Detection Limit

* Individual analyte detection limit reported to be greater than overall LD





TECHNICAL MEMORANDUM

APPENDIX A – TEST HOLE LOGS

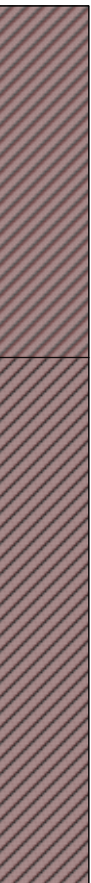
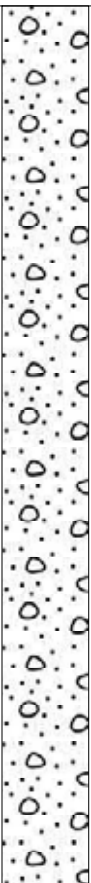

Project Details			Borehole ID		Location		
Project Number:	2021-3981		21HA01		Northing (m):	5931255	
Client:	CIMA+				Easting (m):	329730	
Location:	Whitemud Drive, Edmonton				Elevation (masl):	638	
Subsurface Profile			Sample	PID Reading (PPM)	Electrical Conductivity (mS/cm)	Well Completion	
Depth (m)	Graphic Log	Description	I.D.	0 1 2 3 4 5	0 5 10	Well Construction	Details

0		CLAY, silty, sandy, blackish brown, dry, slightly friable	0.0-0.3m	● 0	2.10 X		Backfilled with hand auger cuttings
0.1							
0.2							
0.3							
0.4	0.40 m	CLAY, silty, brown, slightly moist, soft, slightly sticky, mottled					
0.5							
0.6							
0.7							
0.8			0.6-1.0m	● 1	5.02 X		
0.9							
1	1.00 m						
1.1		1.0 m - End of Hole					
1.2							
1.3							
1.4							

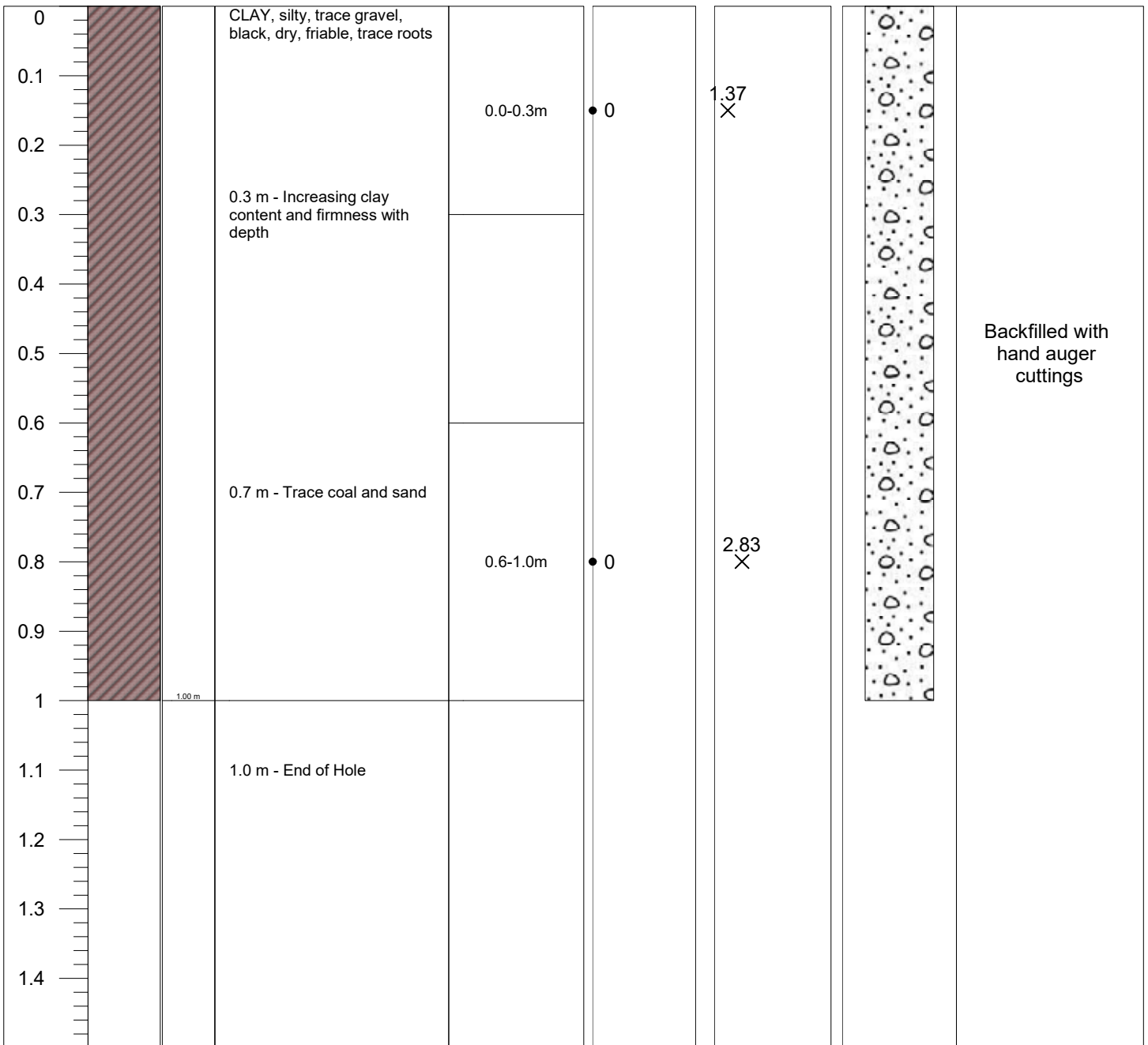

	Lithology Legend  CL	Contractor:
		Date of construction: 2 / Jun / 2021 Drilling method: Hand auger Logged by: DL Drawn by: Danielle L. Reviewed by: Brent S.





Project Details			Borehole ID		Location		
Project Number:	2021-3981		21HA02		Northing (m):	5931094	
Client:	CIMA+				Easting (m):	329614	
Location:	Whitemud Drive, Edmonton				Elevation (masl):	645	
Subsurface Profile			Sample	PID Reading (PPM)	Electrical Conductivity (mS/cm)	Well Completion	
Depth (m)	Graphic Log	Description	I.D.	0 1 2 3 4 5	0 5 10	Well Construction	Details

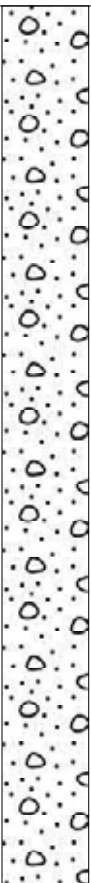

	Lithology Legend  CL	Contractor:
		Date of construction: 3 / Jun / 2021 Drilling method: Hand auger Logged by: DL Drawn by: Danielle L. Reviewed by: Brent S.



Project Details			Borehole ID		Location		
Project Number:	2021-3981		21HA03		Northing (m):	5931047	
Client:	CIMA+				Easting (m):	329554	
Location:	Whitemud Drive, Edmonton				Elevation (masl):	648	
Subsurface Profile			Sample	PID Reading (PPM)	Electrical Conductivity (mS/cm)	Well Completion	
Depth (m)	Graphic Log	Description	I.D.	0 1 2 3 4 5	0 5 10	Well Construction	Details

0		CLAY, trace sand and silt, brown, dry to moist, slightly plastic	0.0-0.3m	● 0	2.67 X		Backfilled with hand auger cuttings
0.1							
0.2							
0.3	0.30 m						
0.4		SAND, clayey, brown, moist, slightly friable					
0.5	0.50 m						
0.6		CLAY, sandy, brown moist, soft, slightly plastic, trace oxides					
0.7							
0.8		0.8 m - Slightly firm	0.6-1.0m	● 0	3.60 X		
0.9							
1	1.00 m						
1.1		1.0 m - End of Hole					
1.2							
1.3							
1.4							

	Lithology Legend  SW  ML  CL	Contractor:
		Date of construction: 3 / Jun / 2021 Drilling method: Hand auger Logged by: DL Drawn by: Danielle L. Reviewed by: Brent S.

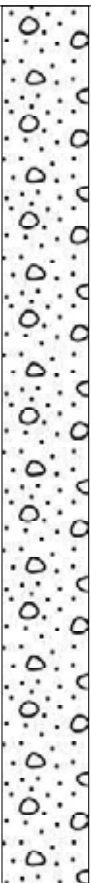

Project Details			Borehole ID		Location		
Project Number:	2021-3981		21HA04		Northing (m):	5931054	
Client:	CIMA+				Easting (m):	329644	
Location:	Whitemud Drive, Edmonton				Elevation (masl):	638	
Subsurface Profile			Sample	PID Reading (PPM)	Electrical Conductivity (mS/cm)	Well Completion	
Depth (m)	Graphic Log	Description	I.D.	0 1 2 3 4 5	0 5 10	Well Construction	Details

0		MIXED SAND/SILT/CLAY, trace gravel, blackish brown, friable	0.0-0.3m	● 0	1.38 X		Backfilled with hand auger cuttings
0.1							
0.2							
0.3							
0.4	0.40 m	SAND AND CLAY, trace silt and gravel, black, wet, slightly sticky, increasing clay and firmness with depth					
0.5							
0.6							
0.7							
0.8			0.6-1.0m	● 0	0.87 X		
0.9							
1	1.00 m	1.0 m - End of Hole					
1.1							
1.2							
1.3							
1.4							

	Lithology Legend  SW	Contractor:
		Date of construction: 2 / Jun / 2021 Drilling method: Hand auger Logged by: DL Drawn by: Danielle L. Reviewed by: Brent S.

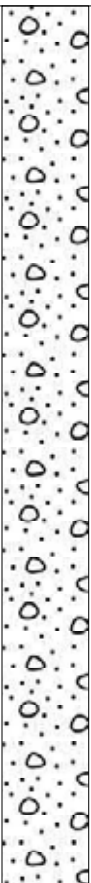

Project Details			Borehole ID		Location		
Project Number:	2021-3981		21HA05		Northing (m):	5930729	
Client:	CIMA+				Easting (m):	329380	
Location:	Whitemud Drive, Edmonton				Elevation (masl):	659	
Subsurface Profile			Sample	PID Reading (PPM)	Electrical Conductivity (mS/cm)	Well Completion	
Depth (m)	Graphic Log	Description	I.D.	0 1 2 3 4 5	0 5 10	Well Construction	Details

0		CLAY, sandy, trace silt, brown, dry to moist, slightly soft	0.0-0.3m	● 0	1.24 X		Backfilled with hand auger cuttings
0.1							
0.2							
0.3							
0.4							
0.5							
0.6		0.6 m - Dry to moist, trace gravel, white precipitates					
0.7							
0.8			0.6-1.0m	● 0	6.30 X		
0.9							
1							
1.1		1.0 m - End of Hole					
1.2							
1.3							
1.4							

	Lithology Legend  ML	Contractor:
		Date of construction: 3 / Jun / 2021 Drilling method: Hand auger Logged by: DL Drawn by: Danielle L. Reviewed by: Brent S.

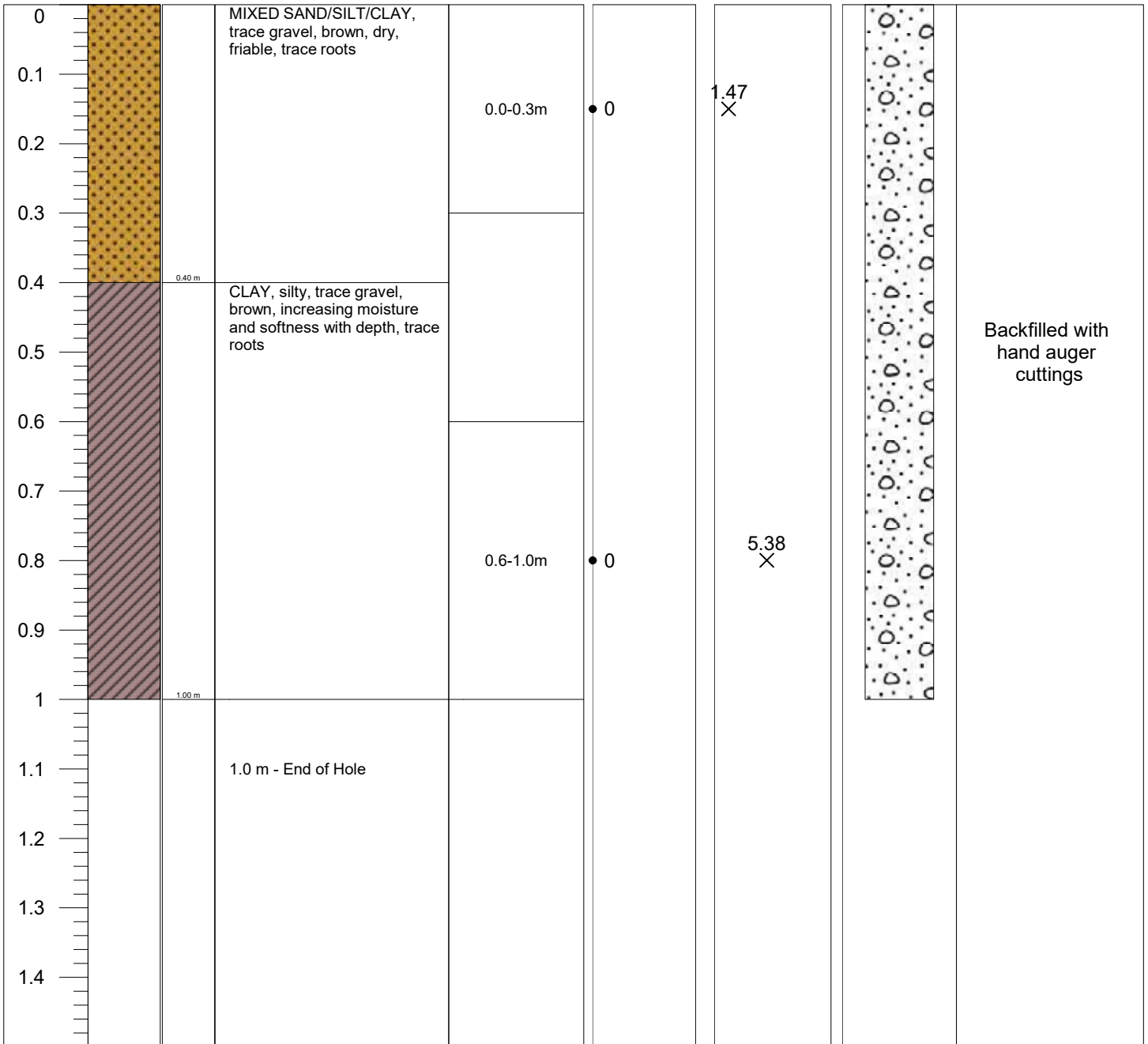

Project Details			Borehole ID		Location		
Project Number:	2021-3981		21HA06		Northing (m):	5930321	
Client:	CIMA+				Easting (m):	329357	
Location:	Whitemud Drive, Edmonton				Elevation (masl):	661	
Subsurface Profile			Sample	PID Reading (PPM)	Electrical Conductivity (mS/cm)	Well Completion	
Depth (m)	Graphic Log	Description	I.D.	0 1 2 3 4 5	0 5 10	Well Construction	Details



	Lithology Legend  SW  CL	Contractor:
		Date of construction: 3 / Jun / 2021 Drilling method: Hand auger Logged by: DL Drawn by: Danielle L. Reviewed by: Brent S.

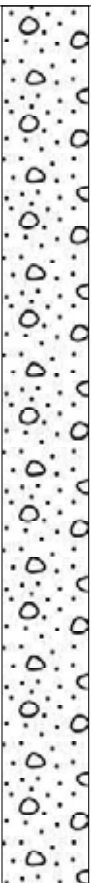

Project Details			Borehole ID		Location		
Project Number:	2021-3981		21HA07		Northing (m):	5929931	
Client:	CIMA+				Easting (m):	329349	
Location:	Whitemud Drive, Edmonton				Elevation (masl):	664	
Subsurface Profile			Sample	PID Reading (PPM)	Electrical Conductivity (mS/cm)	Well Completion	
Depth (m)	Graphic Log	Description	I.D.	0 1 2 3 4 5	0 5 10	Well Construction	Details

0		MIXED SAND/SILT/CLAY, trace gravel, brown, dry, friable, trace roots	0.0-0.3m	● 0	1.94 X		Backfilled with hand auger cuttings
0.1							
0.2							
0.3	0.30 m	SAND, clayey, brown, dry to moist, increasing clay content with depth					
0.4							
0.5							
0.6							
0.7							
0.8			0.6-1.0m	● 0	0.44 X		
0.9							
1	1.00 m	1.0 m - End of Hole					
1.1							
1.2							
1.3							
1.4							

	Lithology Legend  SW	Contractor:
		Date of construction: 3 / Jun / 2021 Drilling method: Hand auger Logged by: DL Drawn by: Danielle L. Reviewed by: Brent S.

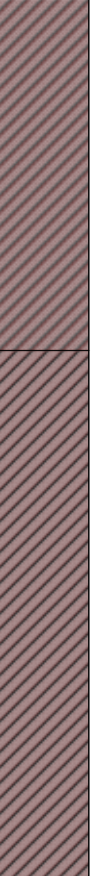
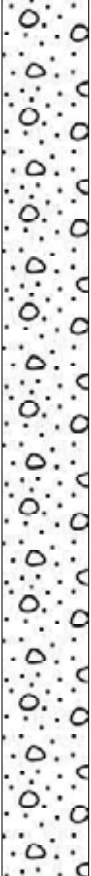

Project Details			Borehole ID		Location		
Project Number:	2021-3981		21HA08		Northing (m):	5929507	
Client:	CIMA+				Easting (m):	329312	
Location:	Whitemud Drive, Edmonton				Elevation (masl):	666	
Subsurface Profile			Sample	PID Reading (PPM)	Electrical Conductivity (mS/cm)	Well Completion	
Depth (m)	Graphic Log	Description	I.D.	0 1 2 3 4 5	0 5 10	Well Construction	Details

0		CLAY AND SILT, sandy, blackish brown, dry, slightly friable, trace roots	0.0-0.3m	● 0	1.73 X		Backfilled with hand auger cuttings
0.1							
0.2							
0.3							
0.4	0.40 m	CLAY, silty, moist, soft, slightly sticky					
0.5							
0.6							
0.7							
0.8			0.6-1.0m	● 0	4.46 X		
0.9							
1	1.00 m	1.0 m - End of Hole					
1.1							
1.2							
1.3							
1.4							

	Lithology Legend  CL	Contractor:
		Date of construction: 3 / Jun / 2021 Drilling method: Hand auger Logged by: DL Drawn by: Danielle L. Reviewed by: Brent S.

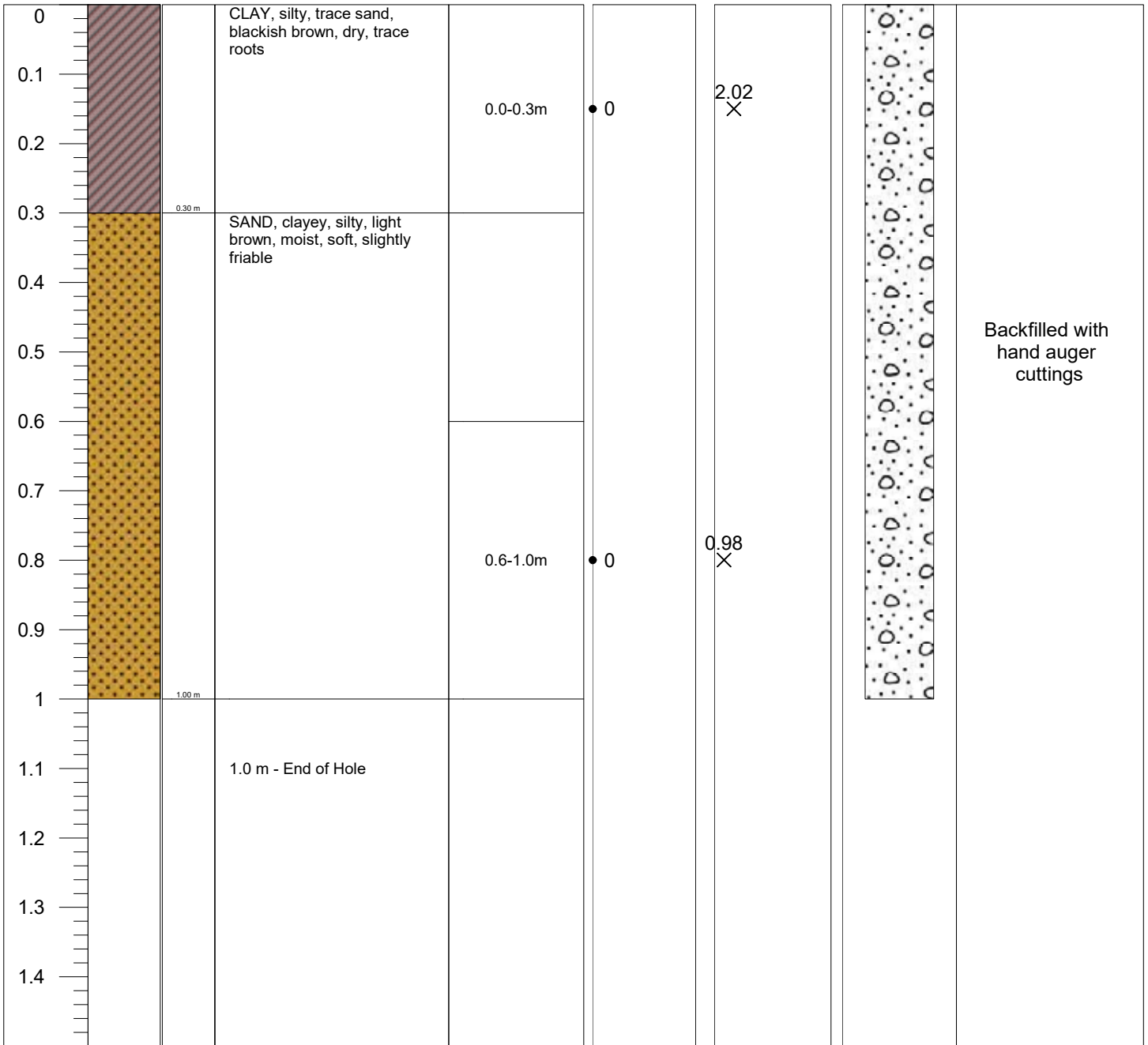

Project Details			Borehole ID		Location		
Project Number:	2021-3981		21HA09		Northing (m):	5929103	
Client:	CIMA+				Easting (m):	329331	
Location:	Whitemud Drive, Edmonton				Elevation (masl):	667	
Subsurface Profile			Sample	PID Reading (PPM)	Electrical Conductivity (mS/cm)	Well Completion	
Depth (m)	Graphic Log	Description	I.D.	0 1 2 3 4 5	0 5 10	Well Construction	Details

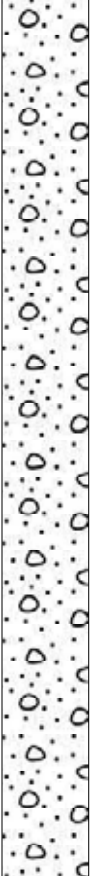

	Lithology Legend  SW  CL	Contractor:
		Date of construction: 3 / Jun / 2021 Drilling method: Hand auger Logged by: DL Drawn by: Danielle L. Reviewed by: Brent S.

Project Details			Borehole ID		Location		
Project Number:	2021-3981		21HA10		Northing (m):	5928990	
Client:	CIMA+				Easting (m):	329680	
Location:	Whitemud Drive, Edmonton				Elevation (masl):	663	
Subsurface Profile			Sample	PID Reading (PPM)	Electrical Conductivity (mS/cm)	Well Completion	
Depth (m)	Graphic Log	Description	I.D.	0 1 2 3 4 5	0 5 10	Well Construction	Details

0		CLAY, silty, trace sand and gravel, blackish brown, slightly moist, soft, mottled	0.0-0.3m	• 1	3.23 X		Backfilled with hand auger cuttings	
0.1								
0.2			0.4 m - Decreasing sand, increasing clay and firmness with depth, slightly soft, moist					
0.3			0.6 m - White precipitates					
0.4								
0.5								
0.6								
0.7								
0.8			0.6-1.0m	• 0	3.83 X			
0.9								
1	1.00 m							
1.1		1.0 m - End of Hole						
1.2								
1.3								
1.4								

	Lithology Legend  CL	Contractor:
		Date of construction: 3 / Jun / 2021 Drilling method: Hand auger Logged by: DL Drawn by: Danielle L. Reviewed by: Brent S.





Project Details		Borehole ID	Location			
Project Number:	2021-3981	21HA11	Northing (m):	5928979		
Client:	CIMA+		Easting (m):	330161		
Location:	Whitemud Drive, Edmonton		Elevation (masl):	659		
Subsurface Profile		Sample	PID Reading (PPM)	Electrical Conductivity (mS/cm)	Well Completion	
Depth (m)	Graphic Log	Description	I.D.		Well Construction	Details

0		CLAY, silty, trace sand and gravel, brown, dry to moist, slightly plastic	0.0-0.3m	• 1	5.39 X		Backfilled with hand auger cuttings
0.1							
0.2							
0.3							
0.4	0.40 m	SAND, clayey, silty. brown, dry					
0.5	0.50 m	CLAY, silty, dark brown, moist to dry, slightly firm, white precipitates, oxides					
0.6							
0.7							
0.8			0.6-1.0m	• 0	5.44 X		
0.9							
1	1.00 m						
1.1		1.0 m - End of Hole					
1.2							
1.3							
1.4							

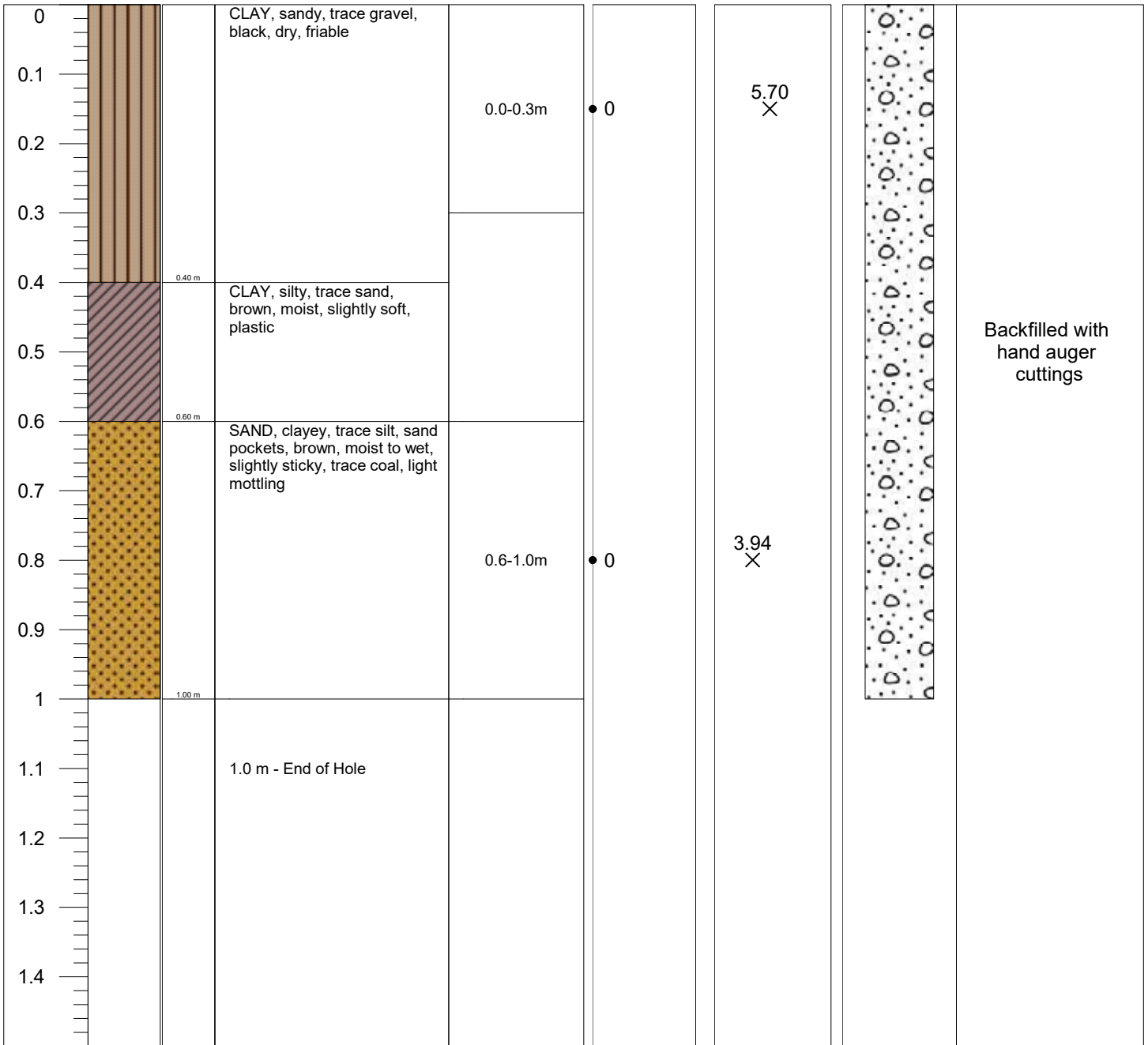
	Lithology Legend SW CL	Contractor:
		Date of construction: 3 / Jun / 2021 Drilling method: Hand auger Logged by: DL Drawn by: Danielle L. Reviewed by: Brent S.



Project Details			Borehole ID		Location		
Project Number:	2021-3981		21HA12		Northing (m):	5928965	
Client:	CIMA+				Easting (m):	330754	
Location:	Whitemud Drive, Edmonton				Elevation (masl):	647	
Subsurface Profile			Sample	PID Reading (PPM)	Electrical Conductivity (mS/cm)	Well Completion	
Depth (m)	Graphic Log	Description	I.D.	0 1 2 3 4 5	0 5 10	Well Construction	Details



	Lithology Legend  SW  ML  CL	Contractor:
		Date of construction: 3 / Jun / 2021 Drilling method: Hand auger Logged by: DL Drawn by: Danielle L. Reviewed by: Brent S.

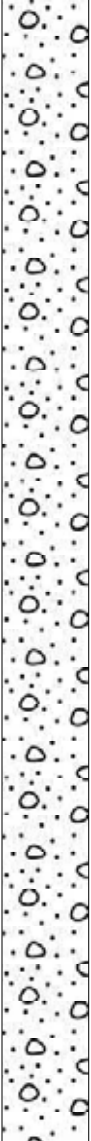

Project Details			Borehole ID		Location		
Project Number:	2021-3981		21HA13		Northing (m):	5928996	
Client:	CIMA+				Easting (m):	330463	
Location:	Whitemud Drive, Edmonton				Elevation (masl):	626	
Subsurface Profile			Sample	PID Reading (PPM)	Electrical Conductivity (mS/cm)	Well Completion	
Depth (m)	Graphic Log	Description	I.D.	0 1 2 3 4 5	0 5 10	Well Construction	Details

0		CLAY, silty, trace sand, black, moist, soft	0.0-0.3m	● 0	2.58 X		Backfilled with hand auger cuttings
0.1							
0.2							
0.3	0.30 m	CLAY, silty, trace sand, brown, moist, firm					
0.4							
0.5							
0.6							
0.7							
0.8							
0.9							
1		1.0 m - Increasing sand with depth					
1.1			1.0-1.3m	● 0	2.38 X		
1.2							
1.3	1.30 m						
1.4		1.3 m - End of Hole					

	Lithology Legend  CL	Contractor:
		Date of construction: 4 / Jun / 2021 Drilling method: Hand auger Logged by: DL Drawn by: Danielle L. Reviewed by: Brent S.

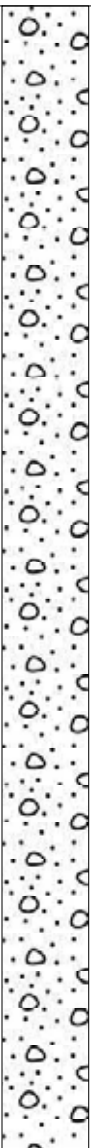

Project Details			Borehole ID		Location		
Project Number:	2021-3981		21HA14		Northing (m):	5929002	
Client:	CIMA+				Easting (m):	330451	
Location:	Whitemud Drive, Edmonton				Elevation (masl):	626	
Subsurface Profile			Sample	PID Reading (PPM)	Electrical Conductivity (mS/cm)	Well Completion	
Depth (m)	Graphic Log	Description	I.D.	0 1 2 3 4 5	0 5 10	Well Construction	Details

0		CLAY, silty, trace sand, black, dry to moist, loose	0.0-0.3m	● 0	0.75 X		Backfilled with hand auger cuttings
0.1							
0.2							
0.3	0.30 m	CLAY, silty, trace sand, brown, moist, firm					
0.4							
0.5							
0.6							
0.7							
0.8							
0.9							
1							
1.1			1.0-1.3m	● 0	1.98 X		
1.2							
1.3	1.30 m						
1.4		1.3 m - End of Hole					

	Lithology Legend  CL	Contractor:
		Date of construction: 4 / Jun / 2021 Drilling method: Hand auger Logged by: DL Drawn by: Danielle L. Reviewed by: Brent S.

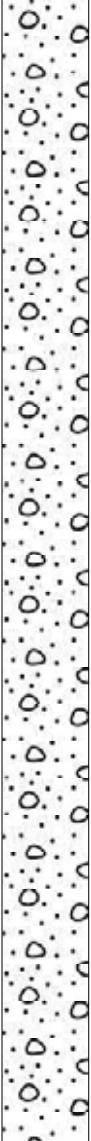

Project Details			Borehole ID		Location		
Project Number:	2021-3981		21HA15		Northing (m):	5928981	
Client:	CIMA+				Easting (m):	330451	
Location:	Whitemud Drive, Edmonton				Elevation (masl):	626	
Subsurface Profile			Sample	PID Reading (PPM)	Electrical Conductivity (mS/cm)	Well Completion	
Depth (m)	Graphic Log	Description	I.D.	0 1 2 3 4 5	0 5 10	Well Construction	Details

0		CLAY, silty, trace sand, black, dry, loose, trace roots	0.0-0.3m	• 1	1.43 X		Backfilled with hand auger cuttings
0.1							
0.2							
0.3	0.30 m	CLAY, silty, trace sand, brown, moist, firm					
0.4							
0.5							
0.6							
0.7							
0.8							
0.9							
1							
1.1			1.0-1.3m	• 0	1.75 X		
1.2							
1.3	1.30 m						
1.4		1.3 m - End of Hole					



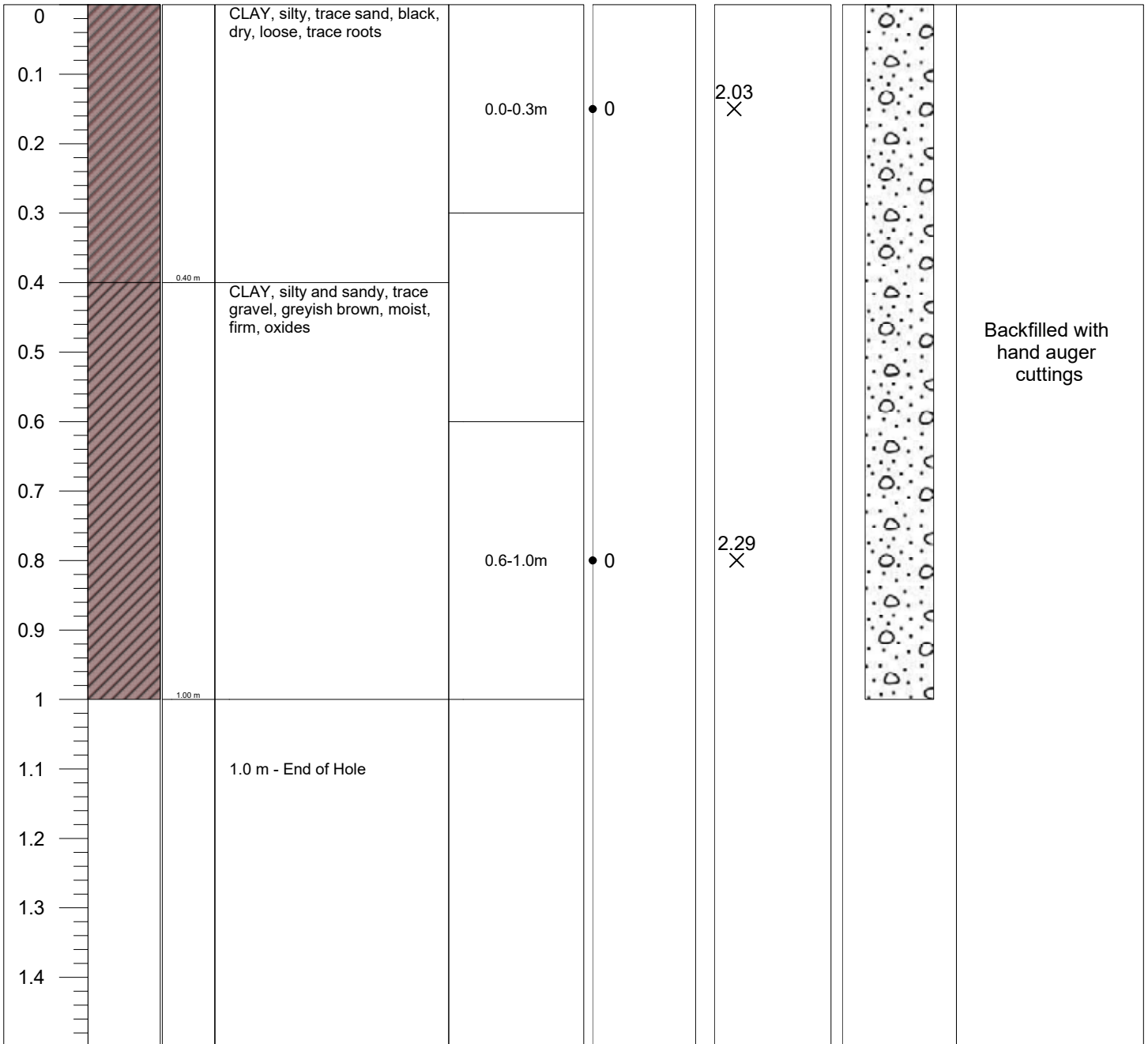

	Lithology Legend  CL	Contractor:
		Date of construction: 4 / Jun / 2021 Drilling method: Hand auger Logged by: DL Drawn by: Danielle L. Reviewed by: Brent S.



Project Details			Borehole ID		Location		
Project Number:	2021-3981		21HA16		Northing (m):	5928981	
Client:	CIMA+				Easting (m):	330421	
Location:	Whitemud Drive, Edmonton				Elevation (masl):	626	
Subsurface Profile			Sample	PID Reading (PPM)	Electrical Conductivity (mS/cm)	Well Completion	
Depth (m)	Graphic Log	Description	I.D.	0 1 2 3 4 5	0 5 10	Well Construction	Details

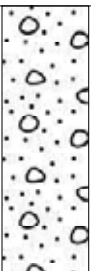

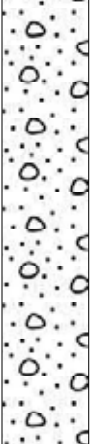
	Lithology Legend  CL	Contractor:
		Date of construction: 4 / Jun / 2021 Drilling method: Hand auger Logged by: DL Drawn by: Danielle L. Reviewed by: Brent S.



Project Details			Borehole ID		Location		
Project Number:	2021-3981		21HA17		Northing (m):	5929002	
Client:	CIMA+				Easting (m):	330471	
Location:	Whitemud Drive, Edmonton				Elevation (masl):	626	
Subsurface Profile			Sample	PID Reading (PPM)	Electrical Conductivity (mS/cm)	Well Completion	
Depth (m)	Graphic Log	Description	I.D.	0 1 2 3 4 5	0 5 10	Well Construction	Details

0		CLAY, silty, trace sand, black, moist, loose, trace roots	0.0-0.3m	● 0	2.08 X		Backfilled with hand auger cuttings
0.1							
0.2							
0.3							
0.4							
0.5		0.5 m - Geofabric					
0.6		CLAY, silty, sandy, brown, moist, soft	0.6-1.0m	● 0	2.71 X		Backfilled with hand auger cuttings
0.7							
0.8							
0.9							
1.0		1.0 m - End of Hole					
1.1							
1.2							
1.3							
1.4							

	Lithology Legend  CL	Contractor:
		Date of construction: 4 / Jun / 2021 Drilling method: Hand auger Logged by: DL Drawn by: Danielle L. Reviewed by: Brent S.

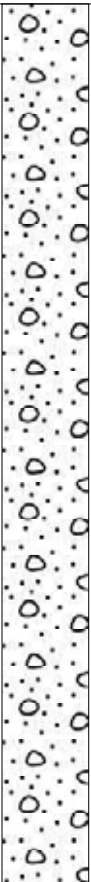

Project Details			Borehole ID		Location		
Project Number:	2021-3981		21HA18		Northing (m):	5929001	
Client:	CIMA+				Easting (m):	330669	
Location:	Whitemud Drive, Edmonton				Elevation (masl):	642	
Subsurface Profile			Sample	PID Reading (PPM)	Electrical Conductivity (mS/cm)	Well Completion	
Depth (m)	Graphic Log	Description	I.D.	0 1 2 3 4 5	0 5 10	Well Construction	Details

0		CLAY, silty, trace sand and gravel, black, moist to dry, slightly friable	0.0-0.3m	• 1	3.82 X		Backfilled with hand auger cuttings
0.1							
0.2							
0.3							
0.4	0.40 m	CLAY, silty, trace sand, light brown, dry to moist, slightly friable					
0.5							
0.6							
0.7							
0.8			0.6-1.0m	• 0	6.24 X		
0.9							
1	1.00 m	1.0 m - End of Hole					
1.1							
1.2							
1.3							
1.4							

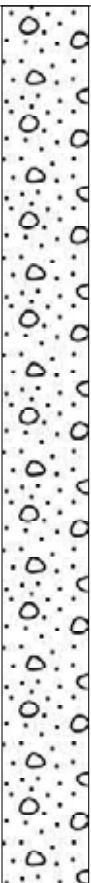

	Lithology Legend  CL	Contractor:
		Date of construction: 3 / Jun / 2021 Drilling method: Hand auger Logged by: DL Drawn by: Danielle L. Reviewed by: Brent S.



Project Details			Borehole ID		Location		
Project Number:	2021-3981		21HA19		Northing (m):	5929001	
Client:	CIMA+				Easting (m):	330420	
Location:	Whitemud Drive, Edmonton				Elevation (masl):	626	
Subsurface Profile			Sample	PID Reading (PPM)	Electrical Conductivity (mS/cm)	Well Completion	
Depth (m)	Graphic Log	Description	I.D.	0 1 2 3 4 5	0 5 10	Well Construction	Details

0		CLAY, silty and sandy, black, dry to moist, loose, salt staining at surface	0.0-0.3m	● 0	11.58 X		Backfilled with hand auger cuttings
0.1							
0.2							
0.3							
0.4	0.40 m	CLAY, silty and sandy, trace gravel, greyish brown, moist, firm, oxides					
0.5							
0.6							
0.7							
0.8			0.6-1.0m	● 0	6.52 X		
0.9							
1	1.00 m	1.0 m - End of Hole					
1.1							
1.2							
1.3							
1.4							

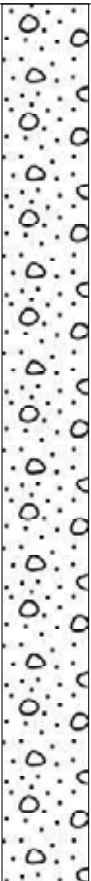
	Lithology Legend  ML	Contractor:
		Date of construction: 4 / Jun / 2021 Drilling method: Hand auger Logged by: DL Drawn by: Danielle L. Reviewed by: Brent S.

Project Details			Borehole ID		Location		
Project Number:	2021-3981		21HA20		Northing (m):	5929010	
Client:	CIMA+				Easting (m):	330319	
Location:	Whitemud Drive, Edmonton				Elevation (masl):	648	
Subsurface Profile			Sample	PID Reading (PPM)	Electrical Conductivity (mS/cm)	Well Completion	
Depth (m)	Graphic Log	Description	I.D.	0 1 2 3 4 5	0 5 10	Well Construction	Details

0		CLAY, sandy and silty, trace gravel, blackish brown, moist to dry, firm	0.0-0.3m	• 1	5.00 X		Backfilled with hand auger cuttings
0.1							
0.2							
0.3	0.30 m						
0.4		CLAY, trace silt and gravel, dark brown, moist, firm	0.6-1.0m	• 1	6.28 X		
0.5							
0.6		0.6 m - White precipitates					
0.7							
0.8							
0.9							
1	1.00 m						
1.1		1.0 m - End of Hole					
1.2							
1.3							
1.4							



	Lithology Legend  ML  CL	Contractor:
		Date of construction: 3 / Jun / 2021 Drilling method: Hand auger Logged by: DL Drawn by: Danielle L. Reviewed by: Brent S.



Project Details			Borehole ID		Location		
Project Number:	2021-3981		21HA21		Northing (m):	5929035	
Client:	CIMA+				Easting (m):	331347	
Location:	Whitemud Drive, Edmonton				Elevation (masl):	659	
Subsurface Profile			Sample	PID Reading (PPM)	Electrical Conductivity (mS/cm)	Well Completion	
Depth (m)	Graphic Log	Description	I.D.	0 1 2 3 4 5	0 5 10	Well Construction	Details

0		CLAY, sandy, silty, dark brown, friable, dry, trace roots	0.0-0.3m	● 0	3.09 X		Backfilled with hand auger cuttings
0.1							
0.2							
0.3							
0.4		0.4 m - Increasing clay content and firmness with depth, trace coal					
0.5	0.50 m	CLAY, sandy, silty, fine sand pockets, dark brown, moist, soft, plastic					
0.6							
0.7							
0.8			0.6-1.0m	● 0	2.89 X		
0.9							
1	1.00 m						
1.1		1.0 m - End of Hole					
1.2							
1.3							
1.4							

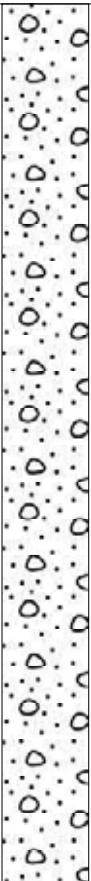

	Lithology Legend ML	Contractor:
		Date of construction: 2 / Jun / 2021 Drilling method: Hand auger Logged by: DL Drawn by: Danielle L. Reviewed by: Brent S.



Project Details			Borehole ID		Location		
Project Number:	2021-3981		21HA22		Northing (m):	5929027	
Client:	CIMA+				Easting (m):	331121	
Location:	Whitemud Drive, Edmonton				Elevation (masl):	656	
Subsurface Profile			Sample	PID Reading (PPM)	Electrical Conductivity (mS/cm)	Well Completion	
Depth (m)	Graphic Log	Description	I.D.	0 1 2 3 4 5	0 5 10	Well Construction	Details

0		CLAY, sandy, silty, brown, friable, dry, trace roots	0.0-0.3m	• 2	2.87 X		Backfilled with hand auger cuttings
0.1							
0.2							
0.3							
0.4		0.4 m - Moist					
0.5		0.5 m - Trace coal					
0.6	0.60 m						
0.7		SAND, fine-grained, clayey, light brown, moist, slightly friable	0.6-1.0m	• 0	1.76 X		
0.8							
0.9							
1.0	1.00 m						
1.1		1.0 m - End of Hole					
1.2							
1.3							
1.4							

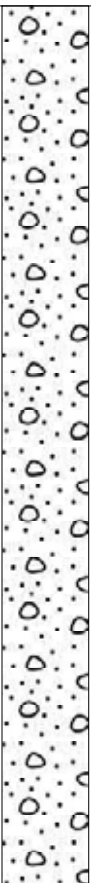
	Lithology Legend  SW  ML	Contractor:
		Date of construction: 2 / Jun / 2021 Drilling method: Hand auger Logged by: DL Drawn by: Danielle L. Reviewed by: Brent S.

Project Details			Borehole ID		Location		
Project Number:	2021-3981		21HA23		Northing (m):	5929024	
Client:	CIMA+				Easting (m):	329949	
Location:	Whitemud Drive, Edmonton				Elevation (masl):	660	
Subsurface Profile			Sample	PID Reading (PPM)	Electrical Conductivity (mS/cm)	Well Completion	
Depth (m)	Graphic Log	Description	I.D.	0 1 2 3 4 5	0 5 10	Well Construction	Details

0		CLAY, sandy, trace silt, back, dry to moist, soft	0.0-0.3m	● 0	2.09 X		Backfilled with hand auger cuttings
0.1							
0.2							
0.3	0.30 m	CLAY/SAND, light brown, moist, soft, plastic					
0.4							
0.5							
0.6							
0.7							
0.8			0.6-1.0m	● 0	3.50 X		
0.9		0.9 m - Moist to wet					
1	1.00 m						
1.1		1.0 m - End of Hole					
1.2							
1.3							
1.4							

	Lithology Legend  SW  ML	Contractor:
		Date of construction: 2 / Jun / 2021 Drilling method: Hand auger Logged by: DL Drawn by: Danielle L. Reviewed by: Brent S.



Project Details			Borehole ID		Location		
Project Number:	2021-3981		21HA24		Northing (m):	5929178	
Client:	CIMA+				Easting (m):	329488	
Location:	Whitemud Drive, Edmonton				Elevation (masl):	667	
Subsurface Profile			Sample	PID Reading (PPM)	Electrical Conductivity (mS/cm)	Well Completion	
Depth (m)	Graphic Log	Description	I.D.	0 1 2 3 4 5	0 5 10	Well Construction	Details

0		CLAY, sandy, trace gravel, black, dry to moist, increasing sand content with depth	0.0-0.3m	● 0	3.19 X		Backfilled with hand auger cuttings
0.1							
0.2							
0.3							
0.4	0.40 m	CLAY, trace sand, silt and gravel, black and light brown, moist, slightly firm, trace oxides,					
0.5							
0.6	0.60 m	CLAY, sandy, trace gravel, brown, moist, slightly soft	0.6-1.0m	● 0	6.20 X		
0.7							
0.8							
0.9							
1	1.00 m	1.0 m - End of Hole					
1.1							
1.2							
1.3							
1.4							

	Lithology Legend ML CL	Contractor:
		Date of construction: 2 / Jun / 2021 Drilling method: Hand auger Logged by: DL Drawn by: Danielle L. Reviewed by: Brent S.

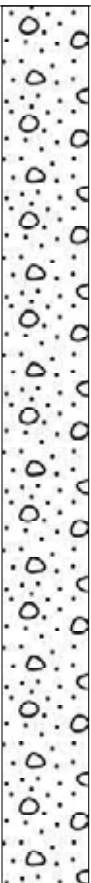

Project Details			Borehole ID		Location		
Project Number:	2021-3981		21HA25		Northing (m):	5929509	
Client:	CIMA+				Easting (m):	329401	
Location:	Whitemud Drive, Edmonton				Elevation (masl):	666	
Subsurface Profile			Sample	PID Reading (PPM)	Electrical Conductivity (mS/cm)	Well Completion	
Depth (m)	Graphic Log	Description	I.D.	0 1 2 3 4 5	0 5 10	Well Construction	Details

0		CLAY, sandy, brown and black, dry, friable, slightly soft, increasing moisture with depth	0.0-0.3m	● 0	2.96 X		Backfilled with hand auger cuttings
0.1							
0.2							
0.3							
0.4	0.40 m	CLAY, silty, brown, moist, soft, slightly plastic, orange mottling			6.88 X		
0.5							
0.6							
0.7							
0.8			0.6-1.0m	● 0			
0.9							
1	1.00 m	1.0 m - End of Hole					
1.1							
1.2							
1.3							
1.4							

	Lithology Legend  ML  CL	Contractor:
		Date of construction: 2 / Jun / 2021 Drilling method: Hand auger Logged by: DL Drawn by: Danielle L. Reviewed by: Brent S.

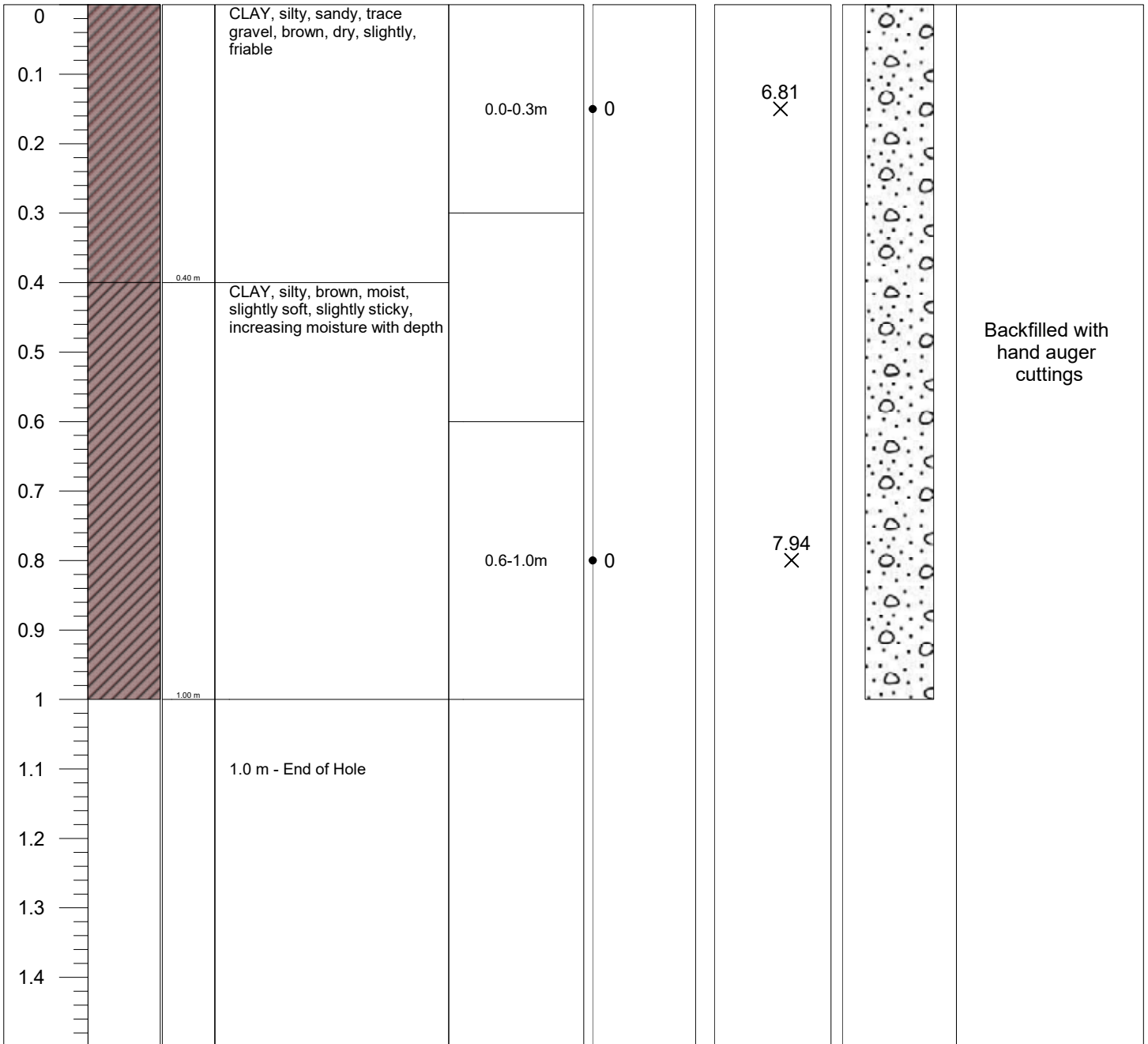



Project Details			Borehole ID		Location		
Project Number:	2021-3981		21HA26		Northing (m):	5929645	
Client:	CIMA+				Easting (m):	329390	
Location:	Whitemud Drive, Edmonton				Elevation (masl):	664	
Subsurface Profile			Sample	PID Reading (PPM)	Electrical Conductivity (mS/cm)	Well Completion	
Depth (m)	Graphic Log	Description	I.D.	0 1 2 3 4 5	0 5 10	Well Construction	Details

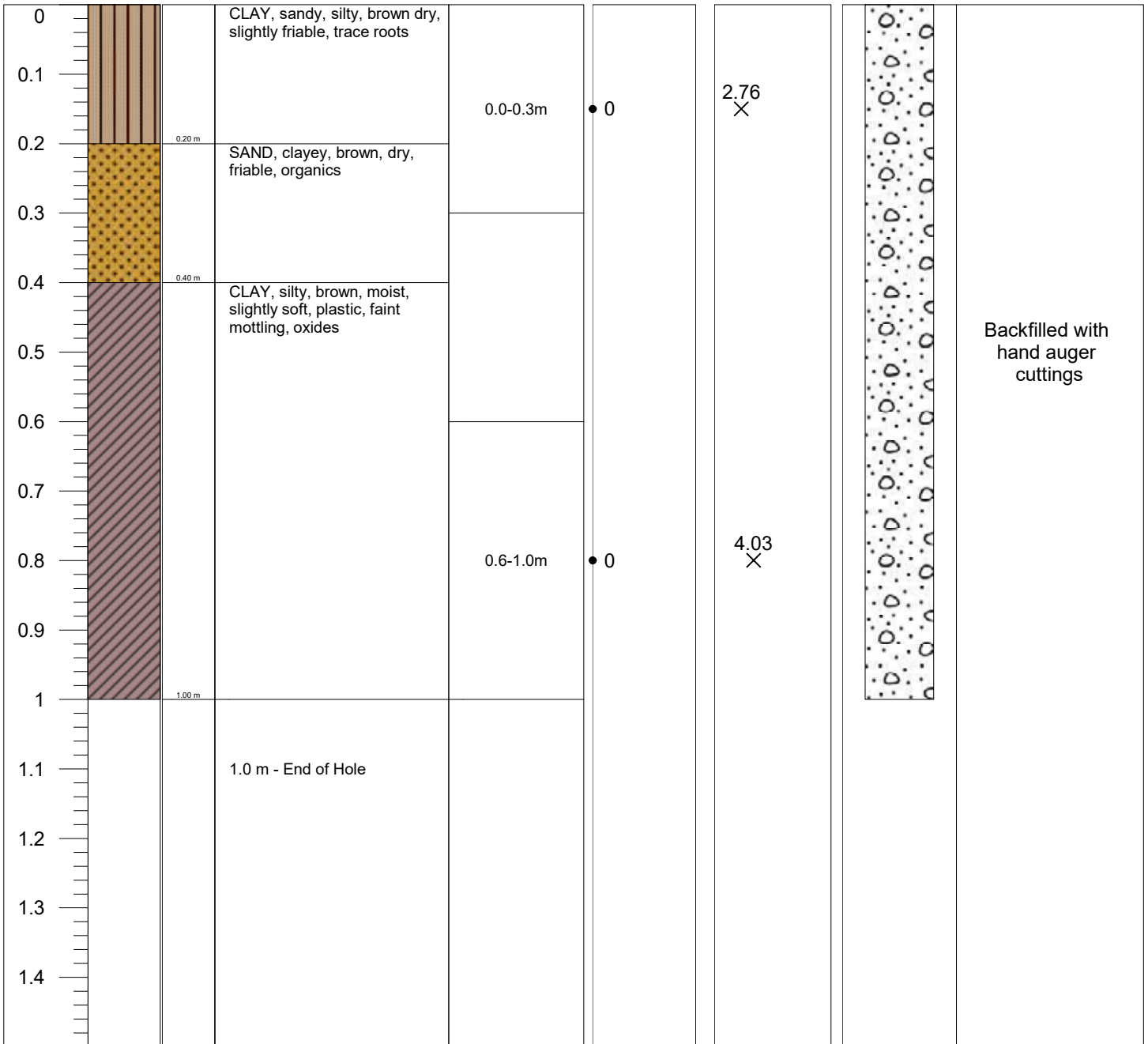

	Lithology Legend  CL	Contractor:
		Date of construction: 2 / Jun / 2021 Drilling method: Hand auger Logged by: DL Drawn by: Danielle L. Reviewed by: Brent S.



Project Details			Borehole ID		Location		
Project Number:	2021-3981		21HA27		Northing (m):	5930129	
Client:	CIMA+				Easting (m):	329400	
Location:	Whitemud Drive, Edmonton				Elevation (masl):	662	
Subsurface Profile			Sample	PID Reading (PPM)	Electrical Conductivity (mS/cm)	Well Completion	
Depth (m)	Graphic Log	Description	I.D.	0 1 2 3 4 5	0 5 10	Well Construction	Details



	<p>Lithology Legend</p> <p>  SW  ML  CL </p>	Contractor:
		Date of construction: 2 / Jun / 2021 Drilling method: Hand auger Logged by: DL Drawn by: Danielle L. Reviewed by: Brent S.

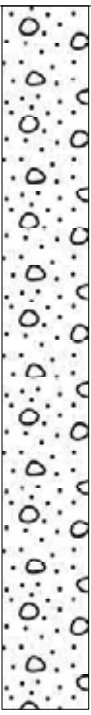

Project Details			Borehole ID		Location		
Project Number:	2021-3981		21HA28		Northing (m):	5930501	
Client:	CIMA+				Easting (m):	329418	
Location:	Whitemud Drive, Edmonton				Elevation (masl):	660	
Subsurface Profile			Sample	PID Reading (PPM)	Electrical Conductivity (mS/cm)	Well Completion	
Depth (m)	Graphic Log	Description	I.D.	0 1 2 3 4 5	0 5 10	Well Construction	Details

0		CLAY, sandy, silty, brown and black, dry, slightly friable, increasing sand with depth	0.0-0.3m	● 0	3,28 X		Backfilled with hand auger cuttings
0.1							
0.2							
0.3							
0.4							
0.5							
0.6	0.60 m	CLAY, sandy, gravel, brown	0.6-0.8m	● 0	3,18 X		
0.7							
0.8	0.80 m	0.8 m - End of Hole (Refusal)					
0.9							
1							
1.1							
1.2							
1.3							
1.4							

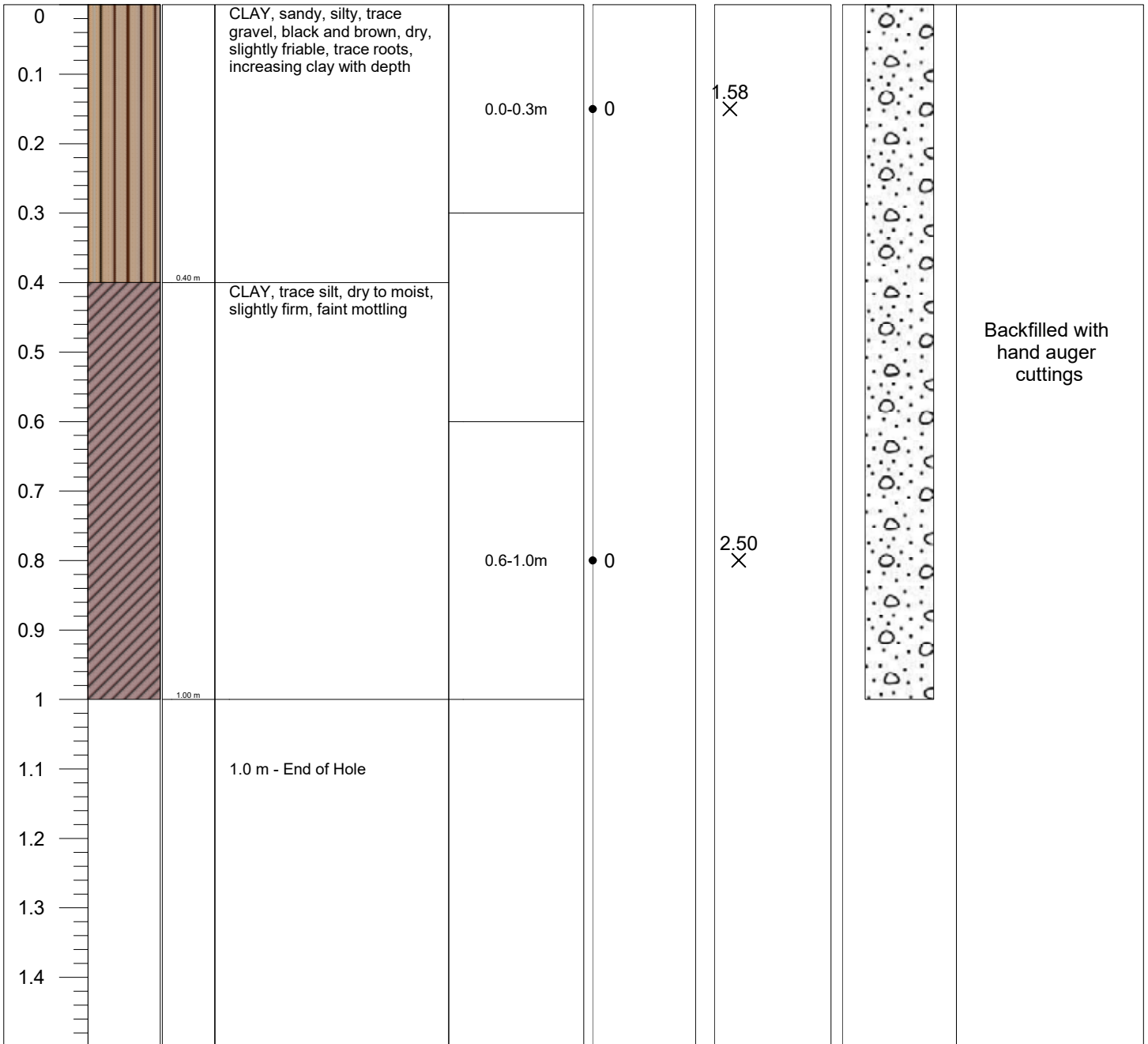

	Lithology Legend  ML	Contractor:
		Date of construction: 2 / Jun / 2021 Drilling method: Hand auger Logged by: DL Drawn by: Danielle L. Reviewed by: Brent S.



Project Details			Borehole ID		Location		
Project Number:	2021-3981		21HA29		Northing (m):	5930892	
Client:	CIMA+				Easting (m):	329492	
Location:	Whitemud Drive, Edmonton				Elevation (masl):	656	
Subsurface Profile			Sample	PID Reading (PPM)	Electrical Conductivity (mS/cm)	Well Completion	
Depth (m)	Graphic Log	Description	I.D.	0 1 2 3 4 5	0 5 10	Well Construction	Details

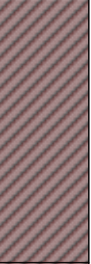
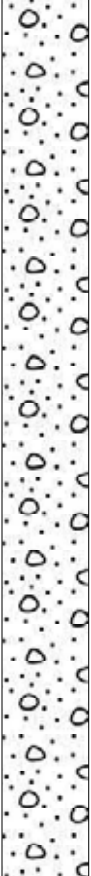

	Lithology Legend  ML  CL	Contractor:
		Date of construction: 2 / Jun / 2021 Drilling method: Hand auger Logged by: DL Drawn by: Danielle L. Reviewed by: Brent S.

Project Details			Borehole ID		Location		
Project Number:	2021-3981		21HA30		Northing (m):	5928998	
Client:	CIMA+				Easting (m):	331341	
Location:	Whitemud Drive, Edmonton				Elevation (masl):	660	
Subsurface Profile			Sample	PID Reading (PPM)	Electrical Conductivity (mS/cm)	Well Completion	
Depth (m)	Graphic Log	Description	I.D.	0 1 2 3 4 5	0 5 10	Well Construction	Details

0		CLAY, silty, sandy, dark brown, dry to moist, trace roots, salt staining at surface	0.0-0.3m	● 0	2.83 X		Backfilled with hand auger cuttings
0.1		0.30 m	CLAY, silty, trace sand, brown, moist, soft				
0.2		SAND/CLAY, silty, brown to rust coloured, moist, soft, plastic	0.6-1.0m	● 0	0.94 X		
0.3		0.50 m					
0.4							
0.5							
0.6							
0.7							
0.8							
0.9							
1							
1.1		1.0 m - End of Hole					
1.2							
1.3							
1.4							

	Lithology Legend  SW  CL	Contractor:
		Date of construction: 2 / Jun / 2021 Drilling method: Hand auger Logged by: DL Drawn by: Danielle L. Reviewed by: Brent S.



TECHNICAL MEMORANDUM

APPENDIX B – SITE PHOTOS



Associated
Engineering

GLOBAL PERSPECTIVE.
LOCAL FOCUS.



Photograph 1 – Stressed vegetation at 21HA06 location. June 3, 2021.



Associated
Engineering

GLOBAL PERSPECTIVE.
LOCAL FOCUS.



Photograph 2 – Rainbow Valley Bridges, facing east towards former spill area and 21HA13, 21HA14, and 21HA15 locations. June 4, 2021.



Associated
Engineering

GLOBAL PERSPECTIVE.
LOCAL FOCUS.



Photograph 3 – Salt staining at 21HA19, adjacent to pier below Rainbow Valley Bridges.
June 4, 2021.



Associated
Engineering

GLOBAL PERSPECTIVE.
LOCAL FOCUS.



Photograph 4 – Bare ground near 21HA20 location, facing east toward Rainbow Valley Bridges. June 3, 2021.



Associated
Engineering

GLOBAL PERSPECTIVE.
LOCAL FOCUS.



Photograph 5 – Salt staining at 21HA24 location, facing north along Whitemud Drive.
June 2, 2021.



Associated
Engineering

GLOBAL PERSPECTIVE.
LOCAL FOCUS.



Photograph 6 – Stressed vegetation at 21HA28 location, facing southwest toward northbound Whitemud Drive lanes. June 2, 2021.

APPENDIX C – LABORATORY REPORT



Your P.O. #: 2021-3981.001-140
 Your Project #: 2021-3981.001.140
 Site Location: TERWILLIGAR DR STAGE 2

Attention: Danielle Loiseau

ASSOCIATED ENGINEERING ALBERTA LTD.
 500 - 9888 Jasper Avenue
 Edmonton, AB
 CANADA T5J 5C6

Your C.O.C. #: 637640-01-01, 637640-02-01, 637640-03-01, 637640-04-01, 637640-05-01, 637640-06-01, 637640-07-01

Report Date: 2021/06/18
 Report #: R3034724
 Version: 2 - Final

CERTIFICATE OF ANALYSIS

BV LABS JOB #: C138809

Received: 2021/06/04, 16:57

Sample Matrix: Soil
 # Samples Received: 56

Analyses	Date		Laboratory Method	Analytical Method
	Quantity	Extracted		
BTEX/F1 by HS GC/MS/FID (MeOH extract) (1, 3)	29	N/A	2021/06/10 AB SOP-00039	CCME CWS/EPA 8260d m
BTEX/F1 by HS GC/MS/FID (MeOH extract) (1, 3)	1	N/A	2021/06/11 AB SOP-00039	CCME CWS/EPA 8260d m
F1-BTEX (1)	30	N/A	2021/06/11	Auto Calc
Cation/EC Ratio (1)	12	N/A	2021/06/12	Auto Calc
Cation/EC Ratio (1)	25	N/A	2021/06/13	Auto Calc
Chloride (Soluble) (1)	37	2021/06/11	2021/06/12 AB SOP-00033 / AB SOP-00020	SM 23-4500-Cl-E m
Hexavalent Chromium (1, 4)	13	2021/06/11	2021/06/11 AB SOP-00063	SM 23 3500-Cr B m
Hexavalent Chromium (1, 4)	24	2021/06/11	2021/06/12 AB SOP-00063	SM 23 3500-Cr B m
Conductivity @25C (Soluble) (1)	12	2021/06/12	2021/06/12 AB SOP-00033 / AB SOP-00004	SM 23 2510 B m
Conductivity @25C (Soluble) (1)	25	2021/06/12	2021/06/13 AB SOP-00033 / AB SOP-00004	SM 23 2510 B m
CCME Hydrocarbons (F2-F4 in soil) (1, 5)	12	2021/06/10	2021/06/11 AB SOP-00036	CCME PHC-CWS m
CCME Hydrocarbons (F2-F4 in soil) (1, 5)	18	2021/06/10	2021/06/12 AB SOP-00036	CCME PHC-CWS m
CCME Hydrocarbons (F4G in soil) (1, 5)	1	2021/06/10	2021/06/14 AB SOP-00036 AB SOP-00040	CCME PHC-CWS m
Elements by ICPMS - Soils (1)	36	2021/06/11	2021/06/12 AB SOP-00001 / AB SOP-00043	EPA 6020b R2 m
Elements by ICPMS - Soils (1)	1	2021/06/12	2021/06/12 AB SOP-00001 / AB SOP-00043	EPA 6020b R2 m
Sum of Cations, Anions (1)	27	N/A	2021/06/12	Auto Calc
Sum of Cations, Anions (1)	10	N/A	2021/06/13	Auto Calc
Moisture (1)	18	N/A	2021/06/10 AB SOP-00002	CCME PHC-CWS m
Moisture (1)	35	N/A	2021/06/11 AB SOP-00002	CCME PHC-CWS m
Benzo[a]pyrene Equivalency (1)	11	N/A	2021/06/12	Auto Calc
PAH in Soil by GC/MS (1)	11	2021/06/10	2021/06/12 AB SOP-00036 / AB SOP-00003	EPA 3540C/8270E m



Your P.O. #: 2021-3981.001-140
 Your Project #: 2021-3981.001.140
 Site Location: TERWILLIGAR DR STAGE 2

Attention: Danielle Loiseau

ASSOCIATED ENGINEERING ALBERTA LTD.
 500 - 9888 Jasper Avenue
 Edmonton, AB
 CANADA T5J 5C6

Your C.O.C. #: 637640-01-01, 637640-02-01, 637640-03-01, 637640-04-01, 637640-05-01, 637640-06-01, 637640-07-01

Report Date: 2021/06/18
 Report #: R3034724
 Version: 2 - Final

CERTIFICATE OF ANALYSIS

BV LABS JOB #: C138809

Received: 2021/06/04, 16:57

Sample Matrix: Soil
 # Samples Received: 56

Analyses	Quantity	Date Extracted	Date Analyzed	Laboratory Method	Analytical Method
pH @25C (1:2 Calcium Chloride Extract) (1)	37	2021/06/11	2021/06/11	AB SOP-00033 / AB SOP-00006	SM 23 4500 H+B m
Particle Size by Sieve (75 micron) (1)	6	N/A	2021/06/11		Auto Calc
Particle Size by Sieve (1)	6	N/A	2021/06/11	AB SOP-00022	ASTM D6913-17 m
Sodium Adsorption Ratio (1)	27	N/A	2021/06/12		Auto Calc
Sodium Adsorption Ratio (1)	10	N/A	2021/06/13		Auto Calc
Soluble Ions (1)	37	2021/06/11	2021/06/12	AB SOP-00033 / AB SOP-00042	EPA 6010d R5 m
Soluble Paste (1)	12	2021/06/11	2021/06/11	AB SOP-00033	Carter 2nd ed 15.2 m
Soluble Paste (1)	25	2021/06/11	2021/06/12	AB SOP-00033	Carter 2nd ed 15.2 m
Soluble Boron Calculation (1)	27	N/A	2021/06/12		Auto Calc
Soluble Boron Calculation (1)	10	N/A	2021/06/13		Auto Calc
Soluble Ions Calculation (1)	37	N/A	2021/06/11		Auto Calc
Theoretical Gypsum Requirement (1, 6)	27	N/A	2021/06/12		Auto Calc
Theoretical Gypsum Requirement (1, 6)	10	N/A	2021/06/13		Auto Calc
Moisture (2)	2	N/A	2021/06/14	CAM SOP-00313	Maxxam Method
Moisture (2)	1	N/A	2021/06/15	CAM SOP-00313	Maxxam Method
PFAS in soil by SPE/LCMS (2)	3	2021/06/15	2021/06/16	CAM SOP-00894	ASTM D7968-17a m

Remarks:

Bureau Veritas is accredited to ISO/IEC 17025 for specific parameters on scopes of accreditation. Unless otherwise noted, procedures used by Bureau Veritas are based upon recognized Provincial, Federal or US method compendia such as CCME, MELCC, EPA, APHA.

All work recorded herein has been done in accordance with procedures and practices ordinarily exercised by professionals in Bureau Veritas' profession using accepted testing methodologies, quality assurance and quality control procedures (except where otherwise agreed by the client and Bureau Veritas in writing). All data is in statistical control and has met quality control and method performance criteria unless otherwise noted. All method blanks are reported; unless indicated otherwise, associated sample data are not blank corrected. Where applicable, unless otherwise noted, Measurement Uncertainty has not been accounted for when stating conformity to the referenced standard.

Bureau Veritas liability is limited to the actual cost of the requested analyses, unless otherwise agreed in writing. There is no other warranty expressed or



Your P.O. #: 2021-3981.001-140
Your Project #: 2021-3981.001.140
Site Location: TERWILLIGAR DR STAGE 2

Attention: Danielle Loiseau

ASSOCIATED ENGINEERING ALBERTA LTD.
500 - 9888 Jasper Avenue
Edmonton, AB
CANADA T5J 5C6

Your C.O.C. #: 637640-01-01, 637640-02-01, 637640-03-01, 637640-04-01, 637640-05-01, 637640-06-01, 637640-07-01

Report Date: 2021/06/18
Report #: R3034724
Version: 2 - Final

CERTIFICATE OF ANALYSIS

BV LABS JOB #: C138809

Received: 2021/06/04, 16:57

implied. Bureau Veritas has been retained to provide analysis of samples provided by the Client using the testing methodology referenced in this report. Interpretation and use of test results are the sole responsibility of the Client and are not within the scope of services provided by Bureau Veritas, unless otherwise agreed in writing. Bureau Veritas is not responsible for the accuracy or any data impacts, that result from the information provided by the customer or their agent.

Solid sample results, except biota, are based on dry weight unless otherwise indicated. Organic analyses are not recovery corrected except for isotope dilution methods.

Results relate to samples tested. When sampling is not conducted by Bureau Veritas, results relate to the supplied samples tested.

This Certificate shall not be reproduced except in full, without the written approval of the laboratory.

Reference Method suffix "m" indicates test methods incorporate validated modifications from specific reference methods to improve performance.

* RPDs calculated using raw data. The rounding of final results may result in the apparent difference.

- (1) This test was performed by Bureau Veritas Calgary Environmental
- (2) This test was performed by Bureau Veritas Ontario (From Calgary)
- (3) No lab extraction date is given for F1BTEX & VOC samples that are field preserved with methanol. Extraction date is date sampled unless otherwise stated.
- (4) Some soil samples may react with the Cr(VI) spike reducing it to Cr(III). These samples are highly unlikely to contain native hexavalent chromium. Thus a failed spike recovery does not invalidate a negative result on the native sample.
- (5) All CCME results met required criteria unless otherwise stated in the report. The CWS PHC methods employed by Bureau Veritas Laboratories conform to all prescribed elements of the reference method and performance based elements have been validated. All modifications have been validated and proven equivalent following Alberta Environment's Interpretation of the Reference Method for the Canada-Wide Standard for Petroleum Hydrocarbons in Soil, Validation of Performance-Based Alternative Methods September 2003. Documentation is available upon request. Modifications from Reference Method for the Canada-wide Standard for Petroleum Hydrocarbons in Soil-Tier 1 Method: F2/F3/F4 data reported using validated cold solvent extraction instead of Soxhlet extraction.
- (6) TGR calculation is based on a theoretical SAR of 4. Salt Contamination and Assessment and remediation guideline 2001 recommended SAR is ranging 4-8. TGR is reported in tonnes/ha.

Encryption Key

Please direct all questions regarding this Certificate of Analysis to your Project Manager.

Customer Solutions, Western Canada Customer Experience Team

Email: customersolutionswest@bureauveritas.com

Phone# (780) 577-7100

=====

BV Labs has procedures in place to guard against improper use of the electronic signature and have the required "signatories", as per ISO/IEC 17025, signing the reports. For Service Group specific validation please refer to the Validation Signature Page.



BV Labs Job #: C138809
 Report Date: 2021/06/18

ASSOCIATED ENGINEERING ALBERTA LTD.
 Client Project #: 2021-3981.001.140
 Site Location: TERWILLIGAR DR STAGE 2
 Your P.O. #: 2021-3981.001-140
 Sampler Initials: RH

AT1 BTEX AND F1-F4 IN SOIL (VIALS)

BV Labs ID		ZY0019		ZY0021	ZY0023	ZY0026		
Sampling Date		2021/06/02		2021/06/03	2021/06/03	2021/06/02		
COC Number		637640-01-01		637640-01-01	637640-01-01	637640-01-01		
	UNITS	21HA01 (0.0-0.3M)	QC Batch	21HA02 (0.0-0.3M)	21HA03 (0.0-0.3M)	21HA04 (0.6-1.0M)	RDL	QC Batch
Ext. Pet. Hydrocarbon								
F2 (C10-C16 Hydrocarbons)	mg/kg	<10	A251730	<10	<10	<10	10	A251730
F3 (C16-C34 Hydrocarbons)	mg/kg	51	A251730	<50	<50	68	50	A251730
F4 (C34-C50 Hydrocarbons)	mg/kg	<50	A251730	<50	<50	<50	50	A251730
Reached Baseline at C50	mg/kg	Yes	A251730	Yes	Yes	Yes		A251730
Physical Properties								
Moisture	%	22	A251736	21	16	19	0.30	A251762
Volatiles								
Xylenes (Total)	mg/kg	<0.045	A249298	<0.045	<0.045	<0.045	0.045	A249298
F1 (C6-C10) - BTEX	mg/kg	<10	A249298	<10	<10	<10	10	A249298
Field Preserved Volatiles								
Benzene	mg/kg	<0.0050	A250930	<0.0050	<0.0050	<0.0050	0.0050	A250930
Toluene	mg/kg	<0.050	A250930	<0.050	<0.050	<0.050	0.050	A250930
Ethylbenzene	mg/kg	<0.010	A250930	<0.010	<0.010	<0.010	0.010	A250930
m & p-Xylene	mg/kg	<0.040	A250930	<0.040	<0.040	<0.040	0.040	A250930
o-Xylene	mg/kg	<0.020	A250930	<0.020	<0.020	<0.020	0.020	A250930
F1 (C6-C10)	mg/kg	<10	A250930	<10	<10	<10	10	A250930
Surrogate Recovery (%)								
1,4-Difluorobenzene (sur.)	%	96	A250930	95	94	94		A250930
4-Bromofluorobenzene (sur.)	%	106	A250930	107	108	108		A250930
D10-o-Xylene (sur.)	%	138	A250930	119	129	116		A250930
D4-1,2-Dichloroethane (sur.)	%	108	A250930	106	105	107		A250930
O-TERPHENYL (sur.)	%	91	A251730	93	101	90		A251730
RDL = Reportable Detection Limit								



BV Labs Job #: C138809
 Report Date: 2021/06/18

ASSOCIATED ENGINEERING ALBERTA LTD.
 Client Project #: 2021-3981.001.140
 Site Location: TERWILLIGAR DR STAGE 2
 Your P.O. #: 2021-3981.001-140
 Sampler Initials: RH

AT1 BTEX AND F1-F4 IN SOIL (VIALS)

BV Labs ID		ZY0027		ZY0044	ZY0047		
Sampling Date		2021/06/03		2021/06/03	2021/06/03		
COC Number		637640-01-01		637640-02-01	637640-02-01		
	UNITS	21HA05 (0.0-0.3M)	QC Batch	21HA06 (0.0-0.3M)	21HA07 (0.6-1.0M)	RDL	QC Batch
Ext. Pet. Hydrocarbon							
F2 (C10-C16 Hydrocarbons)	mg/kg	<10	A251226	<10	<10	10	A251730
F3 (C16-C34 Hydrocarbons)	mg/kg	67	A251226	72	<50	50	A251730
F4 (C34-C50 Hydrocarbons)	mg/kg	68	A251226	<50	<50	50	A251730
Reached Baseline at C50	mg/kg	Yes	A251226	Yes	Yes		A251730
Physical Properties							
Moisture	%	12	A251762	16	8.7	0.30	A251762
Volatiles							
Xylenes (Total)	mg/kg	<0.045	A249298	<0.045	<0.045	0.045	A249298
F1 (C6-C10) - BTEX	mg/kg	<10	A249298	<10	<10	10	A249298
Field Preserved Volatiles							
Benzene	mg/kg	<0.0050	A250930	<0.0050	<0.0050	0.0050	A250930
Toluene	mg/kg	<0.050	A250930	<0.050	<0.050	0.050	A250930
Ethylbenzene	mg/kg	<0.010	A250930	<0.010	<0.010	0.010	A250930
m & p-Xylene	mg/kg	<0.040	A250930	<0.040	<0.040	0.040	A250930
o-Xylene	mg/kg	<0.020	A250930	<0.020	<0.020	0.020	A250930
F1 (C6-C10)	mg/kg	<10	A250930	<10	<10	10	A250930
Surrogate Recovery (%)							
1,4-Difluorobenzene (sur.)	%	95	A250930	94	95		A250930
4-Bromofluorobenzene (sur.)	%	111	A250930	107	109		A250930
D10-o-Xylene (sur.)	%	125	A250930	114	123		A250930
D4-1,2-Dichloroethane (sur.)	%	107	A250930	105	109		A250930
O-TERPHENYL (sur.)	%	95	A251226	101	90		A251730
RDL = Reportable Detection Limit							



BV Labs Job #: C138809
 Report Date: 2021/06/18

ASSOCIATED ENGINEERING ALBERTA LTD.
 Client Project #: 2021-3981.001.140
 Site Location: TERWILLIGAR DR STAGE 2
 Your P.O. #: 2021-3981.001-140
 Sampler Initials: RH

AT1 BTEX AND F1-F4 IN SOIL (VIALS)

BV Labs ID		ZY0048		ZY0050		ZY0052		
Sampling Date		2021/06/03		2021/06/03		2021/06/03		
COC Number		637640-02-01		637640-02-01		637640-02-01		
	UNITS	21HA08 (0.0-0.3M)	QC Batch	21HA09 (0.0-0.3M)	QC Batch	21HA10 (0.0-0.3M)	RDL	QC Batch
Ext. Pet. Hydrocarbon								
F2 (C10-C16 Hydrocarbons)	mg/kg	<10	A251730	<10	A251730	<10	10	A251226
F3 (C16-C34 Hydrocarbons)	mg/kg	61	A251730	82	A251730	180	50	A251226
F4 (C34-C50 Hydrocarbons)	mg/kg	<50	A251730	58	A251730	200	50	A251226
Reached Baseline at C50	mg/kg	Yes	A251730	Yes	A251730	Yes		A251226
Physical Properties								
Moisture	%	22	A251760	20	A251762	9.9	0.30	A251762
Volatiles								
Xylenes (Total)	mg/kg	<0.045	A249298	<0.045	A249298	<0.045	0.045	A249298
F1 (C6-C10) - BTEX	mg/kg	<10	A249298	<10	A249298	<10	10	A249298
Field Preserved Volatiles								
Benzene	mg/kg	<0.0050	A250930	<0.0050	A250930	<0.0050	0.0050	A250930
Toluene	mg/kg	<0.050	A250930	<0.050	A250930	<0.050	0.050	A250930
Ethylbenzene	mg/kg	<0.010	A250930	<0.010	A250930	<0.010	0.010	A250930
m & p-Xylene	mg/kg	<0.040	A250930	<0.040	A250930	<0.040	0.040	A250930
o-Xylene	mg/kg	<0.020	A250930	<0.020	A250930	<0.020	0.020	A250930
F1 (C6-C10)	mg/kg	<10	A250930	<10	A250930	<10	10	A250930
Surrogate Recovery (%)								
1,4-Difluorobenzene (sur.)	%	97	A250930	94	A250930	85		A250930
4-Bromofluorobenzene (sur.)	%	103	A250930	103	A250930	109		A250930
D10-o-Xylene (sur.)	%	124	A250930	126	A250930	109		A250930
D4-1,2-Dichloroethane (sur.)	%	103	A250930	106	A250930	136		A250930
O-TERPHENYL (sur.)	%	90	A251730	89	A251730	96		A251226
RDL = Reportable Detection Limit								



BV Labs Job #: C138809
 Report Date: 2021/06/18

ASSOCIATED ENGINEERING ALBERTA LTD.
 Client Project #: 2021-3981.001.140
 Site Location: TERWILLIGAR DR STAGE 2
 Your P.O. #: 2021-3981.001-140
 Sampler Initials: RH

AT1 BTEX AND F1-F4 IN SOIL (VIALS)

BV Labs ID		ZY0054		ZY0056	ZY0064		
Sampling Date		2021/06/03		2021/06/03	2021/06/04		
COC Number		637640-03-01		637640-03-01	637640-04-01		
	UNITS	21HA11 (0.0-0.3M)	QC Batch	21HA12 (0.0-0.3M)	21HA16 (0.0-0.3M)	RDL	QC Batch
Ext. Pet. Hydrocarbon							
F2 (C10-C16 Hydrocarbons)	mg/kg	<10	A251730	<10	<10	10	A251226
F3 (C16-C34 Hydrocarbons)	mg/kg	110	A251730	120	63	50	A251226
F4 (C34-C50 Hydrocarbons)	mg/kg	54	A251730	78	<50	50	A251226
Reached Baseline at C50	mg/kg	Yes	A251730	Yes	Yes		A251226
Physical Properties							
Moisture	%	16	A251760	15	16	0.30	A251760
Volatiles							
Xylenes (Total)	mg/kg	<0.045	A250352	<0.045	<0.045	0.045	A250352
F1 (C6-C10) - BTEX	mg/kg	<10	A250352	<10	<10	10	A250352
Field Preserved Volatiles							
Benzene	mg/kg	<0.0050	A250930	<0.0050	<0.0050	0.0050	A250930
Toluene	mg/kg	<0.050	A250930	<0.050	<0.050	0.050	A250930
Ethylbenzene	mg/kg	<0.010	A250930	<0.010	<0.010	0.010	A250930
m & p-Xylene	mg/kg	<0.040	A250930	<0.040	<0.040	0.040	A250930
o-Xylene	mg/kg	<0.020	A250930	<0.020	<0.020	0.020	A250930
F1 (C6-C10)	mg/kg	<10	A250930	<10	<10	10	A250930
Surrogate Recovery (%)							
1,4-Difluorobenzene (sur.)	%	95	A250930	95	95		A250930
4-Bromofluorobenzene (sur.)	%	109	A250930	106	108		A250930
D10-o-Xylene (sur.)	%	126	A250930	118	124		A250930
D4-1,2-Dichloroethane (sur.)	%	107	A250930	108	106		A250930
O-TERPHENYL (sur.)	%	99	A251730	94	100		A251226
RDL = Reportable Detection Limit							



BV Labs Job #: C138809
Report Date: 2021/06/18

ASSOCIATED ENGINEERING ALBERTA LTD.
Client Project #: 2021-3981.001.140
Site Location: TERWILLIGAR DR STAGE 2
Your P.O. #: 2021-3981.001-140
Sampler Initials: RH

AT1 BTEX AND F1-F4 IN SOIL (VIALS)

BV Labs ID		ZY0066		ZY0068		ZY0070		
Sampling Date		2021/06/04		2021/06/03		2021/06/04		
COC Number		637640-04-01		637640-04-01		637640-04-01		
	UNITS	21HA17 (0.0-0.3M)	QC Batch	21HA18 (0.0-0.3M)	QC Batch	21HA19 (0.0-0.3M)	RDL	QC Batch
Ext. Pet. Hydrocarbon								
F2 (C10-C16 Hydrocarbons)	mg/kg	<10	A251226	<10	A251730	<10	10	A251226
F3 (C16-C34 Hydrocarbons)	mg/kg	73	A251226	76	A251730	97	50	A251226
F4 (C34-C50 Hydrocarbons)	mg/kg	<50	A251226	<50	A251730	58	50	A251226
Reached Baseline at C50	mg/kg	Yes	A251226	Yes	A251730	Yes		A251226
Physical Properties								
Moisture	%	23	A251761	20	A251760	19	0.30	A251761
Volatiles								
Xylenes (Total)	mg/kg	<0.045	A250352	<0.045	A250352	<0.045	0.045	A250352
F1 (C6-C10) - BTEX	mg/kg	<10	A250352	<10	A250352	<10	10	A250352
Field Preserved Volatiles								
Benzene	mg/kg	<0.0050	A250930	<0.0050	A250930	<0.0050	0.0050	A250930
Toluene	mg/kg	<0.050	A250930	<0.050	A250930	<0.050	0.050	A250930
Ethylbenzene	mg/kg	<0.010	A250930	<0.010	A250930	<0.010	0.010	A250930
m & p-Xylene	mg/kg	<0.040	A250930	<0.040	A250930	<0.040	0.040	A250930
o-Xylene	mg/kg	<0.020	A250930	<0.020	A250930	<0.020	0.020	A250930
F1 (C6-C10)	mg/kg	<10	A250930	<10	A250930	<10	10	A250930
Surrogate Recovery (%)								
1,4-Difluorobenzene (sur.)	%	98	A250930	95	A250930	96		A250930
4-Bromofluorobenzene (sur.)	%	109	A250930	101	A250930	110		A250930
D10-o-Xylene (sur.)	%	130	A250930	110	A250930	115		A250930
D4-1,2-Dichloroethane (sur.)	%	112	A250930	106	A250930	110		A250930
O-TERPHENYL (sur.)	%	94	A251226	109	A251730	96		A251226
RDL = Reportable Detection Limit								



BV Labs Job #: C138809
 Report Date: 2021/06/18

ASSOCIATED ENGINEERING ALBERTA LTD.
 Client Project #: 2021-3981.001.140
 Site Location: TERWILLIGAR DR STAGE 2
 Your P.O. #: 2021-3981.001-140
 Sampler Initials: RH

AT1 BTEX AND F1-F4 IN SOIL (VIALS)

BV Labs ID		ZY0073	ZY0074		ZY0076		
Sampling Date		2021/06/03	2021/06/02		2021/06/02		
COC Number		637640-04-01	637640-05-01		637640-05-01		
	UNITS	21HA20 (0.6-1.0M)	21HA21 (0.0-0.3M)	QC Batch	21HA22 (0.0-0.3M)	RDL	QC Batch
Ext. Pet. Hydrocarbon							
F2 (C10-C16 Hydrocarbons)	mg/kg	<10	<10	A251226	<10	10	A251730
F3 (C16-C34 Hydrocarbons)	mg/kg	91	78	A251226	67	50	A251730
F4 (C34-C50 Hydrocarbons)	mg/kg	62	62	A251226	<50	50	A251730
Reached Baseline at C50	mg/kg	Yes	Yes	A251226	Yes		A251730
Physical Properties							
Moisture	%	16	18	A251761	21	0.30	A251760
Volatiles							
Xylenes (Total)	mg/kg	<0.045	<0.045	A250352	<0.045	0.045	A250352
F1 (C6-C10) - BTEX	mg/kg	<10	<10	A250352	<10	10	A250352
Field Preserved Volatiles							
Benzene	mg/kg	<0.0050	<0.0050	A250930	<0.0050	0.0050	A250930
Toluene	mg/kg	<0.050	<0.050	A250930	<0.050	0.050	A250930
Ethylbenzene	mg/kg	<0.010	<0.010	A250930	<0.010	0.010	A250930
m & p-Xylene	mg/kg	<0.040	<0.040	A250930	<0.040	0.040	A250930
o-Xylene	mg/kg	<0.020	<0.020	A250930	<0.020	0.020	A250930
F1 (C6-C10)	mg/kg	<10	<10	A250930	<10	10	A250930
Surrogate Recovery (%)							
1,4-Difluorobenzene (sur.)	%	94	93	A250930	97		A250930
4-Bromofluorobenzene (sur.)	%	104	106	A250930	107		A250930
D10-o-Xylene (sur.)	%	134	123	A250930	129		A250930
D4-1,2-Dichloroethane (sur.)	%	110	107	A250930	109		A250930
O-TERPHENYL (sur.)	%	96	94	A251226	107		A251730
RDL = Reportable Detection Limit							



AT1 BTEX AND F1-F4 IN SOIL (VIALS)

BV Labs ID		ZY0078		ZY0080		ZY0082		
Sampling Date		2021/06/02		2021/06/02		2021/06/02		
COC Number		637640-05-01		637640-05-01		637640-05-01		
	UNITS	21HA23 (0.0-0.3M)	QC Batch	21HA24 (0.0-0.3M)	QC Batch	21HA25 (0.0-0.3M)	RDL	QC Batch
Ext. Pet. Hydrocarbon								
F2 (C10-C16 Hydrocarbons)	mg/kg	<10	A251226	<10	A251226	<10	10	A251730
F3 (C16-C34 Hydrocarbons)	mg/kg	<50	A251226	450	A251226	83	50	A251730
F4 (C34-C50 Hydrocarbons)	mg/kg	<50	A251226	760	A251226	56	50	A251730
Reached Baseline at C50	mg/kg	Yes	A251226	No	A251226	Yes		A251730
Physical Properties								
Moisture	%	23	A251760	16	A251761	22	0.30	A251760
Volatiles								
Xylenes (Total)	mg/kg	<0.045	A250352	<0.045	A250352	<0.045	0.045	A250352
F1 (C6-C10) - BTEX	mg/kg	<10	A250352	<10	A250352	<10	10	A250352
Field Preserved Volatiles								
Benzene	mg/kg	<0.0050	A250930	<0.0050	A250944	<0.0050	0.0050	A250944
Toluene	mg/kg	<0.050	A250930	<0.050	A250944	<0.050	0.050	A250944
Ethylbenzene	mg/kg	<0.010	A250930	<0.010	A250944	<0.010	0.010	A250944
m & p-Xylene	mg/kg	<0.040	A250930	<0.040	A250944	<0.040	0.040	A250944
o-Xylene	mg/kg	<0.020	A250930	<0.020	A250944	<0.020	0.020	A250944
F1 (C6-C10)	mg/kg	<10	A250930	<10	A250944	<10	10	A250944
Surrogate Recovery (%)								
1,4-Difluorobenzene (sur.)	%	94	A250930	96	A250944	94		A250944
4-Bromofluorobenzene (sur.)	%	107	A250930	101	A250944	102		A250944
D10-o-Xylene (sur.)	%	120	A250930	120	A250944	138		A250944
D4-1,2-Dichloroethane (sur.)	%	105	A250930	106	A250944	110		A250944
O-TERPHENYL (sur.)	%	98	A251226	89	A251226	107		A251730
RDL = Reportable Detection Limit								



AT1 BTEX AND F1-F4 IN SOIL (VIALS)

BV Labs ID		ZY0085	ZY0087		ZY0088		
Sampling Date		2021/06/02	2021/06/02		2021/06/02		
COC Number		637640-06-01	637640-06-01		637640-06-01		
	UNITS	21HA26 (0.6-1.0M)	21HA27 (0.6-1.0M)	QC Batch	21HA28 (0.0-0.3M)	RDL	QC Batch
Ext. Pet. Hydrocarbon							
F2 (C10-C16 Hydrocarbons)	mg/kg	<10	<10	A251226	<10	10	A251730
F3 (C16-C34 Hydrocarbons)	mg/kg	68	<50	A251226	150	50	A251730
F4 (C34-C50 Hydrocarbons)	mg/kg	<50	<50	A251226	130	50	A251730
Reached Baseline at C50	mg/kg	Yes	Yes	A251226	Yes		A251730
Physical Properties							
Moisture	%	26	22	A251760	20	0.30	A251762
Volatiles							
Xylenes (Total)	mg/kg	<0.045	<0.045	A250352	<0.045	0.045	A250352
F1 (C6-C10) - BTEX	mg/kg	<10	<10	A250352	<10	10	A250352
Field Preserved Volatiles							
Benzene	mg/kg	<0.0050	<0.0050	A250944	<0.0050	0.0050	A252324
Toluene	mg/kg	<0.050	<0.050	A250944	<0.050	0.050	A252324
Ethylbenzene	mg/kg	<0.010	<0.010	A250944	<0.010	0.010	A252324
m & p-Xylene	mg/kg	<0.040	<0.040	A250944	<0.040	0.040	A252324
o-Xylene	mg/kg	<0.020	<0.020	A250944	<0.020	0.020	A252324
F1 (C6-C10)	mg/kg	<10	<10	A250944	<10	10	A252324
Surrogate Recovery (%)							
1,4-Difluorobenzene (sur.)	%	97	94	A250944	94		A252324
4-Bromofluorobenzene (sur.)	%	101	101	A250944	103		A252324
D10-o-Xylene (sur.)	%	145 (1)	122	A250944	132		A252324
D4-1,2-Dichloroethane (sur.)	%	103	104	A250944	106		A252324
O-TERPHENYL (sur.)	%	98	88	A251226	104		A251730
RDL = Reportable Detection Limit							
(1) Surrogate recovery exceeds acceptance criteria (high recovery). As results are non-detect, there is no impact on data quality.							



AT1 BTEX AND F1-F4 IN SOIL (VIALS)

BV Labs ID		ZY0090		ZY0093		ZY0094	ZY0095		
Sampling Date		2021/06/02		2021/06/02		2021/06/02	2021/06/02		
COC Number		637640-06-01		637640-06-01		637640-07-01	637640-07-01		
	UNITS	21HA29 (0.0-0.3M)	QC Batch	21HA30 (0.6-1.0M)	QC Batch	DUP 1	DUP 2	RDL	QC Batch
Ext. Pet. Hydrocarbon									
F2 (C10-C16 Hydrocarbons)	mg/kg	<10	A251730	<10	A251226	<10	<10	10	A251730
F3 (C16-C34 Hydrocarbons)	mg/kg	100	A251730	<50	A251226	<50	82	50	A251730
F4 (C34-C50 Hydrocarbons)	mg/kg	63	A251730	<50	A251226	<50	<50	50	A251730
Reached Baseline at C50	mg/kg	Yes	A251730	Yes	A251226	Yes	Yes		A251730
Physical Properties									
Moisture	%	21	A251760	14	A251760	21	27	0.30	A251762
Volatiles									
Xylenes (Total)	mg/kg	<0.045	A250352	<0.045	A250352	<0.045	<0.045	0.045	A250352
F1 (C6-C10) - BTEX	mg/kg	<10	A250352	<10	A250352	<10	<10	10	A250352
Field Preserved Volatiles									
Benzene	mg/kg	<0.0050	A250944	<0.0050	A250944	<0.0050	<0.0050	0.0050	A250944
Toluene	mg/kg	<0.050	A250944	<0.050	A250944	<0.050	<0.050	0.050	A250944
Ethylbenzene	mg/kg	<0.010	A250944	<0.010	A250944	<0.010	<0.010	0.010	A250944
m & p-Xylene	mg/kg	<0.040	A250944	<0.040	A250944	<0.040	<0.040	0.040	A250944
o-Xylene	mg/kg	<0.020	A250944	<0.020	A250944	<0.020	<0.020	0.020	A250944
F1 (C6-C10)	mg/kg	<10	A250944	<10	A250944	<10	<10	10	A250944
Surrogate Recovery (%)									
1,4-Difluorobenzene (sur.)	%	95	A250944	94	A250944	89	104		A250944
4-Bromofluorobenzene (sur.)	%	102	A250944	103	A250944	104	99		A250944
D10-o-Xylene (sur.)	%	136	A250944	124	A250944	160 (1)	117		A250944
D4-1,2-Dichloroethane (sur.)	%	106	A250944	107	A250944	119	98		A250944
O-TERPHENYL (sur.)	%	94	A251730	87	A251226	93	89		A251730
RDL = Reportable Detection Limit									
(1) Surrogate recovery exceeds acceptance criteria (high recovery). As results are non-detect, there is no impact on data quality.									



BV Labs Job #: C138809
Report Date: 2021/06/18

ASSOCIATED ENGINEERING ALBERTA LTD.
Client Project #: 2021-3981.001.140
Site Location: TERWILLIGAR DR STAGE 2
Your P.O. #: 2021-3981.001-140
Sampler Initials: RH

AT1 BTEX AND F1-F4 IN SOIL (VIALS)

BV Labs ID		ZY0096		
Sampling Date		2021/06/02		
COC Number		637640-07-01		
	UNITS	DUP 3	RDL	QC Batch
Ext. Pet. Hydrocarbon				
F2 (C10-C16 Hydrocarbons)	mg/kg	<10	10	A251730
F3 (C16-C34 Hydrocarbons)	mg/kg	62	50	A251730
F4 (C34-C50 Hydrocarbons)	mg/kg	<50	50	A251730
Reached Baseline at C50	mg/kg	Yes		A251730
Physical Properties				
Moisture	%	19	0.30	A251760
Volatiles				
Xylenes (Total)	mg/kg	<0.045	0.045	A250352
F1 (C6-C10) - BTEX	mg/kg	<10	10	A250352
Field Preserved Volatiles				
Benzene	mg/kg	<0.0050	0.0050	A250944
Toluene	mg/kg	<0.050	0.050	A250944
Ethylbenzene	mg/kg	<0.010	0.010	A250944
m & p-Xylene	mg/kg	<0.040	0.040	A250944
o-Xylene	mg/kg	<0.020	0.020	A250944
F1 (C6-C10)	mg/kg	<10	10	A250944
Surrogate Recovery (%)				
1,4-Difluorobenzene (sur.)	%	104		A250944
4-Bromofluorobenzene (sur.)	%	99		A250944
D10-o-Xylene (sur.)	%	120		A250944
D4-1,2-Dichloroethane (sur.)	%	99		A250944
O-TERPHENYL (sur.)	%	92		A251730
RDL = Reportable Detection Limit				



AT1 METALS & SALINITY IN SOIL (SOIL)

BV Labs ID		ZY0020			ZY0022		
Sampling Date		2021/06/02			2021/06/03		
COC Number		637640-01-01			637640-01-01		
	UNITS	21HA01 (0.6-1.0M)	RDL	QC Batch	21HA02 (0.6-1.0M)	RDL	QC Batch
Calculated Parameters							
Anion Sum	meq/L	120	N/A	A250356	110	N/A	A250356
Cation Sum	meq/L	120	N/A	A250356	110	N/A	A250356
Cation/EC Ratio	N/A	11	0.10	A250353	11	0.10	A250353
Calculated Calcium (Ca)	mg/kg	770	1.0	A250348	430	0.71	A250348
Calculated Magnesium (Mg)	mg/kg	170	0.68	A250348	83	0.47	A250348
Calculated Sodium (Na)	mg/kg	630	1.7	A250348	560	1.2	A250348
Calculated Potassium (K)	mg/kg	15	0.89	A250348	11	0.62	A250348
Calculated Boron (B)	mg/kg	<0.068	0.068	A250346	<0.047	0.047	A250346
Calculated Chloride (Cl)	mg/kg	2000	68	A250348	1200	47	A250348
Calculated Sulphate (SO4)	mg/kg	1000	3.4	A250348	940	2.4	A250348
Elements							
Hex. Chromium (Cr 6+)	mg/kg	<0.080	0.080	A252546	<0.080	0.080	A252546
Soluble Parameters							
Soluble Boron (B)	mg/L	<0.10	0.10	A253354	<0.10	0.10	A253422
Soluble Chloride (Cl)	mg/L	3000 (1)	100	A253394	2400 (1)	100	A253396
Soluble Conductivity	dS/m	11	0.020	A253586	9.9	0.020	A253467
Soluble (CaCl2) pH	pH	7.61	N/A	A252076	7.65	N/A	A252072
Sodium Adsorption Ratio	N/A	6.5	0.10	A250357	9.4	0.10	A250357
Soluble Calcium (Ca)	mg/L	1100	1.5	A253354	900	1.5	A253422
Soluble Magnesium (Mg)	mg/L	240	1.0	A253354	180	1.0	A253422
Soluble Sodium (Na)	mg/L	930	2.5	A253354	1200	2.5	A253422
Soluble Potassium (K)	mg/L	22	1.3	A253354	22	1.3	A253422
Saturation %	%	68	N/A	A252074	47	N/A	A252069
Soluble Sulphate (SO4)	mg/L	1500	5.0	A253354	2000	5.0	A253422
Theoretical Gypsum Requirement	tonnes/ha	14	0.20	A250349	21	0.20	A250349
Elements							
Total Antimony (Sb)	mg/kg	<0.50	0.50	A252581	<0.50	0.50	A252785
Total Arsenic (As)	mg/kg	10	1.0	A252581	7.4	1.0	A252785
Total Barium (Ba)	mg/kg	220	1.0	A252581	180	1.0	A252785
Total Beryllium (Be)	mg/kg	0.82	0.40	A252581	0.52	0.40	A252785
RDL = Reportable Detection Limit N/A = Not Applicable (1) Detection limits raised due to dilution to bring analyte within the calibrated range.							



BV Labs Job #: C138809
 Report Date: 2021/06/18

ASSOCIATED ENGINEERING ALBERTA LTD.
 Client Project #: 2021-3981.001.140
 Site Location: TERWILLIGAR DR STAGE 2
 Your P.O. #: 2021-3981.001-140
 Sampler Initials: RH

AT1 METALS & SALINITY IN SOIL (SOIL)

BV Labs ID		ZY0020			ZY0022		
Sampling Date		2021/06/02			2021/06/03		
COC Number		637640-01-01			637640-01-01		
	UNITS	21HA01 (0.6-1.0M)	RDL	QC Batch	21HA02 (0.6-1.0M)	RDL	QC Batch
Total Cadmium (Cd)	mg/kg	0.34	0.050	A252581	0.22	0.050	A252785
Total Chromium (Cr)	mg/kg	25	1.0	A252581	28	1.0	A252785
Total Cobalt (Co)	mg/kg	12	0.50	A252581	9.1	0.50	A252785
Total Copper (Cu)	mg/kg	31	1.0	A252581	17	1.0	A252785
Total Lead (Pb)	mg/kg	13	0.50	A252581	9.8	0.50	A252785
Total Mercury (Hg)	mg/kg	0.057	0.050	A252581	<0.050	0.050	A252785
Total Molybdenum (Mo)	mg/kg	1.3	0.40	A252581	1.1	0.40	A252785
Total Nickel (Ni)	mg/kg	34	1.0	A252581	28	1.0	A252785
Total Selenium (Se)	mg/kg	<0.50	0.50	A252581	0.59	0.50	A252785
Total Silver (Ag)	mg/kg	<0.20	0.20	A252581	<0.20	0.20	A252785
Total Thallium (Tl)	mg/kg	0.25	0.10	A252581	0.17	0.10	A252785
Total Tin (Sn)	mg/kg	<1.0	1.0	A252581	<1.0	1.0	A252785
Total Uranium (U)	mg/kg	1.1	0.20	A252581	1.0	0.20	A252785
Total Vanadium (V)	mg/kg	35	1.0	A252581	28	1.0	A252785
Total Zinc (Zn)	mg/kg	91	10	A252581	62	10	A252785
RDL = Reportable Detection Limit							



AT1 METALS & SALINITY IN SOIL (SOIL)

BV Labs ID		ZY0024			ZY0025		
Sampling Date		2021/06/03			2021/06/02		
COC Number		637640-01-01			637640-01-01		
	UNITS	21HA03 (0.6-1.0M)	RDL	QC Batch	21HA04 (0.0-0.3M)	RDL	QC Batch
Calculated Parameters							
Anion Sum	meq/L	63	N/A	A250356	10	N/A	A250356
Cation Sum	meq/L	60	N/A	A250356	17	N/A	A250356
Cation/EC Ratio	N/A	8.9	0.10	A250353	10	0.10	A250353
Calculated Calcium (Ca)	mg/kg	230	1.1	A250348	14	0.69	A250348
Calculated Magnesium (Mg)	mg/kg	43	0.70	A250348	1.8	0.46	A250348
Calculated Sodium (Na)	mg/kg	630	1.8	A250348	160	1.1	A250348
Calculated Potassium (K)	mg/kg	3.9	0.91	A250348	1.7	0.60	A250348
Calculated Boron (B)	mg/kg	<0.070	0.070	A250346	<0.046	0.046	A250346
Calculated Chloride (Cl)	mg/kg	1500	70	A250348	140	4.6	A250348
Calculated Sulphate (SO4)	mg/kg	88	3.5	A250348	42	2.3	A250348
Elements							
Hex. Chromium (Cr 6+)	mg/kg	<0.080	0.080	A253026	<0.080	0.080	A252964
Soluble Parameters							
Soluble Boron (B)	mg/L	<0.10	0.10	A253423	<0.10	0.10	A253423
Soluble Chloride (Cl)	mg/L	2100 (1)	100	A253395	300	10	A253395
Soluble Conductivity	dS/m	6.8	0.020	A253565	1.6	0.020	A253565
Soluble (CaCl2) pH	pH	7.70	N/A	A252145	7.82	N/A	A252145
Sodium Adsorption Ratio	N/A	12	0.10	A250357	16	0.10	A250357
Soluble Calcium (Ca)	mg/L	320	1.5	A253423	30	1.5	A253423
Soluble Magnesium (Mg)	mg/L	62	1.0	A253423	4.0	1.0	A253423
Soluble Sodium (Na)	mg/L	900	2.5	A253423	340	2.5	A253423
Soluble Potassium (K)	mg/L	5.6	1.3	A253423	3.6	1.3	A253423
Saturation %	%	70	N/A	A252137	46	N/A	A252137
Soluble Sulphate (SO4)	mg/L	130	5.0	A253423	92	5.0	A253423
Theoretical Gypsum Requirement	tonnes/ha	20	0.20	A250349	2.0	0.20	A250349
Elements							
Total Antimony (Sb)	mg/kg	<0.50	0.50	A252857	<0.50	0.50	A252857
Total Arsenic (As)	mg/kg	8.1	1.0	A252857	5.5	1.0	A252857
Total Barium (Ba)	mg/kg	220	1.0	A252857	170	1.0	A252857
Total Beryllium (Be)	mg/kg	0.89	0.40	A252857	0.59	0.40	A252857
RDL = Reportable Detection Limit N/A = Not Applicable (1) Detection limits raised due to dilution to bring analyte within the calibrated range.							



BV Labs Job #: C138809
 Report Date: 2021/06/18

ASSOCIATED ENGINEERING ALBERTA LTD.
 Client Project #: 2021-3981.001.140
 Site Location: TERWILLIGAR DR STAGE 2
 Your P.O. #: 2021-3981.001-140
 Sampler Initials: RH

AT1 METALS & SALINITY IN SOIL (SOIL)

BV Labs ID		ZY0024			ZY0025		
Sampling Date		2021/06/03			2021/06/02		
COC Number		637640-01-01			637640-01-01		
	UNITS	21HA03 (0.6-1.0M)	RDL	QC Batch	21HA04 (0.0-0.3M)	RDL	QC Batch
Total Cadmium (Cd)	mg/kg	0.23	0.050	A252857	0.17	0.050	A252857
Total Chromium (Cr)	mg/kg	30	1.0	A252857	60	1.0	A252857
Total Cobalt (Co)	mg/kg	12	0.50	A252857	8.7	0.50	A252857
Total Copper (Cu)	mg/kg	26	1.0	A252857	17	1.0	A252857
Total Lead (Pb)	mg/kg	14	0.50	A252857	10	0.50	A252857
Total Mercury (Hg)	mg/kg	0.050	0.050	A252857	<0.050	0.050	A252857
Total Molybdenum (Mo)	mg/kg	1.0	0.40	A252857	1.6	0.40	A252857
Total Nickel (Ni)	mg/kg	34	1.0	A252857	41	1.0	A252857
Total Selenium (Se)	mg/kg	<0.50	0.50	A252857	<0.50	0.50	A252857
Total Silver (Ag)	mg/kg	<0.20	0.20	A252857	<0.20	0.20	A252857
Total Thallium (Tl)	mg/kg	0.21	0.10	A252857	0.12	0.10	A252857
Total Tin (Sn)	mg/kg	<1.0	1.0	A252857	<1.0	1.0	A252857
Total Uranium (U)	mg/kg	0.99	0.20	A252857	1.2	0.20	A252857
Total Vanadium (V)	mg/kg	42	1.0	A252857	30	1.0	A252857
Total Zinc (Zn)	mg/kg	77	10	A252857	63	10	A252857
RDL = Reportable Detection Limit							



AT1 METALS & SALINITY IN SOIL (SOIL)

BV Labs ID		ZY0028			ZY0044		
Sampling Date		2021/06/03			2021/06/03		
COC Number		637640-01-01			637640-02-01		
	UNITS	21HA05 (0.6-1.0M)	RDL	QC Batch	21HA06 (0.0-0.3M)	RDL	QC Batch
Calculated Parameters							
Anion Sum	meq/L	100	N/A	A250356	31	N/A	A250356
Cation Sum	meq/L	100	N/A	A250356	36	N/A	A250356
Cation/EC Ratio	N/A	9.6	0.10	A250353	13	0.10	A250353
Calculated Calcium (Ca)	mg/kg	160	0.85	A250348	22	0.78	A250348
Calculated Magnesium (Mg)	mg/kg	21	0.57	A250348	2.5	0.52	A250348
Calculated Sodium (Na)	mg/kg	1100	1.4	A250348	400	1.3	A250348
Calculated Potassium (K)	mg/kg	11	0.74	A250348	7.3	0.68	A250348
Calculated Boron (B)	mg/kg	<0.057	0.057	A250346	0.057	0.052	A250346
Calculated Chloride (Cl)	mg/kg	1800	57	A250348	540	26	A250348
Calculated Sulphate (SO4)	mg/kg	390	2.8	A250348	39	2.6	A250348
Elements							
Hex. Chromium (Cr 6+)	mg/kg	<0.080	0.080	A252546	<0.080	0.080	A252546
Soluble Parameters							
Soluble Boron (B)	mg/L	<0.10	0.10	A253354	0.11	0.10	A253423
Soluble Chloride (Cl)	mg/L	3200 (1)	100	A253394	1000 (1)	50	A253395
Soluble Conductivity	dS/m	11	0.020	A253586	2.8	0.020	A253565
Soluble (CaCl2) pH	pH	7.93	N/A	A252076	7.72	N/A	A252145
Sodium Adsorption Ratio	N/A	30	0.10	A250357	30	0.10	A250357
Soluble Calcium (Ca)	mg/L	280	1.5	A253354	42	1.5	A253423
Soluble Magnesium (Mg)	mg/L	36	1.0	A253354	4.8	1.0	A253423
Soluble Sodium (Na)	mg/L	2000	2.5	A253354	760	2.5	A253423
Soluble Potassium (K)	mg/L	19	1.3	A253354	14	1.3	A253423
Saturation %	%	57	N/A	A252074	52	N/A	A252137
Soluble Sulphate (SO4)	mg/L	690	5.0	A253354	74	5.0	A253423
Theoretical Gypsum Requirement	tonnes/ha	89	0.20	A250349	12	0.20	A250349
Elements							
Total Antimony (Sb)	mg/kg	<0.50	0.50	A252581	<0.50	0.50	A252857
Total Arsenic (As)	mg/kg	7.0	1.0	A252581	6.0	1.0	A252857
Total Barium (Ba)	mg/kg	180	1.0	A252581	180	1.0	A252857
Total Beryllium (Be)	mg/kg	0.54	0.40	A252581	0.62	0.40	A252857
RDL = Reportable Detection Limit N/A = Not Applicable (1) Detection limits raised due to dilution to bring analyte within the calibrated range.							



BV Labs Job #: C138809
 Report Date: 2021/06/18

ASSOCIATED ENGINEERING ALBERTA LTD.
 Client Project #: 2021-3981.001.140
 Site Location: TERWILLIGAR DR STAGE 2
 Your P.O. #: 2021-3981.001-140
 Sampler Initials: RH

AT1 METALS & SALINITY IN SOIL (SOIL)

BV Labs ID		ZY0028			ZY0044		
Sampling Date		2021/06/03			2021/06/03		
COC Number		637640-01-01			637640-02-01		
	UNITS	21HA05 (0.6-1.0M)	RDL	QC Batch	21HA06 (0.0-0.3M)	RDL	QC Batch
Total Cadmium (Cd)	mg/kg	0.24	0.050	A252581	0.24	0.050	A252857
Total Chromium (Cr)	mg/kg	34	1.0	A252581	32	1.0	A252857
Total Cobalt (Co)	mg/kg	8.6	0.50	A252581	11	0.50	A252857
Total Copper (Cu)	mg/kg	19	1.0	A252581	19	1.0	A252857
Total Lead (Pb)	mg/kg	12	0.50	A252581	19	0.50	A252857
Total Mercury (Hg)	mg/kg	<0.050	0.050	A252581	<0.050	0.050	A252857
Total Molybdenum (Mo)	mg/kg	1.2	0.40	A252581	1.1	0.40	A252857
Total Nickel (Ni)	mg/kg	31	1.0	A252581	29	1.0	A252857
Total Selenium (Se)	mg/kg	<0.50	0.50	A252581	<0.50	0.50	A252857
Total Silver (Ag)	mg/kg	<0.20	0.20	A252581	<0.20	0.20	A252857
Total Thallium (Tl)	mg/kg	0.18	0.10	A252581	0.14	0.10	A252857
Total Tin (Sn)	mg/kg	<1.0	1.0	A252581	1.0	1.0	A252857
Total Uranium (U)	mg/kg	0.99	0.20	A252581	0.65	0.20	A252857
Total Vanadium (V)	mg/kg	28	1.0	A252581	35	1.0	A252857
Total Zinc (Zn)	mg/kg	64	10	A252581	86	10	A252857
RDL = Reportable Detection Limit							



BV Labs Job #: C138809
 Report Date: 2021/06/18

ASSOCIATED ENGINEERING ALBERTA LTD.
 Client Project #: 2021-3981.001.140
 Site Location: TERWILLIGAR DR STAGE 2
 Your P.O. #: 2021-3981.001-140
 Sampler Initials: RH

AT1 METALS & SALINITY IN SOIL (SOIL)

BV Labs ID		ZY0045			ZY0046		
Sampling Date		2021/06/03			2021/06/03		
COC Number		637640-02-01			637640-02-01		
	UNITS	21HA06 (0.6-1.0M)	RDL	QC Batch	21HA07 (0.0-0.3M)	RDL	QC Batch
Calculated Parameters							
Anion Sum	meq/L	140	N/A	A250213	36	N/A	A250213
Cation Sum	meq/L	140	N/A	A250213	41	N/A	A250213
Cation/EC Ratio	N/A	11	0.10	A250211	9.5	0.10	A250211
Calculated Calcium (Ca)	mg/kg	440	0.88	A250220	15	0.56	A250220
Calculated Magnesium (Mg)	mg/kg	39	0.59	A250220	1.4	0.37	A250220
Calculated Sodium (Na)	mg/kg	1300	1.5	A250220	330	0.93	A250220
Calculated Potassium (K)	mg/kg	11	0.76	A250220	4.6	0.48	A250220
Calculated Boron (B)	mg/kg	<0.059	0.059	A249392	0.058	0.037	A249392
Calculated Chloride (Cl)	mg/kg	1700	59	A250220	420	19	A250220
Calculated Sulphate (SO4)	mg/kg	1600	2.9	A250220	75	1.9	A250220
Elements							
Hex. Chromium (Cr 6+)	mg/kg	<0.080	0.080	A252546	<0.080	0.080	A252546
Soluble Parameters							
Soluble Boron (B)	mg/L	<0.10	0.10	A253422	0.16	0.10	A253422
Soluble Chloride (Cl)	mg/L	3000 (1)	100	A253396	1100 (1)	50	A253396
Soluble Conductivity	dS/m	13	0.020	A253467	4.3	0.020	A253467
Soluble (CaCl2) pH	pH	7.66	N/A	A252072	7.86	N/A	A252072
Sodium Adsorption Ratio	N/A	21	0.10	A250219	35	0.10	A250219
Soluble Calcium (Ca)	mg/L	740	1.5	A253422	42	1.5	A253422
Soluble Magnesium (Mg)	mg/L	67	1.0	A253422	3.7	1.0	A253422
Soluble Sodium (Na)	mg/L	2200	2.5	A253422	880	2.5	A253422
Soluble Potassium (K)	mg/L	18	1.3	A253422	12	1.3	A253422
Saturation %	%	59	N/A	A252069	37	N/A	A252069
Soluble Sulphate (SO4)	mg/L	2700	5.0	A253422	200	5.0	A253422
Theoretical Gypsum Requirement	tonnes/ha	110	0.20	A250222	11	0.20	A250222
Elements							
Total Antimony (Sb)	mg/kg	<0.50	0.50	A252581	<0.50	0.50	A252785
Total Arsenic (As)	mg/kg	9.4	1.0	A252581	5.2	1.0	A252785
Total Barium (Ba)	mg/kg	200	1.0	A252581	130	1.0	A252785
Total Beryllium (Be)	mg/kg	0.56	0.40	A252581	0.40	0.40	A252785
RDL = Reportable Detection Limit N/A = Not Applicable (1) Detection limits raised due to dilution to bring analyte within the calibrated range.							



BV Labs Job #: C138809
 Report Date: 2021/06/18

ASSOCIATED ENGINEERING ALBERTA LTD.
 Client Project #: 2021-3981.001.140
 Site Location: TERWILLIGAR DR STAGE 2
 Your P.O. #: 2021-3981.001-140
 Sampler Initials: RH

AT1 METALS & SALINITY IN SOIL (SOIL)

BV Labs ID		ZY0045			ZY0046		
Sampling Date		2021/06/03			2021/06/03		
COC Number		637640-02-01			637640-02-01		
	UNITS	21HA06 (0.6-1.0M)	RDL	QC Batch	21HA07 (0.0-0.3M)	RDL	QC Batch
Total Cadmium (Cd)	mg/kg	0.30	0.050	A252581	0.23	0.050	A252785
Total Chromium (Cr)	mg/kg	20	1.0	A252581	35	1.0	A252785
Total Cobalt (Co)	mg/kg	9.3	0.50	A252581	7.6	0.50	A252785
Total Copper (Cu)	mg/kg	23	1.0	A252581	16	1.0	A252785
Total Lead (Pb)	mg/kg	11	0.50	A252581	22	0.50	A252785
Total Mercury (Hg)	mg/kg	0.050	0.050	A252581	<0.050	0.050	A252785
Total Molybdenum (Mo)	mg/kg	1.1	0.40	A252581	1.2	0.40	A252785
Total Nickel (Ni)	mg/kg	26	1.0	A252581	27	1.0	A252785
Total Selenium (Se)	mg/kg	0.73	0.50	A252581	<0.50	0.50	A252785
Total Silver (Ag)	mg/kg	<0.20	0.20	A252581	<0.20	0.20	A252785
Total Thallium (Tl)	mg/kg	0.22	0.10	A252581	0.12	0.10	A252785
Total Tin (Sn)	mg/kg	<1.0	1.0	A252581	<1.0	1.0	A252785
Total Uranium (U)	mg/kg	1.0	0.20	A252581	0.55	0.20	A252785
Total Vanadium (V)	mg/kg	29	1.0	A252581	26	1.0	A252785
Total Zinc (Zn)	mg/kg	79	10	A252581	68	10	A252785
RDL = Reportable Detection Limit							



AT1 METALS & SALINITY IN SOIL (SOIL)

BV Labs ID		ZY0049			ZY0050		ZY0052		
Sampling Date		2021/06/03			2021/06/03		2021/06/03		
COC Number		637640-02-01			637640-02-01		637640-02-01		
	UNITS	21HA08 (0.6-1.0M)	RDL	QC Batch	21HA09 (0.0-0.3M)	RDL	21HA10 (0.0-0.3M)	RDL	QC Batch

Calculated Parameters									
Anion Sum	meq/L	79	N/A	A250213	19	N/A	54	N/A	A250213
Cation Sum	meq/L	74	N/A	A250213	27	N/A	60	N/A	A250213
Cation/EC Ratio	N/A	8.9	0.10	A250211	10	0.10	9.5	0.10	A250211
Calculated Calcium (Ca)	mg/kg	63	0.98	A250220	12	0.58	16	0.56	A250220
Calculated Magnesium (Mg)	mg/kg	15	0.65	A250220	1.4	0.38	1.8	0.38	A250220
Calculated Sodium (Na)	mg/kg	1000	1.6	A250220	220	0.96	490	0.94	A250220
Calculated Potassium (K)	mg/kg	5.5	0.85	A250220	3.9	0.50	5.0	0.49	A250220
Calculated Boron (B)	mg/kg	<0.065	0.065	A249392	0.047	0.038	0.056	0.038	A249392
Calculated Chloride (Cl)	mg/kg	1800	65	A250220	230	7.7	690	19	A250220
Calculated Sulphate (SO4)	mg/kg	77	3.3	A250220	37	1.9	36	1.9	A250220

Elements									
Hex. Chromium (Cr 6+)	mg/kg	<0.080	0.080	A252964	<0.080	0.080	<0.080	0.080	A252964

Soluble Parameters									
Soluble Boron (B)	mg/L	<0.10	0.10	A253354	0.12	0.10	0.15	0.10	A253422
Soluble Chloride (Cl)	mg/L	2700 (1)	100	A253394	600 (1)	20	1800 (1)	50	A253396
Soluble Conductivity	dS/m	8.4	0.020	A253586	2.7	0.020	6.3	0.020	A253467
Soluble (CaCl2) pH	pH	8.11	N/A	A252076	7.78	N/A	8.15	N/A	A252072
Sodium Adsorption Ratio	N/A	37	0.10	A250219	27	0.10	50	0.10	A250219
Soluble Calcium (Ca)	mg/L	96	1.5	A253354	30	1.5	43	1.5	A253422
Soluble Magnesium (Mg)	mg/L	23	1.0	A253354	3.7	1.0	4.7	1.0	A253422
Soluble Sodium (Na)	mg/L	1500	2.5	A253354	580	2.5	1300	2.5	A253422
Soluble Potassium (K)	mg/L	8.4	1.3	A253354	10	1.3	13	1.3	A253422
Saturation %	%	65	N/A	A252074	38	N/A	38	N/A	A252069
Soluble Sulphate (SO4)	mg/L	120	5.0	A253354	96	5.0	96	5.0	A253422
Theoretical Gypsum Requirement	tonnes/ha	61	0.20	A250222	5.1	0.20	25	0.20	A250222

Elements									
Total Antimony (Sb)	mg/kg	<0.50	0.50	A252581	<0.50	0.50	<0.50	0.50	A252785
Total Arsenic (As)	mg/kg	12	1.0	A252581	5.9	1.0	5.1	1.0	A252785
Total Barium (Ba)	mg/kg	210	1.0	A252581	180	1.0	140	1.0	A252785
Total Beryllium (Be)	mg/kg	0.64	0.40	A252581	0.60	0.40	0.48	0.40	A252785

RDL = Reportable Detection Limit

N/A = Not Applicable

(1) Detection limits raised due to dilution to bring analyte within the calibrated range.



BV Labs Job #: C138809
 Report Date: 2021/06/18

ASSOCIATED ENGINEERING ALBERTA LTD.
 Client Project #: 2021-3981.001.140
 Site Location: TERWILLIGAR DR STAGE 2
 Your P.O. #: 2021-3981.001-140
 Sampler Initials: RH

AT1 METALS & SALINITY IN SOIL (SOIL)

BV Labs ID		ZY0049			ZY0050		ZY0052		
Sampling Date		2021/06/03			2021/06/03		2021/06/03		
COC Number		637640-02-01			637640-02-01		637640-02-01		
	UNITS	21HA08 (0.6-1.0M)	RDL	QC Batch	21HA09 (0.0-0.3M)	RDL	21HA10 (0.0-0.3M)	RDL	QC Batch
Total Cadmium (Cd)	mg/kg	0.41	0.050	A252581	0.25	0.050	0.18	0.050	A252785
Total Chromium (Cr)	mg/kg	22	1.0	A252581	44	1.0	38	1.0	A252785
Total Cobalt (Co)	mg/kg	12	0.50	A252581	9.4	0.50	7.3	0.50	A252785
Total Copper (Cu)	mg/kg	29	1.0	A252581	20	1.0	16	1.0	A252785
Total Lead (Pb)	mg/kg	14	0.50	A252581	15	0.50	15	0.50	A252785
Total Mercury (Hg)	mg/kg	0.094	0.050	A252581	<0.050	0.050	<0.050	0.050	A252785
Total Molybdenum (Mo)	mg/kg	1.3	0.40	A252581	1.3	0.40	1.3	0.40	A252785
Total Nickel (Ni)	mg/kg	33	1.0	A252581	34	1.0	28	1.0	A252785
Total Selenium (Se)	mg/kg	2.9	0.50	A252581	<0.50	0.50	<0.50	0.50	A252785
Total Silver (Ag)	mg/kg	<0.20	0.20	A252581	<0.20	0.20	<0.20	0.20	A252785
Total Thallium (Tl)	mg/kg	0.24	0.10	A252581	0.16	0.10	0.15	0.10	A252785
Total Tin (Sn)	mg/kg	<1.0	1.0	A252581	<1.0	1.0	<1.0	1.0	A252785
Total Uranium (U)	mg/kg	1.1	0.20	A252581	0.74	0.20	0.63	0.20	A252785
Total Vanadium (V)	mg/kg	35	1.0	A252581	34	1.0	28	1.0	A252785
Total Zinc (Zn)	mg/kg	98	10	A252581	92	10	67	10	A252785
RDL = Reportable Detection Limit									



AT1 METALS & SALINITY IN SOIL (SOIL)

BV Labs ID		ZY0053			ZY0055		
Sampling Date		2021/06/03			2021/06/03		
COC Number		637640-02-01			637640-03-01		
	UNITS	21HA10 (0.6-1.0M)	RDL	QC Batch	21HA11 (0.6-1.0M)	RDL	QC Batch
Calculated Parameters							
Anion Sum	meq/L	43	N/A	A250213	120	N/A	A250213
Cation Sum	meq/L	43	N/A	A250213	120	N/A	A250213
Cation/EC Ratio	N/A	8.8	0.10	A250211	11	0.10	A250211
Calculated Calcium (Ca)	mg/kg	37	1.0	A250220	460	1.0	A250220
Calculated Magnesium (Mg)	mg/kg	6.7	0.70	A250220	130	0.67	A250220
Calculated Sodium (Na)	mg/kg	620	1.7	A250220	1100	1.7	A250220
Calculated Potassium (K)	mg/kg	4.2	0.91	A250220	22	0.88	A250220
Calculated Boron (B)	mg/kg	<0.070	0.070	A249392	<0.067	0.067	A249392
Calculated Chloride (Cl)	mg/kg	980	35	A250220	1800	67	A250220
Calculated Sulphate (SO4)	mg/kg	130	3.5	A250220	1500	3.4	A250220
Elements							
Hex. Chromium (Cr 6+)	mg/kg	<0.080	0.080	A252964	<0.080	0.080	A252964
Soluble Parameters							
Soluble Boron (B)	mg/L	<0.10	0.10	A253422	<0.10	0.10	A253354
Soluble Chloride (Cl)	mg/L	1400 (1)	50	A253396	2700 (1)	100	A253394
Soluble Conductivity	dS/m	4.8	0.020	A253467	11	0.020	A253586
Soluble (CaCl2) pH	pH	8.17	N/A	A252072	7.71	N/A	A252076
Sodium Adsorption Ratio	N/A	30	0.10	A250219	14	0.10	A250219
Soluble Calcium (Ca)	mg/L	53	1.5	A253422	680	1.5	A253354
Soluble Magnesium (Mg)	mg/L	9.6	1.0	A253422	190	1.0	A253354
Soluble Sodium (Na)	mg/L	890	2.5	A253422	1600	2.5	A253354
Soluble Potassium (K)	mg/L	6.0	1.3	A253422	33	1.3	A253354
Saturation %	%	70	N/A	A252069	67	N/A	A252074
Soluble Sulphate (SO4)	mg/L	180	5.0	A253422	2200	5.0	A253354
Theoretical Gypsum Requirement	tonnes/ha	22	0.20	A250222	59	0.20	A250222
Elements							
Total Antimony (Sb)	mg/kg	<0.50	0.50	A252785	0.52	0.50	A253314
Total Arsenic (As)	mg/kg	7.6	1.0	A252785	5.8	1.0	A253314
Total Barium (Ba)	mg/kg	210	1.0	A252785	280	1.0	A253314
Total Beryllium (Be)	mg/kg	0.69	0.40	A252785	0.77	0.40	A253314
RDL = Reportable Detection Limit N/A = Not Applicable (1) Detection limits raised due to dilution to bring analyte within the calibrated range.							



BV Labs Job #: C138809
 Report Date: 2021/06/18

ASSOCIATED ENGINEERING ALBERTA LTD.
 Client Project #: 2021-3981.001.140
 Site Location: TERWILLIGAR DR STAGE 2
 Your P.O. #: 2021-3981.001-140
 Sampler Initials: RH

AT1 METALS & SALINITY IN SOIL (SOIL)

BV Labs ID		ZY0053			ZY0055		
Sampling Date		2021/06/03			2021/06/03		
COC Number		637640-02-01			637640-03-01		
	UNITS	21HA10 (0.6-1.0M)	RDL	QC Batch	21HA11 (0.6-1.0M)	RDL	QC Batch
Total Cadmium (Cd)	mg/kg	0.25	0.050	A252785	0.32	0.050	A253314
Total Chromium (Cr)	mg/kg	28	1.0	A252785	23	1.0	A253314
Total Cobalt (Co)	mg/kg	11	0.50	A252785	12	0.50	A253314
Total Copper (Cu)	mg/kg	23	1.0	A252785	35	1.0	A253314
Total Lead (Pb)	mg/kg	12	0.50	A252785	12	0.50	A253314
Total Mercury (Hg)	mg/kg	<0.050	0.050	A252785	0.051	0.050	A253314
Total Molybdenum (Mo)	mg/kg	1.2	0.40	A252785	1.0	0.40	A253314
Total Nickel (Ni)	mg/kg	32	1.0	A252785	34	1.0	A253314
Total Selenium (Se)	mg/kg	<0.50	0.50	A252785	<0.50	0.50	A253314
Total Silver (Ag)	mg/kg	<0.20	0.20	A252785	<0.20	0.20	A253314
Total Thallium (Tl)	mg/kg	0.21	0.10	A252785	0.28	0.10	A253314
Total Tin (Sn)	mg/kg	<1.0	1.0	A252785	<1.0	1.0	A253314
Total Uranium (U)	mg/kg	1.0	0.20	A252785	1.9	0.20	A253314
Total Vanadium (V)	mg/kg	39	1.0	A252785	26	1.0	A253314
Total Zinc (Zn)	mg/kg	73	10	A252785	74	10	A253314
RDL = Reportable Detection Limit							



AT1 METALS & SALINITY IN SOIL (SOIL)

BV Labs ID		ZY0056			ZY0057		
Sampling Date		2021/06/03			2021/06/03		
COC Number		637640-03-01			637640-03-01		
	UNITS	21HA12 (0.0-0.3M)	RDL	QC Batch	21HA12 (0.6-1.0M)	RDL	QC Batch
Calculated Parameters							
Anion Sum	meq/L	130	N/A	A250213	86	N/A	A250213
Cation Sum	meq/L	130	N/A	A250213	93	N/A	A250213
Cation/EC Ratio	N/A	9.9	0.10	A250211	9.8	0.10	A250211
Calculated Calcium (Ca)	mg/kg	73	0.81	A250220	43	0.64	A250220
Calculated Magnesium (Mg)	mg/kg	7.5	0.54	A250220	4.6	0.43	A250220
Calculated Sodium (Na)	mg/kg	1600	1.4	A250220	850	1.1	A250220
Calculated Potassium (K)	mg/kg	13	0.71	A250220	6.8	0.56	A250220
Calculated Boron (B)	mg/kg	0.10	0.054	A249392	0.043	0.043	A249392
Calculated Chloride (Cl)	mg/kg	2400	110	A250220	1200	43	A250220
Calculated Sulphate (SO4)	mg/kg	57	2.7	A250220	93	2.1	A250220
Elements							
Hex. Chromium (Cr 6+)	mg/kg	<0.080	0.080	A252964	<0.080	0.080	A252964
Soluble Parameters							
Soluble Boron (B)	mg/L	0.19	0.10	A253354	0.10	0.10	A253423
Soluble Chloride (Cl)	mg/L	4400 (1)	200	A253394	2900 (1)	100	A253395
Soluble Conductivity	dS/m	14	0.020	A253586	9.5	0.020	A253565
Soluble (CaCl2) pH	pH	8.09	N/A	A252076	7.89	N/A	A252145
Sodium Adsorption Ratio	N/A	64	0.10	A250219	50	0.10	A250219
Soluble Calcium (Ca)	mg/L	130	1.5	A253354	100	1.5	A253423
Soluble Magnesium (Mg)	mg/L	14	1.0	A253354	11	1.0	A253423
Soluble Sodium (Na)	mg/L	2900	2.5	A253354	2000	2.5	A253423
Soluble Potassium (K)	mg/L	23	1.3	A253354	16	1.3	A253423
Saturation %	%	54	N/A	A252074	43	N/A	A252137
Soluble Sulphate (SO4)	mg/L	100	5.0	A253354	220	5.0	A253423
Theoretical Gypsum Requirement	tonnes/ha	180	0.20	A250222	66	0.20	A250222
Elements							
Total Antimony (Sb)	mg/kg	<0.50	0.50	A252581	<0.50	0.50	A252857
Total Arsenic (As)	mg/kg	5.8	1.0	A252581	5.8	1.0	A252857
Total Barium (Ba)	mg/kg	140	1.0	A252581	180	1.0	A252857
Total Beryllium (Be)	mg/kg	0.51	0.40	A252581	0.40	0.40	A252857
RDL = Reportable Detection Limit N/A = Not Applicable (1) Detection limits raised due to dilution to bring analyte within the calibrated range.							



BV Labs Job #: C138809
 Report Date: 2021/06/18

ASSOCIATED ENGINEERING ALBERTA LTD.
 Client Project #: 2021-3981.001.140
 Site Location: TERWILLIGAR DR STAGE 2
 Your P.O. #: 2021-3981.001-140
 Sampler Initials: RH

AT1 METALS & SALINITY IN SOIL (SOIL)

BV Labs ID		ZY0056			ZY0057		
Sampling Date		2021/06/03			2021/06/03		
COC Number		637640-03-01			637640-03-01		
	UNITS	21HA12 (0.0-0.3M)	RDL	QC Batch	21HA12 (0.6-1.0M)	RDL	QC Batch
Total Cadmium (Cd)	mg/kg	0.26	0.050	A252581	0.22	0.050	A252857
Total Chromium (Cr)	mg/kg	42	1.0	A252581	17	1.0	A252857
Total Cobalt (Co)	mg/kg	7.7	0.50	A252581	7.6	0.50	A252857
Total Copper (Cu)	mg/kg	22	1.0	A252581	13	1.0	A252857
Total Lead (Pb)	mg/kg	31	0.50	A252581	7.4	0.50	A252857
Total Mercury (Hg)	mg/kg	<0.050	0.050	A252581	<0.050	0.050	A252857
Total Molybdenum (Mo)	mg/kg	1.6	0.40	A252581	0.78	0.40	A252857
Total Nickel (Ni)	mg/kg	29	1.0	A252581	20	1.0	A252857
Total Selenium (Se)	mg/kg	<0.50	0.50	A252581	<0.50	0.50	A252857
Total Silver (Ag)	mg/kg	<0.20	0.20	A252581	<0.20	0.20	A252857
Total Thallium (Tl)	mg/kg	0.13	0.10	A252581	0.20	0.10	A252857
Total Tin (Sn)	mg/kg	1.1	1.0	A252581	<1.0	1.0	A252857
Total Uranium (U)	mg/kg	1.1	0.20	A252581	0.92	0.20	A252857
Total Vanadium (V)	mg/kg	29	1.0	A252581	20	1.0	A252857
Total Zinc (Zn)	mg/kg	82	10	A252581	47	10	A252857
RDL = Reportable Detection Limit							



AT1 METALS & SALINITY IN SOIL (SOIL)

BV Labs ID		ZY0064		ZY0065		ZY0066			
Sampling Date		2021/06/04		2021/06/04		2021/06/04			
COC Number		637640-04-01		637640-04-01		637640-04-01			
	UNITS	21HA16 (0.0-0.3M)	RDL	21HA16 (0.6-1.0M)	RDL	QC Batch	21HA17 (0.0-0.3M)	RDL	QC Batch

Calculated Parameters									
Anion Sum	meq/L	57	N/A	23	N/A	A250213	64	N/A	A250213
Cation Sum	meq/L	57	N/A	26	N/A	A250213	64	N/A	A250213
Cation/EC Ratio	N/A	8.9	0.10	9.2	0.10	A250211	9.2	0.10	A250353
Calculated Calcium (Ca)	mg/kg	77	0.91	38	0.96	A250220	150	0.93	A250348
Calculated Magnesium (Mg)	mg/kg	17	0.61	9.9	0.64	A250220	29	0.62	A250348
Calculated Sodium (Na)	mg/kg	660	1.5	310	1.6	A250220	680	1.5	A250348
Calculated Potassium (K)	mg/kg	19	0.79	8.6	0.83	A250220	5.0	0.80	A250348
Calculated Boron (B)	mg/kg	<0.061	0.061	<0.064	0.064	A249392	<0.062	0.062	A249392
Calculated Chloride (Cl)	mg/kg	1200	30	470	32	A250220	1400	62	A250348
Calculated Sulphate (SO4)	mg/kg	35	3.0	72	3.2	A250220	42	3.1	A250348

Elements									
Hex. Chromium (Cr 6+)	mg/kg	<0.080	0.080	<0.080	0.080	A252964	<0.080	0.080	A252964

Soluble Parameters									
Soluble Boron (B)	mg/L	<0.10	0.10	<0.10	0.10	A253422	<0.10	0.10	A253354
Soluble Chloride (Cl)	mg/L	2000 (1)	50	740 (1)	50	A253396	2200 (1)	100	A253394
Soluble Conductivity	dS/m	6.4	0.020	2.8	0.020	A253467	7.0	0.020	A253586
Soluble (CaCl2) pH	pH	7.86	N/A	7.86	N/A	A252072	7.61	N/A	A252076
Sodium Adsorption Ratio	N/A	23	0.10	14	0.10	A250219	17	0.10	A250219
Soluble Calcium (Ca)	mg/L	130	1.5	59	1.5	A253422	240	1.5	A253354
Soluble Magnesium (Mg)	mg/L	27	1.0	16	1.0	A253422	47	1.0	A253354
Soluble Sodium (Na)	mg/L	1100	2.5	480	2.5	A253422	1100	2.5	A253354
Soluble Potassium (K)	mg/L	32	1.3	14	1.3	A253422	8.1	1.3	A253354
Saturation %	%	61	N/A	64	N/A	A252069	62	N/A	A252074
Soluble Sulphate (SO4)	mg/L	58	5.0	110	5.0	A253422	68	5.0	A253354
Theoretical Gypsum Requirement	tonnes/ha	28	0.20	5.5	0.20	A250222	28	0.20	A250349

Elements									
Total Antimony (Sb)	mg/kg	<0.50	0.50	<0.50	0.50	A252785	<0.50	0.50	A252581
Total Arsenic (As)	mg/kg	9.2	1.0	13	1.0	A252785	6.4	1.0	A252581
Total Barium (Ba)	mg/kg	180	1.0	210	1.0	A252785	190	1.0	A252581
Total Beryllium (Be)	mg/kg	0.55	0.40	0.62	0.40	A252785	0.61	0.40	A252581

RDL = Reportable Detection Limit
 N/A = Not Applicable
 (1) Detection limits raised due to dilution to bring analyte within the calibrated range.



BV Labs Job #: C138809
 Report Date: 2021/06/18

ASSOCIATED ENGINEERING ALBERTA LTD.
 Client Project #: 2021-3981.001.140
 Site Location: TERWILLIGAR DR STAGE 2
 Your P.O. #: 2021-3981.001-140
 Sampler Initials: RH

AT1 METALS & SALINITY IN SOIL (SOIL)

BV Labs ID		ZY0064		ZY0065			ZY0066		
Sampling Date		2021/06/04		2021/06/04			2021/06/04		
COC Number		637640-04-01		637640-04-01			637640-04-01		
	UNITS	21HA16 (0.0-0.3M)	RDL	21HA16 (0.6-1.0M)	RDL	QC Batch	21HA17 (0.0-0.3M)	RDL	QC Batch
Total Cadmium (Cd)	mg/kg	0.26	0.050	0.28	0.050	A252785	0.33	0.050	A252581
Total Chromium (Cr)	mg/kg	31	1.0	20	1.0	A252785	29	1.0	A252581
Total Cobalt (Co)	mg/kg	9.6	0.50	10	0.50	A252785	8.3	0.50	A252581
Total Copper (Cu)	mg/kg	20	1.0	20	1.0	A252785	18	1.0	A252581
Total Lead (Pb)	mg/kg	19	0.50	9.8	0.50	A252785	11	0.50	A252581
Total Mercury (Hg)	mg/kg	<0.050	0.050	<0.050	0.050	A252785	<0.050	0.050	A252581
Total Molybdenum (Mo)	mg/kg	1.2	0.40	1.2	0.40	A252785	0.89	0.40	A252581
Total Nickel (Ni)	mg/kg	27	1.0	27	1.0	A252785	27	1.0	A252581
Total Selenium (Se)	mg/kg	<0.50	0.50	<0.50	0.50	A252785	0.53	0.50	A252581
Total Silver (Ag)	mg/kg	<0.20	0.20	<0.20	0.20	A252785	0.71	0.20	A252581
Total Thallium (Tl)	mg/kg	0.17	0.10	0.18	0.10	A252785	0.15	0.10	A252581
Total Tin (Sn)	mg/kg	<1.0	1.0	<1.0	1.0	A252785	<1.0	1.0	A252581
Total Uranium (U)	mg/kg	1.3	0.20	1.5	0.20	A252785	1.5	0.20	A252581
Total Vanadium (V)	mg/kg	28	1.0	24	1.0	A252785	30	1.0	A252581
Total Zinc (Zn)	mg/kg	77	10	68	10	A252785	65	10	A252581
RDL = Reportable Detection Limit									



BV Labs Job #: C138809
 Report Date: 2021/06/18

ASSOCIATED ENGINEERING ALBERTA LTD.
 Client Project #: 2021-3981.001.140
 Site Location: TERWILLIGAR DR STAGE 2
 Your P.O. #: 2021-3981.001-140
 Sampler Initials: RH

AT1 METALS & SALINITY IN SOIL (SOIL)

BV Labs ID		ZY0067			ZY0069		
Sampling Date		2021/06/04			2021/06/03		
COC Number		637640-04-01			637640-04-01		
	UNITS	21HA17 (0.6-1.0M)	RDL	QC Batch	21HA18 (0.6-1.0M)	RDL	QC Batch
Calculated Parameters							
Anion Sum	meq/L	40	N/A	A250356	130	N/A	A250356
Cation Sum	meq/L	40	N/A	A250356	120	N/A	A250356
Cation/EC Ratio	N/A	8.9	0.10	A250353	9.7	0.10	A250353
Calculated Calcium (Ca)	mg/kg	74	1.0	A250348	350	1.1	A250348
Calculated Magnesium (Mg)	mg/kg	16	0.68	A250348	120	0.71	A250348
Calculated Sodium (Na)	mg/kg	510	1.7	A250348	1400	1.8	A250348
Calculated Potassium (K)	mg/kg	9.0	0.88	A250348	13	0.92	A250348
Calculated Boron (B)	mg/kg	<0.068	0.068	A249392	<0.071	0.071	A249392
Calculated Chloride (Cl)	mg/kg	940	34	A250348	3100	140	A250348
Calculated Sulphate (SO4)	mg/kg	50	3.4	A250348	110	3.5	A250348
Elements							
Hex. Chromium (Cr 6+)	mg/kg	<0.080	0.080	A253026	<0.080	0.080	A253305
Soluble Parameters							
Soluble Boron (B)	mg/L	<0.10	0.10	A253354	<0.10	0.10	A253354
Soluble Chloride (Cl)	mg/L	1400 (1)	50	A253394	4400 (1)	200	A253394
Soluble Conductivity	dS/m	4.5	0.020	A253586	13	0.020	A253586
Soluble (CaCl2) pH	pH	7.84	N/A	A252076	7.79	N/A	A252076
Sodium Adsorption Ratio	N/A	17	0.10	A250357	19	0.10	A250357
Soluble Calcium (Ca)	mg/L	110	1.5	A253354	500	1.5	A253354
Soluble Magnesium (Mg)	mg/L	23	1.0	A253354	170	1.0	A253354
Soluble Sodium (Na)	mg/L	750	2.5	A253354	1900	2.5	A253354
Soluble Potassium (K)	mg/L	13	1.3	A253354	19	1.3	A253354
Saturation %	%	68	N/A	A252074	71	N/A	A252074
Soluble Sulphate (SO4)	mg/L	73	5.0	A253354	160	5.0	A253354
Theoretical Gypsum Requirement	tonnes/ha	14	0.20	A250349	100	0.20	A250349
Elements							
Total Antimony (Sb)	mg/kg	<0.50	0.50	A252581	<0.50	0.50	A252581
Total Arsenic (As)	mg/kg	7.6	1.0	A252581	9.5	1.0	A252581
Total Barium (Ba)	mg/kg	220	1.0	A252581	220	1.0	A252581
Total Beryllium (Be)	mg/kg	0.73	0.40	A252581	0.72	0.40	A252581
RDL = Reportable Detection Limit N/A = Not Applicable (1) Detection limits raised due to dilution to bring analyte within the calibrated range.							



BV Labs Job #: C138809
 Report Date: 2021/06/18

ASSOCIATED ENGINEERING ALBERTA LTD.
 Client Project #: 2021-3981.001.140
 Site Location: TERWILLIGAR DR STAGE 2
 Your P.O. #: 2021-3981.001-140
 Sampler Initials: RH

AT1 METALS & SALINITY IN SOIL (SOIL)

BV Labs ID		ZY0067			ZY0069		
Sampling Date		2021/06/04			2021/06/03		
COC Number		637640-04-01			637640-04-01		
	UNITS	21HA17 (0.6-1.0M)	RDL	QC Batch	21HA18 (0.6-1.0M)	RDL	QC Batch
Total Cadmium (Cd)	mg/kg	0.27	0.050	A252581	0.34	0.050	A252581
Total Chromium (Cr)	mg/kg	27	1.0	A252581	26	1.0	A252581
Total Cobalt (Co)	mg/kg	9.5	0.50	A252581	11	0.50	A252581
Total Copper (Cu)	mg/kg	21	1.0	A252581	29	1.0	A252581
Total Lead (Pb)	mg/kg	13	0.50	A252581	13	0.50	A252581
Total Mercury (Hg)	mg/kg	<0.050	0.050	A252581	<0.050	0.050	A252581
Total Molybdenum (Mo)	mg/kg	1.2	0.40	A252581	1.2	0.40	A252581
Total Nickel (Ni)	mg/kg	28	1.0	A252581	35	1.0	A252581
Total Selenium (Se)	mg/kg	<0.50	0.50	A252581	<0.50	0.50	A252581
Total Silver (Ag)	mg/kg	<0.20	0.20	A252581	<0.20	0.20	A252581
Total Thallium (Tl)	mg/kg	0.18	0.10	A252581	0.22	0.10	A252581
Total Tin (Sn)	mg/kg	<1.0	1.0	A252581	<1.0	1.0	A252581
Total Uranium (U)	mg/kg	1.5	0.20	A252581	1.2	0.20	A252581
Total Vanadium (V)	mg/kg	24	1.0	A252581	33	1.0	A252581
Total Zinc (Zn)	mg/kg	67	10	A252581	84	10	A252581
RDL = Reportable Detection Limit							



BV Labs Job #: C138809
 Report Date: 2021/06/18

ASSOCIATED ENGINEERING ALBERTA LTD.
 Client Project #: 2021-3981.001.140
 Site Location: TERWILLIGAR DR STAGE 2
 Your P.O. #: 2021-3981.001-140
 Sampler Initials: RH

AT1 METALS & SALINITY IN SOIL (SOIL)

BV Labs ID		ZY0070			ZY0071		
Sampling Date		2021/06/04			2021/06/04		
COC Number		637640-04-01			637640-04-01		
	UNITS	21HA19 (0.0-0.3M)	RDL	QC Batch	21HA19 (0.6-1.0M)	RDL	QC Batch
Calculated Parameters							
Anion Sum	meq/L	1200	N/A	A250356	72	N/A	A250356
Cation Sum	meq/L	1400	N/A	A250356	75	N/A	A250356
Cation/EC Ratio	N/A	14	0.10	A250353	10	0.10	A250353
Calculated Calcium (Ca)	mg/kg	2800	3.6	A250348	250	1.1	A250348
Calculated Magnesium (Mg)	mg/kg	1100	0.48	A250348	59	0.71	A250348
Calculated Sodium (Na)	mg/kg	10000	6.0	A250348	820	1.8	A250348
Calculated Potassium (K)	mg/kg	190	0.62	A250348	22	0.92	A250348
Calculated Boron (B)	mg/kg	0.15	0.048	A249392	<0.071	0.071	A249392
Calculated Chloride (Cl)	mg/kg	20000	960	A250348	1300	35	A250348
Calculated Sulphate (SO4)	mg/kg	1400	2.4	A250348	670	3.5	A250348
Elements							
Hex. Chromium (Cr 6+)	mg/kg	<0.080	0.080	A253026	<0.080	0.080	A252964
Soluble Parameters							
Soluble Boron (B)	mg/L	0.31	0.10	A253354	<0.10	0.10	A253422
Soluble Chloride (Cl)	mg/L	42000 (1)	2000	A253394	1900 (1)	50	A253396
Soluble Conductivity	dS/m	100	0.020	A253586	7.5	0.020	A253467
Soluble (CaCl2) pH	pH	7.32	N/A	A252076	7.85	N/A	A252072
Sodium Adsorption Ratio	N/A	60	0.10	A250357	14	0.10	A250357
Soluble Calcium (Ca)	mg/L	5900	7.5	A253354	350	1.5	A253422
Soluble Magnesium (Mg)	mg/L	2200	1.0	A253354	83	1.0	A253422
Soluble Sodium (Na)	mg/L	21000	13	A253354	1200	2.5	A253422
Soluble Potassium (K)	mg/L	390	1.3	A253354	31	1.3	A253422
Saturation %	%	48	N/A	A252074	71	N/A	A252069
Soluble Sulphate (SO4)	mg/L	2900	5.0	A253354	950	5.0	A253422
Theoretical Gypsum Requirement	tonnes/ha	8600	0.20	A250349	35	0.20	A250349
Elements							
Total Antimony (Sb)	mg/kg	<0.50	0.50	A252785	0.57	0.50	A252785
Total Arsenic (As)	mg/kg	5.4	1.0	A252785	8.5	1.0	A252785
Total Barium (Ba)	mg/kg	150	1.0	A252785	210	1.0	A252785
Total Beryllium (Be)	mg/kg	0.55	0.40	A252785	0.70	0.40	A252785
RDL = Reportable Detection Limit N/A = Not Applicable (1) Detection limits raised due to dilution to bring analyte within the calibrated range.							



BV Labs Job #: C138809
 Report Date: 2021/06/18

ASSOCIATED ENGINEERING ALBERTA LTD.
 Client Project #: 2021-3981.001.140
 Site Location: TERWILLIGAR DR STAGE 2
 Your P.O. #: 2021-3981.001-140
 Sampler Initials: RH

AT1 METALS & SALINITY IN SOIL (SOIL)

BV Labs ID		ZY0070			ZY0071		
Sampling Date		2021/06/04			2021/06/04		
COC Number		637640-04-01			637640-04-01		
	UNITS	21HA19 (0.0-0.3M)	RDL	QC Batch	21HA19 (0.6-1.0M)	RDL	QC Batch
Total Cadmium (Cd)	mg/kg	0.26	0.050	A252785	0.33	0.050	A252785
Total Chromium (Cr)	mg/kg	39	1.0	A252785	21	1.0	A252785
Total Cobalt (Co)	mg/kg	8.1	0.50	A252785	9.7	0.50	A252785
Total Copper (Cu)	mg/kg	29	1.0	A252785	25	1.0	A252785
Total Lead (Pb)	mg/kg	27	0.50	A252785	13	0.50	A252785
Total Mercury (Hg)	mg/kg	<0.050	0.050	A252785	<0.050	0.050	A252785
Total Molybdenum (Mo)	mg/kg	1.5	0.40	A252785	1.2	0.40	A252785
Total Nickel (Ni)	mg/kg	26	1.0	A252785	26	1.0	A252785
Total Selenium (Se)	mg/kg	0.80	0.50	A252785	<0.50	0.50	A252785
Total Silver (Ag)	mg/kg	<0.20	0.20	A252785	<0.20	0.20	A252785
Total Thallium (Tl)	mg/kg	0.13	0.10	A252785	0.25	0.10	A252785
Total Tin (Sn)	mg/kg	<1.0	1.0	A252785	<1.0	1.0	A252785
Total Uranium (U)	mg/kg	1.1	0.20	A252785	1.9	0.20	A252785
Total Vanadium (V)	mg/kg	34	1.0	A252785	25	1.0	A252785
Total Zinc (Zn)	mg/kg	100	10	A252785	67	10	A252785
RDL = Reportable Detection Limit							



BV Labs Job #: C138809
 Report Date: 2021/06/18

ASSOCIATED ENGINEERING ALBERTA LTD.
 Client Project #: 2021-3981.001.140
 Site Location: TERWILLIGAR DR STAGE 2
 Your P.O. #: 2021-3981.001-140
 Sampler Initials: RH

AT1 METALS & SALINITY IN SOIL (SOIL)

BV Labs ID		ZY0072			ZY0074		ZY0076		
Sampling Date		2021/06/03			2021/06/02		2021/06/02		
COC Number		637640-04-01			637640-05-01		637640-05-01		
	UNITS	21HA20 (0.0-0.3M)	RDL	QC Batch	21HA21 (0.0-0.3M)	RDL	21HA22 (0.0-0.3M)	RDL	QC Batch

Calculated Parameters									
Anion Sum	meq/L	140	N/A	A250356	47	N/A	44	N/A	A250356
Cation Sum	meq/L	150	N/A	A250356	50	N/A	51	N/A	A250356
Cation/EC Ratio	N/A	10	0.10	A250353	9.5	0.10	10	0.10	A250353
Calculated Calcium (Ca)	mg/kg	100	0.85	A250348	55	1.0	30	0.79	A250348
Calculated Magnesium (Mg)	mg/kg	16	0.57	A250348	9.6	0.67	4.1	0.53	A250348
Calculated Sodium (Na)	mg/kg	1800	1.4	A250348	690	1.7	580	1.3	A250348
Calculated Potassium (K)	mg/kg	9.5	0.74	A250348	7.7	0.87	5.5	0.69	A250348
Calculated Boron (B)	mg/kg	0.11	0.057	A249392	0.081	0.067	0.089	0.053	A249392
Calculated Chloride (Cl)	mg/kg	2700	110	A250348	1100	34	780	26	A250348
Calculated Sulphate (SO4)	mg/kg	98	2.8	A250348	84	3.4	69	2.6	A250348

Elements									
Hex. Chromium (Cr 6+)	mg/kg	<0.080	0.080	A253305	<0.080	0.080	<0.080	0.080	A252964

Soluble Parameters									
Soluble Boron (B)	mg/L	0.20	0.10	A253354	0.12	0.10	0.17	0.10	A253354
Soluble Chloride (Cl)	mg/L	4800 (1)	200	A253394	1600 (1)	50	1500 (1)	50	A253394
Soluble Conductivity	dS/m	15	0.020	A253586	5.3	0.020	5.1	0.020	A253586
Soluble (CaCl2) pH	pH	7.60	N/A	A252076	8.09	N/A	8.13	N/A	A252076
Sodium Adsorption Ratio	N/A	58	0.10	A250357	28	0.10	36	0.10	A250357
Soluble Calcium (Ca)	mg/L	180	1.5	A253354	81	1.5	56	1.5	A253354
Soluble Magnesium (Mg)	mg/L	28	1.0	A253354	14	1.0	7.8	1.0	A253354
Soluble Sodium (Na)	mg/L	3100	2.5	A253354	1000	2.5	1100	2.5	A253354
Soluble Potassium (K)	mg/L	17	1.3	A253354	12	1.3	10	1.3	A253354
Saturation %	%	57	N/A	A252074	67	N/A	53	N/A	A252074
Soluble Sulphate (SO4)	mg/L	170	5.0	A253354	130	5.0	130	5.0	A253354
Theoretical Gypsum Requirement	tonnes/ha	220	0.20	A250349	28	0.20	25	0.20	A250349

Elements									
Total Antimony (Sb)	mg/kg	0.83	0.50	A252581	<0.50	0.50	<0.50	0.50	A252581
Total Arsenic (As)	mg/kg	5.2	1.0	A252581	8.5	1.0	6.3	1.0	A252581
Total Barium (Ba)	mg/kg	160	1.0	A252581	200	1.0	160	1.0	A252581
Total Beryllium (Be)	mg/kg	0.56	0.40	A252581	0.74	0.40	0.55	0.40	A252581

RDL = Reportable Detection Limit
 N/A = Not Applicable
 (1) Detection limits raised due to dilution to bring analyte within the calibrated range.



BV Labs Job #: C138809
 Report Date: 2021/06/18

ASSOCIATED ENGINEERING ALBERTA LTD.
 Client Project #: 2021-3981.001.140
 Site Location: TERWILLIGAR DR STAGE 2
 Your P.O. #: 2021-3981.001-140
 Sampler Initials: RH

AT1 METALS & SALINITY IN SOIL (SOIL)

BV Labs ID		ZY0072			ZY0074		ZY0076		
Sampling Date		2021/06/03			2021/06/02		2021/06/02		
COC Number		637640-04-01			637640-05-01		637640-05-01		
	UNITS	21HA20 (0.0-0.3M)	RDL	QC Batch	21HA21 (0.0-0.3M)	RDL	21HA22 (0.0-0.3M)	RDL	QC Batch
Total Cadmium (Cd)	mg/kg	0.25	0.050	A252581	0.29	0.050	0.22	0.050	A252581
Total Chromium (Cr)	mg/kg	44	1.0	A252581	35	1.0	26	1.0	A252581
Total Cobalt (Co)	mg/kg	7.4	0.50	A252581	9.9	0.50	8.1	0.50	A252581
Total Copper (Cu)	mg/kg	21	1.0	A252581	23	1.0	17	1.0	A252581
Total Lead (Pb)	mg/kg	19	0.50	A252581	13	0.50	12	0.50	A252581
Total Mercury (Hg)	mg/kg	<0.050	0.050	A252581	<0.050	0.050	<0.050	0.050	A252581
Total Molybdenum (Mo)	mg/kg	1.6	0.40	A252581	1.2	0.40	0.99	0.40	A252581
Total Nickel (Ni)	mg/kg	29	1.0	A252581	32	1.0	25	1.0	A252581
Total Selenium (Se)	mg/kg	0.51	0.50	A252581	0.58	0.50	<0.50	0.50	A252581
Total Silver (Ag)	mg/kg	<0.20	0.20	A252581	<0.20	0.20	<0.20	0.20	A252581
Total Thallium (Tl)	mg/kg	0.13	0.10	A252581	0.20	0.10	0.14	0.10	A252581
Total Tin (Sn)	mg/kg	<1.0	1.0	A252581	<1.0	1.0	<1.0	1.0	A252581
Total Uranium (U)	mg/kg	1.8	0.20	A252581	2.0	0.20	1.7	0.20	A252581
Total Vanadium (V)	mg/kg	29	1.0	A252581	35	1.0	30	1.0	A252581
Total Zinc (Zn)	mg/kg	83	10	A252581	80	10	70	10	A252581
RDL = Reportable Detection Limit									



AT1 METALS & SALINITY IN SOIL (SOIL)

BV Labs ID		ZY0079			ZY0081		
Sampling Date		2021/06/02			2021/06/02		
COC Number		637640-05-01			637640-05-01		
	UNITS	21HA23 (0.6-1.0M)	RDL	QC Batch	21HA24 (0.6-1.0M)	RDL	QC Batch
Calculated Parameters							
Anion Sum	meq/L	110	N/A	A250356	110	N/A	A250356
Cation Sum	meq/L	110	N/A	A250356	110	N/A	A250356
Cation/EC Ratio	N/A	12	0.10	A250353	9.2	0.10	A250353
Calculated Calcium (Ca)	mg/kg	290	0.80	A250348	170	0.92	A250348
Calculated Magnesium (Mg)	mg/kg	27	0.54	A250348	33	0.61	A250348
Calculated Sodium (Na)	mg/kg	1000	1.3	A250348	1300	1.5	A250348
Calculated Potassium (K)	mg/kg	11	0.70	A250348	7.7	0.80	A250348
Calculated Boron (B)	mg/kg	<0.054	0.054	A249392	<0.061	0.061	A249392
Calculated Chloride (Cl)	mg/kg	750	27	A250348	2300	61	A250348
Calculated Sulphate (SO4)	mg/kg	1800	2.7	A250348	98	3.1	A250348
Elements							
Hex. Chromium (Cr 6+)	mg/kg	<0.080	0.080	A253305	<0.080	0.080	A252546
Soluble Parameters							
Soluble Boron (B)	mg/L	<0.10	0.10	A253354	<0.10	0.10	A253354
Soluble Chloride (Cl)	mg/L	1400 (1)	50	A253394	3700 (1)	100	A253394
Soluble Conductivity	dS/m	9.7	0.020	A253586	12	0.020	A253586
Soluble (CaCl2) pH	pH	7.67	N/A	A252076	7.98	N/A	A252076
Sodium Adsorption Ratio	N/A	21	0.10	A250357	30	0.10	A250357
Soluble Calcium (Ca)	mg/L	530	1.5	A253354	280	1.5	A253354
Soluble Magnesium (Mg)	mg/L	50	1.0	A253354	54	1.0	A253354
Soluble Sodium (Na)	mg/L	1900	2.5	A253354	2100	2.5	A253354
Soluble Potassium (K)	mg/L	20	1.3	A253354	13	1.3	A253354
Saturation %	%	54	N/A	A252074	61	N/A	A252074
Soluble Sulphate (SO4)	mg/L	3400	5.0	A253354	160	5.0	A253354
Theoretical Gypsum Requirement	tonnes/ha	74	0.20	A250349	100	0.20	A250349
Elements							
Total Antimony (Sb)	mg/kg	<0.50	0.50	A252785	<0.50	0.50	A252581
Total Arsenic (As)	mg/kg	7.9	1.0	A252785	8.3	1.0	A252581
Total Barium (Ba)	mg/kg	220	1.0	A252785	200	1.0	A252581
Total Beryllium (Be)	mg/kg	0.44	0.40	A252785	0.72	0.40	A252581
RDL = Reportable Detection Limit N/A = Not Applicable (1) Detection limits raised due to dilution to bring analyte within the calibrated range.							



BV Labs Job #: C138809
 Report Date: 2021/06/18

ASSOCIATED ENGINEERING ALBERTA LTD.
 Client Project #: 2021-3981.001.140
 Site Location: TERWILLIGAR DR STAGE 2
 Your P.O. #: 2021-3981.001-140
 Sampler Initials: RH

AT1 METALS & SALINITY IN SOIL (SOIL)

BV Labs ID		ZY0079			ZY0081		
Sampling Date		2021/06/02			2021/06/02		
COC Number		637640-05-01			637640-05-01		
	UNITS	21HA23 (0.6-1.0M)	RDL	QC Batch	21HA24 (0.6-1.0M)	RDL	QC Batch
Total Cadmium (Cd)	mg/kg	0.34	0.050	A252785	0.21	0.050	A252581
Total Chromium (Cr)	mg/kg	19	1.0	A252785	76	1.0	A252581
Total Cobalt (Co)	mg/kg	9.1	0.50	A252785	9.3	0.50	A252581
Total Copper (Cu)	mg/kg	19	1.0	A252785	22	1.0	A252581
Total Lead (Pb)	mg/kg	11	0.50	A252785	11	0.50	A252581
Total Mercury (Hg)	mg/kg	<0.050	0.050	A252785	0.061	0.050	A252581
Total Molybdenum (Mo)	mg/kg	1.1	0.40	A252785	2.2	0.40	A252581
Total Nickel (Ni)	mg/kg	25	1.0	A252785	50	1.0	A252581
Total Selenium (Se)	mg/kg	0.55	0.50	A252785	<0.50	0.50	A252581
Total Silver (Ag)	mg/kg	<0.20	0.20	A252785	<0.20	0.20	A252581
Total Thallium (Tl)	mg/kg	0.22	0.10	A252785	0.18	0.10	A252581
Total Tin (Sn)	mg/kg	<1.0	1.0	A252785	<1.0	1.0	A252581
Total Uranium (U)	mg/kg	1.2	0.20	A252785	0.96	0.20	A252581
Total Vanadium (V)	mg/kg	27	1.0	A252785	32	1.0	A252581
Total Zinc (Zn)	mg/kg	75	10	A252785	63	10	A252581
RDL = Reportable Detection Limit							



AT1 METALS & SALINITY IN SOIL (SOIL)

BV Labs ID		ZY0083			ZY0085		
Sampling Date		2021/06/02			2021/06/02		
COC Number		637640-05-01			637640-06-01		
	UNITS	21HA25 (0.6-1.0M)	RDL	QC Batch	21HA26 (0.6-1.0M)	RDL	QC Batch
Calculated Parameters							
Anion Sum	meq/L	110	N/A	A250356	140	N/A	A250356
Cation Sum	meq/L	110	N/A	A250356	140	N/A	A250356
Cation/EC Ratio	N/A	9.4	0.10	A250353	9.7	0.10	A250353
Calculated Calcium (Ca)	mg/kg	380	1.1	A250348	490	0.95	A250348
Calculated Magnesium (Mg)	mg/kg	150	0.74	A250348	140	0.63	A250348
Calculated Sodium (Na)	mg/kg	1200	1.9	A250348	1200	1.6	A250348
Calculated Potassium (K)	mg/kg	10	0.97	A250348	12	0.82	A250348
Calculated Boron (B)	mg/kg	<0.074	0.074	A249392	<0.063	0.063	A249392
Calculated Chloride (Cl)	mg/kg	3000	74	A250348	3100	130	A250348
Calculated Sulphate (SO4)	mg/kg	69	3.7	A250348	130	3.2	A250348
Elements							
Hex. Chromium (Cr 6+)	mg/kg	<0.080	0.080	A252546	<0.080	0.080	A252451
Soluble Parameters							
Soluble Boron (B)	mg/L	<0.10	0.10	A253423	<0.10	0.10	A253423
Soluble Chloride (Cl)	mg/L	4000 (1)	100	A253395	4900 (1)	200	A253395
Soluble Conductivity	dS/m	12	0.020	A253565	14	0.020	A253565
Soluble (CaCl2) pH	pH	7.66	N/A	A252145	7.52	N/A	A252145
Sodium Adsorption Ratio	N/A	15	0.10	A250357	16	0.10	A250357
Soluble Calcium (Ca)	mg/L	510	1.5	A253423	780	1.5	A253423
Soluble Magnesium (Mg)	mg/L	210	1.0	A253423	210	1.0	A253423
Soluble Sodium (Na)	mg/L	1600	2.5	A253423	1900	2.5	A253423
Soluble Potassium (K)	mg/L	14	1.3	A253423	19	1.3	A253423
Saturation %	%	74	N/A	A252137	63	N/A	A252137
Soluble Sulphate (SO4)	mg/L	92	5.0	A253423	210	5.0	A253423
Theoretical Gypsum Requirement	tonnes/ha	71	0.20	A250349	87	0.20	A250349
Elements							
Total Antimony (Sb)	mg/kg	<0.50	0.50	A252857	<0.50	0.50	A252857
Total Arsenic (As)	mg/kg	8.4	1.0	A252857	7.7	1.0	A252857
Total Barium (Ba)	mg/kg	220	1.0	A252857	200	1.0	A252857
Total Beryllium (Be)	mg/kg	0.67	0.40	A252857	0.68	0.40	A252857
RDL = Reportable Detection Limit N/A = Not Applicable (1) Detection limits raised due to dilution to bring analyte within the calibrated range.							



BV Labs Job #: C138809
 Report Date: 2021/06/18

ASSOCIATED ENGINEERING ALBERTA LTD.
 Client Project #: 2021-3981.001.140
 Site Location: TERWILLIGAR DR STAGE 2
 Your P.O. #: 2021-3981.001-140
 Sampler Initials: RH

AT1 METALS & SALINITY IN SOIL (SOIL)

BV Labs ID		ZY0083			ZY0085		
Sampling Date		2021/06/02			2021/06/02		
COC Number		637640-05-01			637640-06-01		
	UNITS	21HA25 (0.6-1.0M)	RDL	QC Batch	21HA26 (0.6-1.0M)	RDL	QC Batch
Total Cadmium (Cd)	mg/kg	0.31	0.050	A252857	0.25	0.050	A252857
Total Chromium (Cr)	mg/kg	23	1.0	A252857	22	1.0	A252857
Total Cobalt (Co)	mg/kg	10	0.50	A252857	10	0.50	A252857
Total Copper (Cu)	mg/kg	28	1.0	A252857	29	1.0	A252857
Total Lead (Pb)	mg/kg	13	0.50	A252857	12	0.50	A252857
Total Mercury (Hg)	mg/kg	<0.050	0.050	A252857	<0.050	0.050	A252857
Total Molybdenum (Mo)	mg/kg	1.1	0.40	A252857	0.99	0.40	A252857
Total Nickel (Ni)	mg/kg	28	1.0	A252857	27	1.0	A252857
Total Selenium (Se)	mg/kg	<0.50	0.50	A252857	0.81	0.50	A252857
Total Silver (Ag)	mg/kg	<0.20	0.20	A252857	<0.20	0.20	A252857
Total Thallium (Tl)	mg/kg	0.22	0.10	A252857	0.19	0.10	A252857
Total Tin (Sn)	mg/kg	<1.0	1.0	A252857	<1.0	1.0	A252857
Total Uranium (U)	mg/kg	1.1	0.20	A252857	1.3	0.20	A252857
Total Vanadium (V)	mg/kg	33	1.0	A252857	33	1.0	A252857
Total Zinc (Zn)	mg/kg	81	10	A252857	84	10	A252857
RDL = Reportable Detection Limit							



AT1 METALS & SALINITY IN SOIL (SOIL)

BV Labs ID		ZY0086			ZY0087		
Sampling Date		2021/06/02			2021/06/02		
COC Number		637640-06-01			637640-06-01		
	UNITS	21HA27 (0.0-0.3M)	RDL	QC Batch	21HA27 (0.6-1.0M)	RDL	QC Batch
Calculated Parameters							
Anion Sum	meq/L	37	N/A	A250356	65	N/A	A250356
Cation Sum	meq/L	41	N/A	A250356	67	N/A	A250356
Cation/EC Ratio	N/A	9.1	0.10	A250353	9.1	0.10	A250353
Calculated Calcium (Ca)	mg/kg	22	0.98	A250348	110	1.2	A250348
Calculated Magnesium (Mg)	mg/kg	2.2	0.65	A250348	18	0.78	A250348
Calculated Sodium (Na)	mg/kg	580	1.6	A250348	1000	1.9	A250348
Calculated Potassium (K)	mg/kg	7.6	0.85	A250348	6.1	1.0	A250348
Calculated Boron (B)	mg/kg	0.098	0.065	A249392	<0.078	0.078	A250346
Calculated Chloride (Cl)	mg/kg	820	33	A250348	1600	78	A250348
Calculated Sulphate (SO4)	mg/kg	46	3.3	A250348	190	3.9	A250348
Elements							
Hex. Chromium (Cr 6+)	mg/kg	<0.080	0.080	A252451	<0.080	0.080	A252546
Soluble Parameters							
Soluble Boron (B)	mg/L	0.15	0.10	A253354	<0.10	0.10	A253422
Soluble Chloride (Cl)	mg/L	1200 (1)	50	A253394	2100 (1)	100	A253396
Soluble Conductivity	dS/m	4.5	0.020	A253586	7.4	0.020	A253467
Soluble (CaCl2) pH	pH	8.24	N/A	A252076	7.97	N/A	A252072
Sodium Adsorption Ratio	N/A	39	0.10	A250357	28	0.10	A250357
Soluble Calcium (Ca)	mg/L	34	1.5	A253354	140	1.5	A253422
Soluble Magnesium (Mg)	mg/L	3.4	1.0	A253354	23	1.0	A253422
Soluble Sodium (Na)	mg/L	880	2.5	A253354	1300	2.5	A253422
Soluble Potassium (K)	mg/L	12	1.3	A253354	7.8	1.3	A253422
Saturation %	%	65	N/A	A252074	78	N/A	A252069
Soluble Sulphate (SO4)	mg/L	71	5.0	A253354	250	5.0	A253422
Theoretical Gypsum Requirement	tonnes/ha	20	0.20	A250349	54	0.20	A250349
Elements							
Total Antimony (Sb)	mg/kg	<0.50	0.50	A252581	<0.50	0.50	A252581
Total Arsenic (As)	mg/kg	5.8	1.0	A252581	8.8	1.0	A252581
Total Barium (Ba)	mg/kg	180	1.0	A252581	210	1.0	A252581
Total Beryllium (Be)	mg/kg	0.62	0.40	A252581	0.77	0.40	A252581
RDL = Reportable Detection Limit N/A = Not Applicable (1) Detection limits raised due to dilution to bring analyte within the calibrated range.							



BV Labs Job #: C138809
 Report Date: 2021/06/18

ASSOCIATED ENGINEERING ALBERTA LTD.
 Client Project #: 2021-3981.001.140
 Site Location: TERWILLIGAR DR STAGE 2
 Your P.O. #: 2021-3981.001-140
 Sampler Initials: RH

AT1 METALS & SALINITY IN SOIL (SOIL)

BV Labs ID		ZY0086			ZY0087		
Sampling Date		2021/06/02			2021/06/02		
COC Number		637640-06-01			637640-06-01		
	UNITS	21HA27 (0.0-0.3M)	RDL	QC Batch	21HA27 (0.6-1.0M)	RDL	QC Batch
Total Cadmium (Cd)	mg/kg	0.32	0.050	A252581	0.24	0.050	A252581
Total Chromium (Cr)	mg/kg	28	1.0	A252581	28	1.0	A252581
Total Cobalt (Co)	mg/kg	8.6	0.50	A252581	12	0.50	A252581
Total Copper (Cu)	mg/kg	22	1.0	A252581	27	1.0	A252581
Total Lead (Pb)	mg/kg	22	0.50	A252581	15	0.50	A252581
Total Mercury (Hg)	mg/kg	<0.050	0.050	A252581	<0.050	0.050	A252581
Total Molybdenum (Mo)	mg/kg	1.2	0.40	A252581	1.1	0.40	A252581
Total Nickel (Ni)	mg/kg	26	1.0	A252581	35	1.0	A252581
Total Selenium (Se)	mg/kg	<0.50	0.50	A252581	<0.50	0.50	A252581
Total Silver (Ag)	mg/kg	<0.20	0.20	A252581	<0.20	0.20	A252581
Total Thallium (Tl)	mg/kg	0.14	0.10	A252581	0.21	0.10	A252581
Total Tin (Sn)	mg/kg	<1.0	1.0	A252581	<1.0	1.0	A252581
Total Uranium (U)	mg/kg	0.61	0.20	A252581	1.1	0.20	A252581
Total Vanadium (V)	mg/kg	29	1.0	A252581	39	1.0	A252581
Total Zinc (Zn)	mg/kg	85	10	A252581	81	10	A252581
RDL = Reportable Detection Limit							



BV Labs Job #: C138809
 Report Date: 2021/06/18

ASSOCIATED ENGINEERING ALBERTA LTD.
 Client Project #: 2021-3981.001.140
 Site Location: TERWILLIGAR DR STAGE 2
 Your P.O. #: 2021-3981.001-140
 Sampler Initials: RH

AT1 METALS & SALINITY IN SOIL (SOIL)

BV Labs ID		ZY0089		ZY0091			ZY0092		
Sampling Date		2021/06/02		2021/06/02			2021/06/02		
COC Number		637640-06-01		637640-06-01			637640-06-01		
	UNITS	21HA28 (0.6-1.0M)	RDL	21HA29 (0.6-1.0M)	RDL	QC Batch	21HA30 (0.0-0.3M)	RDL	QC Batch
Calculated Parameters									
Anion Sum	meq/L	99	N/A	18	N/A	A250356	18	N/A	A250356
Cation Sum	meq/L	98	N/A	19	N/A	A250356	27	N/A	A250356
Cation/EC Ratio	N/A	9.3	0.10	9.0	0.10	A250353	11	0.10	A250353
Calculated Calcium (Ca)	mg/kg	99	0.67	31	0.99	A250348	21	0.90	A250348
Calculated Magnesium (Mg)	mg/kg	2.5	0.45	6.3	0.66	A250348	5.2	0.60	A250348
Calculated Sodium (Na)	mg/kg	890	1.1	250	1.7	A250348	330	1.5	A250348
Calculated Potassium (K)	mg/kg	7.2	0.58	3.1	0.86	A250348	10	0.78	A250348
Calculated Boron (B)	mg/kg	0.056	0.045	<0.066	0.066	A250346	0.12	0.060	A250346
Calculated Chloride (Cl)	mg/kg	1400	45	340	13	A250348	330	12	A250348
Calculated Sulphate (SO4)	mg/kg	260	2.2	100	3.3	A250348	57	3.0	A250348
Elements									
Hex. Chromium (Cr 6+)	mg/kg	<0.080	0.080	<0.080	0.080	A252546	<0.080	0.080	A253026
Soluble Parameters									
Soluble Boron (B)	mg/L	0.12	0.10	<0.10	0.10	A253423	0.20	0.10	A253354
Soluble Chloride (Cl)	mg/L	3100 (1)	100	510 (1)	20	A253395	550 (1)	20	A253394
Soluble Conductivity	dS/m	11	0.020	2.1	0.020	A253565	2.5	0.020	A253586
Soluble (CaCl2) pH	pH	9.39	N/A	7.78	N/A	A252145	7.89	N/A	A252076
Sodium Adsorption Ratio	N/A	36	0.10	13	0.10	A250357	22	0.10	A250357
Soluble Calcium (Ca)	mg/L	220	1.5	47	1.5	A253423	35	1.5	A253354
Soluble Magnesium (Mg)	mg/L	5.5	1.0	9.6	1.0	A253423	8.7	1.0	A253354
Soluble Sodium (Na)	mg/L	2000	2.5	370	2.5	A253423	560	2.5	A253354
Soluble Potassium (K)	mg/L	16	1.3	4.7	1.3	A253423	17	1.3	A253354
Saturation %	%	45	N/A	66	N/A	A252137	60	N/A	A252074
Soluble Sulphate (SO4)	mg/L	590	5.0	150	5.0	A253423	95	5.0	A253354
Theoretical Gypsum Requirement	tonnes/ha	69	0.20	3.3	0.20	A250349	7.1	0.20	A250349
Elements									
Total Antimony (Sb)	mg/kg	<0.50	0.50	<0.50	0.50	A252857	<0.50	0.50	A252581
Total Arsenic (As)	mg/kg	6.5	1.0	7.9	1.0	A252857	6.1	1.0	A252581
Total Barium (Ba)	mg/kg	180	1.0	200	1.0	A252857	150	1.0	A252581
Total Beryllium (Be)	mg/kg	<0.40	0.40	0.73	0.40	A252857	0.58	0.40	A252581
RDL = Reportable Detection Limit N/A = Not Applicable (1) Detection limits raised due to dilution to bring analyte within the calibrated range.									



BV Labs Job #: C138809
 Report Date: 2021/06/18

ASSOCIATED ENGINEERING ALBERTA LTD.
 Client Project #: 2021-3981.001.140
 Site Location: TERWILLIGAR DR STAGE 2
 Your P.O. #: 2021-3981.001-140
 Sampler Initials: RH

AT1 METALS & SALINITY IN SOIL (SOIL)

BV Labs ID		ZY0089		ZY0091			ZY0092		
Sampling Date		2021/06/02		2021/06/02			2021/06/02		
COC Number		637640-06-01		637640-06-01			637640-06-01		
	UNITS	21HA28 (0.6-1.0M)	RDL	21HA29 (0.6-1.0M)	RDL	QC Batch	21HA30 (0.0-0.3M)	RDL	QC Batch
Total Cadmium (Cd)	mg/kg	0.29	0.050	0.20	0.050	A252857	0.30	0.050	A252581
Total Chromium (Cr)	mg/kg	26	1.0	73	1.0	A252857	38	1.0	A252581
Total Cobalt (Co)	mg/kg	7.9	0.50	11	0.50	A252857	8.4	0.50	A252581
Total Copper (Cu)	mg/kg	13	1.0	25	1.0	A252857	22	1.0	A252581
Total Lead (Pb)	mg/kg	9.9	0.50	15	0.50	A252857	17	0.50	A252581
Total Mercury (Hg)	mg/kg	<0.050	0.050	<0.050	0.050	A252857	<0.050	0.050	A252581
Total Molybdenum (Mo)	mg/kg	1.2	0.40	2.1	0.40	A252857	1.2	0.40	A252581
Total Nickel (Ni)	mg/kg	25	1.0	52	1.0	A252857	30	1.0	A252581
Total Selenium (Se)	mg/kg	<0.50	0.50	<0.50	0.50	A252857	0.59	0.50	A252581
Total Silver (Ag)	mg/kg	<0.20	0.20	<0.20	0.20	A252857	<0.20	0.20	A252581
Total Thallium (Tl)	mg/kg	0.16	0.10	0.19	0.10	A252857	0.14	0.10	A252581
Total Tin (Sn)	mg/kg	<1.0	1.0	<1.0	1.0	A252857	<1.0	1.0	A252581
Total Uranium (U)	mg/kg	0.94	0.20	0.88	0.20	A252857	1.4	0.20	A252581
Total Vanadium (V)	mg/kg	22	1.0	35	1.0	A252857	31	1.0	A252581
Total Zinc (Zn)	mg/kg	53	10	72	10	A252857	82	10	A252581
RDL = Reportable Detection Limit									



AT1 METALS & SALINITY IN SOIL (SOIL)

BV Labs ID		ZY0094			ZY0095			ZY0096		
Sampling Date		2021/06/02			2021/06/02			2021/06/02		
COC Number		637640-07-01			637640-07-01			637640-07-01		
	UNITS	DUP 1	RDL	QC Batch	DUP 2	RDL	QC Batch	DUP 3	RDL	QC Batch

Calculated Parameters										
Anion Sum	meq/L	39	N/A	A250356	150	N/A	A250356	16	N/A	A250356
Cation Sum	meq/L	43	N/A	A250356	140	N/A	A250356	22	N/A	A250356
Cation/EC Ratio	N/A	9.3	0.10	A250353	9.4	0.10	A250353	9.8	0.10	A250353
Calculated Calcium (Ca)	mg/kg	39	0.94	A250348	620	1.2	A250348	8.7	0.53	A250348
Calculated Magnesium (Mg)	mg/kg	6.3	0.63	A250348	160	0.77	A250348	1.1	0.36	A250348
Calculated Sodium (Na)	mg/kg	550	1.6	A250348	1400	1.9	A250348	160	0.89	A250348
Calculated Potassium (K)	mg/kg	6.0	0.81	A250348	19	1.0	A250348	3.0	0.46	A250348
Calculated Boron (B)	mg/kg	0.089	0.063	A250346	<0.077	0.077	A250346	0.037	0.036	A250346
Calculated Chloride (Cl)	mg/kg	820	31	A250348	3900	150	A250348	180	7.1	A250348
Calculated Sulphate (SO4)	mg/kg	62	3.1	A250348	160	3.8	A250348	20	1.8	A250348

Elements										
Hex. Chromium (Cr 6+)	mg/kg	<0.080	0.080	A253305	<0.080	0.080	A253305	<0.080	0.080	A252964

Soluble Parameters										
Soluble Boron (B)	mg/L	0.14	0.10	A253423	<0.10	0.10	A253422	0.10	0.10	A253422
Soluble Chloride (Cl)	mg/L	1300 (1)	50	A253395	5100 (1)	200	A253396	510 (1)	20	A253396
Soluble Conductivity	dS/m	4.6	0.020	A253565	15	0.020	A253467	2.2	0.020	A253467
Soluble (CaCl2) pH	pH	8.01	N/A	A252145	7.53	N/A	A252072	7.62	N/A	A252072
Sodium Adsorption Ratio	N/A	27	0.10	A250357	15	0.10	A250357	23	0.10	A250357
Soluble Calcium (Ca)	mg/L	62	1.5	A253423	810	1.5	A253422	25	1.5	A253422
Soluble Magnesium (Mg)	mg/L	10	1.0	A253423	210	1.0	A253422	3.2	1.0	A253422
Soluble Sodium (Na)	mg/L	880	2.5	A253423	1900	2.5	A253422	460	2.5	A253422
Soluble Potassium (K)	mg/L	9.5	1.3	A253423	25	1.3	A253422	8.5	1.3	A253422
Saturation %	%	63	N/A	A252137	77	N/A	A252069	36	N/A	A252069
Soluble Sulphate (SO4)	mg/L	98	5.0	A253423	210	5.0	A253422	55	5.0	A253422
Theoretical Gypsum Requirement	tonnes/ha	19	0.20	A250349	100	0.20	A250349	2.9	0.20	A250349

Elements										
Total Antimony (Sb)	mg/kg	<0.50	0.50	A252857	<0.50	0.50	A252785	0.52	0.50	A252785
Total Arsenic (As)	mg/kg	6.4	1.0	A252857	9.9	1.0	A252785	4.0	1.0	A252785
Total Barium (Ba)	mg/kg	170	1.0	A252857	240	1.0	A252785	110	1.0	A252785
Total Beryllium (Be)	mg/kg	0.56	0.40	A252857	0.87	0.40	A252785	<0.40	0.40	A252785

RDL = Reportable Detection Limit

N/A = Not Applicable

(1) Detection limits raised due to dilution to bring analyte within the calibrated range.



BV Labs Job #: C138809
 Report Date: 2021/06/18

ASSOCIATED ENGINEERING ALBERTA LTD.
 Client Project #: 2021-3981.001.140
 Site Location: TERWILLIGAR DR STAGE 2
 Your P.O. #: 2021-3981.001-140
 Sampler Initials: RH

AT1 METALS & SALINITY IN SOIL (SOIL)

BV Labs ID		ZY0094			ZY0095			ZY0096		
Sampling Date		2021/06/02			2021/06/02			2021/06/02		
COC Number		637640-07-01			637640-07-01			637640-07-01		
	UNITS	DUP 1	RDL	QC Batch	DUP 2	RDL	QC Batch	DUP 3	RDL	QC Batch
Total Cadmium (Cd)	mg/kg	0.27	0.050	A252857	0.40	0.050	A252785	0.18	0.050	A252785
Total Chromium (Cr)	mg/kg	29	1.0	A252857	30	1.0	A252785	32	1.0	A252785
Total Cobalt (Co)	mg/kg	8.5	0.50	A252857	12	0.50	A252785	5.6	0.50	A252785
Total Copper (Cu)	mg/kg	22	1.0	A252857	29	1.0	A252785	17	1.0	A252785
Total Lead (Pb)	mg/kg	13	0.50	A252857	14	0.50	A252785	18	0.50	A252785
Total Mercury (Hg)	mg/kg	<0.050	0.050	A252857	<0.050	0.050	A252785	<0.050	0.050	A252785
Total Molybdenum (Mo)	mg/kg	1.1	0.40	A252857	1.1	0.40	A252785	1.3	0.40	A252785
Total Nickel (Ni)	mg/kg	27	1.0	A252857	34	1.0	A252785	21	1.0	A252785
Total Selenium (Se)	mg/kg	<0.50	0.50	A252857	0.92	0.50	A252785	<0.50	0.50	A252785
Total Silver (Ag)	mg/kg	<0.20	0.20	A252857	<0.20	0.20	A252785	<0.20	0.20	A252785
Total Thallium (Tl)	mg/kg	0.17	0.10	A252857	0.29	0.10	A252785	<0.10	0.10	A252785
Total Tin (Sn)	mg/kg	<1.0	1.0	A252857	<1.0	1.0	A252785	<1.0	1.0	A252785
Total Uranium (U)	mg/kg	1.9	0.20	A252857	1.4	0.20	A252785	0.51	0.20	A252785
Total Vanadium (V)	mg/kg	31	1.0	A252857	45	1.0	A252785	19	1.0	A252785
Total Zinc (Zn)	mg/kg	76	10	A252857	92	10	A252785	81	10	A252785
RDL = Reportable Detection Limit										



RESULTS OF CHEMICAL ANALYSES OF SOIL

BV Labs ID		ZY0022	ZY0025	ZY0055	ZY0057		
Sampling Date		2021/06/03	2021/06/02	2021/06/03	2021/06/03		
COC Number		637640-01-01	637640-01-01	637640-03-01	637640-03-01		
	UNITS	21HA02 (0.6-1.0M)	21HA04 (0.0-0.3M)	21HA11 (0.6-1.0M)	21HA12 (0.6-1.0M)	RDL	QC Batch
Physical Properties							
Grain Size	N/A	FINE	FINE	FINE	COARSE	N/A	A250214
Sieve - #10 (>2.00mm)	%	2.0	6.7	6.0	0.44	0.20	A252489
Sieve - #200 (>0.075mm)	%	28	17	7.1	56	0.20	A252489
Sieve - Pan	%	72	83	93	44	0.20	A252489
RDL = Reportable Detection Limit N/A = Not Applicable							

BV Labs ID		ZY0081	ZY0086		
Sampling Date		2021/06/02	2021/06/02		
COC Number		637640-05-01	637640-06-01		
	UNITS	21HA24 (0.6-1.0M)	21HA27 (0.0-0.3M)	RDL	QC Batch
Physical Properties					
Grain Size	N/A	FINE	FINE	N/A	A250214
Sieve - #10 (>2.00mm)	%	15	2.4	0.20	A252489
Sieve - #200 (>0.075mm)	%	30	25	0.20	A252489
Sieve - Pan	%	70	75	0.20	A252489
RDL = Reportable Detection Limit N/A = Not Applicable					



BV Labs Job #: C138809
Report Date: 2021/06/18

ASSOCIATED ENGINEERING ALBERTA LTD.
Client Project #: 2021-3981.001.140
Site Location: TERWILLIGAR DR STAGE 2
Your P.O. #: 2021-3981.001-140
Sampler Initials: RH

PETROLEUM HYDROCARBONS (CCME)

BV Labs ID		ZY0080		
Sampling Date		2021/06/02		
COC Number		637640-05-01		
	UNITS	21HA24 (0.0-0.3M)	RDL	QC Batch
Ext. Pet. Hydrocarbon				
F4G-SG (Heavy Hydrocarbons-Grav.)	mg/kg	4300	500	A254075
RDL = Reportable Detection Limit				



BV Labs Job #: C138809
Report Date: 2021/06/18

ASSOCIATED ENGINEERING ALBERTA LTD.
Client Project #: 2021-3981.001.140
Site Location: TERWILLIGAR DR STAGE 2
Your P.O. #: 2021-3981.001-140
Sampler Initials: RH

PHYSICAL TESTING (SOIL)

BV Labs ID		ZY0020	ZY0022		ZY0024	ZY0025		
Sampling Date		2021/06/02	2021/06/03		2021/06/03	2021/06/02		
COC Number		637640-01-01	637640-01-01		637640-01-01	637640-01-01		
	UNITS	21HA01 (0.6-1.0M)	21HA02 (0.6-1.0M)	QC Batch	21HA03 (0.6-1.0M)	21HA04 (0.0-0.3M)	RDL	QC Batch
Physical Properties								
Moisture	%	24	12	A251762	24	22	0.30	A251581
RDL = Reportable Detection Limit								

BV Labs ID		ZY0028		ZY0045	ZY0046		
Sampling Date		2021/06/03		2021/06/03	2021/06/03		
COC Number		637640-01-01		637640-02-01	637640-02-01		
	UNITS	21HA05 (0.6-1.0M)	QC Batch	21HA06 (0.6-1.0M)	21HA07 (0.0-0.3M)	RDL	QC Batch
Physical Properties							
Moisture	%	20	A251763	20	4.3	0.30	A251762
RDL = Reportable Detection Limit							

BV Labs ID		ZY0049	ZY0053	ZY0055	ZY0057		
Sampling Date		2021/06/03	2021/06/03	2021/06/03	2021/06/03		
COC Number		637640-02-01	637640-02-01	637640-03-01	637640-03-01		
	UNITS	21HA08 (0.6-1.0M)	21HA10 (0.6-1.0M)	21HA11 (0.6-1.0M)	21HA12 (0.6-1.0M)	RDL	QC Batch
Physical Properties							
Moisture	%	27	25	21	18	0.30	A251581
RDL = Reportable Detection Limit							

BV Labs ID		ZY0065	ZY0067	ZY0069	ZY0071		
Sampling Date		2021/06/04	2021/06/04	2021/06/03	2021/06/04		
COC Number		637640-04-01	637640-04-01	637640-04-01	637640-04-01		
	UNITS	21HA16 (0.6-1.0M)	21HA17 (0.6-1.0M)	21HA18 (0.6-1.0M)	21HA19 (0.6-1.0M)	RDL	QC Batch
Physical Properties							
Moisture	%	19	19	19	21	0.30	A251581
RDL = Reportable Detection Limit							

BV Labs ID		ZY0072	ZY0079		ZY0081	ZY0083		
Sampling Date		2021/06/03	2021/06/02		2021/06/02	2021/06/02		
COC Number		637640-04-01	637640-05-01		637640-05-01	637640-05-01		
	UNITS	21HA20 (0.0-0.3M)	21HA23 (0.6-1.0M)	QC Batch	21HA24 (0.6-1.0M)	21HA25 (0.6-1.0M)	RDL	QC Batch
Physical Properties								
Moisture	%	23	23	A251581	22	27	0.30	A251763
RDL = Reportable Detection Limit								



BV Labs Job #: C138809
 Report Date: 2021/06/18

ASSOCIATED ENGINEERING ALBERTA LTD.
 Client Project #: 2021-3981.001.140
 Site Location: TERWILLIGAR DR STAGE 2
 Your P.O. #: 2021-3981.001-140
 Sampler Initials: RH

PHYSICAL TESTING (SOIL)

BV Labs ID		ZY0086	ZY0089	ZY0091		ZY0092		
Sampling Date		2021/06/02	2021/06/02	2021/06/02		2021/06/02		
COC Number		637640-06-01	637640-06-01	637640-06-01		637640-06-01		
	UNITS	21HA27 (0.0-0.3M)	21HA28 (0.6-1.0M)	21HA29 (0.6-1.0M)	QC Batch	21HA30 (0.0-0.3M)	RDL	QC Batch

Physical Properties								
Moisture	%	12	21	31	A251763	23	0.30	A251581

RDL = Reportable Detection Limit



SEMIVOLATILE ORGANICS BY GC-MS (SOIL)

BV Labs ID		ZY0019	ZY0026	ZY0047	ZY0048		
Sampling Date		2021/06/02	2021/06/02	2021/06/03	2021/06/03		
COC Number		637640-01-01	637640-01-01	637640-02-01	637640-02-01		
	UNITS	21HA01 (0.0-0.3M)	21HA04 (0.6-1.0M)	21HA07 (0.6-1.0M)	21HA08 (0.0-0.3M)	RDL	QC Batch
Polycyclic Aromatics							
Acenaphthene	mg/kg	<0.0050	<0.0050	<0.0050	<0.0050	0.0050	A251733
B[a]P TPE Total Potency Equivalents	mg/kg	<0.0071	0.012	<0.0071	0.023	0.0071	A249299
Acenaphthylene	mg/kg	<0.0050	<0.0050	<0.0050	<0.0050	0.0050	A251733
Acridine	mg/kg	<0.010	<0.010	<0.010	<0.010	0.010	A251733
Anthracene	mg/kg	<0.0040	<0.0040	<0.0040	<0.0040	0.0040	A251733
Benzo(a)anthracene	mg/kg	<0.0050	<0.0050	<0.0050	0.014	0.0050	A251733
Benzo(b&j)fluoranthene	mg/kg	<0.0050	0.011	<0.0050	0.021	0.0050	A251733
Benzo(k)fluoranthene	mg/kg	<0.0050	<0.0050	<0.0050	0.0063	0.0050	A251733
Benzo(g,h,i)perylene	mg/kg	<0.0050	<0.0050	<0.0050	0.011	0.0050	A251733
Benzo(c)phenanthrene	mg/kg	<0.0050	<0.0050	<0.0050	<0.0050	0.0050	A251733
Benzo(a)pyrene	mg/kg	<0.0050	0.0073	<0.0050	0.015	0.0050	A251733
Benzo(e)pyrene	mg/kg	<0.0050	<0.0050	<0.0050	0.010	0.0050	A251733
Chrysene	mg/kg	<0.0050	<0.0050	<0.0050	0.012	0.0050	A251733
Dibenz(a,h)anthracene	mg/kg	<0.0050	<0.0050	<0.0050	<0.0050	0.0050	A251733
Fluoranthene	mg/kg	<0.0050	<0.0050	<0.0050	0.037	0.0050	A251733
Fluorene	mg/kg	<0.0050	<0.0050	<0.0050	<0.0050	0.0050	A251733
Indeno(1,2,3-cd)pyrene	mg/kg	<0.0050	<0.0050	<0.0050	0.0094	0.0050	A251733
1-Methylnaphthalene	mg/kg	<0.0050	<0.0050	<0.0050	<0.0050	0.0050	A251733
2-Methylnaphthalene	mg/kg	<0.0050	<0.0050	<0.0050	<0.0050	0.0050	A251733
Naphthalene	mg/kg	<0.0050	<0.0050	<0.0050	<0.0050	0.0050	A251733
Phenanthrene	mg/kg	<0.0050	<0.0050	<0.0050	0.019	0.0050	A251733
Perylene	mg/kg	<0.0050	0.088	<0.0050	<0.0050	0.0050	A251733
Pyrene	mg/kg	<0.0050	0.021	<0.0050	0.033	0.0050	A251733
Quinoline	mg/kg	<0.010	<0.010	<0.010	<0.010	0.010	A251733
Surrogate Recovery (%)							
D10-ANTHRACENE (sur.)	%	104	118	111	111		A251733
D8-ACENAPHTHYLENE (sur.)	%	99	110	106	107		A251733
D8-NAPHTHALENE (sur.)	%	89	97	93	94		A251733
TERPHENYL-D14 (sur.)	%	93	99	97	94		A251733
RDL = Reportable Detection Limit							



BV Labs Job #: C138809
Report Date: 2021/06/18

ASSOCIATED ENGINEERING ALBERTA LTD.
Client Project #: 2021-3981.001.140
Site Location: TERWILLIGAR DR STAGE 2
Your P.O. #: 2021-3981.001-140
Sampler Initials: RH

SEMIVOLATILE ORGANICS BY GC-MS (SOIL)

BV Labs ID		ZY0050	ZY0054	ZY0068	ZY0076		
Sampling Date		2021/06/03	2021/06/03	2021/06/03	2021/06/02		
COC Number		637640-02-01	637640-03-01	637640-04-01	637640-05-01		
	UNITS	21HA09 (0.0-0.3M)	21HA11 (0.0-0.3M)	21HA18 (0.0-0.3M)	21HA22 (0.0-0.3M)	RDL	QC Batch
Polycyclic Aromatics							
Acenaphthene	mg/kg	<0.0050	<0.0050	<0.0050	<0.0050	0.0050	A251733
B[a]P TPE Total Potency Equivalents	mg/kg	<0.0071	<0.0071	<0.0071	<0.0071	0.0071	A249299
Acenaphthylene	mg/kg	<0.0050	<0.0050	<0.0050	<0.0050	0.0050	A251733
Acridine	mg/kg	<0.010	<0.010	<0.010	<0.010	0.010	A251733
Anthracene	mg/kg	<0.0040	<0.0040	<0.0040	<0.0040	0.0040	A251733
Benzo(a)anthracene	mg/kg	<0.0050	<0.0050	<0.0050	<0.0050	0.0050	A251733
Benzo(b&j)fluoranthene	mg/kg	0.0065	0.012	<0.0050	<0.0050	0.0050	A251733
Benzo(k)fluoranthene	mg/kg	<0.0050	<0.0050	<0.0050	<0.0050	0.0050	A251733
Benzo(g,h,i)perylene	mg/kg	0.0080	0.0063	<0.0050	<0.0050	0.0050	A251733
Benzo(c)phenanthrene	mg/kg	<0.0050	<0.0050	<0.0050	<0.0050	0.0050	A251733
Benzo(a)pyrene	mg/kg	<0.0050	<0.0050	<0.0050	<0.0050	0.0050	A251733
Benzo(e)pyrene	mg/kg	<0.0050	0.0070	<0.0050	<0.0050	0.0050	A251733
Chrysene	mg/kg	<0.0050	<0.0050	<0.0050	<0.0050	0.0050	A251733
Dibenz(a,h)anthracene	mg/kg	<0.0050	<0.0050	<0.0050	<0.0050	0.0050	A251733
Fluoranthene	mg/kg	<0.0050	<0.0050	0.0079	<0.0050	0.0050	A251733
Fluorene	mg/kg	<0.0050	<0.0050	<0.0050	<0.0050	0.0050	A251733
Indeno(1,2,3-cd)pyrene	mg/kg	<0.0050	<0.0050	<0.0050	<0.0050	0.0050	A251733
1-Methylnaphthalene	mg/kg	<0.0050	<0.0050	<0.0050	<0.0050	0.0050	A251733
2-Methylnaphthalene	mg/kg	<0.0050	<0.0050	<0.0050	<0.0050	0.0050	A251733
Naphthalene	mg/kg	<0.0050	<0.0050	<0.0050	<0.0050	0.0050	A251733
Phenanthrene	mg/kg	<0.0050	<0.0050	0.0088	<0.0050	0.0050	A251733
Perylene	mg/kg	<0.0050	0.041	<0.0050	<0.0050	0.0050	A251733
Pyrene	mg/kg	0.0062	0.020	0.0072	<0.0050	0.0050	A251733
Quinoline	mg/kg	<0.010	<0.010	<0.010	<0.010	0.010	A251733
Surrogate Recovery (%)							
D10-ANTHRACENE (sur.)	%	122	112	98	54		A251733
D8-ACENAPHTHYLENE (sur.)	%	119	107	101	57		A251733
D8-NAPHTHALENE (sur.)	%	104	93	91	52		A251733
TERPHENYL-D14 (sur.)	%	103	96	101	58		A251733
RDL = Reportable Detection Limit							



BV Labs Job #: C138809
 Report Date: 2021/06/18

ASSOCIATED ENGINEERING ALBERTA LTD.
 Client Project #: 2021-3981.001.140
 Site Location: TERWILLIGAR DR STAGE 2
 Your P.O. #: 2021-3981.001-140
 Sampler Initials: RH

SEMIVOLATILE ORGANICS BY GC-MS (SOIL)

BV Labs ID		ZY0082	ZY0090	ZY0096		
Sampling Date		2021/06/02	2021/06/02	2021/06/02		
COC Number		637640-05-01	637640-06-01	637640-07-01		
	UNITS	21HA25 (0.0-0.3M)	21HA29 (0.0-0.3M)	DUP 3	RDL	QC Batch
Polycyclic Aromatics						
Acenaphthene	mg/kg	<0.0050	<0.0050	<0.0050	0.0050	A251733
B[a]P TPE Total Potency Equivalents	mg/kg	<0.0071	<0.0071	<0.0071	0.0071	A249299
Acenaphthylene	mg/kg	<0.0050	<0.0050	<0.0050	0.0050	A251733
Acridine	mg/kg	<0.010	<0.010	<0.010	0.010	A251733
Anthracene	mg/kg	<0.0040	<0.0040	<0.0040	0.0040	A251733
Benzo(a)anthracene	mg/kg	<0.0050	<0.0050	<0.0050	0.0050	A251733
Benzo(b&j)fluoranthene	mg/kg	<0.0050	<0.0050	<0.0050	0.0050	A251733
Benzo(k)fluoranthene	mg/kg	<0.0050	<0.0050	<0.0050	0.0050	A251733
Benzo(g,h,i)perylene	mg/kg	<0.0050	<0.0050	<0.0050	0.0050	A251733
Benzo(c)phenanthrene	mg/kg	<0.0050	<0.0050	<0.0050	0.0050	A251733
Benzo(a)pyrene	mg/kg	<0.0050	<0.0050	<0.0050	0.0050	A251733
Benzo(e)pyrene	mg/kg	<0.0050	<0.0050	<0.0050	0.0050	A251733
Chrysene	mg/kg	<0.0050	<0.0050	<0.0050	0.0050	A251733
Dibenz(a,h)anthracene	mg/kg	<0.0050	<0.0050	<0.0050	0.0050	A251733
Fluoranthene	mg/kg	<0.0050	<0.0050	<0.0050	0.0050	A251733
Fluorene	mg/kg	<0.0050	<0.0050	<0.0050	0.0050	A251733
Indeno(1,2,3-cd)pyrene	mg/kg	<0.0050	<0.0050	<0.0050	0.0050	A251733
1-Methylnaphthalene	mg/kg	<0.0050	<0.0050	<0.0050	0.0050	A251733
2-Methylnaphthalene	mg/kg	<0.0050	<0.0050	<0.0050	0.0050	A251733
Naphthalene	mg/kg	<0.0050	<0.0050	<0.0050	0.0050	A251733
Phenanthrene	mg/kg	<0.0050	<0.0050	<0.0050	0.0050	A251733
Perylene	mg/kg	<0.0050	<0.0050	<0.0050	0.0050	A251733
Pyrene	mg/kg	<0.0050	<0.0050	<0.0050	0.0050	A251733
Quinoline	mg/kg	<0.010	<0.010	<0.010	0.010	A251733
Surrogate Recovery (%)						
D10-ANTHRACENE (sur.)	%	96	107	90		A251733
D8-ACENAPHTHYLENE (sur.)	%	97	101	92		A251733
D8-NAPHTHALENE (sur.)	%	89	91	85		A251733
TERPHENYL-D14 (sur.)	%	107	97	103		A251733
RDL = Reportable Detection Limit						



PFAS STANDARD LIST 22 - SOIL (SOIL)

BV Labs ID		ZY0059	ZY0061		ZY0063		
Sampling Date		2021/06/04 10:00	2021/06/04 11:00		2021/06/04 12:00		
COC Number		637640-03-01	637640-03-01		637640-03-01		
	UNITS	21HA13 (1.0-1.3M)	21HA14 (1.0-1.3M)	QC Batch	21HA15 (1.0-1.3M)	RDL	QC Batch
MISCELLANEOUS							
Perfluorobutanoic acid	ug/kg	<1.0	<1.0	A259017	<1.0	1.0	A259017
Perfluoropentanoic Acid (PFPeA)	ug/kg	<1.0	<1.0	A259017	<1.0	1.0	A259017
Perfluorohexanoic Acid (PFHxA)	ug/kg	<1.0	<1.0	A259017	<1.0	1.0	A259017
Perfluoroheptanoic Acid (PFHpA)	ug/kg	<1.0	<1.0	A259017	<1.0	1.0	A259017
Perfluorooctanoic Acid (PFOA)	ug/kg	<1.0	<1.0	A259017	1.1	1.0	A259017
Perfluorononanoic Acid (PFNA)	ug/kg	<1.0	<1.0	A259017	<1.0	1.0	A259017
Perfluorodecanoic Acid (PFDA)	ug/kg	<1.0	<1.0	A259017	<1.0	1.0	A259017
Perfluoroundecanoic Acid (PFUnA)	ug/kg	<1.0	<1.0	A259017	<1.0	1.0	A259017
Perfluorododecanoic Acid (PFDoA)	ug/kg	<1.0	<1.0	A259017	<1.0	1.0	A259017
Perfluorotridecanoic Acid	ug/kg	<1.0	<1.0	A259017	<1.0	1.0	A259017
Perfluorotetradecanoic Acid	ug/kg	<1.0	<1.0	A259017	<1.0	1.0	A259017
Perfluorobutanesulfonic acid	ug/kg	<1.0	<1.0	A259017	<1.0	1.0	A259017
Perfluoropentanesulfonic acid	ug/kg	<1.0	<1.0	A259017	<1.0	1.0	A259017
Perfluorohexanesulfonic acid	ug/kg	<1.0	<1.0	A259017	<1.0	1.0	A259017
Perfluoroheptanesulfonic acid	ug/kg	<1.0	<1.0	A259017	<1.0	1.0	A259017
Perfluorooctanesulfonic acid	ug/kg	<1.0	<1.0	A259017	<1.0	1.0	A259017
Perfluorononane sulfonic acid	ug/kg	<1.0	<1.0	A259017	<1.0	1.0	A259017
Perfluorodecanesulfonic acid (PFDS)	ug/kg	<1.0	<1.0	A259017	<1.0	1.0	A259017
Perfluorooctane Sulfonamide (PFOSA)	ug/kg	<1.0	<1.0	A259017	<1.0	1.0	A259017
Physical Properties							
Moisture	%	20	24	A259016	17	1.0	A259018
Surrogate Recovery (%)							
13C2-Perfluorodecanoic acid	%	80	80	A259017	69		A259017
13C2-Perfluorododecanoic acid	%	81	79	A259017	66		A259017
13C2-Perfluorohexanoic acid	%	89	89	A259017	79		A259017
13C2-perfluorotetradecanoic acid	%	77	76	A259017	61		A259017
13C2-Perfluoroundecanoic acid	%	81	79	A259017	69		A259017
13C3-Perfluorobutanesulfonic acid	%	93	93	A259017	82		A259017
13C4-Perfluorobutanoic acid	%	88	89	A259017	80		A259017
13C4-Perfluoroheptanoic acid	%	86	88	A259017	77		A259017
13C4-Perfluorooctanesulfonic acid	%	91	89	A259017	75		A259017
RDL = Reportable Detection Limit							



BV Labs Job #: C138809
 Report Date: 2021/06/18

ASSOCIATED ENGINEERING ALBERTA LTD.
 Client Project #: 2021-3981.001.140
 Site Location: TERWILLIGAR DR STAGE 2
 Your P.O. #: 2021-3981.001-140
 Sampler Initials: RH

PFAS STANDARD LIST 22 - SOIL (SOIL)

BV Labs ID		ZY0059	ZY0061		ZY0063		
Sampling Date		2021/06/04 10:00	2021/06/04 11:00		2021/06/04 12:00		
COC Number		637640-03-01	637640-03-01		637640-03-01		
	UNITS	21HA13 (1.0-1.3M)	21HA14 (1.0-1.3M)	QC Batch	21HA15 (1.0-1.3M)	RDL	QC Batch
13C4-Perfluorooctanoic acid	%	85	83	A259017	75		A259017
13C5-Perfluorononanoic acid	%	84	84	A259017	74		A259017
13C5-Perfluoropentanoic acid	%	89	89	A259017	80		A259017
13C8-Perfluorooctane Sulfonamide	%	69	68	A259017	60		A259017
18O2-Perfluorohexanesulfonic acid	%	89	89	A259017	77		A259017
RDL = Reportable Detection Limit							



BV Labs Job #: C138809
Report Date: 2021/06/18

ASSOCIATED ENGINEERING ALBERTA LTD.
Client Project #: 2021-3981.001.140
Site Location: TERWILLIGAR DR STAGE 2
Your P.O. #: 2021-3981.001-140
Sampler Initials: RH

GENERAL COMMENTS

Each temperature is the average of up to three cooler temperatures taken at receipt

Package 1	6.3°C
Package 2	17.7°C
Package 3	18.7°C
Package 4	9.3°C

Results relate only to the items tested.



QUALITY ASSURANCE REPORT

QA/QC Batch	Init	QC Type	Parameter	Date Analyzed	Value	Recovery	UNITS	QC Limits
A250930	DO1	Matrix Spike [ZY0019-03]	1,4-Difluorobenzene (sur.)	2021/06/10		93	%	50 - 140
			4-Bromofluorobenzene (sur.)	2021/06/10		103	%	50 - 140
			D10-o-Xylene (sur.)	2021/06/10		134	%	50 - 140
			D4-1,2-Dichloroethane (sur.)	2021/06/10		105	%	50 - 140
			Benzene	2021/06/10		106	%	50 - 140
			Toluene	2021/06/10		107	%	50 - 140
			Ethylbenzene	2021/06/10		103	%	50 - 140
			m & p-Xylene	2021/06/10		104	%	50 - 140
			o-Xylene	2021/06/10		104	%	50 - 140
			F1 (C6-C10)	2021/06/10		108	%	60 - 140
			A250930	DO1	Spiked Blank	1,4-Difluorobenzene (sur.)	2021/06/10	
4-Bromofluorobenzene (sur.)	2021/06/10					106	%	50 - 140
D10-o-Xylene (sur.)	2021/06/10					120	%	50 - 140
D4-1,2-Dichloroethane (sur.)	2021/06/10					106	%	50 - 140
Benzene	2021/06/10					110	%	60 - 130
Toluene	2021/06/10					112	%	60 - 130
Ethylbenzene	2021/06/10					105	%	60 - 130
m & p-Xylene	2021/06/10					109	%	60 - 130
o-Xylene	2021/06/10					108	%	60 - 130
F1 (C6-C10)	2021/06/10					110	%	60 - 140
A250930	DO1	Method Blank				1,4-Difluorobenzene (sur.)	2021/06/10	
			4-Bromofluorobenzene (sur.)	2021/06/10		103	%	50 - 140
			D10-o-Xylene (sur.)	2021/06/10		114	%	50 - 140
			D4-1,2-Dichloroethane (sur.)	2021/06/10		103	%	50 - 140
			Benzene	2021/06/10	<0.0050		mg/kg	
			Toluene	2021/06/10	<0.050		mg/kg	
			Ethylbenzene	2021/06/10	<0.021 (1)		mg/kg	
			m & p-Xylene	2021/06/10	<0.050 (1)		mg/kg	
			o-Xylene	2021/06/10	<0.040 (1)		mg/kg	
			F1 (C6-C10)	2021/06/10	<10		mg/kg	
			A250930	DO1	RPD [ZY0019-03]	Benzene	2021/06/10	NC
Toluene	2021/06/10	NC					%	50
Ethylbenzene	2021/06/10	NC					%	50
m & p-Xylene	2021/06/10	NC					%	50
o-Xylene	2021/06/10	NC					%	50
F1 (C6-C10)	2021/06/10	NC					%	30
A250944	DO1	Matrix Spike [ZY0080-03]	1,4-Difluorobenzene (sur.)	2021/06/10		84	%	50 - 140
			4-Bromofluorobenzene (sur.)	2021/06/10		105	%	50 - 140
			D10-o-Xylene (sur.)	2021/06/10		114	%	50 - 140
			D4-1,2-Dichloroethane (sur.)	2021/06/10		136	%	50 - 140
			Benzene	2021/06/10		104	%	50 - 140
			Toluene	2021/06/10		96	%	50 - 140
			Ethylbenzene	2021/06/10		92	%	50 - 140
			m & p-Xylene	2021/06/10		95	%	50 - 140
			o-Xylene	2021/06/10		102	%	50 - 140
			F1 (C6-C10)	2021/06/10		98	%	60 - 140
			A250944	DO1	Spiked Blank	1,4-Difluorobenzene (sur.)	2021/06/10	
4-Bromofluorobenzene (sur.)	2021/06/10					101	%	50 - 140
D10-o-Xylene (sur.)	2021/06/10					117	%	50 - 140
D4-1,2-Dichloroethane (sur.)	2021/06/10					109	%	50 - 140
Benzene	2021/06/10					108	%	60 - 130
Toluene	2021/06/10					113	%	60 - 130



QUALITY ASSURANCE REPORT(CONT'D)

QA/QC Batch	Init	QC Type	Parameter	Date Analyzed	Value	Recovery	UNITS	QC Limits
A250944	DO1	Method Blank	Ethylbenzene	2021/06/10		116	%	60 - 130
			m & p-Xylene	2021/06/10		113	%	60 - 130
			o-Xylene	2021/06/10		110	%	60 - 130
			F1 (C6-C10)	2021/06/10		90	%	60 - 140
			1,4-Difluorobenzene (sur.)	2021/06/10		96	%	50 - 140
			4-Bromofluorobenzene (sur.)	2021/06/10		101	%	50 - 140
			D10-o-Xylene (sur.)	2021/06/10		113	%	50 - 140
			D4-1,2-Dichloroethane (sur.)	2021/06/10		106	%	50 - 140
			Benzene	2021/06/10	<0.0050		mg/kg	
			Toluene	2021/06/10	<0.050		mg/kg	
A250944	DO1	RPD [ZY0080-03]	Ethylbenzene	2021/06/10	<0.010		mg/kg	
			m & p-Xylene	2021/06/10	<0.040		mg/kg	
			o-Xylene	2021/06/10	<0.020		mg/kg	
			F1 (C6-C10)	2021/06/10	<10		mg/kg	
			Benzene	2021/06/10	NC		%	50
			Toluene	2021/06/10	NC		%	50
			Ethylbenzene	2021/06/10	NC		%	50
			m & p-Xylene	2021/06/10	NC		%	50
			o-Xylene	2021/06/10	NC		%	50
			F1 (C6-C10)	2021/06/10	NC		%	30
A251226	HAZ	Matrix Spike	O-TERPHENYL (sur.)	2021/06/10		87	%	60 - 140
			F2 (C10-C16 Hydrocarbons)	2021/06/10		80	%	60 - 140
			F3 (C16-C34 Hydrocarbons)	2021/06/10		93	%	60 - 140
			F4 (C34-C50 Hydrocarbons)	2021/06/10		87	%	60 - 140
A251226	HAZ	Spiked Blank	O-TERPHENYL (sur.)	2021/06/10		100	%	60 - 140
			F2 (C10-C16 Hydrocarbons)	2021/06/10		98	%	60 - 140
			F3 (C16-C34 Hydrocarbons)	2021/06/10		105	%	60 - 140
			F4 (C34-C50 Hydrocarbons)	2021/06/10		97	%	60 - 140
A251226	HAZ	Method Blank	O-TERPHENYL (sur.)	2021/06/10		111	%	60 - 140
			F2 (C10-C16 Hydrocarbons)	2021/06/10	<10		mg/kg	
			F3 (C16-C34 Hydrocarbons)	2021/06/10	<50		mg/kg	
			F4 (C34-C50 Hydrocarbons)	2021/06/10	<50		mg/kg	
A251226	HAZ	RPD	F2 (C10-C16 Hydrocarbons)	2021/06/10	NC		%	40
			F3 (C16-C34 Hydrocarbons)	2021/06/10	1.7		%	40
			F4 (C34-C50 Hydrocarbons)	2021/06/10	NC		%	40
A251581	ARV	Method Blank	Moisture	2021/06/11	<0.30		%	
A251581	ARV	RPD [ZY0049-01]	Moisture	2021/06/11	2.2		%	20
A251730	LLO	Matrix Spike [ZY0019-02]	O-TERPHENYL (sur.)	2021/06/12		129	%	60 - 140
			F2 (C10-C16 Hydrocarbons)	2021/06/12		129	%	60 - 140
			F3 (C16-C34 Hydrocarbons)	2021/06/12		126	%	60 - 140
			F4 (C34-C50 Hydrocarbons)	2021/06/12		123	%	60 - 140
A251730	LLO	Spiked Blank	O-TERPHENYL (sur.)	2021/06/11		92	%	60 - 140
			F2 (C10-C16 Hydrocarbons)	2021/06/11		91	%	60 - 140
			F3 (C16-C34 Hydrocarbons)	2021/06/11		95	%	60 - 140
			F4 (C34-C50 Hydrocarbons)	2021/06/11		92	%	60 - 140
A251730	LLO	Method Blank	O-TERPHENYL (sur.)	2021/06/11		100	%	60 - 140
			F2 (C10-C16 Hydrocarbons)	2021/06/11	<10		mg/kg	
			F3 (C16-C34 Hydrocarbons)	2021/06/11	<50		mg/kg	
			F4 (C34-C50 Hydrocarbons)	2021/06/11	<50		mg/kg	
A251730	LLO	RPD [ZY0019-02]	F2 (C10-C16 Hydrocarbons)	2021/06/12	NC		%	40
			F3 (C16-C34 Hydrocarbons)	2021/06/12	NC		%	40
			F4 (C34-C50 Hydrocarbons)	2021/06/12	NC		%	40



BV Labs Job #: C138809
 Report Date: 2021/06/18

ASSOCIATED ENGINEERING ALBERTA LTD.
 Client Project #: 2021-3981.001.140
 Site Location: TERWILLIGAR DR STAGE 2
 Your P.O. #: 2021-3981.001-140
 Sampler Initials: RH

QUALITY ASSURANCE REPORT(CONT'D)

QA/QC	Batch	Init	QC Type	Parameter	Date Analyzed	Value	Recovery	UNITS	QC Limits	
A251733	JU2	Matrix Spike [ZY0019-02]	D10-ANTHRACENE (sur.)	2021/06/12	103	%	50 - 130			
			D8-ACENAPHTHYLENE (sur.)	2021/06/12	99	%	50 - 130			
			D8-NAPHTHALENE (sur.)	2021/06/12	88	%	50 - 130			
			TERPHENYL-D14 (sur.)	2021/06/12	89	%	50 - 130			
			Acenaphthene	2021/06/12	93	%	50 - 130			
			Acenaphthylene	2021/06/12	103	%	50 - 130			
			Acridine	2021/06/12	66	%	50 - 130			
			Anthracene	2021/06/12	85	%	50 - 130			
			Benzo(a)anthracene	2021/06/12	82	%	50 - 130			
			Benzo(b&j)fluoranthene	2021/06/12	78	%	50 - 130			
			Benzo(k)fluoranthene	2021/06/12	81	%	50 - 130			
			Benzo(g,h,i)perylene	2021/06/12	77	%	50 - 130			
			Benzo(c)phenanthrene	2021/06/12	79	%	50 - 130			
			Benzo(a)pyrene	2021/06/12	89	%	50 - 130			
			Benzo(e)pyrene	2021/06/12	74	%	50 - 130			
			Chrysene	2021/06/12	78	%	50 - 130			
			Dibenz(a,h)anthracene	2021/06/12	80	%	50 - 130			
			Fluoranthene	2021/06/12	97	%	50 - 130			
			Fluorene	2021/06/12	102	%	50 - 130			
			Indeno(1,2,3-cd)pyrene	2021/06/12	82	%	50 - 130			
			1-Methylnaphthalene	2021/06/12	76	%	50 - 130			
			2-Methylnaphthalene	2021/06/12	95	%	50 - 130			
			Naphthalene	2021/06/12	96	%	50 - 130			
			Phenanthrene	2021/06/12	92	%	50 - 130			
			Perylene	2021/06/12	76	%	50 - 130			
			Pyrene	2021/06/12	96	%	50 - 130			
			Quinoline	2021/06/12	86	%	50 - 130			
			A251733	JU2	Spiked Blank	D10-ANTHRACENE (sur.)	2021/06/12	102	%	50 - 130
						D8-ACENAPHTHYLENE (sur.)	2021/06/12	98	%	50 - 130
						D8-NAPHTHALENE (sur.)	2021/06/12	86	%	50 - 130
TERPHENYL-D14 (sur.)	2021/06/12	91				%	50 - 130			
Acenaphthene	2021/06/12	94				%	50 - 130			
Acenaphthylene	2021/06/12	108				%	50 - 130			
Acridine	2021/06/12	74				%	50 - 130			
Anthracene	2021/06/12	90				%	50 - 130			
Benzo(a)anthracene	2021/06/12	90				%	50 - 130			
Benzo(b&j)fluoranthene	2021/06/12	88				%	50 - 130			
Benzo(k)fluoranthene	2021/06/12	90				%	50 - 130			
Benzo(g,h,i)perylene	2021/06/12	89				%	50 - 130			
Benzo(c)phenanthrene	2021/06/12	88				%	50 - 130			
Benzo(a)pyrene	2021/06/12	101				%	50 - 130			
Benzo(e)pyrene	2021/06/12	82				%	50 - 130			
Chrysene	2021/06/12	86				%	50 - 130			
Dibenz(a,h)anthracene	2021/06/12	87				%	50 - 130			
Fluoranthene	2021/06/12	101				%	50 - 130			
Fluorene	2021/06/12	106				%	50 - 130			
Indeno(1,2,3-cd)pyrene	2021/06/12	93				%	50 - 130			
1-Methylnaphthalene	2021/06/12	78	%	50 - 130						
2-Methylnaphthalene	2021/06/12	97	%	50 - 130						
Naphthalene	2021/06/12	99	%	50 - 130						
Phenanthrene	2021/06/12	97	%	50 - 130						
Perylene	2021/06/12	85	%	50 - 130						



BV Labs Job #: C138809
 Report Date: 2021/06/18

ASSOCIATED ENGINEERING ALBERTA LTD.
 Client Project #: 2021-3981.001.140
 Site Location: TERWILLIGAR DR STAGE 2
 Your P.O. #: 2021-3981.001-140
 Sampler Initials: RH

QUALITY ASSURANCE REPORT(CONT'D)

QA/QC Batch	Init	QC Type	Parameter	Date Analyzed	Value	Recovery	UNITS	QC Limits
A251733	JU2	Method Blank	Pyrene	2021/06/12		101	%	50 - 130
			Quinoline	2021/06/12		101	%	50 - 130
			D10-ANTHRACENE (sur.)	2021/06/12		107	%	50 - 130
			D8-ACENAPHTHYLENE (sur.)	2021/06/12		102	%	50 - 130
			D8-NAPHTHALENE (sur.)	2021/06/12		91	%	50 - 130
			TERPHENYL-D14 (sur.)	2021/06/12		100	%	50 - 130
			Acenaphthene	2021/06/12	<0.0050		mg/kg	
			Acenaphthylene	2021/06/12	<0.0050		mg/kg	
			Acridine	2021/06/12	<0.010		mg/kg	
			Anthracene	2021/06/12	<0.0040		mg/kg	
			Benzo(a)anthracene	2021/06/12	<0.0050		mg/kg	
			Benzo(b&j)fluoranthene	2021/06/12	<0.0050		mg/kg	
			Benzo(k)fluoranthene	2021/06/12	<0.0050		mg/kg	
			Benzo(g,h,i)perylene	2021/06/12	<0.0050		mg/kg	
			Benzo(c)phenanthrene	2021/06/12	<0.0050		mg/kg	
			Benzo(a)pyrene	2021/06/12	<0.0050		mg/kg	
			Benzo(e)pyrene	2021/06/12	<0.0050		mg/kg	
			Chrysene	2021/06/12	<0.0050		mg/kg	
			Dibenz(a,h)anthracene	2021/06/12	<0.0050		mg/kg	
			Fluoranthene	2021/06/12	<0.0050		mg/kg	
			Fluorene	2021/06/12	<0.0050		mg/kg	
Indeno(1,2,3-cd)pyrene	2021/06/12	<0.0050		mg/kg				
1-Methylnaphthalene	2021/06/12	<0.0050		mg/kg				
2-Methylnaphthalene	2021/06/12	<0.0050		mg/kg				
Naphthalene	2021/06/12	<0.0050		mg/kg				
Phenanthrene	2021/06/12	<0.0050		mg/kg				
Perylene	2021/06/12	<0.0050		mg/kg				
Pyrene	2021/06/12	<0.0050		mg/kg				
Quinoline	2021/06/12	<0.010		mg/kg				
A251733	JU2	RPD [ZY0019-02]	Acenaphthene	2021/06/12	NC		%	50
			Acenaphthylene	2021/06/12	NC		%	50
			Acridine	2021/06/12	NC		%	50
			Anthracene	2021/06/12	NC		%	50
			Benzo(a)anthracene	2021/06/12	NC		%	50
			Benzo(b&j)fluoranthene	2021/06/12	26		%	50
			Benzo(k)fluoranthene	2021/06/12	NC		%	50
			Benzo(g,h,i)perylene	2021/06/12	NC		%	50
			Benzo(c)phenanthrene	2021/06/12	NC		%	50
			Benzo(a)pyrene	2021/06/12	NC		%	50
			Benzo(e)pyrene	2021/06/12	NC		%	50
			Chrysene	2021/06/12	NC		%	50
			Dibenz(a,h)anthracene	2021/06/12	NC		%	50
			Fluoranthene	2021/06/12	NC		%	50
			Fluorene	2021/06/12	NC		%	50
			Indeno(1,2,3-cd)pyrene	2021/06/12	NC		%	50
			1-Methylnaphthalene	2021/06/12	NC		%	50
			2-Methylnaphthalene	2021/06/12	NC		%	50
			Naphthalene	2021/06/12	NC		%	50
			Phenanthrene	2021/06/12	NC		%	50
			Perylene	2021/06/12	42		%	50
Pyrene	2021/06/12	NC		%	50			
Quinoline	2021/06/12	NC		%	50			



QUALITY ASSURANCE REPORT(CONT'D)

QA/QC Batch	Init	QC Type	Parameter	Date Analyzed	Value	Recovery	UNITS	QC Limits
A251736	ARV	Method Blank	Moisture	2021/06/11	<0.30		%	
A251736	ARV	RPD	Moisture	2021/06/11	2.8		%	20
A251760	RIL	Method Blank	Moisture	2021/06/10	<0.30		%	
A251760	RIL	RPD	Moisture	2021/06/10	0.23		%	20
A251761	RIL	Method Blank	Moisture	2021/06/10	<0.30		%	
A251761	RIL	RPD [ZY0070-02]	Moisture	2021/06/10	0.52		%	20
A251762	RIL	Method Blank	Moisture	2021/06/11	<0.30		%	
A251762	RIL	RPD [ZY0095-02]	Moisture	2021/06/11	2.3		%	20
A251763	RIL	Method Blank	Moisture	2021/06/11	<0.30		%	
A251763	RIL	RPD	Moisture	2021/06/11	0		%	20
A252069	LZ3	QC Standard	Saturation %	2021/06/11		101	%	75 - 125
A252069	LZ3	RPD	Saturation %	2021/06/11	6.7		%	12
A252072	JHC	QC Standard	Soluble (CaCl2) pH	2021/06/11		99	%	98 - 102
A252072	JHC	Spiked Blank	Soluble (CaCl2) pH	2021/06/11		100	%	97 - 103
A252072	JHC	RPD	Soluble (CaCl2) pH	2021/06/11	0.16		%	N/A
A252074	STB	QC Standard	Saturation %	2021/06/12		106	%	75 - 125
A252074	STB	RPD [ZY0079-01]	Saturation %	2021/06/12	2.9		%	12
A252076	JHC	QC Standard	Soluble (CaCl2) pH	2021/06/11		99	%	98 - 102
A252076	JHC	Spiked Blank	Soluble (CaCl2) pH	2021/06/11		100	%	97 - 103
A252076	JHC	RPD [ZY0079-01]	Soluble (CaCl2) pH	2021/06/11	0.32		%	N/A
A252137	STB	QC Standard	Saturation %	2021/06/12		96	%	75 - 125
A252137	STB	RPD [ZY0089-01]	Saturation %	2021/06/12	6.1		%	12
A252145	JHC	QC Standard	Soluble (CaCl2) pH	2021/06/11		99	%	98 - 102
A252145	JHC	Spiked Blank	Soluble (CaCl2) pH	2021/06/11		100	%	97 - 103
A252145	JHC	RPD [ZY0089-01]	Soluble (CaCl2) pH	2021/06/11	0.018		%	N/A
A252324	RSU	Matrix Spike	1,4-Difluorobenzene (sur.)	2021/06/11		93	%	50 - 140
			4-Bromofluorobenzene (sur.)	2021/06/11		102	%	50 - 140
			D10-o-Xylene (sur.)	2021/06/11		138	%	50 - 140
			D4-1,2-Dichloroethane (sur.)	2021/06/11		105	%	50 - 140
			Benzene	2021/06/11		111	%	N/A
			Toluene	2021/06/11		106	%	N/A
			Ethylbenzene	2021/06/11		109	%	N/A
			m & p-Xylene	2021/06/11		106	%	N/A
			o-Xylene	2021/06/11		102	%	N/A
			F1 (C6-C10)	2021/06/11		102	%	N/A
A252324	RSU	Spiked Blank	1,4-Difluorobenzene (sur.)	2021/06/11		95	%	50 - 140
			4-Bromofluorobenzene (sur.)	2021/06/11		104	%	50 - 140
			D10-o-Xylene (sur.)	2021/06/11		119	%	50 - 140
			D4-1,2-Dichloroethane (sur.)	2021/06/11		105	%	50 - 140
			Benzene	2021/06/11		112	%	60 - 130
			Toluene	2021/06/11		108	%	60 - 130
			Ethylbenzene	2021/06/11		111	%	60 - 130
			m & p-Xylene	2021/06/11		107	%	60 - 130
			o-Xylene	2021/06/11		106	%	60 - 130
			F1 (C6-C10)	2021/06/11		85	%	60 - 140
A252324	RSU	Method Blank	1,4-Difluorobenzene (sur.)	2021/06/11		93	%	50 - 140
			4-Bromofluorobenzene (sur.)	2021/06/11		102	%	50 - 140
			D10-o-Xylene (sur.)	2021/06/11		118	%	50 - 140
			D4-1,2-Dichloroethane (sur.)	2021/06/11		103	%	50 - 140
			Benzene	2021/06/11	<0.0050		mg/kg	
			Toluene	2021/06/11	<0.050		mg/kg	
			Ethylbenzene	2021/06/11	<0.010		mg/kg	



QUALITY ASSURANCE REPORT(CONT'D)

QA/QC Batch	Init	QC Type	Parameter	Date Analyzed	Value	Recovery	UNITS	QC Limits			
A252324	RSU	RPD	m & p-Xylene	2021/06/11	<0.040		mg/kg				
			o-Xylene	2021/06/11	<0.020		mg/kg				
			F1 (C6-C10)	2021/06/11	<10		mg/kg				
			Benzene	2021/06/11	NC		%	50			
			Toluene	2021/06/11	NC		%	50			
			Ethylbenzene	2021/06/11	NC		%	50			
			m & p-Xylene	2021/06/11	NC		%	50			
			o-Xylene	2021/06/11	NC		%	50			
			F1 (C6-C10)	2021/06/11	NC		%	30			
			A252451	KHF	Matrix Spike	Hex. Chromium (Cr 6+)	2021/06/11		98	%	75 - 125
A252451	KHF	Spiked Blank	Hex. Chromium (Cr 6+)	2021/06/11		107	%	80 - 120			
A252451	KHF	Method Blank	Hex. Chromium (Cr 6+)	2021/06/11	<0.080		mg/kg				
A252451	KHF	RPD	Hex. Chromium (Cr 6+)	2021/06/11	NC		%	35			
A252489	BL7	QC Standard	Sieve - #200 (>0.075mm)	2021/06/11		105	%	75 - 125			
			Sieve - Pan	2021/06/11		98	%	75 - 125			
A252489	BL7	RPD	Sieve - #10 (>2.00mm)	2021/06/11	15		%	30			
			Sieve - #200 (>0.075mm)	2021/06/11	0.17		%	30			
			Sieve - Pan	2021/06/11	5.1		%	30			
			A252546	KHF	Matrix Spike [ZY0046-01]	Hex. Chromium (Cr 6+)	2021/06/11		104	%	75 - 125
A252546	KHF	Spiked Blank	Hex. Chromium (Cr 6+)	2021/06/11		108	%	80 - 120			
A252546	KHF	Method Blank	Hex. Chromium (Cr 6+)	2021/06/11	<0.080		mg/kg				
A252546	KHF	RPD [ZY0046-01]	Hex. Chromium (Cr 6+)	2021/06/11	NC		%	35			
A252581	PC5	Matrix Spike [ZY0074-01]	Total Antimony (Sb)	2021/06/12		86	%	75 - 125			
			Total Arsenic (As)	2021/06/12		88	%	75 - 125			
			Total Barium (Ba)	2021/06/12		NC	%	75 - 125			
			Total Beryllium (Be)	2021/06/12		98	%	75 - 125			
			Total Cadmium (Cd)	2021/06/12		96	%	75 - 125			
			Total Chromium (Cr)	2021/06/12		115	%	75 - 125			
			Total Cobalt (Co)	2021/06/12		94	%	75 - 125			
			Total Copper (Cu)	2021/06/12		91	%	75 - 125			
			Total Lead (Pb)	2021/06/12		95	%	75 - 125			
			Total Mercury (Hg)	2021/06/12		84	%	75 - 125			
			Total Molybdenum (Mo)	2021/06/12		98	%	75 - 125			
			Total Nickel (Ni)	2021/06/12		95	%	75 - 125			
			Total Selenium (Se)	2021/06/12		83	%	75 - 125			
			Total Silver (Ag)	2021/06/12		93	%	75 - 125			
			Total Thallium (Tl)	2021/06/12		93	%	75 - 125			
			Total Tin (Sn)	2021/06/12		97	%	75 - 125			
			Total Uranium (U)	2021/06/12		97	%	75 - 125			
			Total Vanadium (V)	2021/06/12		133 (2)	%	75 - 125			
			A252581	PC5	QC Standard	Total Zinc (Zn)	2021/06/12		NC	%	75 - 125
						Total Antimony (Sb)	2021/06/12		105	%	15 - 182
Total Arsenic (As)	2021/06/12					103	%	53 - 147			
Total Barium (Ba)	2021/06/12					97	%	80 - 119			
Total Cadmium (Cd)	2021/06/12					115	%	72 - 128			
Total Chromium (Cr)	2021/06/12					98	%	59 - 141			
Total Cobalt (Co)	2021/06/12					96	%	58 - 142			
Total Copper (Cu)	2021/06/12					102	%	83 - 117			
Total Lead (Pb)	2021/06/12					108	%	79 - 121			
Total Molybdenum (Mo)	2021/06/12					102	%	67 - 133			
Total Nickel (Ni)	2021/06/12					106	%	79 - 121			
Total Silver (Ag)	2021/06/12					103	%	47 - 153			



QUALITY ASSURANCE REPORT(CONT'D)

QA/QC Batch	Init	QC Type	Parameter	Date Analyzed	Value	Recovery	UNITS	QC Limits
A252581	PC5	Spiked Blank	Total Tin (Sn)	2021/06/12		96	%	67 - 133
			Total Uranium (U)	2021/06/12		93	%	77 - 123
			Total Vanadium (V)	2021/06/12		105	%	79 - 121
			Total Zinc (Zn)	2021/06/12		102	%	79 - 121
			Total Antimony (Sb)	2021/06/12		101	%	80 - 120
			Total Arsenic (As)	2021/06/12		93	%	80 - 120
			Total Barium (Ba)	2021/06/12		99	%	80 - 120
			Total Beryllium (Be)	2021/06/12		102	%	80 - 120
			Total Cadmium (Cd)	2021/06/12		94	%	80 - 120
			Total Chromium (Cr)	2021/06/12		99	%	80 - 120
			Total Cobalt (Co)	2021/06/12		97	%	80 - 120
			Total Copper (Cu)	2021/06/12		97	%	80 - 120
			Total Lead (Pb)	2021/06/12		98	%	80 - 120
			Total Mercury (Hg)	2021/06/12		91	%	80 - 120
			Total Molybdenum (Mo)	2021/06/12		99	%	80 - 120
			Total Nickel (Ni)	2021/06/12		98	%	80 - 120
			Total Selenium (Se)	2021/06/12		104	%	80 - 120
			Total Silver (Ag)	2021/06/12		94	%	80 - 120
			Total Thallium (Tl)	2021/06/12		101	%	80 - 120
			A252581	PC5	Method Blank	Total Tin (Sn)	2021/06/12	
Total Uranium (U)	2021/06/12					101	%	80 - 120
Total Vanadium (V)	2021/06/12					101	%	80 - 120
Total Zinc (Zn)	2021/06/12					98	%	80 - 120
Total Antimony (Sb)	2021/06/12	<0.50					mg/kg	
Total Arsenic (As)	2021/06/12	<1.0					mg/kg	
Total Barium (Ba)	2021/06/12	<1.0					mg/kg	
Total Beryllium (Be)	2021/06/12	<0.40					mg/kg	
Total Cadmium (Cd)	2021/06/12	<0.050					mg/kg	
Total Chromium (Cr)	2021/06/12	<1.0					mg/kg	
Total Cobalt (Co)	2021/06/12	<0.50					mg/kg	
Total Copper (Cu)	2021/06/12	<1.0					mg/kg	
Total Lead (Pb)	2021/06/12	<0.50					mg/kg	
Total Mercury (Hg)	2021/06/12	<0.050					mg/kg	
Total Molybdenum (Mo)	2021/06/12	<0.40					mg/kg	
Total Nickel (Ni)	2021/06/12	<1.0					mg/kg	
Total Selenium (Se)	2021/06/12	<0.50					mg/kg	
Total Silver (Ag)	2021/06/12	<0.20					mg/kg	
Total Thallium (Tl)	2021/06/12	<0.10					mg/kg	
A252581	PC5	RPD [ZY0074-01]				Total Tin (Sn)	2021/06/12	<1.0
			Total Uranium (U)	2021/06/12	<0.20		mg/kg	
			Total Vanadium (V)	2021/06/12	<1.0		mg/kg	
			Total Zinc (Zn)	2021/06/12	<10		mg/kg	
			Total Antimony (Sb)	2021/06/12	NC		%	30
			Total Arsenic (As)	2021/06/12	1.4		%	30
			Total Barium (Ba)	2021/06/12	6.3		%	35
			Total Beryllium (Be)	2021/06/12	4.4		%	30
			Total Cadmium (Cd)	2021/06/12	4.4		%	30
			Total Chromium (Cr)	2021/06/12	4.8		%	30
			Total Cobalt (Co)	2021/06/12	1.3		%	30
			Total Copper (Cu)	2021/06/12	5.5		%	30
			Total Lead (Pb)	2021/06/12	8.7		%	35
Total Mercury (Hg)	2021/06/12	NC		%	35			



BV Labs Job #: C138809
 Report Date: 2021/06/18

ASSOCIATED ENGINEERING ALBERTA LTD.
 Client Project #: 2021-3981.001.140
 Site Location: TERWILLIGAR DR STAGE 2
 Your P.O. #: 2021-3981.001-140
 Sampler Initials: RH

QUALITY ASSURANCE REPORT(CONT'D)

QA/QC Batch	Init	QC Type	Parameter	Date Analyzed	Value	Recovery	UNITS	QC Limits
			Total Molybdenum (Mo)	2021/06/12	1.0		%	35
			Total Nickel (Ni)	2021/06/12	1.4		%	30
			Total Selenium (Se)	2021/06/12	1.9		%	30
			Total Silver (Ag)	2021/06/12	NC		%	35
			Total Thallium (Tl)	2021/06/12	10		%	30
			Total Tin (Sn)	2021/06/12	NC		%	35
			Total Uranium (U)	2021/06/12	6.0		%	30
			Total Vanadium (V)	2021/06/12	2.5		%	30
			Total Zinc (Zn)	2021/06/12	2.9		%	30
A252785	PC5	Matrix Spike	Total Antimony (Sb)	2021/06/12		90	%	75 - 125
			Total Arsenic (As)	2021/06/12		90	%	75 - 125
			Total Barium (Ba)	2021/06/12		NC	%	75 - 125
			Total Beryllium (Be)	2021/06/12		89	%	75 - 125
			Total Cadmium (Cd)	2021/06/12		91	%	75 - 125
			Total Chromium (Cr)	2021/06/12		110	%	75 - 125
			Total Cobalt (Co)	2021/06/12		92	%	75 - 125
			Total Copper (Cu)	2021/06/12		88	%	75 - 125
			Total Lead (Pb)	2021/06/12		95	%	75 - 125
			Total Mercury (Hg)	2021/06/12		89	%	75 - 125
			Total Molybdenum (Mo)	2021/06/12		98	%	75 - 125
			Total Nickel (Ni)	2021/06/12		104	%	75 - 125
			Total Selenium (Se)	2021/06/12		93	%	75 - 125
			Total Silver (Ag)	2021/06/12		92	%	75 - 125
			Total Thallium (Tl)	2021/06/12		91	%	75 - 125
			Total Tin (Sn)	2021/06/12		94	%	75 - 125
			Total Uranium (U)	2021/06/12		91	%	75 - 125
			Total Vanadium (V)	2021/06/12		116	%	75 - 125
			Total Zinc (Zn)	2021/06/12		98	%	75 - 125
A252785	PC5	QC Standard	Total Antimony (Sb)	2021/06/12		103	%	15 - 182
			Total Arsenic (As)	2021/06/12		92	%	53 - 147
			Total Barium (Ba)	2021/06/12		97	%	80 - 119
			Total Cadmium (Cd)	2021/06/12		103	%	72 - 128
			Total Chromium (Cr)	2021/06/12		109	%	59 - 141
			Total Cobalt (Co)	2021/06/12		103	%	58 - 142
			Total Copper (Cu)	2021/06/12		107	%	83 - 117
			Total Lead (Pb)	2021/06/12		105	%	79 - 121
			Total Molybdenum (Mo)	2021/06/12		112	%	67 - 133
			Total Nickel (Ni)	2021/06/12		115	%	79 - 121
			Total Silver (Ag)	2021/06/12		100	%	47 - 153
			Total Tin (Sn)	2021/06/12		99	%	67 - 133
			Total Uranium (U)	2021/06/12		97	%	77 - 123
			Total Vanadium (V)	2021/06/12		110	%	79 - 121
			Total Zinc (Zn)	2021/06/12		105	%	79 - 121
A252785	PC5	Spiked Blank	Total Antimony (Sb)	2021/06/12		96	%	80 - 120
			Total Arsenic (As)	2021/06/12		97	%	80 - 120
			Total Barium (Ba)	2021/06/12		99	%	80 - 120
			Total Beryllium (Be)	2021/06/12		93	%	80 - 120
			Total Cadmium (Cd)	2021/06/12		96	%	80 - 120
			Total Chromium (Cr)	2021/06/12		102	%	80 - 120
			Total Cobalt (Co)	2021/06/12		102	%	80 - 120
			Total Copper (Cu)	2021/06/12		102	%	80 - 120
			Total Lead (Pb)	2021/06/12		99	%	80 - 120



BV Labs Job #: C138809
 Report Date: 2021/06/18

ASSOCIATED ENGINEERING ALBERTA LTD.
 Client Project #: 2021-3981.001.140
 Site Location: TERWILLIGAR DR STAGE 2
 Your P.O. #: 2021-3981.001-140
 Sampler Initials: RH

QUALITY ASSURANCE REPORT(CONT'D)

QA/QC Batch	Init	QC Type	Parameter	Date Analyzed	Value	Recovery	UNITS	QC Limits
			Total Mercury (Hg)	2021/06/12		99	%	80 - 120
			Total Molybdenum (Mo)	2021/06/12		103	%	80 - 120
			Total Nickel (Ni)	2021/06/12		101	%	80 - 120
			Total Selenium (Se)	2021/06/12		98	%	80 - 120
			Total Silver (Ag)	2021/06/12		97	%	80 - 120
			Total Thallium (Tl)	2021/06/12		97	%	80 - 120
			Total Tin (Sn)	2021/06/12		96	%	80 - 120
			Total Uranium (U)	2021/06/12		98	%	80 - 120
			Total Vanadium (V)	2021/06/12		102	%	80 - 120
			Total Zinc (Zn)	2021/06/12		99	%	80 - 120
A252785	PC5	Method Blank	Total Antimony (Sb)	2021/06/12	<0.50		mg/kg	
			Total Arsenic (As)	2021/06/12	<1.0		mg/kg	
			Total Barium (Ba)	2021/06/12	<1.0		mg/kg	
			Total Beryllium (Be)	2021/06/12	<0.40		mg/kg	
			Total Cadmium (Cd)	2021/06/12	<0.050		mg/kg	
			Total Chromium (Cr)	2021/06/12	<1.0		mg/kg	
			Total Cobalt (Co)	2021/06/12	<0.50		mg/kg	
			Total Copper (Cu)	2021/06/12	<1.0		mg/kg	
			Total Lead (Pb)	2021/06/12	<0.50		mg/kg	
			Total Mercury (Hg)	2021/06/12	<0.050		mg/kg	
			Total Molybdenum (Mo)	2021/06/12	<0.40		mg/kg	
			Total Nickel (Ni)	2021/06/12	<1.0		mg/kg	
			Total Selenium (Se)	2021/06/12	<0.50		mg/kg	
			Total Silver (Ag)	2021/06/12	<0.20		mg/kg	
			Total Thallium (Tl)	2021/06/12	<0.10		mg/kg	
			Total Tin (Sn)	2021/06/12	<1.0		mg/kg	
			Total Uranium (U)	2021/06/12	<0.20		mg/kg	
			Total Vanadium (V)	2021/06/12	<1.0		mg/kg	
			Total Zinc (Zn)	2021/06/12	<10		mg/kg	
A252857	PC5	Matrix Spike [ZY0024-01]	Total Antimony (Sb)	2021/06/12		90	%	75 - 125
			Total Arsenic (As)	2021/06/12		100	%	75 - 125
			Total Barium (Ba)	2021/06/12		NC	%	75 - 125
			Total Beryllium (Be)	2021/06/12		99	%	75 - 125
			Total Cadmium (Cd)	2021/06/12		101	%	75 - 125
			Total Chromium (Cr)	2021/06/12		119	%	75 - 125
			Total Cobalt (Co)	2021/06/12		105	%	75 - 125
			Total Copper (Cu)	2021/06/12		107	%	75 - 125
			Total Lead (Pb)	2021/06/12		104	%	75 - 125
			Total Mercury (Hg)	2021/06/12		97	%	75 - 125
			Total Molybdenum (Mo)	2021/06/12		109	%	75 - 125
			Total Nickel (Ni)	2021/06/12		116	%	75 - 125
			Total Selenium (Se)	2021/06/12		101	%	75 - 125
			Total Silver (Ag)	2021/06/12		100	%	75 - 125
			Total Thallium (Tl)	2021/06/12		98	%	75 - 125
			Total Tin (Sn)	2021/06/12		104	%	75 - 125
			Total Uranium (U)	2021/06/12		100	%	75 - 125
			Total Vanadium (V)	2021/06/12		122	%	75 - 125
			Total Zinc (Zn)	2021/06/12		NC	%	75 - 125
A252857	PC5	QC Standard	Total Antimony (Sb)	2021/06/12		113	%	15 - 182
			Total Arsenic (As)	2021/06/12		96	%	53 - 147
			Total Barium (Ba)	2021/06/12		97	%	80 - 119
			Total Cadmium (Cd)	2021/06/12		104	%	72 - 128



BV Labs Job #: C138809
 Report Date: 2021/06/18

ASSOCIATED ENGINEERING ALBERTA LTD.
 Client Project #: 2021-3981.001.140
 Site Location: TERWILLIGAR DR STAGE 2
 Your P.O. #: 2021-3981.001-140
 Sampler Initials: RH

QUALITY ASSURANCE REPORT(CONT'D)

QA/QC Batch	Init	QC Type	Parameter	Date Analyzed	Value	Recovery	UNITS	QC Limits
			Total Chromium (Cr)	2021/06/12		103	%	59 - 141
			Total Cobalt (Co)	2021/06/12		102	%	58 - 142
			Total Copper (Cu)	2021/06/12		101	%	83 - 117
			Total Lead (Pb)	2021/06/12		110	%	79 - 121
			Total Molybdenum (Mo)	2021/06/12		110	%	67 - 133
			Total Nickel (Ni)	2021/06/12		108	%	79 - 121
			Total Silver (Ag)	2021/06/12		83	%	47 - 153
			Total Tin (Sn)	2021/06/12		100	%	67 - 133
			Total Uranium (U)	2021/06/12		101	%	77 - 123
			Total Vanadium (V)	2021/06/12		108	%	79 - 121
			Total Zinc (Zn)	2021/06/12		104	%	79 - 121
A252857	PC5	Spiked Blank	Total Antimony (Sb)	2021/06/12		95	%	80 - 120
			Total Arsenic (As)	2021/06/12		95	%	80 - 120
			Total Barium (Ba)	2021/06/12		95	%	80 - 120
			Total Beryllium (Be)	2021/06/12		91	%	80 - 120
			Total Cadmium (Cd)	2021/06/12		95	%	80 - 120
			Total Chromium (Cr)	2021/06/12		99	%	80 - 120
			Total Cobalt (Co)	2021/06/12		100	%	80 - 120
			Total Copper (Cu)	2021/06/12		98	%	80 - 120
			Total Lead (Pb)	2021/06/12		97	%	80 - 120
			Total Mercury (Hg)	2021/06/12		99	%	80 - 120
			Total Molybdenum (Mo)	2021/06/12		102	%	80 - 120
			Total Nickel (Ni)	2021/06/12		98	%	80 - 120
			Total Selenium (Se)	2021/06/12		97	%	80 - 120
			Total Silver (Ag)	2021/06/12		96	%	80 - 120
			Total Thallium (Tl)	2021/06/12		95	%	80 - 120
			Total Tin (Sn)	2021/06/12		94	%	80 - 120
			Total Uranium (U)	2021/06/12		95	%	80 - 120
			Total Vanadium (V)	2021/06/12		100	%	80 - 120
			Total Zinc (Zn)	2021/06/12		96	%	80 - 120
A252857	PC5	Method Blank	Total Antimony (Sb)	2021/06/12	<0.50		mg/kg	
			Total Arsenic (As)	2021/06/12	<1.0		mg/kg	
			Total Barium (Ba)	2021/06/12	<1.0		mg/kg	
			Total Beryllium (Be)	2021/06/12	<0.40		mg/kg	
			Total Cadmium (Cd)	2021/06/12	<0.050		mg/kg	
			Total Chromium (Cr)	2021/06/12	<1.0		mg/kg	
			Total Cobalt (Co)	2021/06/12	<0.50		mg/kg	
			Total Copper (Cu)	2021/06/12	<1.0		mg/kg	
			Total Lead (Pb)	2021/06/12	<0.50		mg/kg	
			Total Mercury (Hg)	2021/06/12	<0.050		mg/kg	
			Total Molybdenum (Mo)	2021/06/12	<0.40		mg/kg	
			Total Nickel (Ni)	2021/06/12	<1.0		mg/kg	
			Total Selenium (Se)	2021/06/12	<0.50		mg/kg	
			Total Silver (Ag)	2021/06/12	<0.20		mg/kg	
			Total Thallium (Tl)	2021/06/12	<0.10		mg/kg	
			Total Tin (Sn)	2021/06/12	<1.0		mg/kg	
			Total Uranium (U)	2021/06/12	<0.20		mg/kg	
			Total Vanadium (V)	2021/06/12	<1.0		mg/kg	
			Total Zinc (Zn)	2021/06/12	<1.0		mg/kg	
A252857	PC5	RPD [ZY0024-01]	Total Antimony (Sb)	2021/06/12	0.058		%	30
			Total Arsenic (As)	2021/06/12	2.2		%	30
			Total Barium (Ba)	2021/06/12	0.87		%	35



QUALITY ASSURANCE REPORT(CONT'D)

QA/QC Batch	Init	QC Type	Parameter	Date Analyzed	Value	Recovery	UNITS	QC Limits
			Total Beryllium (Be)	2021/06/12	8.0		%	30
			Total Cadmium (Cd)	2021/06/12	3.3		%	30
			Total Chromium (Cr)	2021/06/12	2.5		%	30
			Total Cobalt (Co)	2021/06/12	0.026		%	30
			Total Copper (Cu)	2021/06/12	1.0		%	30
			Total Lead (Pb)	2021/06/12	0.44		%	35
			Total Mercury (Hg)	2021/06/12	0.66		%	35
			Total Molybdenum (Mo)	2021/06/12	0.43		%	35
			Total Nickel (Ni)	2021/06/12	1.9		%	30
			Total Selenium (Se)	2021/06/12	NC		%	30
			Total Silver (Ag)	2021/06/12	NC		%	35
			Total Thallium (Tl)	2021/06/12	4.3		%	30
			Total Tin (Sn)	2021/06/12	NC		%	35
			Total Uranium (U)	2021/06/12	1.9		%	30
			Total Vanadium (V)	2021/06/12	4.2		%	30
			Total Zinc (Zn)	2021/06/12	0.90		%	30
A252964	ZI	Matrix Spike [ZY0025-01]	Hex. Chromium (Cr 6+)	2021/06/12		89	%	75 - 125
A252964	ZI	Spiked Blank	Hex. Chromium (Cr 6+)	2021/06/12		106	%	80 - 120
A252964	ZI	Method Blank	Hex. Chromium (Cr 6+)	2021/06/12	<0.080		mg/kg	
A252964	ZI	RPD [ZY0025-01]	Hex. Chromium (Cr 6+)	2021/06/12	NC		%	35
A253026	ZI	Matrix Spike	Hex. Chromium (Cr 6+)	2021/06/12		93	%	75 - 125
A253026	ZI	Spiked Blank	Hex. Chromium (Cr 6+)	2021/06/12		103	%	80 - 120
A253026	ZI	Method Blank	Hex. Chromium (Cr 6+)	2021/06/12	<0.080		mg/kg	
A253026	ZI	RPD	Hex. Chromium (Cr 6+)	2021/06/12	NC		%	35
A253305	ZI	Matrix Spike	Hex. Chromium (Cr 6+)	2021/06/12		92	%	75 - 125
A253305	ZI	Spiked Blank	Hex. Chromium (Cr 6+)	2021/06/12		105	%	80 - 120
A253305	ZI	Method Blank	Hex. Chromium (Cr 6+)	2021/06/12	<0.080		mg/kg	
A253305	ZI	RPD	Hex. Chromium (Cr 6+)	2021/06/12	NC		%	35
A253314	PC5	Matrix Spike	Total Antimony (Sb)	2021/06/12		78	%	75 - 125
			Total Arsenic (As)	2021/06/12		91	%	75 - 125
			Total Barium (Ba)	2021/06/12		NC	%	75 - 125
			Total Beryllium (Be)	2021/06/12		92	%	75 - 125
			Total Cadmium (Cd)	2021/06/12		92	%	75 - 125
			Total Chromium (Cr)	2021/06/12		149 (2)	%	75 - 125
			Total Cobalt (Co)	2021/06/12		96	%	75 - 125
			Total Copper (Cu)	2021/06/12		94	%	75 - 125
			Total Lead (Pb)	2021/06/12		93	%	75 - 125
			Total Mercury (Hg)	2021/06/12		85	%	75 - 125
			Total Molybdenum (Mo)	2021/06/12		96	%	75 - 125
			Total Nickel (Ni)	2021/06/12		106	%	75 - 125
			Total Selenium (Se)	2021/06/12		96	%	75 - 125
			Total Silver (Ag)	2021/06/12		90	%	75 - 125
			Total Thallium (Tl)	2021/06/12		91	%	75 - 125
			Total Tin (Sn)	2021/06/12		92	%	75 - 125
			Total Uranium (U)	2021/06/12		91	%	75 - 125
			Total Vanadium (V)	2021/06/12		NC	%	75 - 125
			Total Zinc (Zn)	2021/06/12		NC	%	75 - 125
A253314	PC5	QC Standard	Total Antimony (Sb)	2021/06/12		115	%	15 - 182
			Total Arsenic (As)	2021/06/12		103	%	53 - 147
			Total Barium (Ba)	2021/06/12		99	%	80 - 119
			Total Cadmium (Cd)	2021/06/12		110	%	72 - 128
			Total Chromium (Cr)	2021/06/12		106	%	59 - 141



BV Labs Job #: C138809
 Report Date: 2021/06/18

ASSOCIATED ENGINEERING ALBERTA LTD.
 Client Project #: 2021-3981.001.140
 Site Location: TERWILLIGAR DR STAGE 2
 Your P.O. #: 2021-3981.001-140
 Sampler Initials: RH

QUALITY ASSURANCE REPORT(CONT'D)

QA/QC Batch	Init	QC Type	Parameter	Date Analyzed	Value	Recovery	UNITS	QC Limits
			Total Cobalt (Co)	2021/06/12		101	%	58 - 142
			Total Copper (Cu)	2021/06/12		104	%	83 - 117
			Total Lead (Pb)	2021/06/12		107	%	79 - 121
			Total Molybdenum (Mo)	2021/06/12		107	%	67 - 133
			Total Nickel (Ni)	2021/06/12		109	%	79 - 121
			Total Silver (Ag)	2021/06/12		82	%	47 - 153
			Total Tin (Sn)	2021/06/12		97	%	67 - 133
			Total Uranium (U)	2021/06/12		99	%	77 - 123
			Total Vanadium (V)	2021/06/12		110	%	79 - 121
			Total Zinc (Zn)	2021/06/12		106	%	79 - 121
A253314	PC5	Spiked Blank	Total Antimony (Sb)	2021/06/12		99	%	80 - 120
			Total Arsenic (As)	2021/06/12		103	%	80 - 120
			Total Barium (Ba)	2021/06/12		99	%	80 - 120
			Total Beryllium (Be)	2021/06/12		99	%	80 - 120
			Total Cadmium (Cd)	2021/06/12		102	%	80 - 120
			Total Chromium (Cr)	2021/06/12		107	%	80 - 120
			Total Cobalt (Co)	2021/06/12		108	%	80 - 120
			Total Copper (Cu)	2021/06/12		107	%	80 - 120
			Total Lead (Pb)	2021/06/12		104	%	80 - 120
			Total Mercury (Hg)	2021/06/12		101	%	80 - 120
			Total Molybdenum (Mo)	2021/06/12		107	%	80 - 120
			Total Nickel (Ni)	2021/06/12		108	%	80 - 120
			Total Selenium (Se)	2021/06/12		104	%	80 - 120
			Total Silver (Ag)	2021/06/12		101	%	80 - 120
			Total Thallium (Tl)	2021/06/12		100	%	80 - 120
			Total Tin (Sn)	2021/06/12		100	%	80 - 120
			Total Uranium (U)	2021/06/12		102	%	80 - 120
			Total Vanadium (V)	2021/06/12		107	%	80 - 120
			Total Zinc (Zn)	2021/06/12		108	%	80 - 120
A253314	PC5	Method Blank	Total Antimony (Sb)	2021/06/12	<0.50		mg/kg	
			Total Arsenic (As)	2021/06/12	<1.0		mg/kg	
			Total Barium (Ba)	2021/06/12	<1.0		mg/kg	
			Total Beryllium (Be)	2021/06/12	<0.40		mg/kg	
			Total Cadmium (Cd)	2021/06/12	<0.050		mg/kg	
			Total Chromium (Cr)	2021/06/12	<1.0		mg/kg	
			Total Cobalt (Co)	2021/06/12	<0.50		mg/kg	
			Total Copper (Cu)	2021/06/12	<1.0		mg/kg	
			Total Lead (Pb)	2021/06/12	<0.50		mg/kg	
			Total Mercury (Hg)	2021/06/12	<0.050		mg/kg	
			Total Molybdenum (Mo)	2021/06/12	<0.40		mg/kg	
			Total Nickel (Ni)	2021/06/12	<1.0		mg/kg	
			Total Selenium (Se)	2021/06/12	<0.50		mg/kg	
			Total Silver (Ag)	2021/06/12	<0.20		mg/kg	
			Total Thallium (Tl)	2021/06/12	<0.10		mg/kg	
			Total Tin (Sn)	2021/06/12	<1.0		mg/kg	
			Total Uranium (U)	2021/06/12	<0.20		mg/kg	
			Total Vanadium (V)	2021/06/12	<1.0		mg/kg	
			Total Zinc (Zn)	2021/06/12	<1.0		mg/kg	
A253314	PC5	RPD	Total Antimony (Sb)	2021/06/12	1.9		%	30
			Total Arsenic (As)	2021/06/12	1.0		%	30
			Total Barium (Ba)	2021/06/12	33		%	35
			Total Beryllium (Be)	2021/06/12	2.7		%	30



QUALITY ASSURANCE REPORT(CONT'D)

QA/QC Batch	Init	QC Type	Parameter	Date Analyzed	Value	Recovery	UNITS	QC Limits
			Total Cadmium (Cd)	2021/06/12	5.1		%	30
			Total Chromium (Cr)	2021/06/12	1.1		%	30
			Total Cobalt (Co)	2021/06/12	5.0		%	30
			Total Copper (Cu)	2021/06/12	0.41		%	30
			Total Lead (Pb)	2021/06/12	1.5		%	35
			Total Mercury (Hg)	2021/06/12	6.2		%	35
			Total Molybdenum (Mo)	2021/06/12	1.9		%	35
			Total Nickel (Ni)	2021/06/12	0.54		%	30
			Total Selenium (Se)	2021/06/12	5.1		%	30
			Total Silver (Ag)	2021/06/12	NC		%	35
			Total Thallium (Tl)	2021/06/12	0.58		%	30
			Total Tin (Sn)	2021/06/12	NC		%	35
			Total Uranium (U)	2021/06/12	0.99		%	30
			Total Vanadium (V)	2021/06/12	2.0		%	30
			Total Zinc (Zn)	2021/06/12	0.77		%	30
A253354	JAB	Matrix Spike [ZY0079-01]	Soluble Boron (B)	2021/06/12		97	%	75 - 125
			Soluble Calcium (Ca)	2021/06/12		95	%	75 - 125
			Soluble Magnesium (Mg)	2021/06/12		97	%	75 - 125
			Soluble Sodium (Na)	2021/06/12		NC	%	75 - 125
A253354	JAB	QC Standard	Soluble Potassium (K)	2021/06/12		100	%	75 - 125
			Soluble Calcium (Ca)	2021/06/12		106	%	75 - 125
			Soluble Magnesium (Mg)	2021/06/12		102	%	75 - 125
			Soluble Sodium (Na)	2021/06/12		99	%	75 - 125
			Soluble Potassium (K)	2021/06/12		109	%	75 - 125
			Soluble Sulphate (SO4)	2021/06/12		111	%	75 - 125
A253354	JAB	Spiked Blank	Soluble Boron (B)	2021/06/12		96	%	80 - 120
			Soluble Calcium (Ca)	2021/06/12		100	%	80 - 120
			Soluble Magnesium (Mg)	2021/06/12		99	%	80 - 120
			Soluble Sodium (Na)	2021/06/12		94	%	80 - 120
			Soluble Potassium (K)	2021/06/12		101	%	80 - 120
A253354	JAB	Method Blank	Soluble Boron (B)	2021/06/12	<0.10		mg/L	
			Soluble Calcium (Ca)	2021/06/12	<1.5		mg/L	
			Soluble Magnesium (Mg)	2021/06/12	<1.0		mg/L	
			Soluble Sodium (Na)	2021/06/12	<2.5		mg/L	
			Soluble Potassium (K)	2021/06/12	<1.3		mg/L	
			Soluble Sulphate (SO4)	2021/06/12	<5.0		mg/L	
A253354	JAB	RPD [ZY0079-01]	Soluble Boron (B)	2021/06/12	NC		%	30
			Soluble Calcium (Ca)	2021/06/12	9.6		%	30
			Soluble Magnesium (Mg)	2021/06/12	14		%	30
			Soluble Sodium (Na)	2021/06/12	11		%	30
			Soluble Potassium (K)	2021/06/12	7.1		%	30
			Soluble Sulphate (SO4)	2021/06/12	7.2		%	30
A253394	ZI	Matrix Spike [ZY0079-01]	Soluble Chloride (Cl)	2021/06/12		NC	%	75 - 125
A253394	ZI	QC Standard	Soluble Chloride (Cl)	2021/06/12		107	%	75 - 125
A253394	ZI	Spiked Blank	Soluble Chloride (Cl)	2021/06/12		107	%	80 - 120
A253394	ZI	Method Blank	Soluble Chloride (Cl)	2021/06/12	<10		mg/L	
A253394	ZI	RPD [ZY0079-01]	Soluble Chloride (Cl)	2021/06/12	17		%	30
A253395	ZI	Matrix Spike [ZY0089-01]	Soluble Chloride (Cl)	2021/06/12		NC	%	75 - 125
A253395	ZI	QC Standard	Soluble Chloride (Cl)	2021/06/12		103	%	75 - 125
A253395	ZI	Spiked Blank	Soluble Chloride (Cl)	2021/06/12		101	%	80 - 120
A253395	ZI	Method Blank	Soluble Chloride (Cl)	2021/06/12	<10		mg/L	
A253395	ZI	RPD [ZY0089-01]	Soluble Chloride (Cl)	2021/06/12	24		%	30



QUALITY ASSURANCE REPORT(CONT'D)

QA/QC Batch	Init	QC Type	Parameter	Date Analyzed	Value	Recovery	UNITS	QC Limits
A253396	ZI	Matrix Spike	Soluble Chloride (Cl)	2021/06/12		100	%	75 - 125
A253396	ZI	QC Standard	Soluble Chloride (Cl)	2021/06/12		101	%	75 - 125
A253396	ZI	Spiked Blank	Soluble Chloride (Cl)	2021/06/12		107	%	80 - 120
A253396	ZI	Method Blank	Soluble Chloride (Cl)	2021/06/12	<10		mg/L	
A253396	ZI	RPD	Soluble Chloride (Cl)	2021/06/12	6.2		%	30
A253422	JAB	Matrix Spike	Soluble Boron (B)	2021/06/12		96	%	75 - 125
			Soluble Calcium (Ca)	2021/06/12		100	%	75 - 125
			Soluble Magnesium (Mg)	2021/06/12		98	%	75 - 125
			Soluble Sodium (Na)	2021/06/12		94	%	75 - 125
			Soluble Potassium (K)	2021/06/12		100	%	75 - 125
A253422	JAB	QC Standard	Soluble Calcium (Ca)	2021/06/12		106	%	75 - 125
			Soluble Magnesium (Mg)	2021/06/12		101	%	75 - 125
			Soluble Sodium (Na)	2021/06/12		99	%	75 - 125
			Soluble Potassium (K)	2021/06/12		98	%	75 - 125
			Soluble Sulphate (SO4)	2021/06/12		111	%	75 - 125
A253422	JAB	Spiked Blank	Soluble Boron (B)	2021/06/12		97	%	80 - 120
			Soluble Calcium (Ca)	2021/06/12		100	%	80 - 120
			Soluble Magnesium (Mg)	2021/06/12		99	%	80 - 120
			Soluble Sodium (Na)	2021/06/12		94	%	80 - 120
			Soluble Potassium (K)	2021/06/12		100	%	80 - 120
A253422	JAB	Method Blank	Soluble Boron (B)	2021/06/12	<0.10		mg/L	
			Soluble Calcium (Ca)	2021/06/12	<1.5		mg/L	
			Soluble Magnesium (Mg)	2021/06/12	<1.0		mg/L	
			Soluble Sodium (Na)	2021/06/12	<2.5		mg/L	
			Soluble Potassium (K)	2021/06/12	<1.3		mg/L	
			Soluble Sulphate (SO4)	2021/06/12	<5.0		mg/L	
A253422	JAB	RPD	Soluble Boron (B)	2021/06/12	NC		%	30
			Soluble Calcium (Ca)	2021/06/12	16		%	30
			Soluble Magnesium (Mg)	2021/06/12	19		%	30
			Soluble Sodium (Na)	2021/06/12	11		%	30
			Soluble Potassium (K)	2021/06/12	2.9		%	30
			Soluble Sulphate (SO4)	2021/06/12	27		%	30
A253423	JAB	Matrix Spike [ZY0089-01]	Soluble Boron (B)	2021/06/12		100	%	75 - 125
			Soluble Calcium (Ca)	2021/06/12		99	%	75 - 125
			Soluble Magnesium (Mg)	2021/06/12		99	%	75 - 125
			Soluble Sodium (Na)	2021/06/12		NC	%	75 - 125
			Soluble Potassium (K)	2021/06/12		101	%	75 - 125
A253423	JAB	QC Standard	Soluble Calcium (Ca)	2021/06/12		107	%	75 - 125
			Soluble Magnesium (Mg)	2021/06/12		105	%	75 - 125
			Soluble Sodium (Na)	2021/06/12		104	%	75 - 125
			Soluble Potassium (K)	2021/06/12		93	%	75 - 125
			Soluble Sulphate (SO4)	2021/06/12		116	%	75 - 125
A253423	JAB	Spiked Blank	Soluble Boron (B)	2021/06/12		101	%	80 - 120
			Soluble Calcium (Ca)	2021/06/12		101	%	80 - 120
			Soluble Magnesium (Mg)	2021/06/12		99	%	80 - 120
			Soluble Sodium (Na)	2021/06/12		97	%	80 - 120
			Soluble Potassium (K)	2021/06/12		102	%	80 - 120
A253423	JAB	Method Blank	Soluble Boron (B)	2021/06/12	<0.10		mg/L	
			Soluble Calcium (Ca)	2021/06/12	<1.5		mg/L	
			Soluble Magnesium (Mg)	2021/06/12	<1.0		mg/L	
			Soluble Sodium (Na)	2021/06/12	<2.5		mg/L	
			Soluble Potassium (K)	2021/06/12	<1.3		mg/L	



QUALITY ASSURANCE REPORT(CONT'D)

QA/QC Batch	Init	QC Type	Parameter	Date Analyzed	Value	Recovery	UNITS	QC Limits
A253423	JAB	RPD [ZY0089-01]	Soluble Sulphate (SO4)	2021/06/12	<5.0		mg/L	
			Soluble Boron (B)	2021/06/13	19		%	30
			Soluble Calcium (Ca)	2021/06/13	2.1		%	30
			Soluble Magnesium (Mg)	2021/06/13	15		%	30
			Soluble Sodium (Na)	2021/06/13	29		%	30
			Soluble Potassium (K)	2021/06/13	27		%	30
A253467	STB	QC Standard	Soluble Sulphate (SO4)	2021/06/13	19		%	30
			Soluble Conductivity	2021/06/12		105	%	75 - 125
A253467	STB	Spiked Blank	Soluble Conductivity	2021/06/12		99	%	90 - 110
A253467	STB	Method Blank	Soluble Conductivity	2021/06/12	<0.020		dS/m	
A253467	STB	RPD	Soluble Conductivity	2021/06/12	11		%	20
A253565	STB	QC Standard	Soluble Conductivity	2021/06/13		110	%	75 - 125
A253565	STB	Spiked Blank	Soluble Conductivity	2021/06/13		101	%	90 - 110
A253565	STB	Method Blank	Soluble Conductivity	2021/06/13	<0.020		dS/m	
A253565	STB	RPD [ZY0089-01]	Soluble Conductivity	2021/06/13	15		%	20
A253586	STB	QC Standard	Soluble Conductivity	2021/06/13		106	%	75 - 125
A253586	STB	Spiked Blank	Soluble Conductivity	2021/06/13		101	%	90 - 110
A253586	STB	Method Blank	Soluble Conductivity	2021/06/13	<0.020		dS/m	
A253586	STB	RPD [ZY0079-01]	Soluble Conductivity	2021/06/13	6.7		%	20
A254075	JLJ	Spiked Blank	F4G-SG (Heavy Hydrocarbons-Grav.)	2021/06/14		100	%	60 - 140
A254075	JLJ	Method Blank	F4G-SG (Heavy Hydrocarbons-Grav.)	2021/06/14	<500		mg/kg	
A259017	YPL	Matrix Spike	13C2-Perfluorodecanoic acid	2021/06/16		77	%	50 - 150
			13C2-Perfluorododecanoic acid	2021/06/16		49 (3)	%	50 - 150
			13C2-Perfluorohexanoic acid	2021/06/16		90	%	50 - 150
			13C2-perfluorotetradecanoic acid	2021/06/16		12 (4)	%	50 - 150
			13C2-Perfluoroundecanoic acid	2021/06/16		67	%	50 - 150
			13C3-Perfluorobutanesulfonic acid	2021/06/16		89	%	50 - 150
			13C4-Perfluorobutanoic acid	2021/06/16		89	%	50 - 150
			13C4-Perfluoroheptanoic acid	2021/06/16		90	%	50 - 150
			13C4-Perfluorooctanesulfonic acid	2021/06/16		81	%	50 - 150
			13C4-Perfluorooctanoic acid	2021/06/16		89	%	50 - 150
			13C5-Perfluorononanoic acid	2021/06/16		89	%	50 - 150
			13C5-Perfluoropentanoic acid	2021/06/16		89	%	50 - 150
			13C8-Perfluorooctane Sulfonamide	2021/06/16		71	%	50 - 150
			18O2-Perfluorohexanesulfonic acid	2021/06/16		89	%	50 - 150
			Perfluorobutanoic acid	2021/06/16		74	%	70 - 130
			Perfluoropentanoic Acid (PFPeA)	2021/06/16		76	%	70 - 130
			Perfluorohexanoic Acid (PFHxA)	2021/06/16		76	%	70 - 130
			Perfluoroheptanoic Acid (PFHpA)	2021/06/16		75	%	70 - 130
			Perfluorooctanoic Acid (PFOA)	2021/06/16		73	%	70 - 130
			Perfluorononanoic Acid (PFNA)	2021/06/16		72	%	70 - 130
			Perfluorodecanoic Acid (PFDA)	2021/06/16		77	%	70 - 130
			Perfluoroundecanoic Acid (PFUnA)	2021/06/16		73	%	70 - 130
			Perfluorododecanoic Acid (PFDoA)	2021/06/16		74	%	70 - 130
			Perfluorotridecanoic Acid	2021/06/16		163 (5)	%	70 - 130
			Perfluorotetradecanoic Acid	2021/06/16		73	%	70 - 130
			Perfluorobutanesulfonic acid	2021/06/16		75	%	70 - 130
			Perfluoropentanesulfonic acid	2021/06/16		76	%	70 - 130
Perfluorohexanesulfonic acid	2021/06/16		76	%	70 - 130			
Perfluoroheptanesulfonic acid	2021/06/16		72	%	70 - 130			
Perfluorooctanesulfonic acid	2021/06/16		77	%	70 - 130			
Perfluorononane sulfonic acid	2021/06/16		63 (6)	%	70 - 130			



QUALITY ASSURANCE REPORT(CONT'D)

QA/QC Batch	Init	QC Type	Parameter	Date Analyzed	Value	Recovery	UNITS	QC Limits
A259017	YPL	Spiked Blank	Perfluorodecanesulfonic acid (PFDS)	2021/06/16		57 (6)	%	70 - 130
			Perfluorooctane Sulfonamide (PFOSA)	2021/06/16		72	%	70 - 130
			13C2-Perfluorodecanoic acid	2021/06/16		86	%	50 - 150
			13C2-Perfluorododecanoic acid	2021/06/16		86	%	50 - 150
			13C2-Perfluorohexanoic acid	2021/06/16		91	%	50 - 150
			13C2-perfluorotetradecanoic acid	2021/06/16		78	%	50 - 150
			13C2-Perfluoroundecanoic acid	2021/06/16		86	%	50 - 150
			13C3-Perfluorobutanesulfonic acid	2021/06/16		89	%	50 - 150
			13C4-Perfluorobutanoic acid	2021/06/16		91	%	50 - 150
			13C4-Perfluoroheptanoic acid	2021/06/16		90	%	50 - 150
			13C4-Perfluorooctanesulfonic acid	2021/06/16		88	%	50 - 150
			13C4-Perfluorooctanoic acid	2021/06/16		90	%	50 - 150
			13C5-Perfluorononanoic acid	2021/06/16		91	%	50 - 150
			13C5-Perfluoropentanoic acid	2021/06/16		92	%	50 - 150
			13C8-Perfluorooctane Sulfonamide	2021/06/16		81	%	50 - 150
			18O2-Perfluorohexanesulfonic acid	2021/06/16		90	%	50 - 150
			Perfluorobutanoic acid	2021/06/16		72	%	70 - 130
			Perfluoropentanoic Acid (PFPeA)	2021/06/16		73	%	70 - 130
			Perfluorohexanoic Acid (PFHxA)	2021/06/16		75	%	70 - 130
			Perfluoroheptanoic Acid (PFHpA)	2021/06/16		74	%	70 - 130
			Perfluorooctanoic Acid (PFOA)	2021/06/16		72	%	70 - 130
			Perfluorononanoic Acid (PFNA)	2021/06/16		73	%	70 - 130
			Perfluorodecanoic Acid (PFDA)	2021/06/16		74	%	70 - 130
			Perfluoroundecanoic Acid (PFUnA)	2021/06/16		73	%	70 - 130
			Perfluorododecanoic Acid (PFDoA)	2021/06/16		72	%	70 - 130
			Perfluorotridecanoic Acid	2021/06/16		76	%	70 - 130
			Perfluorotetradecanoic Acid	2021/06/16		74	%	70 - 130
			Perfluorobutanesulfonic acid	2021/06/16		74	%	70 - 130
			Perfluoropentanesulfonic acid	2021/06/16		73	%	70 - 130
			Perfluorohexanesulfonic acid	2021/06/16		74	%	70 - 130
			Perfluoroheptanesulfonic acid	2021/06/16		72	%	70 - 130
			Perfluorooctanesulfonic acid	2021/06/16		75	%	70 - 130
Perfluorononane sulfonic acid	2021/06/16		70	%	70 - 130			
Perfluorodecanesulfonic acid (PFDS)	2021/06/16		72	%	70 - 130			
Perfluorooctane Sulfonamide (PFOSA)	2021/06/16		74	%	70 - 130			
A259017	YPL	Method Blank	13C2-Perfluorodecanoic acid	2021/06/16		89	%	50 - 150
			13C2-Perfluorododecanoic acid	2021/06/16		85	%	50 - 150
			13C2-Perfluorohexanoic acid	2021/06/16		100	%	50 - 150
			13C2-perfluorotetradecanoic acid	2021/06/16		79	%	50 - 150
			13C2-Perfluoroundecanoic acid	2021/06/16		86	%	50 - 150
			13C3-Perfluorobutanesulfonic acid	2021/06/16		95	%	50 - 150
			13C4-Perfluorobutanoic acid	2021/06/16		98	%	50 - 150
			13C4-Perfluoroheptanoic acid	2021/06/16		98	%	50 - 150
			13C4-Perfluorooctanesulfonic acid	2021/06/16		89	%	50 - 150
			13C4-Perfluorooctanoic acid	2021/06/16		95	%	50 - 150
			13C5-Perfluorononanoic acid	2021/06/16		97	%	50 - 150
			13C5-Perfluoropentanoic acid	2021/06/16		100	%	50 - 150
			13C8-Perfluorooctane Sulfonamide	2021/06/16		82	%	50 - 150
			18O2-Perfluorohexanesulfonic acid	2021/06/16		95	%	50 - 150
Perfluorobutanoic acid	2021/06/16		<1.0		ug/kg			
Perfluoropentanoic Acid (PFPeA)	2021/06/16		<1.0		ug/kg			
Perfluorohexanoic Acid (PFHxA)	2021/06/16		<1.0		ug/kg			



QUALITY ASSURANCE REPORT(CONT'D)

QA/QC Batch	Init	QC Type	Parameter	Date Analyzed	Value	Recovery	UNITS	QC Limits
			Perfluoroheptanoic Acid (PFHpA)	2021/06/16	<1.0		ug/kg	
			Perfluorooctanoic Acid (PFOA)	2021/06/16	<1.0		ug/kg	
			Perfluorononanoic Acid (PFNA)	2021/06/16	<1.0		ug/kg	
			Perfluorodecanoic Acid (PFDA)	2021/06/16	<1.0		ug/kg	
			Perfluoroundecanoic Acid (PFUnA)	2021/06/16	<1.0		ug/kg	
			Perfluorododecanoic Acid (PFDoA)	2021/06/16	<1.0		ug/kg	
			Perfluorotridecanoic Acid	2021/06/16	<1.0		ug/kg	
			Perfluorotetradecanoic Acid	2021/06/16	<1.0		ug/kg	
			Perfluorobutanesulfonic acid	2021/06/16	<1.0		ug/kg	
			Perfluoropentanesulfonic acid	2021/06/16	<1.0		ug/kg	
			Perfluorohexanesulfonic acid	2021/06/16	<1.0		ug/kg	
			Perfluoroheptanesulfonic acid	2021/06/16	<1.0		ug/kg	
			Perfluorooctanesulfonic acid	2021/06/16	<1.0		ug/kg	
			Perfluorononane sulfonic acid	2021/06/16	<1.0		ug/kg	
			Perfluorodecanesulfonic acid (PFDS)	2021/06/16	<1.0		ug/kg	
			Perfluorooctane Sulfonamide (PFOSA)	2021/06/16	<1.0		ug/kg	

N/A = Not Applicable

Duplicate: Paired analysis of a separate portion of the same sample. Used to evaluate the variance in the measurement.

Matrix Spike: A sample to which a known amount of the analyte of interest has been added. Used to evaluate sample matrix interference.

QC Standard: A sample of known concentration prepared by an external agency under stringent conditions. Used as an independent check of method accuracy.

Spiked Blank: A blank matrix sample to which a known amount of the analyte, usually from a second source, has been added. Used to evaluate method accuracy.

Method Blank: A blank matrix containing all reagents used in the analytical procedure. Used to identify laboratory contamination.

Surrogate: A pure or isotopically labeled compound whose behavior mirrors the analytes of interest. Used to evaluate extraction efficiency.

NC (Matrix Spike): The recovery in the matrix spike was not calculated. The relative difference between the concentration in the parent sample and the spike amount was too small to permit a reliable recovery calculation (matrix spike concentration was less than the native sample concentration)

NC (Duplicate RPD): The duplicate RPD was not calculated. The concentration in the sample and/or duplicate was too low to permit a reliable RPD calculation (absolute difference <= 2x RDL).

(1) Detection limit raised due to interferent.

(2) Recovery or RPD for this parameter is outside control limits. The overall quality control for this analysis meets acceptability criteria.

(3) Extracted internal standard analyte recovery was below the defined lower control limit (LCL). Laboratory spiked soil resulted in satisfactory recovery of the extracted internal standard analyte. When considered together, these QC data suggest that matrix interferences may be increasing the variability of the associated native analyte result (PFDoA).

(4) Extracted internal standard analyte recovery was below the defined lower control limit (LCL). Laboratory spiked soil resulted in satisfactory recovery of the extracted internal standard analyte. When considered together, these QC data suggest that matrix interferences may be increasing the variability of the associated native analyte result (PFTeDA, PFTrDA).

(5) Recovery of the matrix spike was above the upper control limit. Laboratory spiked soil resulted in satisfactory recovery of the compound of interest. When considered together, these QC data suggest that matrix interferences may be biasing the data high. For results that were not detected (ND), this potential bias has no impact.

(6) Recovery of the matrix spike was below the lower control limit. Laboratory spiked soil resulted in satisfactory recovery of the compound of interest. When considered together, these QC data suggest that matrix interferences may be biasing the data low.



VALIDATION SIGNATURE PAGE

The analytical data and all QC contained in this report were reviewed and validated by:

Anastasiya Hamanov, Scientific Specialist

Colm McNamara, Senior Analyst, Liquid Chromatography

Ghayasuddin Khan, M.Sc., P.Chem., QP, Scientific Specialist, Inorganics

Gita Pokhrel, Laboratory Supervisor

Janet Gao, B.Sc., QP, Supervisor, Organics

Veronica Falk, B.Sc., P.Chem., QP, Scientific Specialist, Organics

BV Labs has procedures in place to guard against improper use of the electronic signature and have the required "signatories", as per ISO/IEC 17025, signing the reports. For Service Group specific validation please refer to the Validation Signature Page.



166(4) / 1663

CHAIN OF CUSTODY RECORD

INVOICE TO:		REPORT TO:		PROJECT INFORMATION:		Laboratory Use Only:	
Company Name: 88178 ASSOCIATED ENGINEERING ALBERTA LTD.	Company Name: Associated En	Qualification #:	BY Labs Job #:	2021-3981.001-140		Bottle Order #:	
Account: Accounts Payable, Brent Schmidt	Analyst: Danielle Loiseau / Richard Henschel	Project #:	2021-3981.001-140	C138809		Barcode:	
Address: 500 - 9888 Jasper Avenue Edmonton AB T5J 5C6	Address: 500 - 9888 Jasper Avenue Edmonton AB T5J 5C6	Project Name:	Terwilliger Dr Stage 2	COC #:		Project Manager:	
Tel: (780) 451-7666 Fax: (780) 454-7668	Tel: 780-913-1949 Fax:	Site #:		Barcode:		Customer Solutions:	
Email: accounts-payable@ae.ca; schmidt@ae.ca	Email: loiseau@ae.ca; henschel@ae.ca; schmidt@ae.ca	Sampled By:	Richard Henschel / DL	C4637640 01 01			

Regulatory Criteria: <input checked="" type="checkbox"/> ATI <input type="checkbox"/> CCME <input type="checkbox"/> Other	Special Instructions	ANALYSIS REQUESTED (PLEASE BE SPECIFIC)						Turnaround Time (TAT) Required	
		Metals Field Filtered (Y/N)	ATI BTEX and F-1-F4 in Soil (Y/N)	AT Metals & Salinity in Soil	PAH in Soil by GC/MS	PFAS in soil by SPE/LC-MS/MS	PFOS and PFOA in soil by SPE/LC/MS	Regular (Standard) TAT: (will be applied if Rush TAT is not specified) Standard TAT = 5-7 Working days for most tests. Please note: Standard TAT for bottom tests are > 5 days - contact your Project Manager for details.	<input checked="" type="checkbox"/>
SAMPLES MUST BE KEPT COOL (< 10°C) FROM TIME OF SAMPLING UNTIL DELIVERY TO BV LABS		Job Specific Rush TAT (if applies to entire submission) Date Required: _____ Rush Confirmation Number: _____						<input type="checkbox"/>	

Sample Barcode Label	Sample (Location) Identification	Date Sampled	Time Sampled	Matrix	Metals Field Filtered (Y/N)	ATI BTEX and F-1-F4 in Soil (Y/N)	AT Metals & Salinity in Soil	PAH in Soil by GC/MS	PFAS in soil by SPE/LC-MS/MS	PFOS and PFOA in soil by SPE/LC/MS	Hold	# of Tests	Comments
21HA01(0.0-0.3m)		21-06-02		SOIL							X HOLD	4	
21HA01(0.6-1.0m)		↓		SOIL									
21HA02(0.0-0.3m)		21-06-03		SOIL									
21HA02(0.6-1.0m)		↓		SOIL									
21HA03(0.0-0.3m)		↓		SOIL									
21HA03(0.6-1.0m)		↓		SOIL									
21HA04(0.0-0.3m)		21-06-02		SOIL									
21HA04(0.6-1.0m)		↓		SOIL									
21HA05(0.0-0.3m)		21-06-03		SOIL									
21HA05(0.6-1.0m)		↓		SOIL									

* RELINQUISHED BY: (Signature/Print) Richard Henschel	Date: (YYMMDD) 21/06/04	Time:	RECEIVED BY: (Signature/Print) Richard Austin Roberts Manel Saucedra	Date: (YYMMDD) 21/06/04	Time: 16:57	# Jars used and not submitted:	Laboratory Use Only: Temperature (°C) on Receipt: See ActR	Custody Seal Intact on Delivery: <input type="checkbox"/> Yes <input type="checkbox"/> No
---	-----------------------------------	-------	--	-----------------------------------	-----------------------	--------------------------------	---	--

* UNLESS OTHERWISE AGREED TO IN WRITING, WORK SUBMITTED ON THIS CHAIN OF CUSTODY IS SUBJECT TO BV'S STANDARD TERMS AND CONDITIONS. SIGNING OF THIS CHAIN OF CUSTODY DOCUMENT IS ACKNOWLEDGMENT AND ACCEPTANCE OF OUR TERMS WHICH ARE AVAILABLE FOR VIEWING AT WWW.BV.COM/TERMS-AND-CONDITIONS.
 * IT IS THE RESPONSIBILITY OF THE RELINQUISHER TO ENSURE THE ACCURACY OF THE CHAIN OF CUSTODY RECORD. AN INCOMPLETE CHAIN OF CUSTODY MAY RESULT IN ANALYTICAL TAT DELAYS.
 ** ALL SAMPLES ARE HELD FOR 90 DAYS AFTER SAMPLE RECEIPT. FOR SPECIAL REQUESTS CONTACT YOUR PROJECT MANAGER.

MCHC Refer to ActR



CHAIN OF CUSTODY RECORD

INVOICE TO:		REPORT TO:		PROJECT INFORMATION:		Laboratory Use Only:	
Company Name: #6176 ASSOCIATED ENGINEERING ALBERTA LTD.	Company Name:	Client/Ref:	Client/Ref:	Project:	Project:	BY Lab Job #:	Bottle Order #:
Address: Accounts Payable	Address: Danielle Loisele	Site #:	Site #:	Project Name:	Project Name:	QC#:	Project Manager:
Address: 500 - 9889 Jasper Avenue	Address:	Sampled by:	Sampled by:	QC#:	QC#:	QC#:	Customer Solutions:
Edmonton AB T6J 5C8	Edmonton AB T6J 5C8						
Tel: (780) 451-7686 Fax: (780) 454-7696	Tel:						
Email: accounts-payable@ae.ca	Email: loiseled@ae.ca						

Regulatory Criteria <input type="checkbox"/> ATI <input type="checkbox"/> CCME <input type="checkbox"/> Other	Special Instructions 	ANALYSIS REQUESTED (PLEASE BE SPECIFIC) Metals Field Filtered ? (Y/N) _____ ATI BTEX and F1-F4 in Soil (Vials) _____ ATI Metals & Salinity in Soil _____ PAH in Soil by GC/MS _____ PFAS in soil by SPEL/C-MS/MS _____ PFOS and PFOA in soil by SPEL/CMS _____ HOLD	Turnaround Time (TAT) Required: Please provide advance notice for rush projects Regular (Standard) TAT: (will be Applied if Rush TAT is not specified) Standard TAT = 5-7 Working days for most tests. Please note: Standard TAT for certain tests are > 5 days - contact your Project Manager for details.
---	-------------------------------------	---	--

SAMPLES MUST BE KEPT COOL (< 10°C) FROM TIME OF SAMPLING UNTIL DELIVERY TO BV LABS.						Metals Field Filtered ? (Y/N)	ATI BTEX and F1-F4 in Soil (Vials)	ATI Metals & Salinity in Soil	PAH in Soil by GC/MS	PFAS in soil by SPEL/C-MS/MS	PFOS and PFOA in soil by SPEL/CMS	HOLD	# of Bottles	Comments
Sample Barcode Label	Sample Location/Identification	Date Sampled	Time Sampled	Matrix										
21HA06(0.0-0.3m)		21-06-03		SOIL								4		
21HA06(0.6-1.0m)				SOIL										
21HA07(0.0-0.3m)				SOIL										
21HA07(0.6-1.0m)				SOIL										
21HA08(0.0-0.3m)				SOIL										
21HA08(0.6-1.0m)				SOIL										
21HA09(0.0-0.3m)		21-06-03		SOIL										
21HA09(0.6-1.0m)				SOIL										
21HA10(0.0-0.3m)		21-06-03		SOIL										
21HA10(0.6-1.0m)				SOIL										

RELINQUISHED BY: (Signature/Print)	Date: (YYMMDD)	Time	RECEIVED BY: (Signature/Print)	Date: (YYMMDD)	Time	# Jars used and not submitted	Time Delivered	Temperature (°C) on Receipt	Directly Sealed into Cooler?
			Austin Roberts	21/06/04	16:57			See ACTR	<input type="checkbox"/> Yes <input type="checkbox"/> No
			Marnel Scuderi	2021/06/05	15:30				

* UNLESS OTHERWISE AGREED TO IN WRITING, WORK SUBMITTED ON THIS CHAIN OF CUSTODY IS SUBJECT TO BV LABS' STANDARD TERMS AND CONDITIONS. SIGNING OF THIS CHAIN OF CUSTODY DOCUMENT IS ACKNOWLEDGMENT AND ACCEPTANCE OF OUR TERMS WHICH ARE AVAILABLE FOR VIEWING AT WWW.BVLABS.COM/TERMS-AND-CONDITIONS.
 ** IT IS THE RESPONSIBILITY OF THE RELINQUISHER TO ENSURE THE ACCURACY OF THE CHAIN OF CUSTODY RECORD. AN INCOMPLETE CHAIN OF CUSTODY MAY RESULT IN ANALYTICAL TAT DELAYS.
 *** ALL SAMPLES ARE HELD FOR 90 DAYS AFTER SAMPLE REPORT. FOR SPECIAL REQUESTS CONTACT YOUR PROJECT MANAGER.

MCAR Refer to ACTR



CHAIN OF CUSTODY RECORD

INVOICE TO:		REPORT TO:		PROJECT INFORMATION:		Laboratory Use Only:	
Company Name: #6176 ASSOCIATED ENGINEERING ALBERTA LTD.	Company Name: Daniela Loisel	Capitol #:	SV Lab Job #:	Order #:	Order #:	Order #:	Order #:
Account: Accounts Payable	Address: Edmonton AB T5J 5C6	Project: 2021-3981.001 - 140	DOC #:	C138809	Barcode:	Barcode:	Barcode:
Tel: (780) 451-7666 Fax: (780) 454-7698	Tel: loisel@dse.ca	Site #:	Sampled By:	Barcode:	Barcode:	Barcode:	Barcode:
Email: accounts-payable@ae.ca				Barcode:	Barcode:	Barcode:	Barcode:

Regulatory Criteria: <input type="checkbox"/> ATI <input type="checkbox"/> CCME <input type="checkbox"/> Other	Special Instructions: 	ANALYSIS REQUESTED (PLEASE BE SPECIFIC):						Turnaround Time (TAT) Required: Please provide advance notice for rush projects	
		Metals Field Filtered * (Y/N)	ATI BTEX and FI-F4 in Soil (Metals)	ATI Metals & Salinity in Soil	PAH in Soil by GC/MS	PFAS in soil by SPE/LC-MS/MS	PFOS and PFOA in soil by SPE/LC/MS	<input type="checkbox"/> Regular (Standard) TAT: (will be applied if Rush TAT is not specified) Standard TAT = 5-7 Working days for most tests. Please note: Standard TAT for certain tests are > 5 days - contact your Project Manager for details.	<input type="checkbox"/> Job Specific (Rush) TAT (if applies to entire submission) Date Required: _____ Rush Confirmation Number: _____

SAMPLES MUST BE KEPT COOL (< 10°C) FROM TIME OF SAMPLING UNTIL DELIVERY TO BV LABS										
Sample Barcode Label	Sample (Location) Identification	Date Sampled	Time Sampled	Matrix	Metals Field Filtered * (Y/N)	ATI BTEX and FI-F4 in Soil (Metals)	ATI Metals & Salinity in Soil	PAH in Soil by GC/MS	PFAS in soil by SPE/LC-MS/MS	PFOS and PFOA in soil by SPE/LC/MS
21HA11(0.0-0.3m)		21-06-03		SOIL						X
21HA11(0.6-1.0m)				SOIL						
21HA12(0.0-0.3m)				SOIL						
21HA12(0.6-1.0m)				SOIL						
21HA13(0.0-0.3m)		21-06-04	10:00	SOIL						
21HA13(1.0-1.3m)			10:00	SOIL						
21HA14(0.0-0.3m)			11:00	SOIL						
21HA14(1.0-1.3m)			11:00	SOIL						
21HA15(0.0-0.3m)			12:00	SOIL						
21HA15(1.0-1.3m)			12:00	SOIL						

RELINQUISHED BY: (Signature/Print)	Date: (YYMM/DD)	Time	RECEIVED BY: (Signature/Print)	Date: (YYMM/DD)	Time	# jars used and not submitted	Laboratory Use Only
			Austin Roberts	21/06/04	1657		Time Deviate: <input type="checkbox"/> Temperature (°C) on Receipt: 5°C ACTR
			ES McInnes	2021/06/05	15:30		Checkly Seal Intact on Cooler?: <input type="checkbox"/> Yes <input type="checkbox"/> No

* UNLESS OTHERWISE AGREED TO IN WRITING, WORK SUBMITTED ON THIS CHAIN OF CUSTODY IS SUBJECT TO BUREAU VERITAS STANDARD TERMS AND CONDITIONS. VISORS OF THIS CHAIN OF CUSTODY DOCUMENT IS ACKNOWLEDGMENT AND ACCEPTANCE OF OUR TERMS WHICH ARE AVAILABLE FOR VIEWING AT WWW.BVLABS.COM/TERMS-AND-CONDITIONS.
 ** IT IS THE RESPONSIBILITY OF THE RELINQUISHER TO ENSURE THE ACCURACY OF THE CHAIN OF CUSTODY RECORD. AN INCOMPLETE CHAIN OF CUSTODY MAY RESULT IN ANALYTICAL TAT DELAYS.
 *** ALL SAMPLES ARE HELD FOR 90 DAYS AFTER SAMPLE RECEIPT. FOR SPECIAL REQUESTS CONTACT YOUR PROJECT MANAGER.

MALAL REPLY to ACTR



CHAIN OF CUSTODY RECORD

INVOICE TO:		REPORT TO:		PROJECT INFORMATION:		Laboratory Use Only:	
Company Name: #0176 ASSOCIATED ENGINEERING ALBERTA LTD.	Company Name:	Danielle Lonselle		Division #:		BV Lab# Job #:	Batch Order #:
Attention: Accounts Payable	Address:	500 - 5858 Jasper Avenue		City #:		C138809	037640
Address: Edmonton AB T5J 5C6	Address:	Edmonton AB T5J 5C6		Project:	2021-3987.001.140		
Tel: (780) 451-7666 Fax: (780) 454-7898	Tel:			Site #:			Customs Solutions:
Email: accounts-payable@ae.ca	Email:	loiselle@ae.ca		Sampled By:			08107445.04.01

Regulatory Criteria: <input type="checkbox"/> All <input type="checkbox"/> CCME <input type="checkbox"/> Other	Special Instructions: 	ANALYSIS REQUESTED (PLEASE BE SPECIFIC)										Turnaround Time (TAT) Required: Please provide advance notice for rush projects	
		Metals Field Filtered (Y/N)	AT1 BTEX and F1-F4 in Soil (Weiss)	AT1 Metals & Salinity in Soil	PAH in Soil by GC/MS	PFAS in soil by SPELAC-MS/MS	PFOS and PFOA in soil by SPEL/MS	HOLD	<input type="checkbox"/> Regular (Standard) TAT: <small>(not to be applied if Rush TAT is not specified)</small> Standard TAT = 5-7 Working days for most tests. Please note: Standard TAT for certain tests are > 3 days - contact your Project Manager for details.	<input type="checkbox"/> Job Specific Rush TAT (if applies to entire submission) Date Required: _____ Rush Confirmation Number: _____			

SAMPLES MUST BE KEPT COOL (< 10°C) FROM TIME OF SAMPLING UNTIL DELIVERY TO BV LABS

Sample Barcode Label	Sample (Location) Identification	Date Sampled	Time Sampled	Matrix	Metals Field Filtered (Y/N)	AT1 BTEX and F1-F4 in Soil (Weiss)	AT1 Metals & Salinity in Soil	PAH in Soil by GC/MS	PFAS in soil by SPELAC-MS/MS	PFOS and PFOA in soil by SPEL/MS	Other	# of Tubes	Comments
21HA16(0.0-0.3m)		21-06-04		SOIL								4	
21HA16(0.6-1.0m)		↓		SOIL									
21HA17(0.0-0.3m)		↓		SOIL									
21HA17(0.6-1.0m)		↓		SOIL									
21HA18(0.0-0.3m)		21-06-03		SOIL									
21HA18(0.6-1.0m)		↓		SOIL									
21HA19(0.0-0.3m)		21-06-04		SOIL									
21HA19(0.6-1.0m)		↓		SOIL									
21HA20(0.0-0.3m)		21-06-03		SOIL									
21HA20(0.6-1.0m)		↓		SOIL									

* RELINQUISHED BY: (Signature/Print)		Date: (YYMM/DD)	Time	RECEIVED BY: (Signature/Print)		Date: (YYMM/DD)	Time	# jars used and not submitted	Laboratory Use Only	
<i>Manel Saeedra</i>				<i>Austina Roberts</i>		21/06/04	16:57		Time Inactive: <input type="checkbox"/>	Temperature (°C) on Receipt: <i>See AETR</i>
						2021/06/05	15:30		Custody Seal Intact on Delivery? <input type="checkbox"/> Yes <input type="checkbox"/> No	

NEAR Refer to AETR

* UNLESS OTHERWISE AGREED TO IN WRITING, WORK SUBMITTED ON THIS CHAIN OF CUSTODY IS SUBJECT TO BV LABORATORY TERMS AND CONDITIONS. SIGNING OF THIS CHAIN OF CUSTODY DOCUMENT IS ACKNOWLEDGMENT AND ACCEPTANCE OF OUR TERMS WHICH ARE AVAILABLE FOR VIEWING AT WWW.BVLABS.COM/TERMS AND CONDITIONS.
 * IT IS THE RESPONSIBILITY OF THE RELINQUISHER TO ENSURE THE ACCURACY OF THE CHAIN OF CUSTODY RECORD. AN INCOMPLETE CHAIN OF CUSTODY MAY RESULT IN ANALYTICAL TAT DELAYS.
 ** ALL SAMPLES ARE HELD FOR 90 DAYS AFTER SAMPLE RECEIPT. FOR SPECIAL REQUESTS CONTACT YOUR PROJECT MANAGER



CHAIN OF CUSTODY RECORD

INVOICE TO:		REPORT TO:		PROJECT INFORMATION:		Laboratory Use Only:	
Company Name: #6176 ASSOCIATED ENGINEERING ALBERTA LTD	Company Name:	Client Name: Danielle L. Olesie	Client ID:	Order Ref:	BY Lab# A/B#:	Batch Order #:	
Address: Accounts Payable 500 - 9888 Jasper Avenue Edmonton AB T5J 5C8	Address:	Address:	Project: 2021-3987.001.140	Project Name:	C138809	637540	
Tel: (780) 451-7668 Fax: (780) 454-7598	Tel:	Fax:	Site #:	Sampled By:	COC #:	Project Manager:	
Email: accounts-payable@ae.ca	Email: loiselle@ae.ca					Customer Solutions	

Regulatory Criteria: <input type="checkbox"/> ATI <input type="checkbox"/> COME <input type="checkbox"/> Other		Special Instructions: 		ANALYSIS REQUESTED (PLEASE BE SPECIFIC)										Turnaround Time (TAT) Required: Please provide advance notice for rush projects														
SAMPLES MUST BE REPT COOL (< 10°C) FROM TIME OF SAMPLING UNTIL DELIVERY TO BY LABS				Merge Field Filtered ? (Y/N)	AT1 BTEX and F1-F4 in Soil (Volis)	AT1 Metals & Salinity in Soil	PAH in Soil by GC/MS	PFAS in soil by SPE/LC-MS/MS	PFOS and PFOA in soil by SPE/LCMS	HOLD	X	4	Comments	<input type="checkbox"/> Regular (Standard) TAT: <small>(will be applied if Rush TAT is not specified)</small> Standard TAT = 5-7 Working days for most tests. *Please note: Standard TAT for certain tests are > 5 days - contact your Project Manager for details.		<input type="checkbox"/> Job Specific Rush TAT (if applies to entire submission) Date Required: _____ Rush Confirmation Number: _____ <small>(our lab for #)</small>												
Sample Barcode Label	Sample Location Identifier	Date Sampled	Time Sampled											Matrix														
1 21HA21(0.0-0.3m)		26-06-02												SOIL														
2 21HA21(0.6-1.0m)		↓												SOIL														
3 21HA22(0.0-0.3m)		↓												SOIL														
4 21HA22(0.6-1.0m)		↓												SOIL														
5 21HA23(0.0-0.3m)		21-06-02												SOIL														
6 21HA23(0.0-0.3m) → 21HA23(0.6-1.0m)		↓												SOIL														
7 21HA24(0.0-0.3m)		↓												SOIL														
8 21HA24(0.6-1.0m)		↓												SOIL														
9 21HA25(0.0-0.3m)		21-06-02		SOIL																								
10 21HA25(0.6-1.0m)		↓		SOIL																								
* RELINQUISHED BY: (Signature/Print)		Date: (YYMMDD)	Time	RECEIVED BY: (Signature/Print)		Date: (YYMMDD)	Time	# Jars used and not submitted	<input type="checkbox"/> Freezer Storage <input checked="" type="checkbox"/> Impurities (PC) on Recept		Laboratory Use Only <input type="checkbox"/> Ductility (See Interaction Checklist)		<input type="checkbox"/> Yes <input type="checkbox"/> No															
				[Signature] Austin [Signature] [Signature] Michael [Signature]		21/06/04	16:57		See ACTR																			
* THESE OTHERWISE ADDED TO IS WRITING, WORK SIGNATURE ON THIS CHAIN OF CUSTODY IS SUBJECT TO BY LABS'S STANDARD TERMS AND CONDITIONS. SIGNING OF THIS CHAIN OF CUSTODY DOCUMENT IS ACKNOWLEDGMENT AND ACCEPTANCE OF OUR TERMS WHICH ARE AVAILABLE FOR VIEWING AT WWW.BVLABS.COM/TERMS.AND.CONDITIONS.															* IT IS THE RESPONSIBILITY OF THE RELINQUISHER TO ENSURE THE ACCURACY OF THE CHAIN OF CUSTODY RECORD. AN INCOMPLETE CHAIN OF CUSTODY MAY RESULT IN ANALYTICAL TAT DELAYS.													
** ALL SAMPLES ARE HELD FOR 90 DAYS AFTER SAMPLE RECEIPT, FOR SPECIAL REQUESTS CONTACT YOUR PROJECT MANAGER.															* Max. 20 Labels Yellow Client													

NOTE Refer to ACTR



CHAIN OF CUSTODY RECORD

INVOICE TO:		REPORT TO:		PROJECT INFORMATION:		Laboratory Use Only:	
Company Name: #9175 ASSOCIATED ENGINEERING ALBERTA LTD.	Company Name: _____	Account: Accounts Payable	Person: Danielle Lussick	Location: _____	Client: _____	IV Lab Job #: C138809	Batch Order #: _____
Address: 500 - 9880 Jasper Avenue Edmonton AB T5J 5C6	Address: _____	Tel: (780) 451-7666	Tel: _____	Project: 2021-3987.001.140	Project Name: _____	COC #: _____	Project Manager: _____
Fax: (780) 454-7698	Fax: _____	Email: accounts-payable@ae.ca	Email: dlanled@ae.ca	Site #: _____	Sample By: _____		Customer Solutions

Regulatory Criteria <input type="checkbox"/> AT1 <input type="checkbox"/> CCME <input type="checkbox"/> Other: _____	Special Instructions 	ANALYSIS REQUESTED (IF FAST OR SPECIFIC)						Turnaround Time (TAT) Required Please provide advance notice for rush projects	
		Metals Field (Lead 7 (Y/N)) AT1 BTEX and F1-F4 in Soil (Walls) AT1 Metals & Salinity in Soil PNH in Soil by GC/MS PFAS in soil by SPE/LC-MS/MS PFOS and PFOA in soil by SPE/LC/MS	<input type="checkbox"/> Regular (Standard) TAT: (will be applied if Rush TAT is not specified) Standard TAT = 5-7 Working Days for most tests. Please note: Expedited TAT for certain tests are + 3 days - contact your Project Manager for details.	<input type="checkbox"/> Job Specific Rush TAT (if applies to entire submission) Date Required: _____ Rush Confirmation Number: _____					

SAMPLES MUST BE KEPT COOL (+ 10°C) FROM TIME OF SAMPLING UNTIL DELIVERY TO BV LABS					Metals Field (Lead 7 (Y/N))	AT1 BTEX and F1-F4 in Soil (Walls)	AT1 Metals & Salinity in Soil	PNH in Soil by GC/MS	PFAS in soil by SPE/LC-MS/MS	PFOS and PFOA in soil by SPE/LC/MS	TAT (days)	Comments
Sample No	Sample Location/Identification	Date Sampled	Time Sampled	Matrix								
1	21HA26(0.0-0.3m)	26-08-02		SOIL							4	
2	21HA26(0.6-1.0m)			SOIL								
3	21HA27(0.0-0.3m)			SOIL								
4	21HA27(0.6-1.0m)			SOIL								
5	21HA28(0.0-0.3m)			SOIL								
6	21HA28(0.6-0.9m)			SOIL								
7	21HA29(0.0-0.3m)	26-08-02		SOIL								
8	21HA29(0.6-1.0m)			SOIL								
9	21HA30(0.0-0.3m)			SOIL								
10	21HA30(0.6-1.0m)			SOIL								

RECEIVED BY: (Signature/Print) Austin Roberts K.S. Manuel Signature	Date: (YY/MM/DD) 21/06/04	Time 1657	# jars used and not submitted <input type="checkbox"/>	Laboratory Use Only Temperature (°C) on Receipt See ACTA	Consolidated Test Results Order? <input type="checkbox"/> Yes <input type="checkbox"/> No
--	-------------------------------------	---------------------	--	--	---

* UNLESS OTHERWISE AGREED TO IN WRITING, WORK SUBMITTED BY THIS CHAIN OF CUSTODY IS SUBJECT TO BV LABS STANDARD TERMS AND CONDITIONS. SIGNING OF THIS CHAIN OF CUSTODY CONSTITUTES AN ACKNOWLEDGMENT AND ACCEPTANCE OF OUR TERMS WHICH ARE AVAILABLE FOR VIEWING AT WWW.BVLABS.COM/TERMS-AND-CONDITIONS.
 * IT IS THE RESPONSIBILITY OF THE RELINQUISHER TO ENSURE THE ACCURACY OF THE CHAIN OF CUSTODY RECORD. AN INCOMPLETE CHAIN OF CUSTODY MAY RESULT IN ANALYTICAL TEST DELAYS.
 * ALL SAMPLES ARE HELD FOR 60 DAYS AFTER SAMPLE RECEIPT. FOR SPECIAL REQUESTS CONTACT YOUR PROJECT MANAGER.

NOTE Refer to ACTA



CHAIN OF CUSTODY RECORD

INVOICE TO:		REPORT TO:		PROJECT INFORMATION:		Laboratory Use Only:	
Company Name: 85176 ASSOCIATED ENGINEERING ALBERTA LTD.		Company Name: Tharble L. Smith		Quotation #		BY Lab's Job #	
Address: Accounts Payable		Address:		P.O. #		Order #	
Address: 530 - 9859 Jasper Avenue		Address:		Project: 2021-388 001 + 150		C-138809	
Address: Edmonton AB T5J 5C6		Address:		Project Name:		CCP #:	
Tel: (780) 451-7666 Fax: (780) 454-7668		Tel:		Site #		Project Manager:	
Email: accounts-payable@ae.ca		Email: lsmith@ae.ca		Accepted by:		Customer Solutions	

Regulatory Criteria <input type="checkbox"/> ATI <input type="checkbox"/> CCME <input type="checkbox"/> Other		Special Instructions 		ANALYSIS REQUESTED (PLEASE BE SPECIFIC) Metals Field Filtered * (Y/N)										Turnaround Time (TAT) Required Please provide advance notice for rush projects											
				AT1 BTEX and P1-P4 in Soil (Vials) AT1 Metals & Salinity in Soil PAH in Soil by GC/MS PFAS in soil by SPE/LC-MS/MS PCBs and PCFA in soil by SPE/LCMS HOLD										Regular (Standard) TAT: (will be applied if Rush TAT is not specified) Standard TAT = 5-7 Working days for most tests. Please note: Element 137 for vials in soil are + 5 days - contact your Project Manager for details. <input type="checkbox"/>											
														Job Specific Rush TAT (if applies to entire submission) Date Required: _____ <input type="checkbox"/>											
SAMPLES MUST BE KEPT COOL (< 10°C) FROM TIME OF SAMPLING UNTIL DELIVERY TO BV LABS														Rush Customer Number: _____ <input type="checkbox"/>											
Sample Bottle Label 1 DUP1 2 Dup2 3 Dup3 4 Dup4		Sample Describing Identifier 		Date Sampled 21-06-05		Time Sampled 		Matrix SOIL		Metals Field Filtered * (Y/N)		AT1 BTEX and P1-P4 in Soil (Vials)		AT1 Metals & Salinity in Soil		PAH in Soil by GC/MS		PFAS in soil by SPE/LC-MS/MS		PCBs and PCFA in soil by SPE/LCMS		HOLD		Turnaround Time (TAT) Required # of Bottles 4 4 4 4	

* RELINQUISHED BY: (Signature/Print)		Date: (YYMMDD)		Time		RECEIVED BY: (Signature/Print)		Date: (YYMMDD)		Time		# Jars used and well submitted		Temperature (°C) in Sample		Quality Seal (used in Closet)	
						Austin Roberts		21/06/05		16:57				See ACTR		<input type="checkbox"/> Yes <input type="checkbox"/> No	
						Michael Sarnedra		21/06/05		15:30							

* UNLESS OTHERWISE AGREED TO IN WRITING, WORK SUBMITTED ON THIS CHAIN OF CUSTODY IS SUBJECT TO BV LABS' STANDARD TERMS AND CONDITIONS. HOUSING OF THIS CHAIN OF CUSTODY DOCUMENT IS AN ACKNOWLEDGMENT AND ACCEPTANCE OF OUR TERMS WHICH ARE AVAILABLE FOR VIEWING AT WWW.BVLABS.COM/TERMS-AND-CONDITIONS.
 * IT IS THE RESPONSIBILITY OF THE RELINQUISHER TO ENSURE THE ACCURACY OF THE CHAIN OF CUSTODY RECORD. AN INCOMPLETE CHAIN OF CUSTODY MAY RESULT IN ANALYTICAL SET-BACKS.
 ** ALL SAMPLES ARE HELD FOR 30 DAYS AFTER SAMPLE RECEIPT. FOR SPECIAL REQUESTS CONTACT YOUR PROJECT MANAGER.

ALL See ACTR

APPENDIX F - CONTAMINATED SOILS MANAGEMENT STRATEGY

Issue Date: November 18, 2021 File No.: 2021-3981
To: Reg Ball Previous Issue Date: _____
From: Brent Schmidt, P.Geo Project No.: 2021-3981
Client: CIMA+
Project Name: Terwillegar Drive Stage 2
Subject: Contaminated Soils Management Strategy

Dear Reg:

1 INTRODUCTION

Associated Engineering (Associated) was retained by CIMA+ to develop a Contaminated Soil Management Strategy (CSMS) which outlines measures to effectively manage both clean and contaminated soil generated through the excavation works associated with the Terwillegar Drive Stage 2 Upgrades and Rainbow Valley Bridge Renewal (the Project). The Project area includes a 4.9 km segment of Whitemud Drive (WMD) freeway from the Fox Drive interchange to 122 Street NW interchange in Edmonton, Alberta (Figure 1).

In 2020, Associated completed a Limited Phase I Environmental Site Assessment (ESA)¹ for the Project Area and identified two Areas of Potential Environmental Concern (APECs) – freeway right-of-ways (ROW) and a former diesel spill and fire remediated area under the Rainbow Valley Bridges (RVB). In 2021, following the recommendations of the Phase I ESA, Associated completed a Phase II ESA² to assess shallow soil quality along WMD and identify contaminants of concern (COCs) that may be encountered during project earthworks and construction. The Phase II ESA confirmed salt impacts in soil from ground surface to the maximum depth of the salinity investigation of 1.0 meters below ground surface (mbgs). Contaminants of concern include chloride and sodium elevating soil electrical conductivity (EC) and sodium adsorption ratio (SAR) values to exceed environmental guidelines. Soils underlying the entire Project Area are considered to be impacted by historical road salt applications. The total vertical extents of the salt impacts are unknown, but for the purposes of earthworks and construction, all soils from all depths should be considered as salt-impacted.

The information contained in this CSMS reflects Associated's knowledge of the Project Area conditions to date and is based on the results of the Phase II ESA. The CSMS will provide a guide for contaminated soil and water management during the construction phase of the Project. This document is a guideline document only and does not replace a Contamination Management Plan (CMP); typically required and prepared by the contractor prior to construction activities. As new information becomes available, including but not limited to other reports (e.g. geotechnical) and engineering designs for the Project Area, an environmental consultant must update this CSMS for use by the contractor prior to construction tender and subsequent development of an Environmental Construction Operations (ECO) Plan.

¹ Associated Engineering. 2020. Limited Phase I Environmental Site Assessment – Rainbow Valley Bridges Renewal & Widening / Terwillegar Drive Stage 2 Upgrades. 2019-3585.

² Associated Engineering. July 2021. Draft. Phase II Environmental Site Assessment – Terwillegar Drive Stage 2. 2021-3981.

Memo To: Reg Ball, CIMA+
November 18, 2021
Page 2

2 SCOPE

The CSMS development involved the following tasks:

- Review available background information, including the Rainbow Valley Bridges, B162 (WB) & B180 (EB) Whitemud Drive over Whitemud Creek Rehabilitation & Widening Recommendations engineering design³ and the Phase II Environmental Site Assessment –Terwillegar Drive Stage 2 conducted for the Project²;
- Prepare a CSMS that provides recommended soil and water management practices during construction to be used as part of tendering and for use by the selected contractor(s) to guide the development of an ECO Plan.

3 REGULATORY FRAMEWORK

Soil and groundwater contamination in Alberta are addressed under the Environmental Protection and Enhancement Act (EPEA) (RSA 2000, c. E-12). All laboratory analytical data evaluated in support of this CSMS was evaluated based upon the requirements of the *Alberta Environmental Site Assessment Standard* (Alberta Environment and Parks [AEP])⁴, *Contaminated Sites Policy Framework* (Alberta Environment and Sustainable Resource Development [AESRD])⁵, *Environmental Quality Guidelines for Alberta Surface Waters*⁶, and *Alberta Tier 1 Soil and Groundwater Remediation Guidelines* (AT1 Guidelines)⁷.

The Project Area is considered commercial land use and consists of paved roads, bridges, and associated ROWs bordering residential/parkland areas. Particle size analysis determined that the soils are primarily fine-grained. Soil analytical results from the Phase II ESA were compared to applicable 2019 AT1 Guidelines for fine-grained soils and commercial land use at areas along WMD. Residential/parkland land use guidelines were applied to areas within Rainbow Valley Park and in proximity to Whitemud Creek.

³ Associated Engineering. 2020. Rainbow Valley Bridges, B162 (WB) & B180 (EB) Whitemud Drive over Whitemud Creek Rehabilitation & Widening Recommendations. 2019-3585.

⁴ Alberta Environment and Parks (AEP). 2016. Alberta Environmental Site Assessment Standard. Available online at: <https://open.alberta.ca/dataset/3acc7cff-8c50-44e8-8a33-f4b710d9859a/resource/579321b7-5b66-4022-9796-31b1ad094635/download/environmentsiteassessstandard-mar01-2016.pdf>.

⁵ Alberta Environment and Sustainable Resource Development (AESRD). 2014. Contaminated Sites Policy Framework. Available online at: <https://open.alberta.ca/dataset/69e71d6a-fd06-4c4c-bbe3-2ed0baac0d23/resource/9dbb9ef9-649e-4d0f-a806-1d8495008e13/download/zz-2014-contaminated-sites-policy-framework-2014-10-31.pdf>.

⁶ Alberta Environment and Parks (AEP). 2018. Environmental Quality Guidelines for Alberta Surface Waters. Available online at: <https://open.alberta.ca/dataset/5298aadb-f5cc-4160-8620-ad139bb985d8/resource/38ed9bb1-233f-4e28-b344-808670b20dae/download/environmentalqualitysurfacewaters-mar28-2018.pdf>.

⁷ Alberta Environment and Parks (AEP). 2019. Alberta Tier 1 Soil and Groundwater Remediation Guidelines. Available online at: <https://open.alberta.ca/dataset/842becf6-dc0c-4cc7-8b29-e3f383133ddc/resource/a5cd84a6-5675-4e5b-94b8-0a36887c588b/download/albertatier1guidelines-jan10-2019.pdf>

Memo To: Reg Ball, CIMA+
November 18, 2021
Page 3

4 PROJECT WORKS

The following reports for the project were used to evaluate the extent of the work areas identified in Figure 1:

- Limited Phase I Environmental Site Assessment – Rainbow Valley Bridges Renewal & Widening / Terwillegar Drive Stage 2 Upgrades. 2019-3585¹;
- Rainbow Valley Bridges, B162 (WB) & B180 (EB) Whitemud Drive over Whitemud Creek Rehabilitation & Widening Recommendations. 2019-3585³; and
- Rainbow Valley Bridges Renewal & Widening Terwillegar Drive Stage 2 Upgrades – Environmental Overview. 2019-3585⁸.

The development of this CSMS is based on the following assumptions:

- The references listed above were used to estimate the proposed work area footprint.;
- The average depth to groundwater is expected to be approximately 4-5 mbgs^{9,10}; however, groundwater may be shallower at some parts of the ROW based on nearby estimated surface water elevation;
- Soil containing EC and SAR at levels exceeding the applicable AT1 guidelines are present between ground surface to a depth of at least 1.0 mbgs along the entirety of the Project Area, as identified in the Phase II ESA² and summarized in Tables 1 to 3 (attached); and
- If excavation depths exceed 1.0 mbgs, an environmental professional will assess soil quality and provide recommendations for soil management to the contractor(s).

Stage 2 Upgrade construction works are anticipated to include upgrading the WMD-Terwillegar Drive interchange, widening WMD between Fox Drive and 122 Street, rehabilitating and widening of the RVB, and adding a bus-only lane between 53 Avenue and Terwillegar Drive. The maximum excavation depths are currently expected to be approximately 1.0 metres along most of the alignment but may be deeper in select locations.

Based on the locations of previously identified EC and SAR impacted soil, correlated with the footprint of the proposed construction and associated infrastructure, salt-contaminated soil will be encountered during construction. Although groundwater is estimated to be deeper than 4.0 mbgs, groundwater may be encountered during construction activities due to seasonal and localized groundwater level variations.

⁸ Associated Engineering. 2020. Rainbow Valley Bridges Renewal & Widening Terwillegar Drive Stage 2 Upgrades – Environmental Overview. 2019-3585.

⁹ Thurber Engineering Ltd. 2021. Terwillegar Drive Stage 2, Rainbow Valley Bridge Widening, Edmonton, Alberta – Geotechnical Investigation and Geotechnical Assessment of Bridge Foundations.

¹⁰ Thurber Engineering Ltd. 2009. Fox Drive Road Widening/Rehabilitation, Campbell Bridge to 200 M West of Belgravia Road – Geotechnical Investigation.

Memo To: Reg Ball, CIMA+
November 18, 2021
Page 4

5 CONTAMINATION SUMMARY

The Phase II ESA² consisted of advancing 30 hand auger test holes at select locations along WMD and under RVB. Test holes were evenly distributed throughout the Project Area to provide a general understanding of on-site soil conditions that will be encountered during construction. With the exception of test holes beneath RVB, test holes were completed within 3 m of nearby roadways where it was safe to access and clear of underground facilities.

Salinity (EC and SAR) exceedances were identified at all 27 sampling locations along WMD and under the RVB. There was also one pH exceedance. The following summarizes the Phase II ESA analytical results:

- Electrical conductivity values ranged between 1.6 and 100 dS/m;
- Sodium adsorption ratios ranged between 6.5 and 60;
- All 27 test holes analyzed for salinity exceeded the commercial land use AT1 Salt Remediation Guidelines for EC and/or SAR. For commercial land use, there are only single guideline values for both EC and SAR (4 dS/m and 12, respectively);
- For samples collected beneath the bridges that were analyzed for salinity, EC values ranged from good to unsuitable. All SAR values were rated as unsuitable;
- Chloride values throughout the project area ranged from 140 mg/kg to 20,000 mg/kg;
- Sodium concentrations ranged from 160 mg/kg to 10,000 mg/kg;
- One sample had basic pH (9.39) exceeding AT1 Guidelines (6-8.5); and
- All other analyzed parameters were less than the AT1 Guidelines.

These reported values and concentrations may not be representative of the maximum salinity impacted soils which may be encountered throughout the Project Area due to the spacing between sample locations. Soil EC and SAR values are influenced by salt ions including chloride, sodium, sulphate, and to lower extent calcium, magnesium, and potassium. Chloride and sodium are main components of common road salt compounds (specifically sodium chloride) and are key indicators of anthropogenic activity. Sodium and chloride are contaminants of concern. The one basic pH soil value encountered is considered an anomalous result and not a concern for roadway and construction purposes.

Figure 1 shows the sampling locations and parameter exceedances. Soil analytical results compared to the applicable guidelines are provided in Tables 1 to 3. Groundwater was not assessed during the Phase II ESA. Should groundwater be encountered, management procedures will be implemented by the contractor.

6 CONTAMINATION MANAGEMENT

The contractor must perform soil management throughout the entire Project Area as per this CSMS. It is the contractor's responsibility to retain a qualified environmental professional as needed during construction for this Project. This section outlines required practices for excavation, stockpiling, re-use and disposal of soils for the Project supported by field observations and laboratory results from the previous field investigation².

Memo To: Reg Ball, CIMA+
November 18, 2021
Page 5

6.1 Soil Handling Procedures

6.1.1 Excavation Procedures

Soils should only be excavated to the extent required to complete the Project work. The following controls apply during excavation:

- Access to the excavation area(s) will be restricted to authorized personnel;
- The presence of EC and SAR in soil was reported by Associated² to exceed the 2019 AT1 Guidelines 'Commercial' rating at all locations along Whitemud Drive from ground surface to 1.0 mbgs. Within the context of the current excavation program, these soils are suitable for re-use only within the areas where excavation has occurred unless concerns indicative of other contaminants (visual and olfactory) are identified. Excavated soils can only be backfilled where they were originally excavated and cannot be moved and backfilled in a different location;
- Topsoil (dark brown organics) and subsoil will remain separate and be stripped in a way that minimizes the risk of admixing;
- Should stockpiling be required, soils must be segregated as such:
 - Topsoil (dark brown organic) and subsoils will remain separated;
 - All stripped and excavated soils will be segregated from non-salinity impacted soils (i.e. import fill); and
 - If soil is not re-used within the original location that it was excavated, it is to be managed as outlined in Section 6.1.3;
- Soil EC and SAR concentrations reported underneath Rainbow Valley Bridges significantly exceed the AT1 Guidelines 'Unsuitable' rating for Residential/Parkland land use and are considered heavily salt-impacted. These soils are not to be re-used anywhere in the Project Area and must be disposed of as outlined in Section 6.1.3;
- Soils excavated from depths greater than 1.0 mbgs are assumed to be salt-impacted and will need to be collected, stockpiled, and tested before re-use or disposal;
- Contaminated soils (or potentially contaminated soils) will be handled in a manner that will not result in the contamination of any other location including those with identified EC and SAR exceedances, as outlined in Section 6.1.2;
- Refer to Section 6.3 if suspected hydrocarbon contaminated soils are encountered (i.e., visibly stained and/or odorous materials);
- Appropriate Erosion and Sediment Control (ESC) will be implemented (where required); and
- Water management will be implemented as applicable. Refer to Section 6.2.

6.1.2 Stockpiling Procedures

Prior to excavation, the contractor will establish site-specific control measures and determine appropriate stockpile locations. Any stained and/or odorous soil encountered must be treated as contaminated and temporarily stockpiled. All potentially contaminated stockpiled material must be sampled by a qualified environmental professional for analyses at an accredited laboratory to determine if it meets applicable AT1 Guidelines for re-use within the Project Area. If the soil

Memo To: Reg Ball, CIMA+
November 18, 2021
Page 6

does not meet AT1 Guidelines for contaminants other than salinity, it must be disposed of at a provincially regulated Class II Landfill facility.

For excavations deeper than 1.0 mbgs, soils must be stockpiled by the contractor and sampled by a qualified environmental professional. Sampling frequency shall be a minimum of one sample per 100 m³ of soil. Parameters to be analyzed should include at a minimum detailed salinity. Samples will be submitted for laboratory analyses at an accredited laboratory, as per Section 6.1.3, for comparison to applicable AT1 Guidelines. Using the qualified environmental professional's judgement, if the material does not meet the AT1 Guidelines, with the exception of EC and SAR, the soil must be disposed of at a licensed Class II Waste Management Facility.

At a minimum, the contractor will maintain the following stockpile controls when stockpiling soils with possible contamination:

- Stockpiles must be stored in accordance with all applicable provincial, municipal and/or Project-specific requirements; including ESC and/or dust management;
- Contaminated material, and material suspected of containing contamination, will be stockpiled and managed on-site in a manner that does not cause contamination in any other areas;
- Suspected contaminated soils will be stockpiled and tested to ascertain the appropriate disposal facility;
- Any identified stained and odorous soil (hydrocarbon-impacted) must be treated as suspect contaminated;
- Stockpiles will be placed on areas cleared of vegetation;
- Stockpiles will be covered, as necessary, to prevent dust and odour emissions and rainfall/snow/ice contact;
- Stockpiles of soils suspected of hydrocarbon contamination will be kept on impermeable plastic sheeting (liner);
- Heavy equipment operation on the liner must be conducted in such a way as to maintain the integrity of the liner;
- The liner will be installed over berms designed and maintained to contain soils and potential run-off within the soil storage area; and
- Any soils confirmed as being contaminated will not be subject to long-term storage and shall be sent for disposal at an appropriate Class II Waste Management Facility as soon as reasonably possible.

6.1.3 Soil Re-use or Disposal Procedures

Soils will be re-used on-site along WMD where possible including soils with elevated EC and SAR values. Soils should be re-used at their original excavated location to prevent the spread of soils with elevated EC and SAR values to areas with potentially lower EC and SAR values. Soils should be backfilled in the order they were excavated so that backfilling of potentially higher impacted soils from near ground surface are not placed at lower potentially less-impacted or non-impacted depths.

If excavated soils cannot be re-used at their current location the following applies:

- Soils may be re-used within the Project Area, with the exception of within 100 m of Whitemud Creek, as long as EC and SAR values are lower than the values of the location they are being hauled and deposited as to prevent

Memo To: Reg Ball, CIMA+
November 18, 2021
Page 7

spreading of higher salt-impacted soils. The sampling frequency of soils being moved to another location within the Project Area is a minimum of one sample per 100 m³.

Soils excavated within 100 m of Whitemud Creek (Figure 1) cannot be re-used and must be disposed of at an approved Class II Waste Management Facility.

Excess soils that are not to be used within the Project Area must be disposed of at an approved Class II Waste Management Facility.

Stockpiled soils that cannot be used within the Project Area or that are suspected of being contaminated must be sampled by a qualified environmental professional and analyzed at a Canadian Association for Laboratory Accreditation (CALA) accredited laboratory for petroleum hydrocarbons, metals, detailed salinity, and any other additional parameters at the discretion of the environmental professional. The environmental professional shall provide recommendation(s) to the contractor for soil re-use, management and/or disposal to an approved Class II Waste Management facility based on the laboratory results.

Any sampling/analysis required to either characterize the stockpiled soil, or meet the requirements of the receiving facility, is the responsibility of the Contractor.

6.1.4 Import Fill/Soils

The contractor will ensure that any imported fill/soil brought from off-site is weed free and meets applicable Alberta Tier 1 Guidelines for the applicable land uses prior to material being brought to site. A qualified environmental professional must collect representative samples and review the analytical data. Minimum import fill characterization parameters will include detailed salinity, metals, BTEX (benzene, toluene, ethylbenzene, xylenes), petroleum hydrocarbons (PHC) fractions F1-F4, and polycyclic aromatic hydrocarbons (PAH). A minimum of one representative composite sample for every 500 m³ of import fill/soil must be tested.

Every load of soil coming onto the Project Area must be inspected in accordance with the visual inspection plan that shall be provided in the ECO Plan. The plan shall contain provisions for visually inspecting every load of soil brought onto the Project Area to identify soil staining, visual and olfactory evidence of hydrocarbons, evidence of landfill debris and to provide that if such evidence is present the soil will be segregated and will not be placed on the Project Area (except on an impervious surface) until additional testing has been completed to verify that the soil meets environmental requirements. The visual inspection plan shall require that there is a written record of the visual inspection conducted on every load of soil to be deposited in the Project Area that originated from off-site.

Memo To: Reg Ball, CIMA+
November 18, 2021
Page 8

6.2 Surface and Groundwater Procedure

Based on the Project Area conditions and construction details presently available, groundwater is not anticipated to be encountered during construction activities. Potentially isolated water seepage from the subsoil and surface water may enter excavations (due to significant precipitation events) and require management.

A water management plan must be supplied by the Contractor and should indicate the types of contamination to be tested for, possible pump-off locations, disposal options, and measures to prevent nearby infrastructure from being damaged by pump-off water. Pump-offs should be completed onto vegetated areas, whenever possible, and should not discharge into a surface water body or wetland. Pump-offs should be conducted in a manner to allow for soil infiltration and minimize the creation of any ponding, pooling, or erosion in the disposal area.

Final disposal (or discharge) options will be based upon the water quality of the collected samples compared to the applicable regulatory guidelines, as well as the City of Edmonton municipal storm (or sanitary if applicable) sewer system discharge requirements (i.e., City of Edmonton Bylaw 18100, as amended). The City and EPCOR must provide approval prior to the discharge of any water.

Any required laboratory analyses, as well as the final disposal of any water removed from the excavation, remains the responsibility of the contractor. Additionally, the contractor will implement measures to prevent the infrastructure from being damaged by the contamination and to prevent migration of contamination due to the Project work and infrastructure.

6.3 Contamination Discovery Procedure

During excavation, the contractor may intersect zones of previously unidentified contamination or suspect contamination (based on visual and olfactory observations). Given that actual COC parameter concentrations cannot be determined in the field, suspected contaminated soil is subject to the soil stockpiling procedures identified in Section 6.1.2. Re-use or disposal decisions will be made only after laboratory analysis results are received and reviewed by a qualified environmental professional.

Characterization sampling must be undertaken by a qualified environmental professional with sufficient experience in soil sampling. Sampling will consist of at least five discrete soil samples per 50 m³ from individual and representative portions of the stockpile. Discrete sampling soil stockpiles are to be carried out as per the requirements of the City of Edmonton.

Upon the discovery of suspected contaminated soils (visibly stained and odorous materials) refer to Table 6-1 below.

Memo To: Reg Ball, CIMA+
 November 18, 2021
 Page 9

Table 6-1
 Contamination Discovery Steps

Step	Procedure
1 – Stop Work	<ul style="list-style-type: none"> Secure the area. Review procedure for handling soil with suspected contamination (i.e., stockpiling procedures). Ensure response measures to reduce exposure to site personnel and dispersion are properly installed (e.g., check dams, silt fences, water diversions).
2 – Notify	<ul style="list-style-type: none"> Site Supervisor. Engineer Project Manager. City of Edmonton Project Manager.
3 – Resume Work	<ul style="list-style-type: none"> Conduct meeting(s) to address any changes to worksite conditions or activities and to manage any remaining contamination. Resume work, ensuring that soil with suspected contamination is segregated into a separate stockpile.
4 – Assessment	<ul style="list-style-type: none"> Retain a qualified environmental professional to test suspected contaminated soils/water as required. Determine whether soil/water needs to be disposed of at a waste management facility or is available for re-use.
5 – Contractors	<ul style="list-style-type: none"> Follow the direction of the City of Edmonton Project Manager and qualified professional to resolve contamination discovery (i.e., determine the outcome of stockpiled material). Track time, expenses, and materials related to contamination discovery.
6 – Follow-Up	<ul style="list-style-type: none"> Revise the ECO Plan, and provide for review.

6.4 Tracking and Record-Keeping

The Contractor should follow proper documentation tracking of excavated contaminated soil to demonstrate that appropriate transport and disposal procedures are followed. For waste quality soils leaving the Project Area, a soil tracking and record-keeping system should be developed and implemented by the Contractor to document the source location of all excavated waste quality soils and/or debris that leave the Project Area each day, including the date of excavation, estimated tonnage, date of hauling, and name of receiving facility. Copies of shipping documents and receipts of delivery should be kept as part of tracking and record-keeping and submitted to the City.

Should any excess soil exceeding the Alberta Tier 1 guidelines and considered contaminated by the environmental profession be identified at the Project Area, it will require laboratory testing prior to disposal. If the laboratory tests determine that the material can be disposed of at a Class II non-hazardous landfill or if it must be disposed of at a hazardous waste landfill, a waste generator number and associated documentation will need to be issued by the landfill to the City and the Contractor. This is the process that is outlined in the Waste Regulation under Environmental

Memo To: Reg Ball, CIMA+
November 18, 2021
Page 10

Protection and Enhancement Act. This regulated documentation may include manifests and should be used in tandem with the associated soil tracking listed above.

A manifest for each truckload of waste soil will need to be completed by the Contractor, with one copy of the manifest kept at the Project Area and two copies provided to the truck driver (transporter). Upon delivery of the soil to the receiving facility, the truck driver will provide the two manifest copies to the disposal facility operator. The facility operator will record the scaled weight and keep one copy of the manifest on file and forward the second copy of the manifest to the Contractor. Once all of the soil has been removed and disposed of at the appropriate facility, the Contractor will need to reconcile the manifests and provide copies to the City, as per the Waste Regulation. Record retention should follow the Waste Regulation.

Any soils that cannot be re-used at their original excavation location and are acceptable by the environmental professional for re-use elsewhere along WMD, must be documented where they originated from, date moved, and final backfill location and depth.



7 CLOSURE

This CSMS memo was prepared for CIMA+ to support project earthworks and construction along Whitemud Drive between Fox Drive and 122 Street. Contaminated soil, and possibly water may be encountered during construction. Management of these media may affect the Project schedule and budget if their presence is unanticipated. As a result, these soils management and contamination discovery procedures have been developed for use and/or to guide preparation of ECO Plan development during construction activities.

The services provided by Associated Engineering Alberta Ltd. in the preparation of this report were conducted in a manner consistent with the level of skill ordinarily exercised by members of the profession currently practicing under similar conditions. No other warranty expressed or implied is made.

Respectfully submitted,
Associated Engineering Alberta Ltd.

Prepared by:

Reviewed by:

Richard Henschel, ATT
Environmental Scientist



Brent Schmidt, P. Geo
Geoscientist

November 18, 2021
ID# 102556

- Attachment 1: Figure 1
- Attachment 2: Soil Analytical Results Summary Tables 1, 2, and 3

ASSOCIATED ENGINEERING ALBERTA LTD.

STANDARD DISCLAIMER FOR CONTAMINATED SITE INVESTIGATIONS, MONITORING AND CONFIRMATION OF REMEDATION SERVICES

Subject to the following conditions and limitations, the investigation described in this report has been conducted by Associated Engineering Alberta Ltd. (Associated) for CIMA+ (the Client) in a manner consistent with a reasonable level of care and skill normally exercised by members of the environmental science profession currently practicing under similar conditions in the area.

1. The scope of the investigation described in this report has been limited by the budget set for the investigation in the work program. The scope of the investigation has been reasonable having regard to that budget constraint.
2. The investigation described in this report has been limited to the scope of work described in the work program.
3. The investigation described in this report has relied upon information provided by third parties concerning the history of the site. Except as stated in this report, we have not made an independent verification of such historical information.
4. The investigation described in this report has been made in the context of existing government regulations generally promulgated at the date of this report. Except as specifically noted, the investigation did not take account of any government regulations not in effect and generally promulgated at the date of this report.
5. All documents and drawings prepared by Associated, or by others on behalf of Associated, in connection with this Project are instruments of professional service for the execution of the Project. Associated retains the property and copyright in these documents and drawings, whether the Project is executed or not.
6. The findings and conclusions are valid only for the specific site identified in the report.
7. Since site conditions may change over time, the report is intended for immediate use.
8. This report is intended for the exclusive use of the Client, including all successors and assigns. The material in it reflects Associated's best judgement, in light of the information available to it, at the time of preparation. Any use that a third party makes of this report, or any reliance on or decisions to be made based on it, are the responsibility of such third parties. Associated accepts no responsibility for damages, if any, suffered by any third party as a result of decisions made or actions based on this report and makes no representation of fact or opinion of any nature whatsoever to any person or entity other than the Client.

In accepting delivery of this report, the Client hereby agrees that:

- A. Associated's liability for all claims of the Client, arising out of the agreement between Associated and the Client, pursuant to which this report has been prepared (the Agreement) shall absolutely cease to exist after a period of six (6) years from the date of:
 - i. substantial completion of the investigation described in this report,
 - ii. termination of Associated's Services under the Agreement,
 - iii. commencement of the limitation period for claims prescribed by any statute of the Province or Territory for the site of the investigation described in this report,
 - iv. any significant alteration of the site of the investigation described in this report, and/or neighbouring properties after the date of the final report that would change the conclusions and recommendations of the final report, whichever shall first occur, and following the expiration of such period, the Client shall have no claim whatsoever against Associated.
- B. Any and all claims that it may have against Associated's or any of its servants, agents, or employees arising out of or in any way connected with the investigation described in this report or the preparation of this report, whether such claims are in contract or in tort, and whether such claims are based on negligence or otherwise, shall be limited to a total amount equal to the fees payable to Associated's under the contract with the Client. Associated's shall bear no liability whatsoever for any consequential loss, injury or damage incurred by the Client including but not limited to claims for loss of profits and loss of markets.

FIGURE

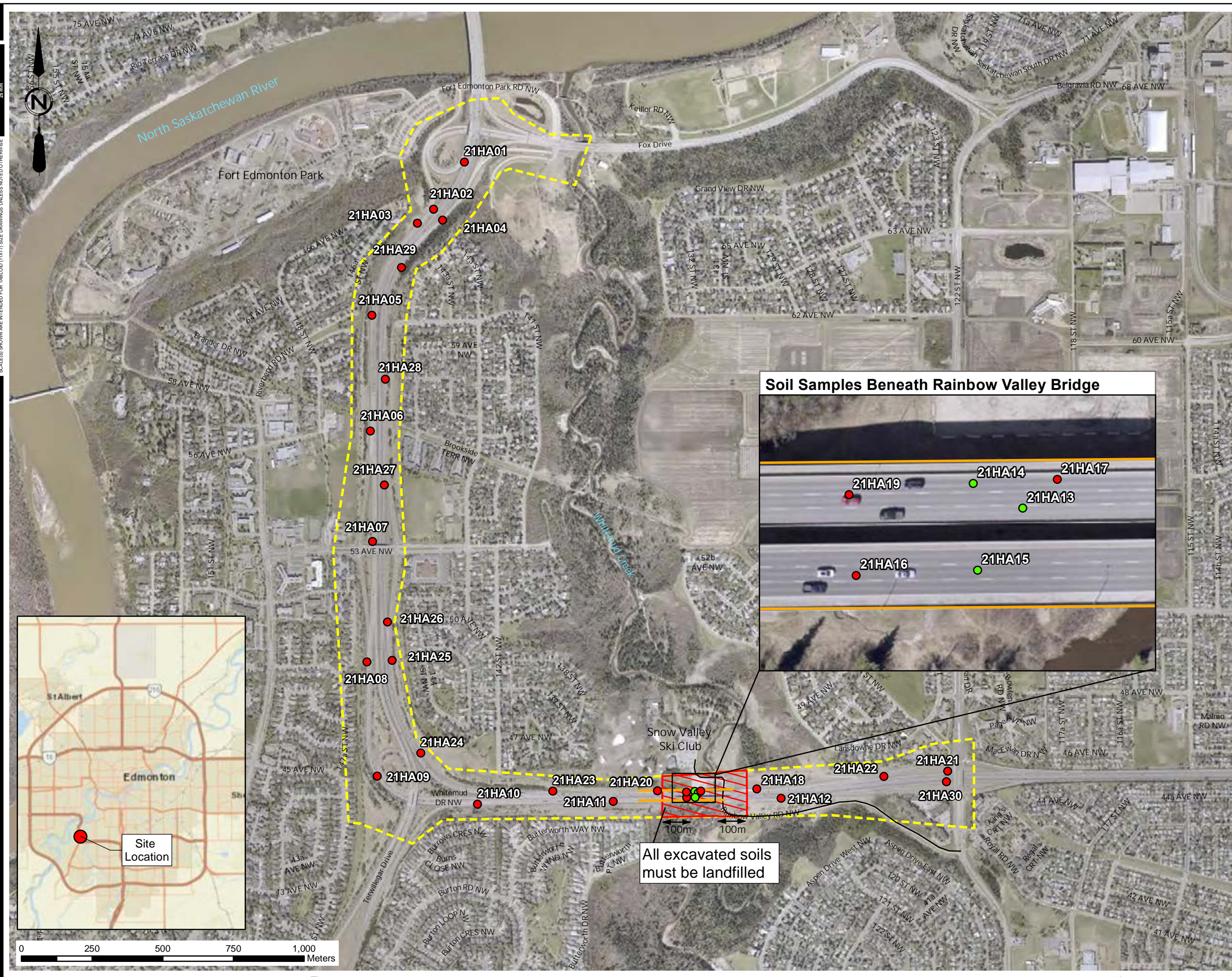

Legend

- Soil Sample Meets Regulatory Guidelines (PFAS only)
- Soil Sample Exceeds Regulatory Guidelines for EC and/or SAR
- Rainbow Valley Bridges
- Rainbow Valley Road
- Project Area

Notes:

All samples that were tested for BTEX, PHC fractions F1-F4, Metals and PAH met regulatory guidelines

pH exceedance only at 21HA28 (0.6-0.8m)

EC - electrical conductivity
SAR - sodium absorption ratio



FIGURE 1

TERWILLEGAR DRIVE STAGE 2 UPGRADES AND RAINBOW VALLEY BRIDGE RENEWAL AND WIDENING - CONTAMINATED SOIL MANAGEMENT STRATEGY

PROJECT AREA AND SOIL SUMMARY

AE PROJECT NO.	2021-3981
SCALE	1:13,000
APPROVED DATE	2021 JUL 28
REV DESCRIPTION	ISSUED FOR MEMO



TECHNICAL MEMORANDUM

TABLES

Table 1a. Soil Analytical Results - Salinity, Physical Parameters, and Metals - Commercial Guidelines
Project: 2021-3981

Sample Location		21HA01	21HA02	21HA03	21HA05	21HA06		21HA07		
Depth (m)		0.6-1.0	0.6-1.0	0.6-1.0	0.6-1.0	0.0-0.3	0.6-1.0	0.0-0.3		
Duplicates		-	-	-	-	-	-	-		
Date Sampled		2-Jun-21	3-Jun-21	3-Jun-21	3-Jun-21	3-Jun-21	3-Jun-21	3-Jun-21		
Lab ID		ZY0020	ZY0022	ZY0024	ZY0028	ZY0044	ZY0045	ZY0046		
Parameter	Units	AT1 Commercial Fine	Whitemud Drive Southbound Fox Drive to 53 Ave NW							
Salinity & Physical Parameters	pH (1:2 CaCl2)	pH units	6-8.5	7.61	7.65	7.70	7.93	7.72	7.66	7.86
	Conductivity (Sat. Paste)	dS/m	4	11	9.9	6.8	11	2.8	13	4.3
	Sodium Adsorption Ratio (SAR)	-	12	6.5	9.4	12	30	30	21	35
	Chloride	mg/kg	-	2000	1200	1500	1800	540	1700	420
	Calcium	mg/kg	-	770	430	230	160	22	440	15
	Magnesium	mg/kg	-	170	83	43	21	2.5	39	1.4
	Potassium	mg/kg	-	15	11	3.9	11	7.3	11	4.6
	Sodium	mg/kg	-	630	560	630	1100	400	1300	330
	Sulphate	mg/kg	-	1000	940	88	390	39	1600	75
	Saturation	%	-	68	47	70	57	52	59	37
	Moisture	%	-	24	12	24	20	16	20	4.3
	Soil Texture	NA	-	-	FINE	-	-	-	-	-
	Sieve - #200 (>0.075mm)	%	-	-	28	-	-	-	-	-
Metals	Antimony	mg/kg	40	<0.50	<0.50	<0.50	<0.50	<0.50	<0.50	<0.50
	Arsenic	mg/kg	26	10	7.4	8.1	7.0	6.0	9.4	5.2
	Barium	mg/kg	2000	220	180	220	180	180	200	130
	Beryllium	mg/kg	8	0.82	0.52	0.89	0.54	0.62	0.56	0.40
	Boron	mg/L	5.0	<0.10	<0.10	<0.10	<0.10	0.11	<0.10	0.16
	Cadmium	mg/kg	22	0.34	0.22	0.23	0.24	0.24	0.30	0.23
	Chromium	mg/kg	87	25	28	30	34	32	20	35
	Chromium (hexavalent)	mg/kg	1.4	<0.080	<0.080	<0.080	<0.080	<0.080	<0.080	<0.080
	Cobalt	mg/kg	300	12	9.1	12	8.6	11	9.3	7.6
	Copper	mg/kg	91	31	17	26	19	19	23	16
	Lead	mg/kg	260	13	9.8	14	12	19	11	22
	Mercury	mg/kg	24	0.057	<0.050	0.050	<0.050	<0.050	0.050	<0.050
	Molybdenum	mg/kg	40	1.3	1.1	1.0	1.2	1.1	1.1	1.2
	Nickel	mg/kg	89	34	28	34	31	29	26	27
	Selenium	mg/kg	2.9	<0.50	0.59	<0.50	<0.50	<0.50	0.73	<0.50
	Silver	mg/kg	40	<0.20	<0.20	<0.20	<0.20	<0.20	<0.20	<0.20
	Thallium	mg/kg	1	0.25	0.17	0.21	0.18	0.14	0.22	0.12
	Tin	mg/kg	300	<1.0	<1.0	<1.0	<1.0	1.0	<1.0	<1.0
	Uranium	mg/kg	33	1.1	1.0	0.99	0.99	0.65	1.0	0.55
Vanadium	mg/kg	130	35	28	42	28	35	29	26	
Zinc	mg/kg	410	91	62	77	64	86	79	68	

Notes:

AT1 - Alberta Environment and Parks (AEP). 2019. Alberta Tier 1 Soil and Groundwater Remediation Guidelines. Land Policy Branch, Policy and Planning Division. 198 pp (Commercial land use and Fine-grained surface soil criteria)

Shading indicates result exceeds AT1 Guidelines for Commercial Land Use

- Not analyzed/No Guideline



Table 1a. Soil Analytical Results - Salinity, Physical Parameters, and Metals - Commercial Guidelines
Project: 2021-3981

Sample Location		21HA08	21HA09			21HA10		21HA11	21HA12		21HA30	
Depth (m)		0.6-1.0	0.0-0.3			0.0-0.3	0.6-1.0	0.6-1.0	0.0-0.3	0.6-1.0	0.0-0.3	
Duplicates		-	-	DUP3		-	-	-	-	-	-	
Date Sampled		3-Jun-21	3-Jun-21	3-Jun-21	3-Jun-21	3-Jun-21	3-Jun-21	3-Jun-21	3-Jun-21	3-Jun-21	2-Jun-21	
Lab ID		ZY0049	ZY0050	ZY0096	ZY0052	ZY0053	ZY0055	ZY0056	ZY0057	ZY0092		
Parameter	Units	AT1 Commercial Fine	Whitemud Drive Southbound 53 Ave NW to Terwillager Drive Overpass			Whitemud Drive Eastbound Terwillager Drive to Rainbow Valley Bridge			Whitemud Drive Eastbound Rainbow Valley Bridge to 122 St NW			
			Salinity & Physical Parameters	pH (1:2 CaCl2)	pH units	6-8.5	8.11	7.78	7.62	8.15	8.17	7.71
Conductivity (Sat. Paste)	dS/m	4		8.4	2.7	2.2	6.3	4.8	11	14	9.5	2.5
Sodium Adsorption Ratio (SAR)	-	12		37	27	23	50	30	14	64	50	22
Chloride	mg/kg	-		1800	230	180	690	980	1800	2400	1200	330
Calcium	mg/kg	-		63	12	8.7	16	37	460	73	43	21
Magnesium	mg/kg	-		15	1.4	1.1	1.8	6.7	130	7.5	4.6	5.2
Potassium	mg/kg	-		5.5	3.9	3.0	5.0	4.2	22	13	6.8	10
Sodium	mg/kg	-		1000	220	160	490	620	1100	1600	850	330
Sulphate	mg/kg	-		77	37	20	36	130	1500	57	93	57
Saturation	%	-		65	38	36	38	70	67	54	43	60
Moisture	%	-		27	20	19	9.9	25	21	15	18	23
Soil Texture	NA	-		-	-	-	-	-	FINE	-	COARSE	-
Sieve - #200 (>0.075mm)	%	-		-	-	-	-	-	7.1	-	56	-
Metals	Antimony	mg/kg		40	<0.50	<0.50	0.52	<0.50	<0.50	0.52	<0.50	<0.50
	Arsenic	mg/kg	26	12	5.9	4.0	5.1	7.6	5.8	5.8	5.8	6.1
	Barium	mg/kg	2000	210	180	110	140	210	280	140	180	150
	Beryllium	mg/kg	8	0.64	0.60	<0.40	0.48	0.69	0.77	0.51	0.40	0.58
	Boron	mg/L	5.0	<0.10	0.12	0.10	0.15	<0.10	<0.10	0.19	0.10	0.20
	Cadmium	mg/kg	22	0.41	0.25	0.18	0.18	0.25	0.32	0.26	0.22	0.30
	Chromium	mg/kg	87	22	44	32	38	28	23	42	17	38
	Chromium (hexavalent)	mg/kg	1.4	<0.080	<0.080	<0.080	<0.080	<0.080	<0.080	<0.080	<0.080	<0.080
	Cobalt	mg/kg	300	12	9.4	5.6	7.3	11	12	7.7	7.6	8.4
	Copper	mg/kg	91	29	20	17	16	23	35	22	13	22
	Lead	mg/kg	260	14	15	18	15	12	12	31	7.4	17
	Mercury	mg/kg	24	0.094	<0.050	<0.050	<0.050	<0.050	0.051	<0.050	<0.050	<0.050
	Molybdenum	mg/kg	40	1.3	1.3	1.3	1.3	1.2	1.0	1.6	0.78	1.2
	Nickel	mg/kg	89	33	34	21	28	32	34	29	20	30
	Selenium	mg/kg	2.9	2.9	<0.50	<0.50	<0.50	<0.50	<0.50	<0.50	<0.50	0.59
	Silver	mg/kg	40	<0.20	<0.20	<0.20	<0.20	<0.20	<0.20	<0.20	<0.20	<0.20
	Thallium	mg/kg	1	0.24	0.16	<0.10	0.15	0.21	0.28	0.13	0.20	0.14
	Tin	mg/kg	300	<1.0	<1.0	<1.0	<1.0	<1.0	<1.0	1.1	<1.0	<1.0
	Uranium	mg/kg	33	1.1	0.74	0.51	0.63	1.0	1.9	1.1	0.92	1.4
Vanadium	mg/kg	130	35	34	19	28	39	26	29	20	31	
Zinc	mg/kg	410	98	92	81	67	73	74	82	47	82	

Notes:

AT1 - Alberta Environment and Parks (AEP). 2019. Alberta Tier 1 Soil and Groundwater Remediation Guidelines. Land Policy Branch, Policy and Planning Division. 198 pp (Commercial land use and Fine-grained surface soil criteria)

Shading indicates result exceeds AT1 Guidelines for Commercial Land Use

- Not analyzed/No Guideline



Table 1a. Soil Analytical Results - Salinity, Physical Parameters, and Metals - Commercial Guidelines
Project: 2021-3981

Sample Location		21HA21	21HA22	21HA18	21HA20	21HA23	21HA24				
Depth (m)		0.0-0.3	0.0-0.3	0.6-1.0	0.0-0.3	0.6-1.0	0.6-1.0				
Duplicates		-	DUP1	-	-	-	-				
Date Sampled		2-Jun-21	2-Jun-21	2-Jun-21	3-Jun-21	3-Jun-21	2-Jun-21	2-Jun-21			
Lab ID		ZY0074	ZY0094	ZY0076	ZY0069	ZY0072	ZY0079	ZY0081			
Parameter	Units	AT1 Commercial Fine	Whitemud Drive Westbound 122 St NW to Rainbow Valley Bridge				Whitemud Drive Westbound Rainbow Valley Bridge to Terwillegar Drive				
			Salinity & Physical Parameters	pH (1:2 CaCl2)	pH units	6-8.5	8.09	8.01	8.13	7.79	7.60
Conductivity (Sat. Paste)	dS/m	4		5.3	4.6	5.1	13	15	9.7	12	
Sodium Adsorption Ratio (SAR)	-	12		28	27	36	19	58	21	30	
Chloride	mg/kg	-		1100	820	780	3100	2700	750	2300	
Calcium	mg/kg	-		55	39	30	350	100	290	170	
Magnesium	mg/kg	-		9.6	6.3	4.1	120	16	27	33	
Potassium	mg/kg	-		7.7	6.0	5.5	13	9.5	11	7.7	
Sodium	mg/kg	-		690	550	580	1400	1800	1000	1300	
Sulphate	mg/kg	-		84	62	69	110	98	1800	98	
Saturation	%	-		67	63	53	71	57	54	61	
Moisture	%	-		18	21	21	19	23	23	22	
Soil Texture	NA	-		-	-	-	-	-	-	-	FINE
Sieve - #200 (>0.075mm)	%	-		-	-	-	-	-	-	-	30
Metals	Antimony	mg/kg		40	<0.50	<0.50	<0.50	<0.50	0.83	<0.50	<0.50
	Arsenic	mg/kg	26	8.5	6.4	6.3	9.5	5.2	7.9	8.3	
	Barium	mg/kg	2000	200	170	160	220	160	220	200	
	Beryllium	mg/kg	8	0.74	0.56	0.55	0.72	0.56	0.44	0.72	
	Boron	mg/L	5.0	0.12	0.14	0.17	<0.10	0.20	<0.10	<0.10	
	Cadmium	mg/kg	22	0.29	0.27	0.22	0.34	0.25	0.34	0.21	
	Chromium	mg/kg	87	35	29	26	26	44	19	76	
	Chromium (hexavalent)	mg/kg	1.4	<0.080	<0.080	<0.080	<0.080	<0.080	<0.080	<0.080	
	Cobalt	mg/kg	300	9.9	8.5	8.1	11	7.4	9.1	9.3	
	Copper	mg/kg	91	23	22	17	29	21	19	22	
	Lead	mg/kg	260	13	13	12	13	19	11	11	
	Mercury	mg/kg	24	<0.050	<0.050	<0.050	<0.050	<0.050	<0.050	0.061	
	Molybdenum	mg/kg	40	1.2	1.1	0.99	1.2	1.6	1.1	2.2	
	Nickel	mg/kg	89	32	27	25	35	29	25	50	
	Selenium	mg/kg	2.9	0.58	<0.50	<0.50	<0.50	0.51	0.55	<0.50	
	Silver	mg/kg	40	<0.20	<0.20	<0.20	<0.20	<0.20	<0.20	<0.20	
	Thallium	mg/kg	1	0.20	0.17	0.14	0.22	0.13	0.22	0.18	
	Tin	mg/kg	300	<1.0	<1.0	<1.0	<1.0	<1.0	<1.0	<1.0	
Uranium	mg/kg	33	2.0	1.9	1.7	1.2	1.8	1.2	0.96		
Vanadium	mg/kg	130	35	31	30	33	29	27	32		
Zinc	mg/kg	410	80	76	70	84	83	75	63		

Notes:

AT1 - Alberta Environment and Parks (AEP). 2019. Alberta Tier 1 Soil and Groundwater Remediation Guidelines. Land Policy Branch, Policy and Planning Division. 198 pp (Commercial land use and Fine-grained surface soil criteria)

Shading indicates result exceeds AT1 Guidelines for Commercial Land Use

- Not analyzed/No Guideline



Table 1a. Soil Analytical Results - Salinity, Physical Parameters, and Metals - Commercial Guidelines
Project: 2021-3981

Sample Location		21HA25	21HA26		21HA27		21HA28	21HA29	21HA04		
Depth (m)		0.6-1.0	0.6-1.0		0.0-0.3	0.6-1.0	0.6-0.8	0.6-1.0	0.0-0.3		
Duplicates		-	-	DUP2	-	-	-	-	-		
Date Sampled		2-Jun-21	2-Jun-21	2-Jun-21	2-Jun-21	2-Jun-21	2-Jun-21	2-Jun-21	2-Jun-21		
Lab ID		ZY0083	ZY0085	ZY0095	ZY0086	ZY0087	ZY0089	ZY0091	ZY0025		
Parameter	Units	AT1 Commercial Fine	Whitemud Drive Northbound Terwillegar Drive to 53 Ave NW			Whitemud Drive Northbound 53 Ave NW to Fox Drive					
			Salinity & Physical Parameters	pH (1:2 CaCl2)	pH units	6-8.5	7.66	7.52	7.53	8.24	7.97
Conductivity (Sat. Paste)	dS/m	4		12	14	15	4.5	7.4	11	2.1	1.6
Sodium Adsorption Ratio (SAR)	-	12		15	16	15	39	28	36	13	16
Chloride	mg/kg	-		3000	3100	3900	820	1600	1400	340	140
Calcium	mg/kg	-		380	490	620	22	110	99	31	14
Magnesium	mg/kg	-		150	140	160	2.2	18	2.5	6.3	1.8
Potassium	mg/kg	-		10	12	19	7.6	6.1	7.2	3.1	1.7
Sodium	mg/kg	-		1200	1200	1400	580	1000	890	250	160
Sulphate	mg/kg	-		69	130	160	46	190	260	100	42
Saturation	%	-		74	63	77	65	78	45	66	46
Moisture	%	-		27	26	27	12	22	21	31	22
Soil Texture	NA	-		-	-	-	FINE	-	-	-	FINE
Sieve - #200 (>0.075mm)	%	-		-	-	-	25	-	-	-	17
Metals	Antimony	mg/kg		40	<0.50	<0.50	<0.50	<0.50	<0.50	<0.50	<0.50
	Arsenic	mg/kg	26	8.4	7.7	9.9	5.8	8.8	6.5	7.9	5.5
	Barium	mg/kg	2000	220	200	240	180	210	180	200	170
	Beryllium	mg/kg	8	0.67	0.68	0.87	0.62	0.77	<0.40	0.73	0.59
	Boron	mg/L	5.0	<0.10	<0.10	<0.10	0.15	<0.10	0.12	<0.10	<0.10
	Cadmium	mg/kg	22	0.31	0.25	0.40	0.32	0.24	0.29	0.20	0.17
	Chromium	mg/kg	87	23	22	30	28	28	26	73	60
	Chromium (hexavalent)	mg/kg	1.4	<0.080	<0.080	<0.080	<0.080	<0.080	<0.080	<0.080	<0.080
	Cobalt	mg/kg	300	10	10	12	8.6	12	7.9	11	8.7
	Copper	mg/kg	91	28	29	29	22	27	13	25	17
	Lead	mg/kg	260	13	12	14	22	15	9.9	15	10
	Mercury	mg/kg	24	<0.050	<0.050	<0.050	<0.050	<0.050	<0.050	<0.050	<0.050
	Molybdenum	mg/kg	40	1.1	0.99	1.1	1.2	1.1	1.2	2.1	1.6
	Nickel	mg/kg	89	28	27	34	26	35	25	52	41
	Selenium	mg/kg	2.9	<0.50	0.81	0.92	<0.50	<0.50	<0.50	<0.50	<0.50
	Silver	mg/kg	40	<0.20	<0.20	<0.20	<0.20	<0.20	<0.20	<0.20	<0.20
	Thallium	mg/kg	1	0.22	0.19	0.29	0.14	0.21	0.16	0.19	0.12
	Tin	mg/kg	300	<1.0	<1.0	<1.0	<1.0	<1.0	<1.0	<1.0	<1.0
Uranium	mg/kg	33	1.1	1.3	1.4	0.61	1.1	0.94	0.88	1.2	
Vanadium	mg/kg	130	33	33	45	29	39	22	35	30	
Zinc	mg/kg	410	81	84	92	85	81	53	72	63	

Notes:

AT1 - Alberta Environment and Parks (AEP). 2019. Alberta Tier 1 Soil and Groundwater Remediation Guidelines. Land Policy Branch, Policy and Planning Division. 198 pp (Commercial land use and Fine-grained surface soil criteria)

Shading indicates result exceeds AT1 Guidelines for Commercial Land Use

- Not analyzed/No Guideline



Project: 2021-3981

Sample Location		21HA16		21HA17		21HA19			
Depth (m)		0.0-0.3	0.6-1.0	0.0-0.3	0.6-1.0	0.0-0.3	0.6-1.0		
Duplicates		-	-	-	-	-	-		
Date Sampled		4-Jun-21	4-Jun-21	4-Jun-21	4-Jun-21	4-Jun-21	4-Jun-21		
Lab ID		ZY0064	ZY0065	ZY0066	ZY0067	ZY0070	ZY0071		
Parameter	Units	AT1 Residential/Parkland Fine	Rainbow Valley Bridge						
Salinity & Physical Parameters	pH (1:2 CaCl2)	pH units	6-8.5	7.86	7.86	7.61	7.84	7.32	7.85
	Conductivity (Sat. Paste)	dS/m	See ratings table	6.4	2.8	7.0	4.5	100	7.5
	Sodium Adsorption Ratio (SAR)	-	See ratings table	23	14	17	17	60	14
	Chloride	mg/kg	-	1200	470	1400	940	20000	1300
	Calcium	mg/kg	-	77	38	150	74	2800	250
	Magnesium	mg/kg	-	17	9.9	29	16	1100	59
	Potassium	mg/kg	-	19	8.6	5.0	9.0	190	22
	Sodium	mg/kg	-	660	310	680	510	10000	820
	Sulphate	mg/kg	-	35	72	42	50	1400	670
	Saturation	%	-	61	64	62	68	48	71
	Moisture	%	-	16	19	23	19	19	21
	Soil Texture	NA	-	-	-	-	-	-	-
	Sieve - #200 (>0.075mm)	%	-	-	-	-	-	-	-
	Metals	Antimony	mg/kg	20	<0.50	<0.50	<0.50	<0.50	<0.50
Arsenic		mg/kg	17	9.2	13	6.4	7.6	5.4	8.5
Barium		mg/kg	500	180	210	190	220	150	210
Beryllium		mg/kg	5	0.55	0.62	0.61	0.73	0.55	0.70
Boron		mg/L	3.3	<0.10	<0.10	<0.10	<0.10	0.31	<0.10
Cadmium		mg/kg	10	0.26	0.28	0.33	0.27	0.26	0.33
Chromium		mg/kg	64	31	20	29	27	39	21
Chromium (hexavalent)		mg/kg	0.4	<0.080	<0.080	<0.080	<0.080	<0.080	<0.080
Cobalt		mg/kg	20	9.6	10	8.3	9.5	8.1	9.7
Copper		mg/kg	63	20	20	18	21	29	25
Lead		mg/kg	140	19	9.8	11	13	27	13
Mercury		mg/kg	6.6	<0.050	<0.050	<0.050	<0.050	<0.050	<0.050
Molybdenum		mg/kg	4	1.2	1.2	0.89	1.2	1.5	1.2
Nickel		mg/kg	45	27	27	27	28	26	26
Selenium		mg/kg	1	<0.50	<0.50	0.53	<0.50	0.80	<0.50
Silver		mg/kg	20	<0.20	<0.20	0.71	<0.20	<0.20	<0.20
Thallium		mg/kg	1	0.17	0.18	0.15	0.18	0.13	0.25
Tin		mg/kg	5	<1.0	<1.0	<1.0	<1.0	<1.0	<1.0
Uranium		mg/kg	23	1.3	1.5	1.5	1.5	1.1	1.9
Vanadium	mg/kg	130	28	24	30	24	34	25	
Zinc	mg/kg	250	77	68	65	67	100	67	

Notes:

AT1 - Alberta Environment and Parks (AEP). 2019. Alberta Tier 1 Soil and Groundwater Remediation Guidelines. Land Policy Branch, Policy and Planning Division. 198 pp (Residential/Parkland land use and Fine-grained surface soil criteria)

Shading indicates result exceeds AT1 Guidelines for Residential/Parkland Land Use

- Not analyzed/No Guideline

AT1 Table 4: Alberta Tier 1 Salt Remediation Guidelines

Rating Category	Good	Fair	Poor	Unsuitable
Topsoil (0.0-0.3 m)				
Conductivity dS/m	<2	2 to 4	4 to 8	>8
SAR	<4	4 to 8	8 to 12	>12
Subsoil (>0.3 m)				
Conductivity dS/m	<3	3 to 5	5 to 10	>10
SAR	<4	4 to 8	8 to 12	>12

Table 2. Soil Analytical Results - Petroleum Hydrocarbons, Polycyclic Aromatic Hydrocarbons - Commercial Guidelines
Project: 2021-3981

			Sample Location	21HA01	21HA02	21HA03	21HA05	21HA06	21HA07
			Depth (m)	0.0-0.3	0.0-0.3	0.0-0.3	0.0-0.3	0.0-0.3	0.6-1.0
			Duplicates	-	-	-	-	-	-
			Date Sampled	2-Jun-21	3-Jun-21	3-Jun-21	3-Jun-21	3-Jun-21	3-Jun-21
			Lab ID	ZY0019	ZY0021	ZY0023	ZY0027	ZY0044	ZY0047
Parameter	Units	AT1 Commercial Fine	Whitemud Drive Southbound Fox Drive to 53 Ave NW						
			Petroleum Hydrocarbons						
Benzene	mg/kg	0.046	<0.0050	<0.0050	<0.0050	<0.0050	<0.0050	<0.0050	<0.0050
Toluene	mg/kg	0.52	<0.050	<0.050	<0.050	<0.050	<0.050	<0.050	<0.050
Ethylbenzene	mg/kg	0.073	<0.010	<0.010	<0.010	<0.010	<0.010	<0.010	<0.010
Total Xylenes	mg/kg	0.99	<0.045	<0.045	<0.045	<0.045	<0.045	<0.045	<0.045
F1-BTEX	mg/kg	320	<10	<10	<10	<10	<10	<10	<10
Fraction 2 (C11-C16)	mg/kg	260	<10	<10	<10	<10	<10	<10	<10
Fraction 3 (C16-C34)	mg/kg	2,500	51	<50	<50	67	72	<50	<50
Fraction 4 (C34-C50)	mg/kg	6,600	<50	<50	<50	68	<50	<50	<50
Fraction 4G - SG	mg/kg	-	-	-	-	-	-	-	-
Chrom. To baseline at nC50	-	-	Yes	Yes	Yes	Yes	Yes	Yes	Yes
Polycyclic Aromatic Hydrocarbons									
Non-Carcinogenic PAH									
Acenaphthene	mg/kg	0.33	<0.0050	-	-	-	-	-	<0.0050
Acenaphthylene	mg/kg	-	<0.0050	-	-	-	-	-	<0.0050
Anthracene	mg/kg	1.3	<0.0040	-	-	-	-	-	<0.0040
Fluoranthene	mg/kg	180	<0.0050	-	-	-	-	-	<0.0050
Fluorene	mg/kg	0.40	<0.0050	-	-	-	-	-	<0.0050
Naphthalene	mg/kg	0.014	<0.0050	-	-	-	-	-	<0.0050
Phenanthrene	mg/kg	0.11	<0.0050	-	-	-	-	-	<0.0050
Pyrene	mg/kg	3,200	<0.0050	-	-	-	-	-	<0.0050
Carcinogenic PAH									
Benzo(a)anthracene	mg/kg	-	<0.0050	-	-	-	-	-	<0.0050
Benzo(a)pyrene	mg/kg	72	<0.0050	-	-	-	-	-	<0.0050
Benzo(b+j)fluoranthene	mg/kg	-	<0.0050	-	-	-	-	-	<0.0050
Benzo(g,h,i)perylene	mg/kg	-	<0.0050	-	-	-	-	-	<0.0050
Benzo(k)fluoranthene	mg/kg	-	<0.0050	-	-	-	-	-	<0.0050
Chrysene	mg/kg	-	<0.0050	-	-	-	-	-	<0.0050
Dibenzo(a,h)anthracene	mg/kg	-	<0.0050	-	-	-	-	-	<0.0050
Indeno(1,2,3-c,d)pyrene	mg/kg	-	<0.0050	-	-	-	-	-	<0.0050
IACR Coarse	mg/kg	1.0	<0.10	-	-	-	-	-	<0.10
IACR Fine	mg/kg	1.0	<0.10	-	-	-	-	-	<0.10
B(a)P Total Potency Equivalents	mg/kg	8.0	<0.0071	-	-	-	-	-	<0.0071

Notes:

AT1 - Alberta Environment and Parks (AEP). 2019. Alberta Tier 1 Soil and Groundwater Remediation Guidelines. Land Policy Branch, Policy and Planning Division. 198 pp (Commercial land use and Fine-grained surface soil criteria)

Shading indicates result exceeds AT1 Guidelines for Commercial Land Use

- Not analyzed/No Guideline

Table 2. Soil Analytical Results - Petroleum Hydrocarbons, Polycyclic Aromatic Hydrocarbons - Commercial Guidelines
Project: 2021-3981

		Sample Location	21HA08	21HA09		21HA10	21HA11	21HA12	21HA30
		Depth (m)	0.0-0.3	0.0-0.3		0.0-0.3	0.0-0.3	0.0-0.3	0.6-1.0
		Duplicates	-	-	DUP3	-	-	-	-
		Date Sampled	3-Jun-21	3-Jun-21	2-Jun-21	3-Jun-21	3-Jun-21	3-Jun-21	2-Jun-21
		Lab ID	ZY0048	ZY0050	ZY0096	ZY0052	ZY0054	ZY0056	ZY0093
Parameter	Units	AT1 Commercial Fine	Whitemud Drive Southbound 53 Ave NW to Terwillager Drive Overpass			Whitemud Drive Eastbound Terwillager Drive to Rainbow Valley Bridge		Whitemud Drive Eastbound Rainbow Valley Bridge to 122 St NW	
			Petroleum Hydrocarbons						
Benzene	mg/kg	0.046	<0.0050	<0.0050	<0.0050	<0.0050	<0.0050	<0.0050	<0.0050
Toluene	mg/kg	0.52	<0.050	<0.050	<0.050	<0.050	<0.050	<0.050	<0.050
Ethylbenzene	mg/kg	0.073	<0.010	<0.010	<0.010	<0.010	<0.010	<0.010	<0.010
Total Xylenes	mg/kg	0.99	<0.045	<0.045	<0.045	<0.045	<0.045	<0.045	<0.045
F1-BTEX	mg/kg	320	<10	<10	<10	<10	<10	<10	<10
Fraction 2 (C11-C16)	mg/kg	260	<10	<10	<10	<10	<10	<10	<10
Fraction 3 (C16-C34)	mg/kg	2,500	61	82	62	180	110	120	<50
Fraction 4 (C34-C50)	mg/kg	6,600	<50	58	<50	200	54	78	<50
Fraction 4G - SG	mg/kg	-	-	-	-	-	-	-	-
Chrom. To baseline at nC50	-	-	Yes	Yes	Yes	Yes	Yes	Yes	Yes
Non-Carcinogenic PAH									
Acenaphthene	mg/kg	0.33	<0.0050	<0.0050	<0.0050	-	<0.0050	-	-
Acenaphthylene	mg/kg	-	<0.0050	<0.0050	<0.0050	-	<0.0050	-	-
Anthracene	mg/kg	1.3	<0.0040	<0.0040	<0.0040	-	<0.0040	-	-
Fluoranthene	mg/kg	180	0.037	<0.0050	<0.0050	-	<0.0050	-	-
Fluorene	mg/kg	0.40	<0.0050	<0.0050	<0.0050	-	<0.0050	-	-
Naphthalene	mg/kg	0.014	<0.0050	<0.0050	<0.0050	-	<0.0050	-	-
Phenanthrene	mg/kg	0.11	0.019	<0.0050	<0.0050	-	<0.0050	-	-
Pyrene	mg/kg	3,200	0.033	0.0062	<0.0050	-	0.020	-	-
Carcinogenic PAH									
Benzo(a)anthracene	mg/kg	-	0.014	<0.0050	<0.0050	-	<0.0050	-	-
Benzo(a)pyrene	mg/kg	72	0.015	<0.0050	<0.0050	-	<0.0050	-	-
Benzo(b+j)fluoranthene	mg/kg	-	0.021	0.0065	<0.0050	-	0.012	-	-
Benzo(g,h,i)perylene	mg/kg	-	0.011	0.0080	<0.0050	-	0.0063	-	-
Benzo(k)fluoranthene	mg/kg	-	0.0063	<0.0050	<0.0050	-	<0.0050	-	-
Chrysene	mg/kg	-	0.012	<0.0050	<0.0050	-	<0.0050	-	-
Dibenzo(a,h)anthracene	mg/kg	-	<0.0050	<0.0050	<0.0050	-	<0.0050	-	-
Indeno(1,2,3-c,d)pyrene	mg/kg	-	0.0094	<0.0050	<0.0050	-	<0.0050	-	-
IACR Coarse	mg/kg	1.0	<0.10	<0.10	<0.10	-	<0.10	-	-
IACR Fine	mg/kg	1.0	<0.10	<0.10	<0.10	-	<0.10	-	-
B(a)P Total Potency Equivalents	mg/kg	8.0	0.023	<0.0071	<0.0071	-	<0.0071	-	-

Notes:

AT1 - Alberta Environment and Parks (AEP). 2019. Alberta Tier 1 Soil and Groundwater Remediation Guidelines. Land Policy Branch, Policy and Planning Division. 198 pp (Commercial land use and Fine-grained surface soil criteria)

Shading indicates result exceeds AT1 Guidelines for Commercial Land Use

- Not analyzed/No Guideline

Table 2. Soil Analytical Results - Petroleum Hydrocarbons, Polycyclic Aromatic Hydrocarbons - Commercial Guidelines
Project: 2021-3981

Sample Location		21HA21	21HA22	21HA18	21HA20	21HA23	21HA24		
Depth (m)		0.0-0.3	0.0-0.3	0.0-0.3	0.6-1.0	0.0-0.3	0.0-0.3		
Duplicates		-	DUP1	-	-	-	-		
Date Sampled		2-Jun-21	2-Jun-21	2-Jun-21	3-Jun-21	3-Jun-21	2-Jun-21		
Lab ID		ZY0074	ZY0094	ZY0076	ZY0068	ZY0073	ZY0080		
Parameter	Units	AT1 Commercial Fine	Whitemud Drive Westbound 122 St NW to Rainbow Valley Bridge				Whitemud Drive Westbound Rainbow Valley Bridge to Terwillegar Drive		
Petroleum Hydrocarbons	Benzene	mg/kg	0.046	<0.0050	<0.0050	<0.0050	<0.0050	<0.0050	<0.0050
	Toluene	mg/kg	0.52	<0.050	<0.050	<0.050	<0.050	<0.050	<0.050
	Ethylbenzene	mg/kg	0.073	<0.010	<0.010	<0.010	<0.010	<0.010	<0.010
	Total Xylenes	mg/kg	0.99	<0.045	<0.045	<0.045	<0.045	<0.045	<0.045
	F1-BTEX	mg/kg	320	<10	<10	<10	<10	<10	<10
	Fraction 2 (C11-C16)	mg/kg	260	<10	<10	<10	<10	<10	<10
	Fraction 3 (C16-C34)	mg/kg	2,500	78	<50	67	76	91	<50
	Fraction 4 (C34-C50)	mg/kg	6,600	62	<50	<50	<50	62	<50
	Fraction 4G - SG	mg/kg	-	-	-	-	-	-	4300
	Chrom. To baseline at nC50	-	-	Yes	Yes	Yes	Yes	Yes	Yes
Non-Carcinogenic PAH									
Polycyclic Aromatic Hydrocarbons	Acenaphthene	mg/kg	0.33	-	-	<0.0050	<0.0050	-	-
	Acenaphthylene	mg/kg	-	-	-	<0.0050	<0.0050	-	-
	Anthracene	mg/kg	1.3	-	-	<0.0040	<0.0040	-	-
	Fluoranthene	mg/kg	180	-	-	<0.0050	0.0079	-	-
	Fluorene	mg/kg	0.40	-	-	<0.0050	<0.0050	-	-
	Naphthalene	mg/kg	0.014	-	-	<0.0050	<0.0050	-	-
	Phenanthrene	mg/kg	0.11	-	-	<0.0050	0.0088	-	-
	Pyrene	mg/kg	3,200	-	-	<0.0050	0.0072	-	-
	Carcinogenic PAH								
	Benzo(a)anthracene	mg/kg	-	-	-	<0.0050	<0.0050	-	-
	Benzo(a)pyrene	mg/kg	72	-	-	<0.0050	<0.0050	-	-
	Benzo(b+j)fluoranthene	mg/kg	-	-	-	<0.0050	<0.0050	-	-
	Benzo(g,h,i)perylene	mg/kg	-	-	-	<0.0050	<0.0050	-	-
	Benzo(k)fluoranthene	mg/kg	-	-	-	<0.0050	<0.0050	-	-
	Chrysene	mg/kg	-	-	-	<0.0050	<0.0050	-	-
Dibenzo(a,h)anthracene	mg/kg	-	-	-	<0.0050	<0.0050	-	-	
Indeno(1,2,3-c,d)pyrene	mg/kg	-	-	-	<0.0050	<0.0050	-	-	
IACR Coarse	mg/kg	1.0	-	-	<0.10	<0.10	-	-	
IACR Fine	mg/kg	1.0	-	-	<0.10	<0.10	-	-	
B(a)P Total Potency Equivalents	mg/kg	8.0	-	-	<0.0071	<0.0071	-	-	

Notes:

AT1 - Alberta Environment and Parks (AEP). 2019. Alberta Tier 1 Soil and Groundwater Remediation Guidelines. Land Policy Branch, Policy and Planning Division. 198 pp (Commercial land use and Fine-grained surface soil criteria)

Shading indicates result exceeds AT1 Guidelines for Commercial Land Use

- Not analyzed/No Guideline

Table 2. Soil Analytical Results - Petroleum Hydrocarbons, Polycyclic Aromatic Hydrocarbons - Commercial Guidelines
Project: 2021-3981

		Sample Location	21HA25	21HA26		21HA27	21HA28	21HA29	21HA04
		Depth (m)	0.0-0.3	0.6-1.0		0.6-1.0	0.0-0.3	0.0-0.3	0.6-1.0
		Duplicates	-	-	DUP2	-	-	-	-
		Date Sampled	2-Jun-21	2-Jun-21	2-Jun-21	2-Jun-21	2-Jun-21	2-Jun-21	2-Jun-21
		Lab ID	ZY0082	ZY0085	ZY0095	ZY0086	ZY0088	ZY0090	ZY0026
Parameter	Units	AT1 Commercial Fine	Whitemud Drive Northbound Terwillegar Drive to 53 Ave NW			Whitemud Drive Northbound 53 Ave NW to Fox Drive			
Petroleum Hydrocarbons	Benzene	mg/kg	0.046	<0.0050	<0.0050	<0.0050	<0.0050	<0.0050	<0.0050
	Toluene	mg/kg	0.52	<0.050	<0.050	<0.050	<0.050	<0.050	<0.050
	Ethylbenzene	mg/kg	0.073	<0.010	<0.010	<0.010	<0.010	<0.010	<0.010
	Total Xylenes	mg/kg	0.99	<0.045	<0.045	<0.045	<0.045	<0.045	<0.045
	F1-BTEX	mg/kg	320	<10	<10	<10	<10	<10	<10
	Fraction 2 (C11-C16)	mg/kg	260	<10	<10	<10	<10	<10	<10
	Fraction 3 (C16-C34)	mg/kg	2,500	83	68	82	<50	150	100
	Fraction 4 (C34-C50)	mg/kg	6,600	56	<50	<50	<50	130	63
	Fraction 4G - SG	mg/kg	-	-	-	-	-	-	-
	Chrom. To baseline at nC50	-	-	Yes	Yes	Yes	Yes	Yes	Yes
Non-Carcinogenic PAH									
Polycyclic Aromatic Hydrocarbons	Acenaphthene	mg/kg	0.33	<0.0050	-	-	-	<0.0050	<0.0050
	Acenaphthylene	mg/kg	-	<0.0050	-	-	-	<0.0050	<0.0050
	Anthracene	mg/kg	1.3	<0.0040	-	-	-	<0.0040	<0.0040
	Fluoranthene	mg/kg	180	<0.0050	-	-	-	<0.0050	<0.0050
	Fluorene	mg/kg	0.40	<0.0050	-	-	-	<0.0050	<0.0050
	Naphthalene	mg/kg	0.014	<0.0050	-	-	-	<0.0050	<0.0050
	Phenanthrene	mg/kg	0.11	<0.0050	-	-	-	<0.0050	<0.0050
	Pyrene	mg/kg	3,200	<0.0050	-	-	-	<0.0050	0.021
	Carcinogenic PAH								
	Benzo(a)anthracene	mg/kg	-	<0.0050	-	-	-	<0.0050	<0.0050
	Benzo(a)pyrene	mg/kg	72	<0.0050	-	-	-	<0.0050	0.0073
	Benzo(b+j)fluoranthene	mg/kg	-	<0.0050	-	-	-	<0.0050	0.011
	Benzo(g,h,i)perylene	mg/kg	-	<0.0050	-	-	-	<0.0050	<0.0050
	Benzo(k)fluoranthene	mg/kg	-	<0.0050	-	-	-	<0.0050	<0.0050
	Chrysene	mg/kg	-	<0.0050	-	-	-	<0.0050	<0.0050
Dibenzo(a,h)anthracene	mg/kg	-	<0.0050	-	-	-	<0.0050	<0.0050	
Indeno(1,2,3-c,d)pyrene	mg/kg	-	<0.0050	-	-	-	<0.0050	<0.0050	
IACR Coarse	mg/kg	1.0	<0.10	-	-	-	<0.10	<0.10	
IACR Fine	mg/kg	1.0	<0.10	-	-	-	<0.10	<0.10	
B(a)P Total Potency Equivalents	mg/kg	8.0	<0.0071	-	-	-	<0.0071	0.012	

Notes:

AT1 - Alberta Environment and Parks (AEP). 2019. Alberta Tier 1 Soil and Groundwater Remediation Guidelines. Land Policy Branch, Policy and Planning Division. 198 pp (Commercial land use and Fine-grained surface soil criteria)

Shading indicates result exceeds AT1 Guidelines for Commercial Land Use

- Not analyzed/No Guideline

Project: 2021-3981

Parameter		Units	AT1 Residential/Parkland Fine	Rainbow Valley Bridge		
Petroleum Hydrocarbons	Benzene	mg/kg	0.046	<0.0050	<0.0050	<0.0050
	Toluene	mg/kg	0.52	<0.050	<0.050	<0.050
	Ethylbenzene	mg/kg	0.073	<0.010	<0.010	<0.010
	Total Xylenes	mg/kg	0.99	<0.045	<0.045	<0.045
	F1-BTEX	mg/kg	210	<10	<10	<10
	Fraction 2 (C11-C16)	mg/kg	150	<10	<10	<10
	Fraction 3 (C16-C34)	mg/kg	1,300	63	73	97
	Fraction 4 (C34-C50)	mg/kg	5,600	<50	<50	58
	Fraction 4G - SG	mg/kg	-	-	-	-
	Chrom. To baseline at nC50	-	-	Yes	Yes	Yes

Notes:

Guideline - Alberta Environment and Parks (AEP). 2019. Alberta Tier 1 Soil and Groundwater Remediation Guidelines. Land Policy Branch, Policy and Planning Division. 198 pp (Residential/Parkland land use and Fine-grained surface soil criteria)

Shading indicates result exceeds AT1 Guidelines for Residential/Parkland Land Use

- Not analyzed/No Guideline



Table 3. Soil Analytical Results - Per- and Polyfluoroalkyls Substances
Project: 2021-3981

		Sample Location	21HA13	21HA14	21HA15			
		Depth (m)	1.0-1.3	1.0-1.3	1.0-1.3			
		Duplicates	-	-	-			
		Date Sampled	4-Jun-21	4-Jun-21	4-Jun-21			
		Lab ID	ZY0059	ZY0061	ZY0063			
Parameter	Units	Guideline Residential/Parkland						
		BC CSR	CCME	Health Canada				
Perfluoroalkylated Compounds	Perfluorobutanoic acid (PFBA)	mg/kg	-	-	114	<0.001	<0.001	<0.001
	Perfluoropentanoic Acid (PFPeA)	mg/kg	-	-	0.8	<0.001	<0.001	<0.001
	Perfluorohexanoic Acid (PFHxA)	mg/kg	-	-	0.8	<0.001	<0.001	<0.001
	Perfluoroheptanoic Acid (PFHpA)	mg/kg	-	-	0.8	<0.001	<0.001	<0.001
	Perfluorooctanoic Acid (PFOA)	mg/kg	-	-	0.7	<0.001	<0.001	0.0011
	Perfluorononanoic Acid (PFNA)	mg/kg	-	-	0.08	<0.001	<0.001	<0.001
	Perfluorodecanoic Acid (PFDA)	mg/kg	-	-	-	<0.001	<0.001	<0.001
	Perfluoroundecanoic Acid (PFUnA)	mg/kg	-	-	-	<0.001	<0.001	<0.001
	Perfluorododecanoic Acid (PFDoA)	mg/kg	-	-	-	<0.001	<0.001	<0.001
	Perfluorotridecanoic Acid	mg/kg	-	-	-	<0.001	<0.001	<0.001
	Perfluorotetradecanoic Acid	mg/kg	-	-	-	<0.001	<0.001	<0.001
	Perfluorobutanesulfonic acid	mg/kg	-	-	-	<0.001	<0.001	<0.001
	Perfluoropentanesulfonic acid	mg/kg	-	-	-	<0.001	<0.001	<0.001
	Perfluorohexanesulfonic acid	mg/kg	-	-	-	<0.001	<0.001	<0.001
	Perfluoroheptanesulfonic acid	mg/kg	-	-	-	<0.001	<0.001	<0.001
	Perfluorooctanesulfonic acid (PFOS)	mg/kg	0.35	0.01	2.1	<0.001	<0.001	<0.001
	Perfluorononane sulfonic acid	mg/kg	-	-	-	<0.001	<0.001	<0.001
Perfluorodecanesulfonic acid (PFDS)	mg/kg	-	-	-	<0.001	<0.001	<0.001	
Perfluorooctane Sulfonamide (PFOSA)	mg/kg	-	-	-	<0.001	<0.001	<0.001	

Notes:

BC CSR (RL_D) - British Columbia (BC) Contaminated Sites Regulation (CSR), Schedule 3.3. Generic Numerical Soil Standards (BC Reg. 375/96) (Low Density Residential Land Use)

CCME - Canadian Council of Ministers of the Environment. Canadian Environmental Quality Guidelines: Soil Quality Guidelines for the Protection of Environmental and Human Health. Final Proposed Federal Soil Quality Guideline. Residential/Parkland land use for fine-grained surface soils.

Health Canada - Updates to Health Canada Soil Screening Values for Perfluoroalkylated Substances (PFAS).

- Not analyzed/No Guideline

			21HA21 (0.0-0.3m)	DUP1	Relative Percent Difference (%)	
Date Sampled			2-Jun-21			
Parameter	Units	LDL				
Salinity & Physical Parameters	pH (1:2 CaCl2)	pH units	0.10	8.09	8.01	1
	Conductivity (Sat. Paste)	dS/m	0.020	5.3	4.6	14
	Sodium Adsorption Ratio (SAR)	-	0.10	28	27	4
	Chloride	mg/kg	7.1	1100	820	29
	Calcium	mg/kg	0.5	55	39	34
	Magnesium	mg/kg	0.36	9.6	6.3	42
	Potassium	mg/kg	0.46	7.7	6.0	25
	Sodium	mg/kg	0.89	690	550	23
	Sulphate	mg/kg	1.8	84	62	30
	Saturation	%	-	67	63	6
	Moisture	%	0.30	18	21	15
Metals	Antimony	mg/kg	0.50	<0.50	<0.50	-
	Arsenic	mg/kg	1.0	8.5	6.4	28
	Barium	mg/kg	1.0	200	170	16
	Beryllium	mg/kg	0.40	0.74	0.56	-
	Boron	mg/L	0.10	0.12	0.14	-
	Cadmium	mg/kg	0.050	0.29	0.27	7
	Chromium	mg/kg	1.0	35	29	19
	Chromium (hexavalent)	mg/kg	0.080	<0.080	<0.080	-
	Cobalt	mg/kg	0.50	9.9	8.5	15
	Copper	mg/kg	1.0	23	22	4
	Lead	mg/kg	0.50	13	13	0
	Mercury	mg/kg	0.050	<0.050	<0.050	-
	Molybdenum	mg/kg	0.40	1.2	1.1	-
	Nickel	mg/kg	1.0	32	27	17
	Selenium	mg/kg	0.50	0.58	<0.50	-
	Silver	mg/kg	0.20	<0.20	<0.20	-
	Thallium	mg/kg	0.10	0.20	0.17	-
	Tin	mg/kg	1.0	<1.0	<1.0	-
Uranium	mg/kg	0.20	2.0	1.9	5	
Vanadium	mg/kg	1.0	35	31	12	
Zinc	mg/kg	10	80	76	5	
Petroleum Hydrocarbons	Benzene	mg/kg	0.0050	<0.0050	<0.0050	-
	Toluene	mg/kg	0.050	<0.050	<0.050	-
	Ethylbenzene	mg/kg	0.010	<0.010	<0.010	-
	Total Xylenes	mg/kg	0.045	<0.045	<0.045	-
	F1-BTEX	mg/kg	10	<10	<10	-
	Fraction 2 (C11-C16)	mg/kg	10	<10	<10	-
	Fraction 3 (C16-C34)	mg/kg	50	78	<50	-
	Fraction 4 (C34-C50)	mg/kg	50	62	<50	-
Non-Carcinogenic PAH	Acenaphthene	mg/kg	0.0050	-	-	-
	Acenaphthylene	mg/kg	0.0050	-	-	-
	Anthracene	mg/kg	0.0040	-	-	-
	Fluoranthene	mg/kg	0.0050	-	-	-
	Fluorene	mg/kg	0.0050	-	-	-
	Naphthalene	mg/kg	0.0050	-	-	-
	Phenanthrene	mg/kg	0.0050	-	-	-
	Pyrene	mg/kg	0.0050	-	-	-
Carcinogenic PAH	Benzo(a)anthracene	mg/kg	0.0050	-	-	-
	Benzo(a)pyrene	mg/kg	0.0050	-	-	-
	Benzo(b+j)fluoranthene	mg/kg	0.0050	-	-	-
	Benzo(g,h,i)perylene	mg/kg	0.0050	-	-	-
	Benzo(k)fluoranthene	mg/kg	0.0050	-	-	-
	Chrysene	mg/kg	0.0050	-	-	-
	Dibenzo(a,h)anthracene	mg/kg	0.0050	-	-	-
	Indeno(1,2,3-c,d)pyrene	mg/kg	0.0050	-	-	-

Notes:

- Not analyzed / Result not 5x more than LDL

Shading indicates RPD values greater than 50%

LDL - Lowest Detection Limit

* Individual analyte detection limit reported to be greater than overall LDL

			21HA26 (0.6-1.0m)	DUP2	Relative Percent Difference (%)	
Date Sampled			2-Jun-21			
Parameter	Units	LDL				
Salinity & Physical Parameters	pH (1:2 CaCl ₂)	pH units	0.10	7.52	7.53	0
	Conductivity (Sat. Paste)	dS/m	0.020	14	15	7
	Sodium Adsorption Ratio (SAR)	-	0.10	16	15	6
	Chloride	mg/kg	7.1	3100	3900	23
	Calcium	mg/kg	0.5	490	620	23
	Magnesium	mg/kg	0.36	140	160	13
	Potassium	mg/kg	0.46	12	19	45
	Sodium	mg/kg	0.89	1200	1400	15
	Sulphate	mg/kg	1.8	130	160	21
	Saturation	%	-	63	77	20
	Moisture	%	0.30	26	27	4
Metals	Antimony	mg/kg	0.50	<0.50	<0.50	-
	Arsenic	mg/kg	1.0	7.7	9.9	25
	Barium	mg/kg	1.0	200	240	18
	Beryllium	mg/kg	0.40	0.68	0.87	-
	Boron	mg/L	0.10	<0.10	<0.10	-
	Cadmium	mg/kg	0.050	0.25	0.40	-
	Chromium	mg/kg	1.0	22	30	31
	Chromium (hexavalent)	mg/kg	0.080	<0.080	<0.080	-
	Cobalt	mg/kg	0.50	10	12	18
	Copper	mg/kg	1.0	29	29	0
	Lead	mg/kg	0.50	12	14	15
	Mercury	mg/kg	0.050	<0.050	<0.050	-
	Molybdenum	mg/kg	0.40	0.99	1.1	-
	Nickel	mg/kg	1.0	27	34	23
	Selenium	mg/kg	0.50	0.81	0.92	-
	Silver	mg/kg	0.20	<0.20	<0.20	-
	Thallium	mg/kg	0.10	0.19	0.29	-
	Tin	mg/kg	1.0	<1.0	<1.0	-
Uranium	mg/kg	0.20	1.3	1.4	7	
Vanadium	mg/kg	1.0	33	45	31	
Zinc	mg/kg	10	84	92	9	
Petroleum Hydrocarbons	Benzene	mg/kg	0.0050	<0.0050	<0.0050	-
	Toluene	mg/kg	0.050	<0.050	<0.050	-
	Ethylbenzene	mg/kg	0.010	<0.010	<0.010	-
	Total Xylenes	mg/kg	0.045	<0.045	<0.045	-
	F1-BTEX	mg/kg	10	<10	<10	-
	Fraction 2 (C11-C16)	mg/kg	10	<10	<10	-
	Fraction 3 (C16-C34)	mg/kg	50	68	82	-
Fraction 4 (C34-C50)	mg/kg	50	<50	<50	-	
Non-Carcinogenic PAH	Acenaphthene	mg/kg	0.0050	-	-	-
	Acenaphthylene	mg/kg	0.0050	-	-	-
	Anthracene	mg/kg	0.0040	-	-	-
	Fluoranthene	mg/kg	0.0050	-	-	-
	Fluorene	mg/kg	0.0050	-	-	-
	Naphthalene	mg/kg	0.0050	-	-	-
	Phenanthrene	mg/kg	0.0050	-	-	-
	Pyrene	mg/kg	0.0050	-	-	-
Carcinogenic PAH	Benzo(a)anthracene	mg/kg	0.0050	-	-	-
	Benzo(a)pyrene	mg/kg	0.0050	-	-	-
	Benzo(b+j)fluoranthene	mg/kg	0.0050	-	-	-
	Benzo(g,h,i)perylene	mg/kg	0.0050	-	-	-
	Benzo(k)fluoranthene	mg/kg	0.0050	-	-	-
	Chrysene	mg/kg	0.0050	-	-	-
	Dibenzo(a,h)anthracene	mg/kg	0.0050	-	-	-
	Indeno(1,2,3-c,d)pyrene	mg/kg	0.0050	-	-	-

Notes:

- Not analyzed / Result not 5x more than LDL

Shading indicates RPD values greater than 50%

LDL - Lowest Detection Limit

* Individual analyte detection limit reported to be greater than overall LD

			21HA09 (0.0-0.3m)	DUP3	Relative Percent Difference (%)	
Date Sampled			3-Jun-21			
Parameter	Units	LDL				
Salinity & Physical Parameters	pH (1:2 CaCl2)	pH units	0.10	7.78	7.62	2
	Conductivity (Sat. Paste)	dS/m	0.020	2.7	2.2	20
	Sodium Adsorption Ratio (SAR)	-	0.10	27	23	16
	Chloride	mg/kg	7.1	230	180	24
	Calcium	mg/kg	0.5	12	8.7	32
	Magnesium	mg/kg	0.36	1.4	1.1	-
	Potassium	mg/kg	0.46	3.9	3.0	26
	Sodium	mg/kg	0.89	220	160	32
	Sulphate	mg/kg	1.8	37	20	60
	Saturation	%	-	38	36	5
	Moisture	%	0.30	20	19	5
Metals	Antimony	mg/kg	0.50	<0.50	0.52	-
	Arsenic	mg/kg	1.0	5.9	4.0	-
	Barium	mg/kg	1.0	180	110	48
	Beryllium	mg/kg	0.40	0.60	<0.40	-
	Boron	mg/L	0.10	0.12	0.10	-
	Cadmium	mg/kg	0.050	0.25	0.18	-
	Chromium	mg/kg	1.0	44	32	32
	Chromium (hexavalent)	mg/kg	0.080	<0.080	<0.080	-
	Cobalt	mg/kg	0.50	9.4	5.6	51
	Copper	mg/kg	1.0	20	17	16
	Lead	mg/kg	0.50	15	18	18
	Mercury	mg/kg	0.050	<0.050	<0.050	-
	Molybdenum	mg/kg	0.40	1.3	1.3	-
	Nickel	mg/kg	1.0	34	21	47
	Selenium	mg/kg	0.50	<0.50	<0.50	-
	Silver	mg/kg	0.20	<0.20	<0.20	-
	Thallium	mg/kg	0.10	0.16	<0.10	-
	Tin	mg/kg	1.0	<1.0	<1.0	-
Uranium	mg/kg	0.20	0.74	0.51	-	
Vanadium	mg/kg	1.0	34	19	57	
Zinc	mg/kg	10	92	81	13	
Petroleum Hydrocarbons	Benzene	mg/kg	0.0050	<0.0050	<0.0050	-
	Toluene	mg/kg	0.050	<0.050	<0.050	-
	Ethylbenzene	mg/kg	0.010	<0.010	<0.010	-
	Total Xylenes	mg/kg	0.045	<0.045	<0.045	-
	F1-BTEX	mg/kg	10	<10	<10	-
	Fraction 2 (C11-C16)	mg/kg	10	<10	<10	-
	Fraction 3 (C16-C34)	mg/kg	50	82	62	-
	Fraction 4 (C34-C50)	mg/kg	50	58	<50	-
Non-Carcinogenic PAH	Acenaphthene	mg/kg	0.0050	<0.0050	<0.0050	-
	Acenaphthylene	mg/kg	0.0050	<0.0050	<0.0050	-
	Anthracene	mg/kg	0.0040	<0.0040	<0.0040	-
	Fluoranthene	mg/kg	0.0050	<0.0050	<0.0050	-
	Fluorene	mg/kg	0.0050	<0.0050	<0.0050	-
	Naphthalene	mg/kg	0.0050	<0.0050	<0.0050	-
	Phenanthrene	mg/kg	0.0050	<0.0050	<0.0050	-
	Pyrene	mg/kg	0.0050	0.0062	<0.0050	-
Carcinogenic PAH	Benzo(a)anthracene	mg/kg	0.0050	<0.0050	<0.0050	-
	Benzo(a)pyrene	mg/kg	0.0050	<0.0050	<0.0050	-
	Benzo(b+j)fluoranthene	mg/kg	0.0050	0.0065	<0.0050	-
	Benzo(g,h,i)perylene	mg/kg	0.0050	0.0080	<0.0050	-
	Benzo(k)fluoranthene	mg/kg	0.0050	<0.0050	<0.0050	-
	Chrysene	mg/kg	0.0050	<0.0050	<0.0050	-
	Dibenzo(a,h)anthracene	mg/kg	0.0050	<0.0050	<0.0050	-
	Indeno(1,2,3-c,d)pyrene	mg/kg	0.0050	<0.0050	<0.0050	-

Notes:

- Not analyzed / Result not 5x more than LDL

Shading indicates RPD values greater than 50%

LDL - Lowest Detection Limit

* Individual analyte detection limit reported to be greater than overall LD

APPENDIX G - DRAFT PRELIMINARY DESIGN DRAWINGS



INTEGRATED INFRASTRUCTURE SERVICES INFRASTRUCTURE DELIVERY BRANCH

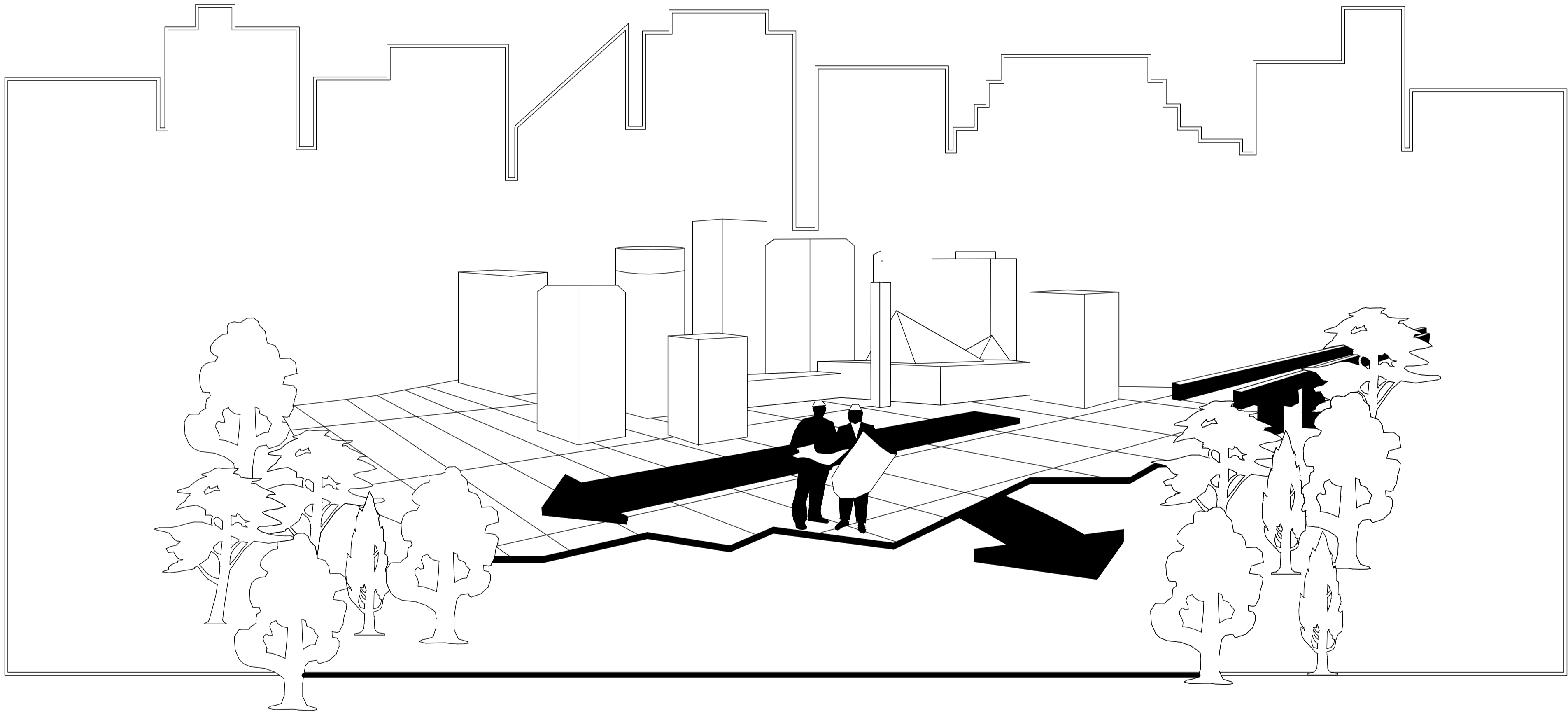

TERWILLIGER DRIVE EXPANSION - STAGE 2

ISSUED FOR PRELIMINARY DESIGN

DRAWING WHIT-P211-001

DRAWING INDEX

TERWILLIGER DRIVE EXPANSION - STAGE 2

PROJECT NAME

LOCATION

NO.	DRAWING TITLE
GENERAL	
WHIT-P211-001	COVER SHEET
WHIT-P211-002	DRAWING INDEX
RAINBOW VALLEY BRIDGES REHABILITATION AND WIDENING	
WHIT-P211-S01	GENERAL ARRANGEMENT
WHIT-P211-S02	PIER SECTION
WHIT-P211-S03	ABUTMENT SECTIONS
WHIT-P211-S04	ABUTMENTS DETAILS
WHIT-P211-S05	DECK SECTIONS
WHIT-P211-S06	CONSTRUCTION LAYDOWN
RAINBOW VALLEY PEDESTRIAN BRIDGE	
WHIT-P212-S01	STRAIGHT TRAPEZOIDAL STEEL GIRDER
WHIT-P212-S02	STRAIGHT TRAPEZOIDAL STEEL GIRDER DETAILS
WHIT-P212-S03	STRAIGHT TRAPEZOIDAL STEEL GIRDER RENDERING
TERWILLIGER DRIVE INTERCHANGE UPDATES	
TERW-P211-S01	GENERAL LAYOUT - PHASE 1
TERW-P212-S01	PHASE 1 RETAINING WALL
SOUTHBOUND BUS-ONLY RAMP RETAINING WALL	
WHIT-P213-S01	GENERAL LAYOUT - BUS RAMP RETAINING WALL
WHIT-P213-S02	BUS RAMP RETAINING WALL

DRAWING

WHIT-P211-002

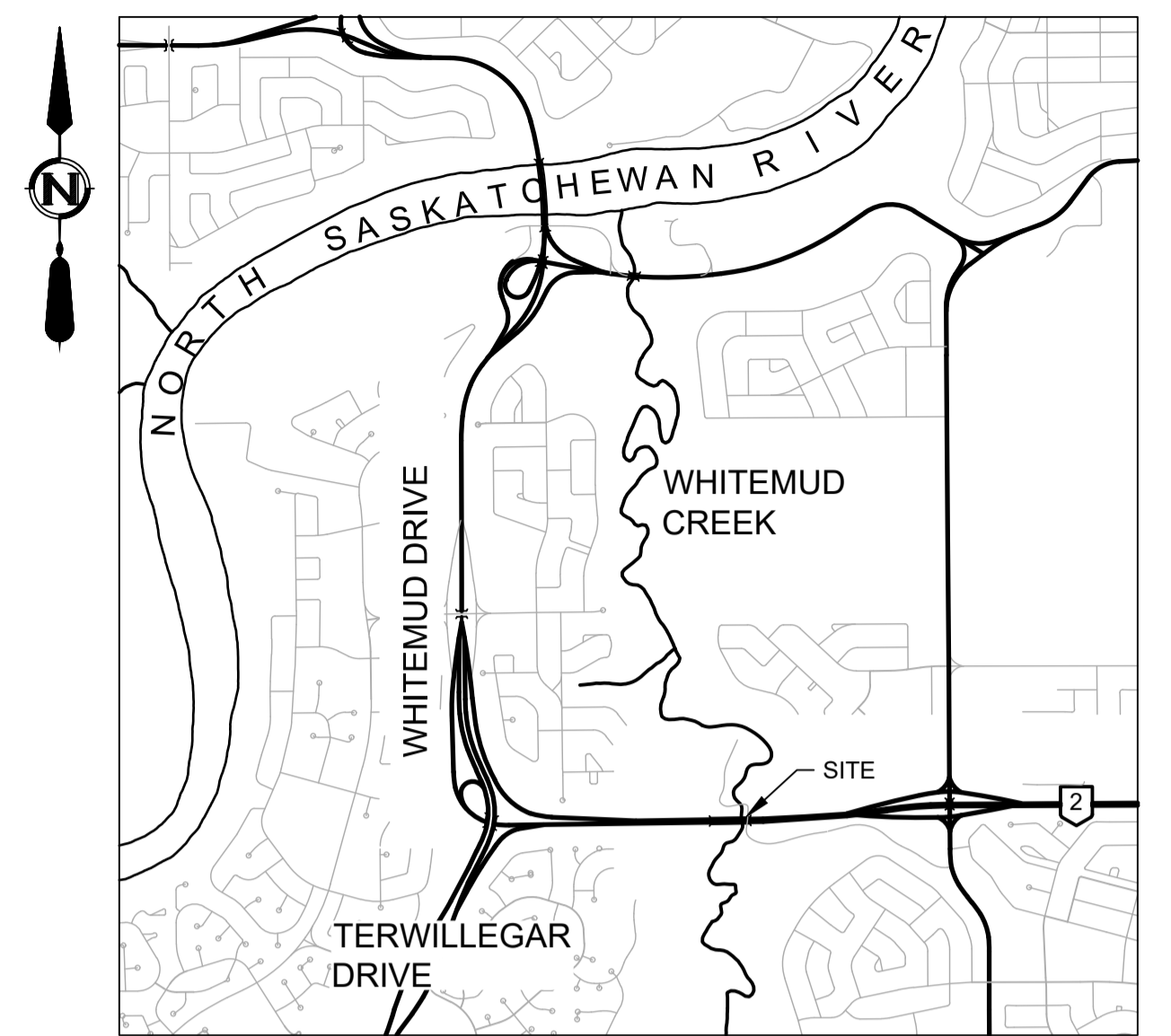
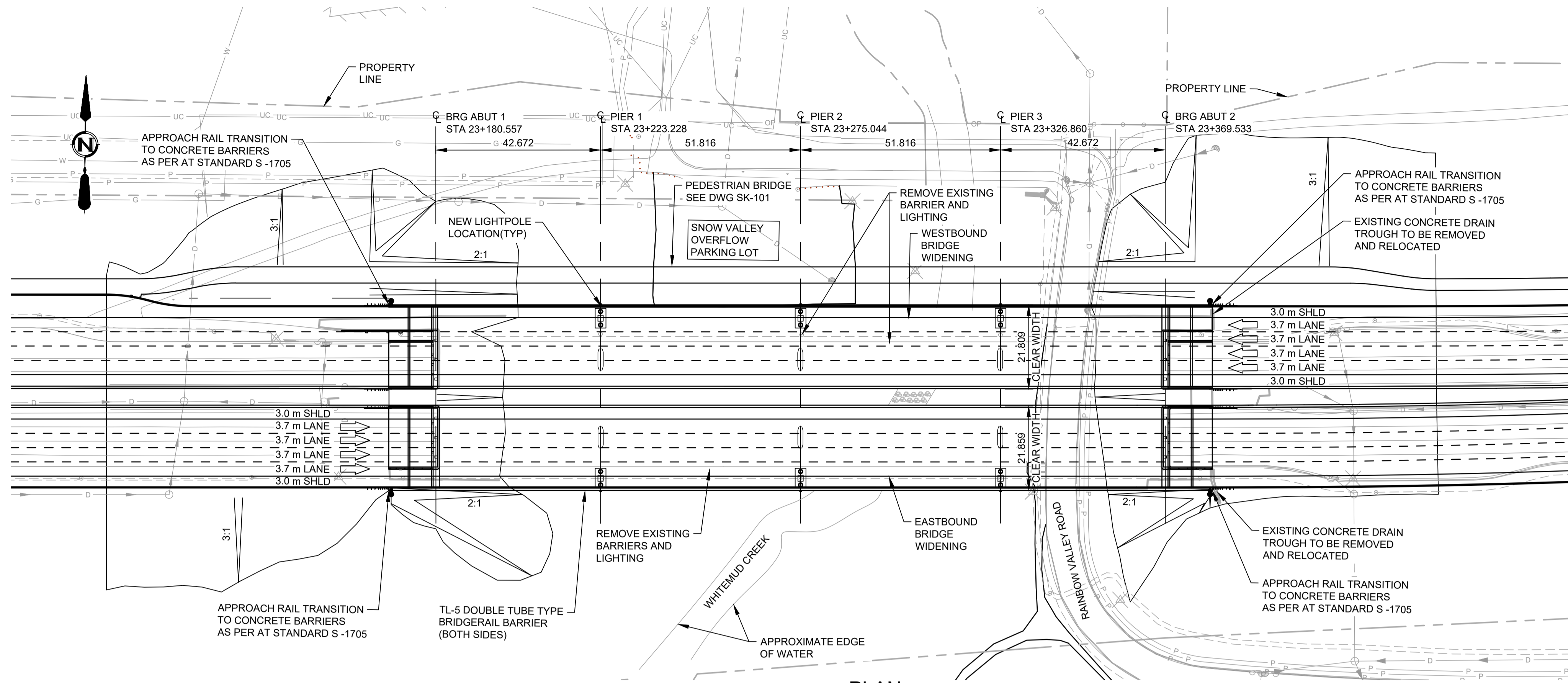

SITE PLAN

UTILITY LEGEND

- CATCH BASIN MANHOLE
- CATCH BASIN
- DRAINAGE MANHOLE (SANITARY)
- DRAINAGE MANHOLE (STORM)
- STREET LIGHT
- STREET LIGHT
- EXISTING SANITARY DRAINAGE
- EXISTING OVERHEAD POWER
- EXISTING UNDERGROUND POWER
- EXISTING STREETLIGHT POWER
- EXISTING ATCO GAS LINE
- EXISTING TELUS UNDERGROUND
- EXISTING STORM DRAINAGE
- SS
- OP
- P
- G
- UC
- W

PLAN 1:750

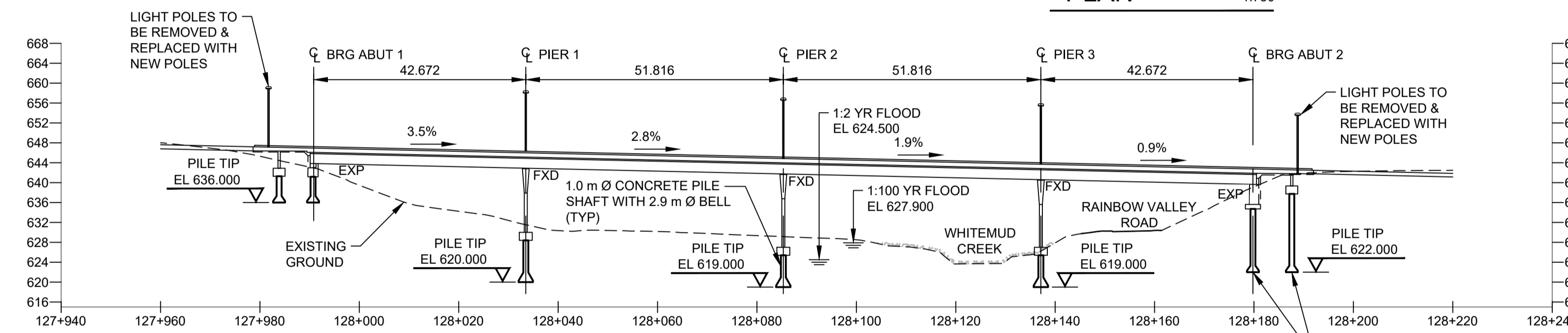

ELEVATION 1:750
WHITEMUD DRIVE WB

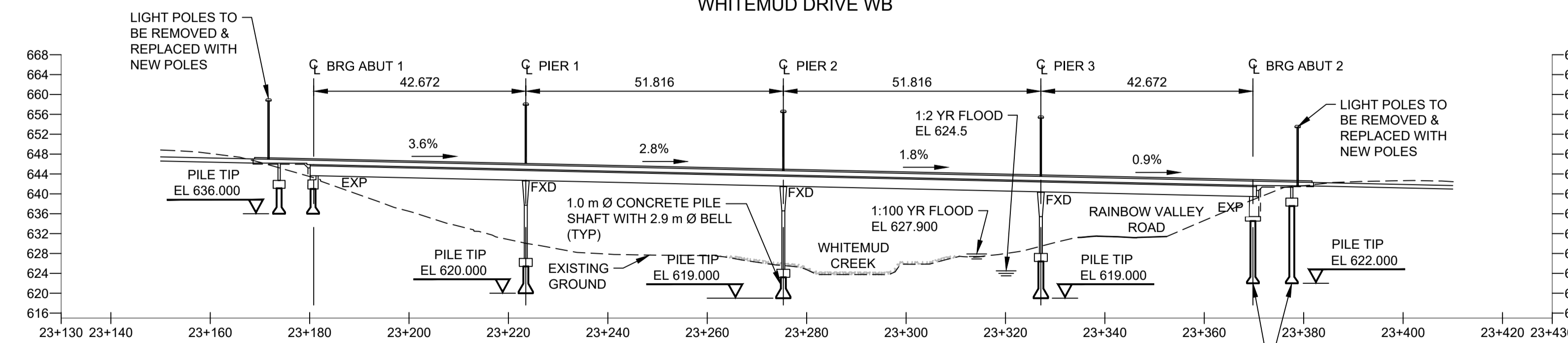

ELEVATION 1:750
WHITEMUD DRIVE EB

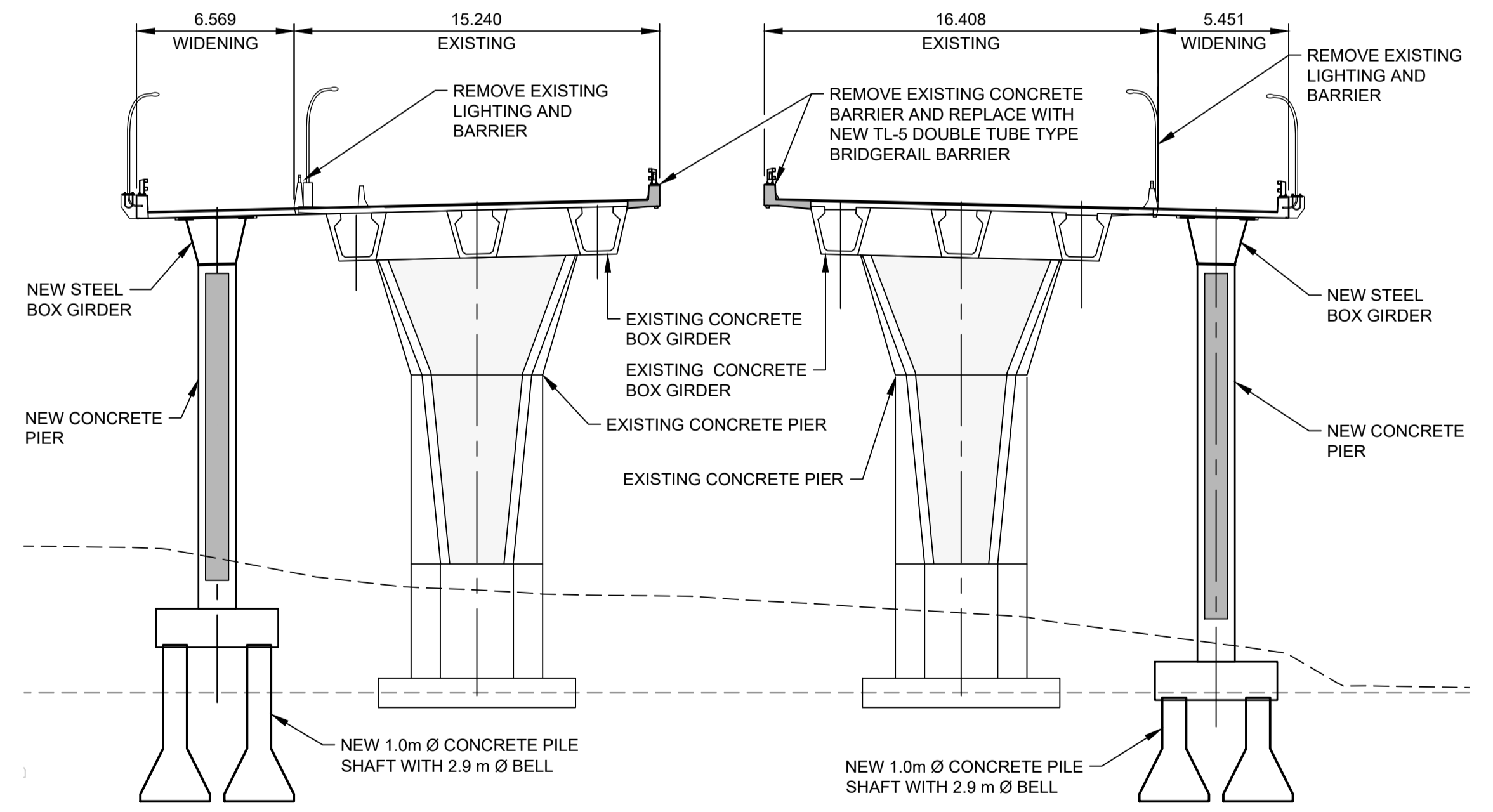

SECTION 1:200
TYPICAL PIER SECTION

**PRELIMINARY DESIGN
NOT FOR CONSTRUCTION**

NO.	REVISIONS	BY	DATE	APPD
7				
6				
5				
4				
3				
2				
1				

PROGRAM NO.			
CONTRACT NO.			
AS BUILT / TO GBS			
TENDER AWARD DATE			
NO.	ISSUE	BY	DATE

CONSTRUCTION RETURN	DESIGN CONSULTANT
CONTRACTOR	
SURVEYOR	
DATE	
FILE NUMBER	
CONSTRUCTION ENGINEER	DATE
GENERAL SUPERVISOR	DATE

PERMIT TO PRACTICE
ASSOCIATED ENGINEERING ALBERTA LTD.

Signature: *[Signature]*
2021-09-23

PERMIT NUMBER: P 03979
The Association of Professional Engineers and Geoscientists of Alberta

APPROVED FOR CONSTRUCTION



TRANSPORTATION PLANNING AND DESIGN SUPERVISOR	APPROVAL	DATE
TRANSPORTATION INFRASTRUCTURE DELIVERY SUPERVISOR		
DEPARTMENT / BRANCH		

DIRECTOR OF TRANSPORTATION PLANNING AND DESIGN	DATE
	MM/DD/YY
SURVEY	DATE
JOB NO.	
SCALE	
SCALES SHOWN ARE CORRECT FOR FULL SIZE PLOTS (A1 SHEET SIZE)	
CHECKED	DATE
K. HABEL	JUN 2021

Edmonton INTEGRATED INFRASTRUCTURE SERVICES
INFRASTRUCTURE PLANNING AND DESIGN BRANCH

PROJECT: **TERWILLEGAR DRIVE EXPANSION - STAGE 2**
PRELIMINARY DESIGN
GENERAL LAYOUT

DRAWING: **WHIT-P211-S01**

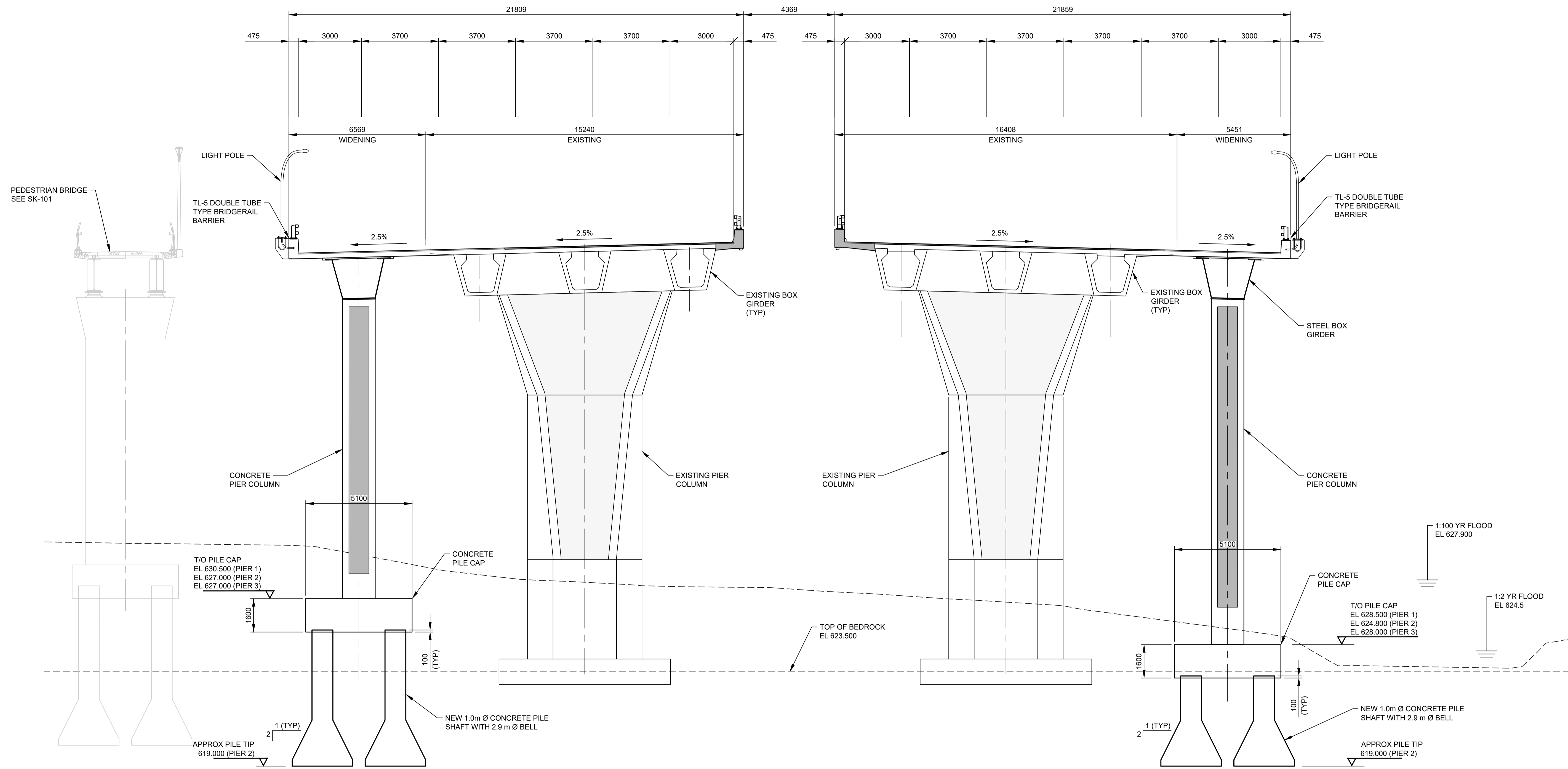

ELEVATION 1:100
PIER 2 LOOKING EAST

NOTES

- DIMENSIONS ARE GIVEN IN MILLIMETERS UNLESS NOTED OTHERWISE
- ELEVATIONS ARE GIVEN IN METERS UNLESS NOTED OTHERWISE

**PRELIMINARY DESIGN
NOT FOR CONSTRUCTION**

NO.	REVISIONS	BY	DATE	APPD
7				
6				
5				
4				
3				
2				
1				

PROGRAM NO.			
CONTRACT NO.			
AS BUILT / TO GBS			
TENDER AWARD DATE			
NO.	ISSUE	BY	DATE

CONSTRUCTION RETURN	
CONTRACTOR	
SURVEYOR	
DATE	
FILE NUMBER	
CONSTRUCTION ENGINEER	DATE
GENERAL SUPERVISOR	DATE

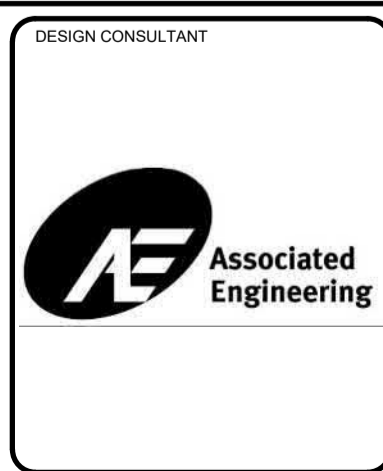

PERMIT TO PRACTICE
ASSOCIATED ENGINEERING ALBERTA LTD.
Signature: *[Signature]*
2021-09-23
PERMIT NUMBER: P 03979
The Association of Professional Engineers and Geoscientists of Alberta
APPROVED FOR CONSTRUCTION



TRANSPORTATION PLANNING AND DESIGN SUPERVISOR	
TRANSPORTATION INFRASTRUCTURE DELIVERY SUPERVISOR	
DEPARTMENT / BRANCH	APPROVAL
	DATE

DIRECTOR OF TRANSPORTATION PLANNING AND DESIGN	DATE
	MM/DD/YY
SURVEY	
JOB NO.	
SCALE	
SCALES SHOWN ARE CORRECT FOR FULL SIZE PLOTS (A1 SHEET SIZE)	
DRAWN	DATE
M. CHELINI	JUN 2021
DESIGNED	DATE
L. ARASARATNAM	JUN 2021
CHECKED	DATE
K. HABEL	JUN 2021

Edmonton INTEGRATED INFRASTRUCTURE SERVICES
INFRASTRUCTURE PLANNING AND DESIGN BRANCH

PROJECT: **TERWILLEGAR DRIVE EXPANSION - STAGE 2**
PRELIMINARY DESIGN
PIER SECTION

DRAWING: **WHIT-P211-S02**

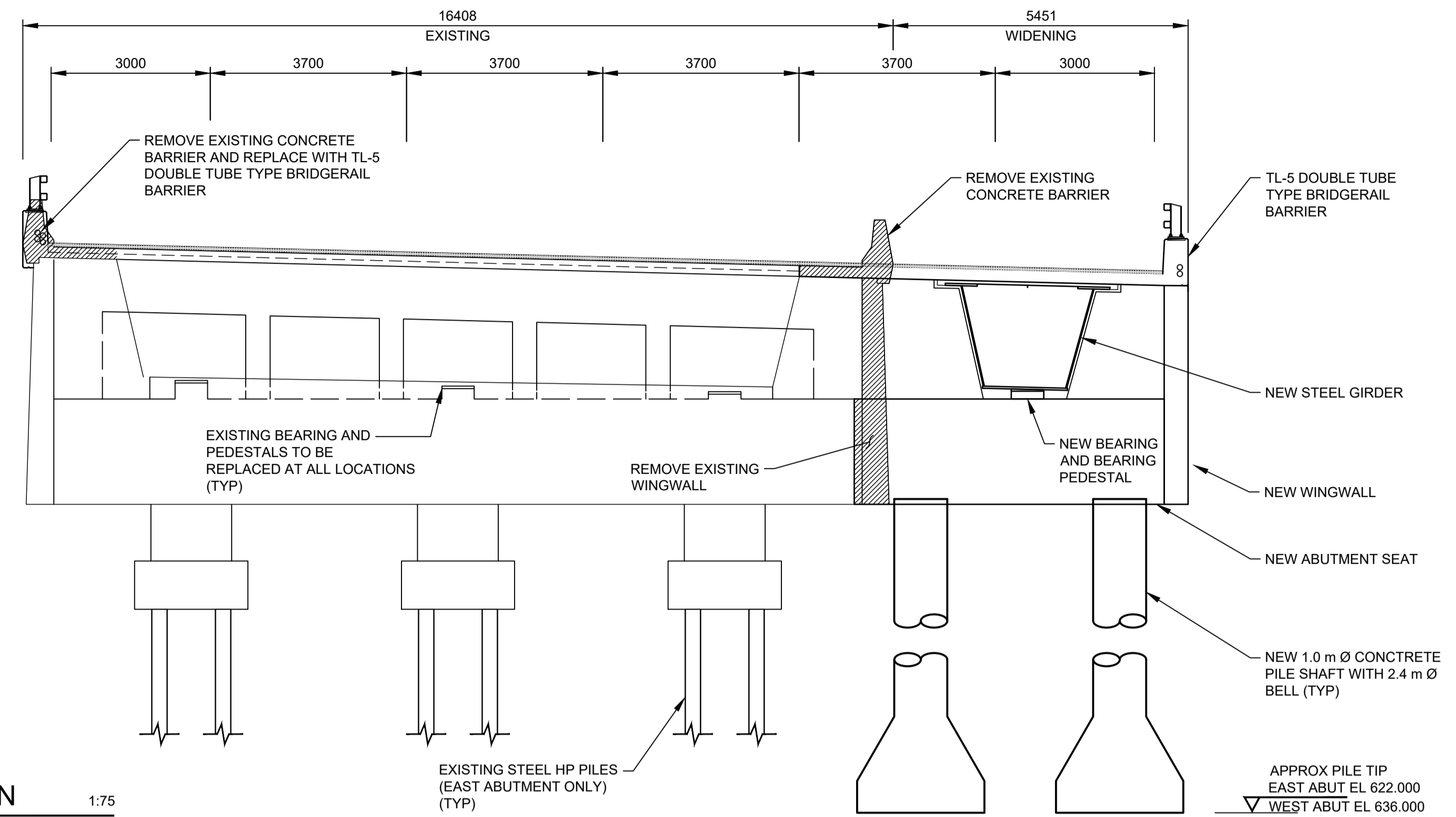
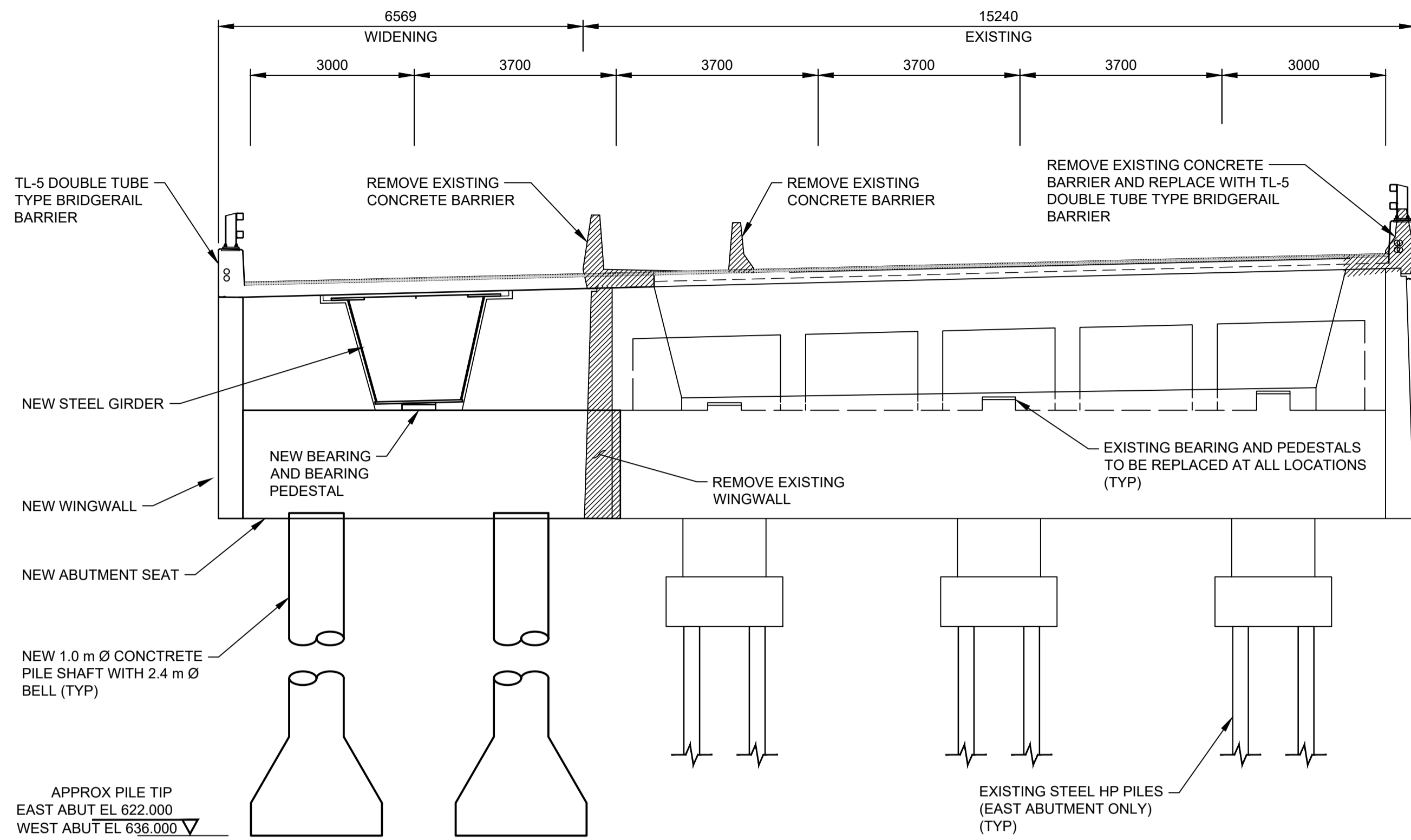

SECTION 1:75
EAST ABUTMENT SHOWN
(WEST ABUTMENT SIMILAR)

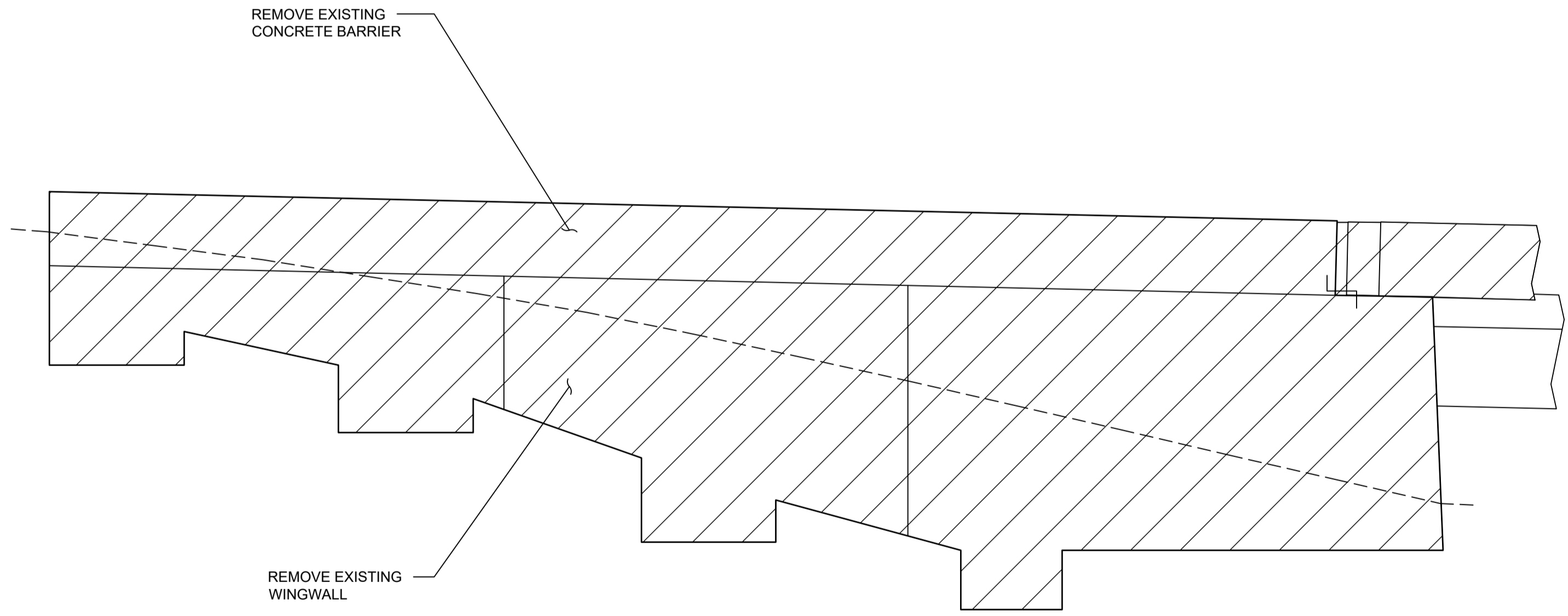

ELEVATION 1:75
WB ABUT 1 NORTH FACE DEMOLITION
LOOKING SOUTH

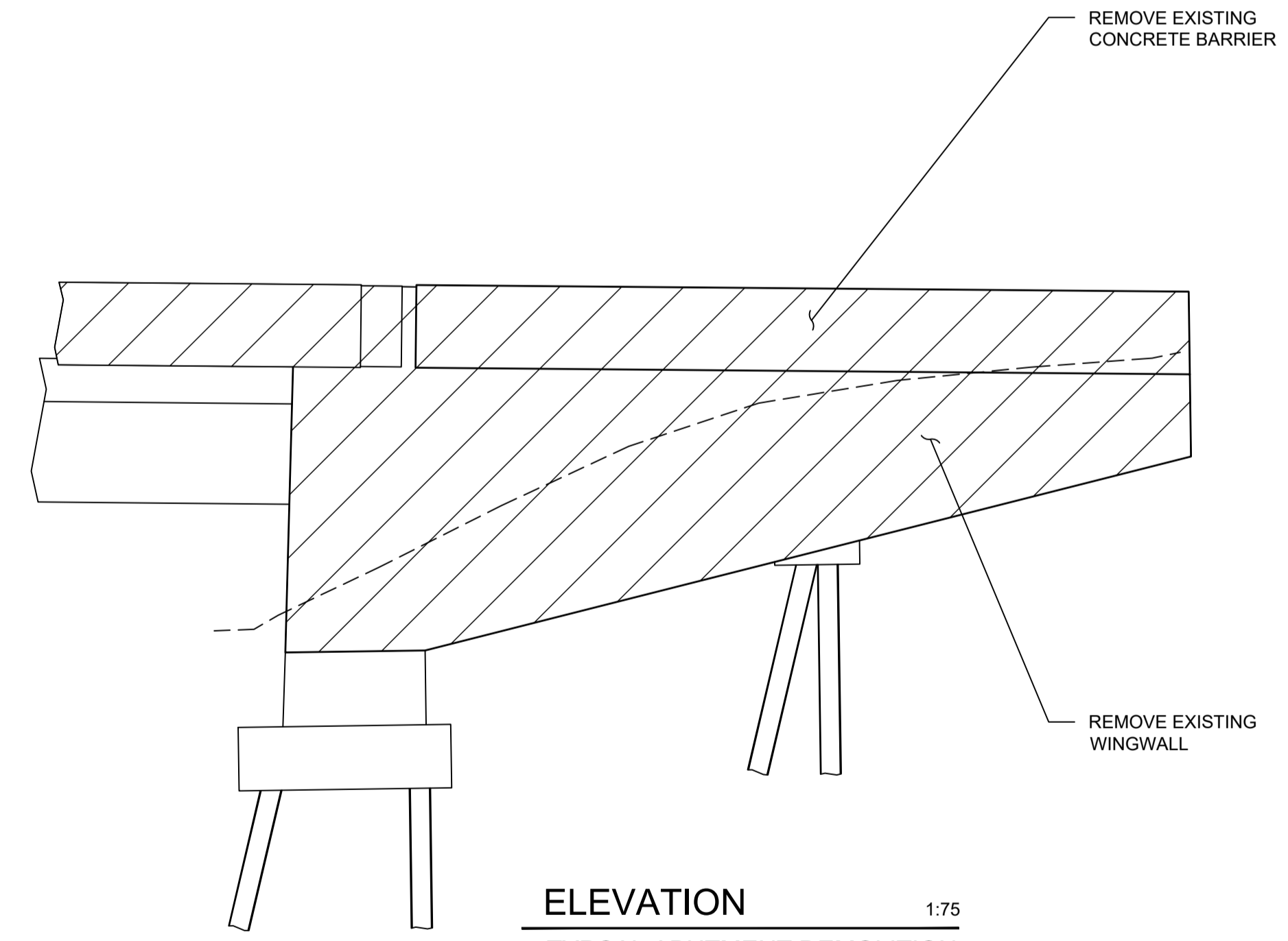

ELEVATION 1:75
TYPICAL ABUTMENT DEMOLITION

NOTES

- DIMENSIONS ARE GIVEN IN MILLIMETERS UNLESS NOTED OTHERWISE
- ELEVATIONS ARE GIVEN IN METERS UNLESS NOTED OTHERWISE

**PRELIMINARY DESIGN
NOT FOR CONSTRUCTION**

NO.	REVISIONS	BY	DATE	APPD
7				
6				
5				
4				
3				
2				
1				

PROGRAM NO.			
CONTRACT NO.			
AS BUILT / TO GBS			
TENDER AWARD DATE			
NO.	ISSUE	BY	DATE

CONTRACTOR	
SURVEYOR	
DATE	
FILE NUMBER	
CONSTRUCTION ENGINEER	DATE
GENERAL SUPERVISOR	DATE

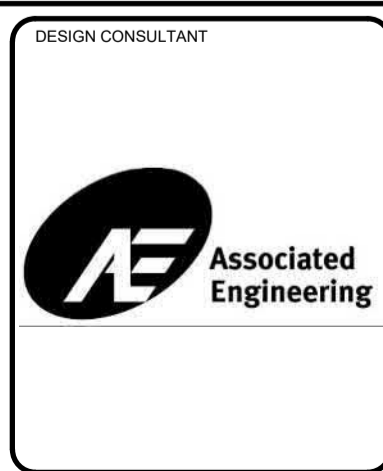

PERMIT TO PRACTICE
ASSOCIATED ENGINEERING ALBERTA LTD.
Signature: *[Signature]*
2021-09-23
PERMIT NUMBER: P 03979
The Association of Professional Engineers and Geoscientists of Alberta
APPROVED FOR CONSTRUCTION



TRANSPORTATION PLANNING AND DESIGN SUPERVISOR		
TRANSPORTATION INFRASTRUCTURE DELIVERY SUPERVISOR		
DEPARTMENT / BRANCH	APPROVAL	DATE

DIRECTOR OF TRANSPORTATION PLANNING AND DESIGN	DATE
	MM/DD/YY
SURVEY	
JOB NO.	
SCALE	
SCALES SHOWN ARE CORRECT FOR FULL SIZE PLOTS (A1 SHEET SIZE)	
DRAWN	DATE
M. CHELINI	JUN 2021
DESIGNED	DATE
L. ARASARATNAM	JUN 2021
CHECKED	DATE
K. HABEL	JUN 2021

Edmonton INTEGRATED INFRASTRUCTURE SERVICES
INFRASTRUCTURE PLANNING AND DESIGN BRANCH

PROJECT: **TERWILLEGAR DRIVE EXPANSION - STAGE 2**
PRELIMINARY DESIGN
ABUTMENT SECTIONS

DRAWING: **WHIT-P211-S03**

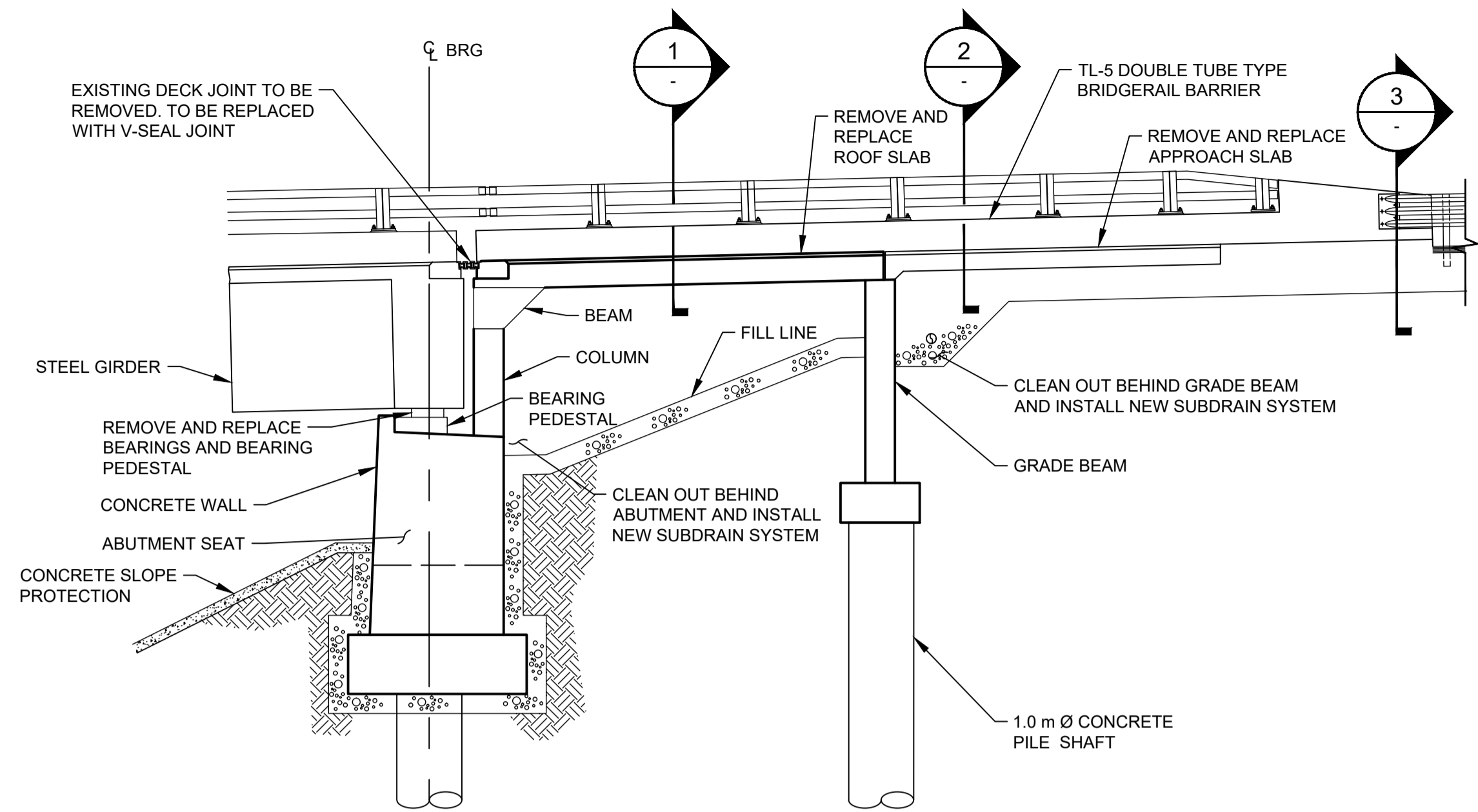

SECTION 1:75
AT EXISTING BRIDGE ABUTMENTS

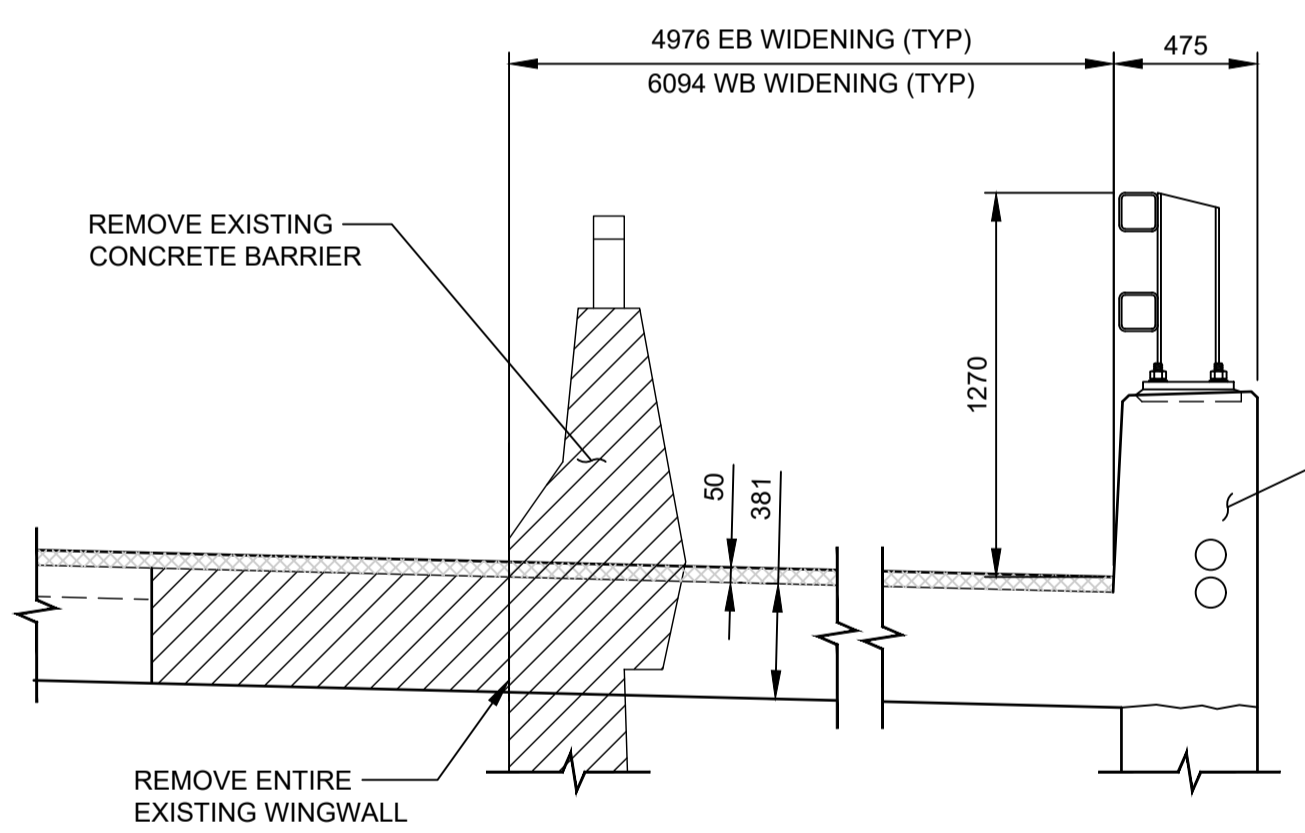

1 SECTION 1:25

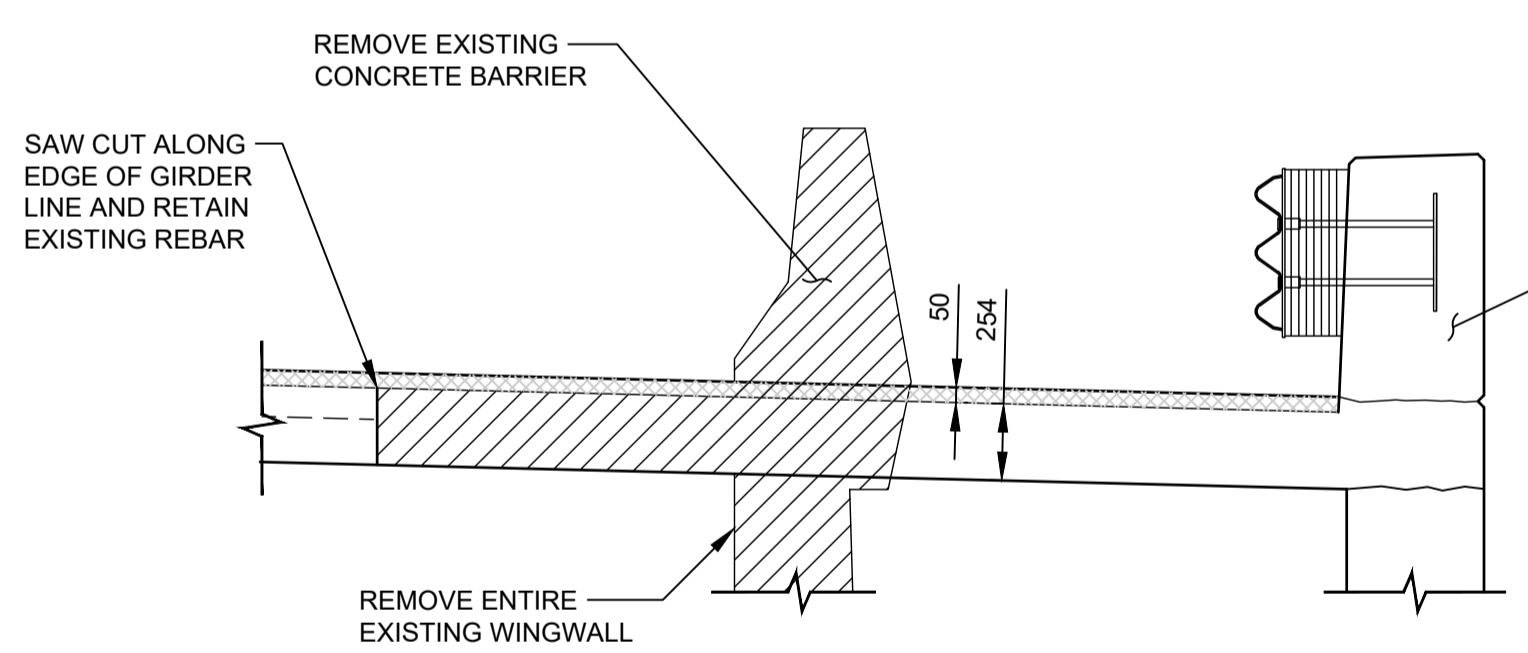

2 SECTION 1:25

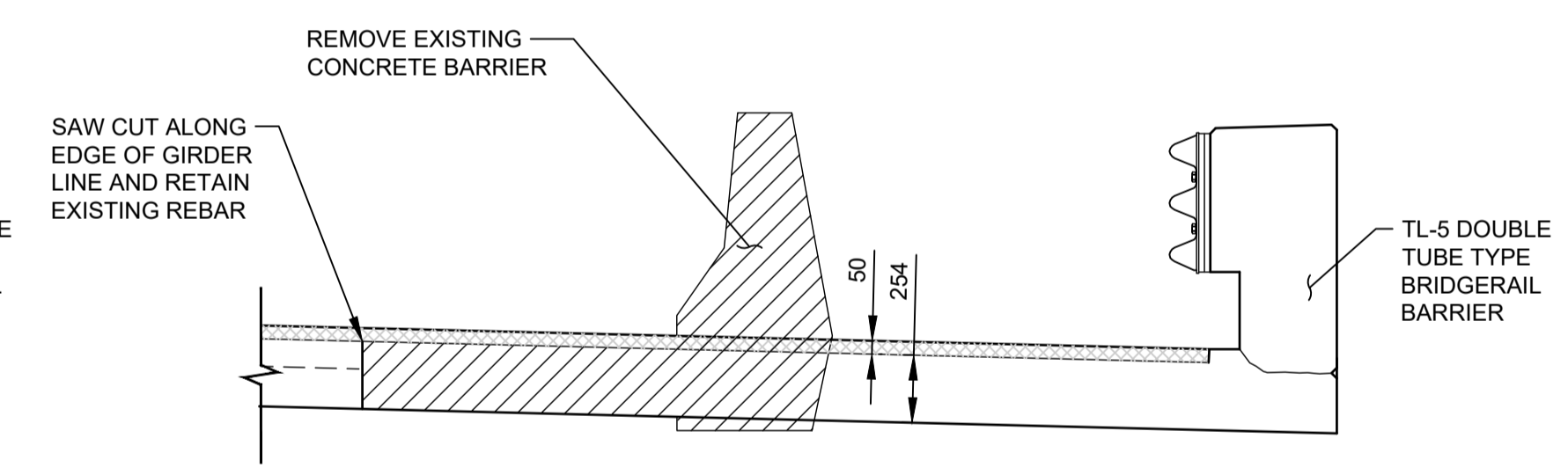

3 SECTION 1:25

**PRELIMINARY DESIGN
NOT FOR CONSTRUCTION**

7					
6					
5					
4					
3					
2					
1					
NO.	REVISIONS	BY	DATE	APPD	

PROGRAM NO.			
CONTRACT NO.			
AS BUILT / TO GBS			
TENDER AWARD DATE			
NO.	ISSUE	BY	DATE

CONTRACTOR	
SURVEYOR	
DATE	
FILE NUMBER	
CONSTRUCTION ENGINEER	
DATE	
GENERAL SUPERVISOR	
DATE	

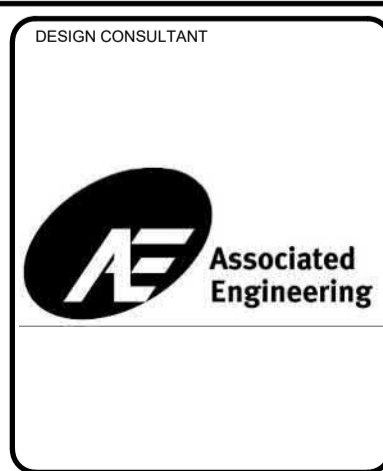

PERMIT TO PRACTICE
ASSOCIATED ENGINEERING ALBERTA LTD.
Signature: *[Signature]*
2021-09-23
PERMIT NUMBER: P 03979
The Association of Professional Engineers and Geoscientists of Alberta
APPROVED FOR CONSTRUCTION



TRANSPORTATION PLANNING AND DESIGN SUPERVISOR	
TRANSPORTATION INFRASTRUCTURE DELIVERY SUPERVISOR	
DEPARTMENT / BRANCH	
APPROVAL	
DATE	

DIRECTOR OF TRANSPORTATION PLANNING AND DESIGN		DATE	
		MM/DD/YYYY	
SURVEY		DATE	
JOB NO.		DATE	
SCALE		DATE	
SCALES SHOWN ARE CORRECT FOR FULL SIZE PLOTS (A1 SHEET SIZE)			
CHECKED		DATE	
K. HABEL		JUN 2021	

Edmonton INTEGRATED INFRASTRUCTURE SERVICES
INFRASTRUCTURE PLANNING AND DESIGN BRANCH

PROJECT: **TERWILLEGAR DRIVE EXPANSION - STAGE 2**
PRELIMINARY DESIGN
ABUTMENT DETAILS

DRAWING: **WHIT-P211-S04**

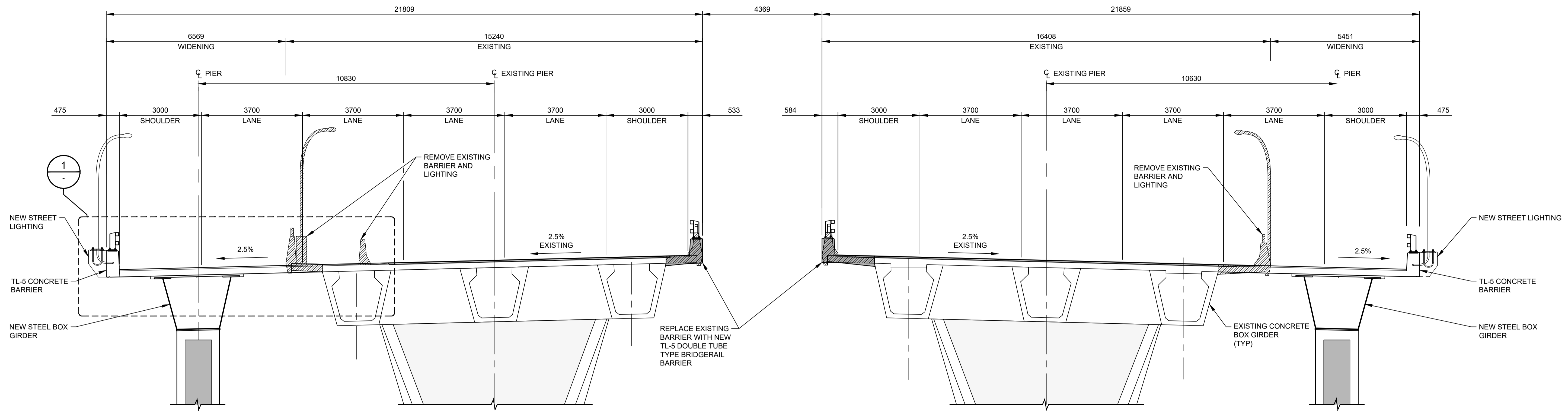

TYPICAL SECTION 1:75
WESTBOUND (LOOKING EAST)

TYPICAL SECTION 1:75
EASTBOUND (LOOKING EAST)

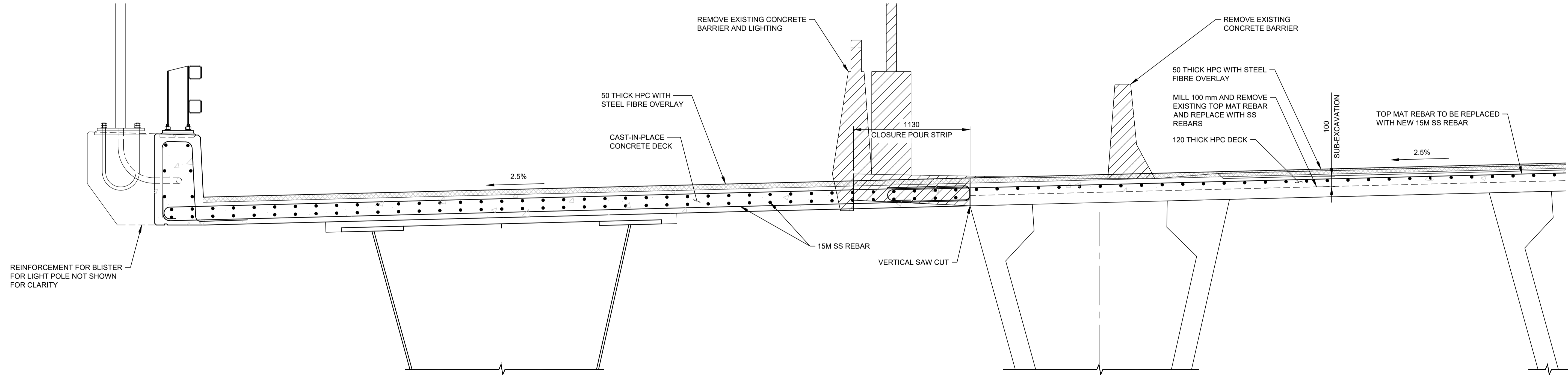

1 DETAIL 1:20
EASTBOUND (LOOKING EAST)

**PRELIMINARY DESIGN
NOT FOR CONSTRUCTION**

7					
6					
5					
4					
3					
2					
1					
NO.	REVISIONS	BY	DATE	APPD	

PROGRAM NO.			
CONTRACT NO.			
AS BUILT / TO GBS			
TENDER AWARD DATE			
NO.	ISSUE	BY	DATE

CONSTRUCTION RETURN	
CONTRACTOR	
SURVEYOR	
DATE	
FILE NUMBER	
CONSTRUCTION ENGINEER	DATE
GENERAL SUPERVISOR	DATE

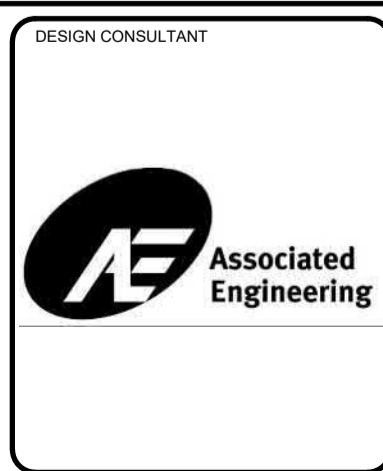

PERMIT TO PRACTICE
ASSOCIATED ENGINEERING ALBERTA LTD.
Signature: *[Signature]* 2021-09-23
Permit No. P 03979
The Association of Professional Engineers and Geoscientists of Alberta
APPROVED FOR CONSTRUCTION



TRANSPORTATION PLANNING AND DESIGN SUPERVISOR	
TRANSPORTATION INFRASTRUCTURE DELIVERY SUPERVISOR	
DEPARTMENT / BRANCH	
APPROVAL	DATE

DIRECTOR OF TRANSPORTATION PLANNING AND DESIGN	DATE
	MM/DD/YY
SURVEY	
JOB NO.	
SCALE	
SCALES SHOWN ARE CORRECT FOR FULL SIZE PLOTS (A1 SHEET SIZE)	
DRAWN	DATE
M. CHELINI	JUN 2021
DESIGNED	DATE
L. ARASARATNAM	JUN 2021
CHECKED	DATE
K. HABEL	JUN 2021

Edmonton INTEGRATED INFRASTRUCTURE SERVICES
INFRASTRUCTURE PLANNING AND DESIGN BRANCH

PROJECT: **TERWILLEGAR DRIVE EXPANSION - STAGE 2**
PRELIMINARY DESIGN
DECK SECTIONS

DRAWING: **WHIT-P211-S05**

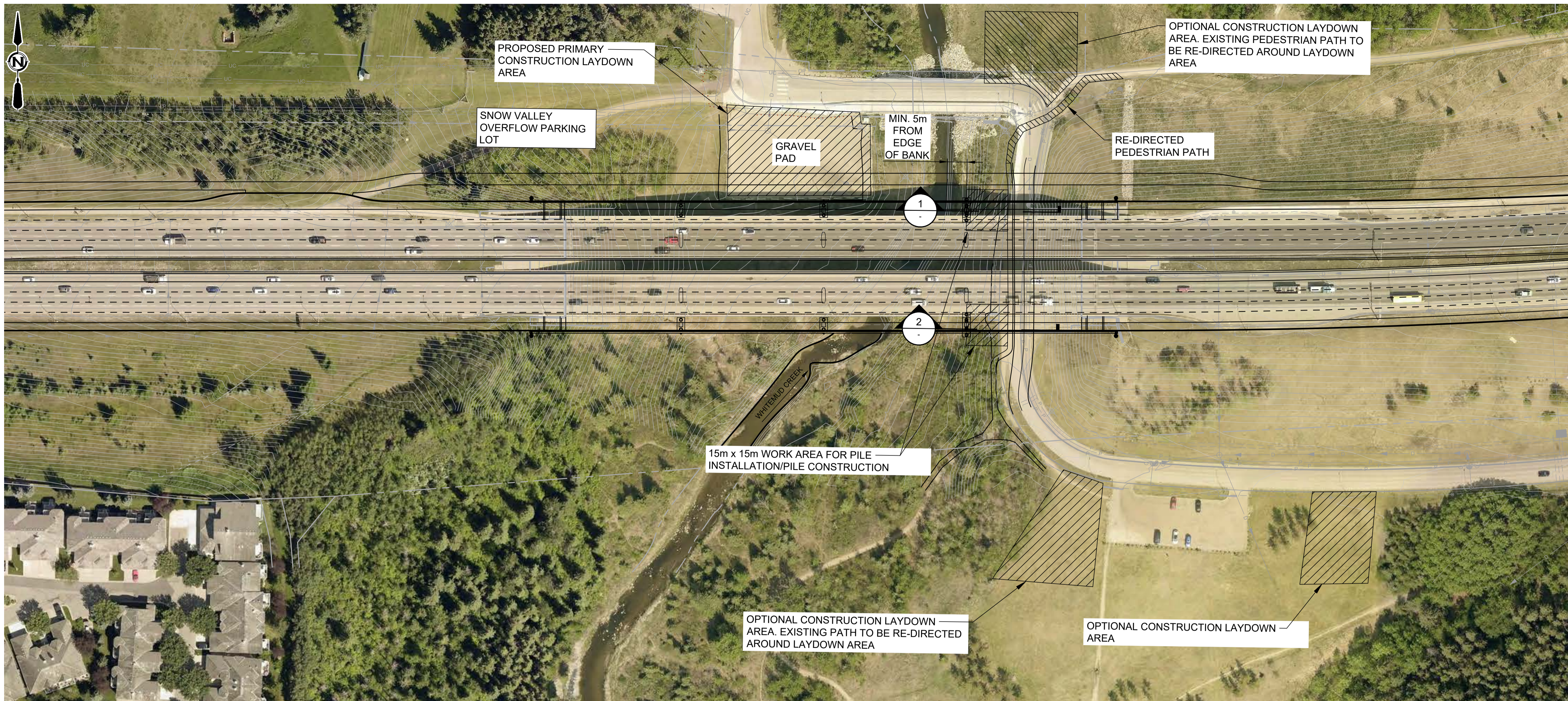

PLAN 1:750

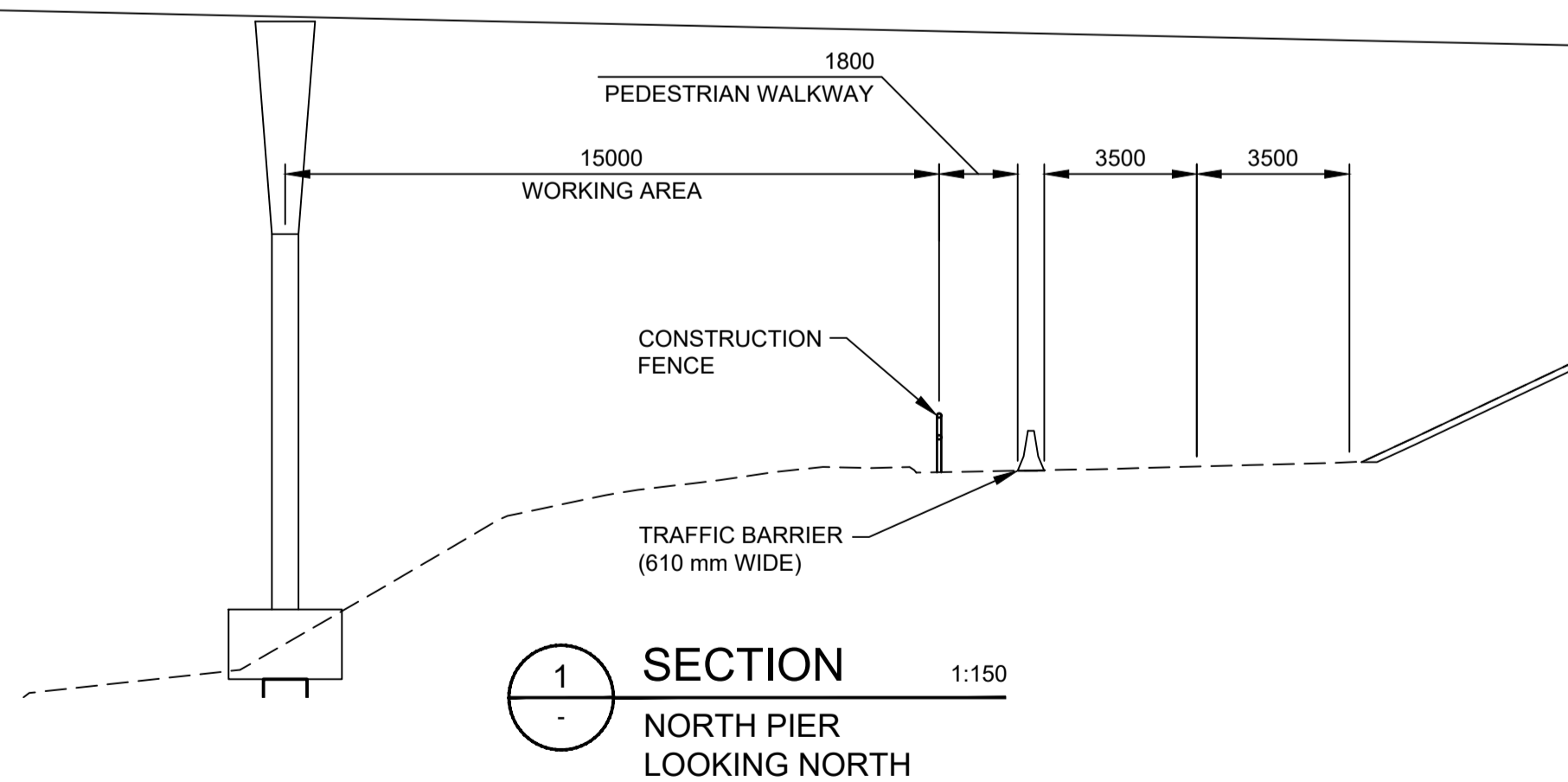

1 SECTION 1:150
NORTH PIER
LOOKING NORTH

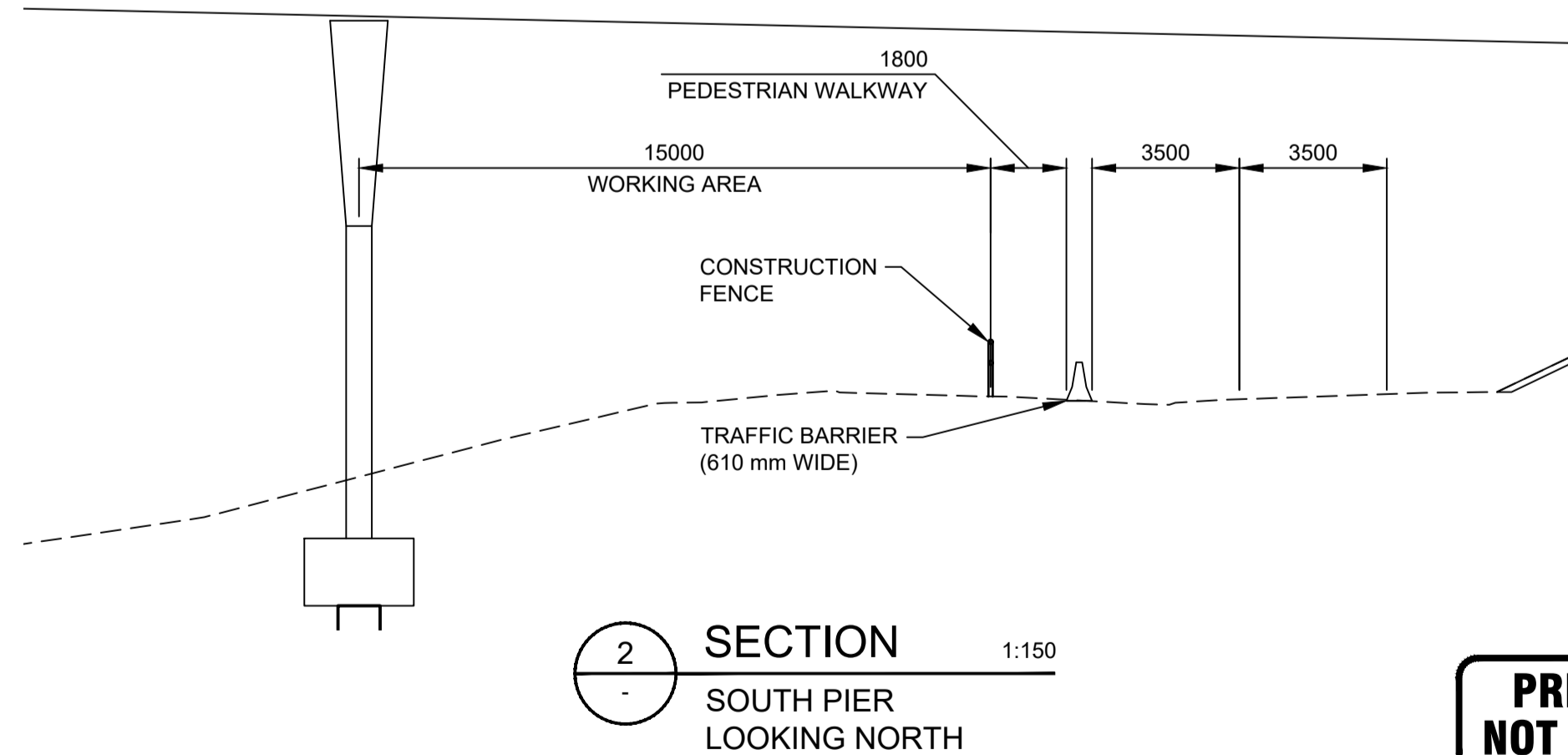

2 SECTION 1:150
SOUTH PIER
LOOKING NORTH

**PRELIMINARY DESIGN
NOT FOR CONSTRUCTION**

7					
6					
5					
4					
3					
2					
1					
NO.	REVISIONS	BY	DATE	APPD	

PROGRAM NO.			
CONTRACT NO.			
AS BUILT / TO GBS			
TENDER AWARD DATE			
NO.	ISSUE	BY	DATE

CONSTRUCTION RETURN	
CONTRACTOR	
SURVEYOR	
DATE	
FILE NUMBER	
CONSTRUCTION ENGINEER	
DATE	
GENERAL SUPERVISOR	
DATE	

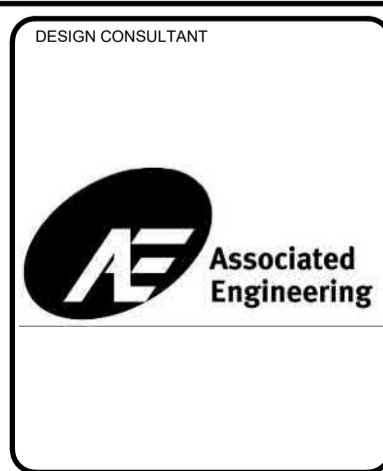

PERMIT TO PRACTICE
ASSOCIATED ENGINEERING ALBERTA LTD.
Signature: *[Signature]*
Member of Practice
Permit No. P 03979
2021-09-23
The Association of Professional Engineers and Geoscientists of Alberta
APPROVED FOR CONSTRUCTION



TRANSPORTATION PLANNING AND DESIGN SUPERVISOR	
TRANSPORTATION INFRASTRUCTURE DELIVERY SUPERVISOR	
DEPARTMENT / BRANCH	
APPROVAL	
DATE	

DIRECTOR OF TRANSPORTATION PLANNING AND DESIGN		DATE	
		MM/DD/YY	
SURVEY		DATE	
JOB NO.		DATE	
SCALE		DATE	
SCALES SHOWN ARE CORRECT FOR FULL SIZE PLOTS (A1 SHEET SIZE)			
CHECKED	T. ALEXANDER	DATE	JUN 2021

Edmonton INTEGRATED INFRASTRUCTURE SERVICES
INFRASTRUCTURE PLANNING AND DESIGN BRANCH

PROJECT: **TERWILLEGAR DRIVE EXPANSION - STAGE 2**
PRELIMINARY DESIGN
CONSTRUCTION LAYDOWN

DRAWING: **WHIT-P211-S06**

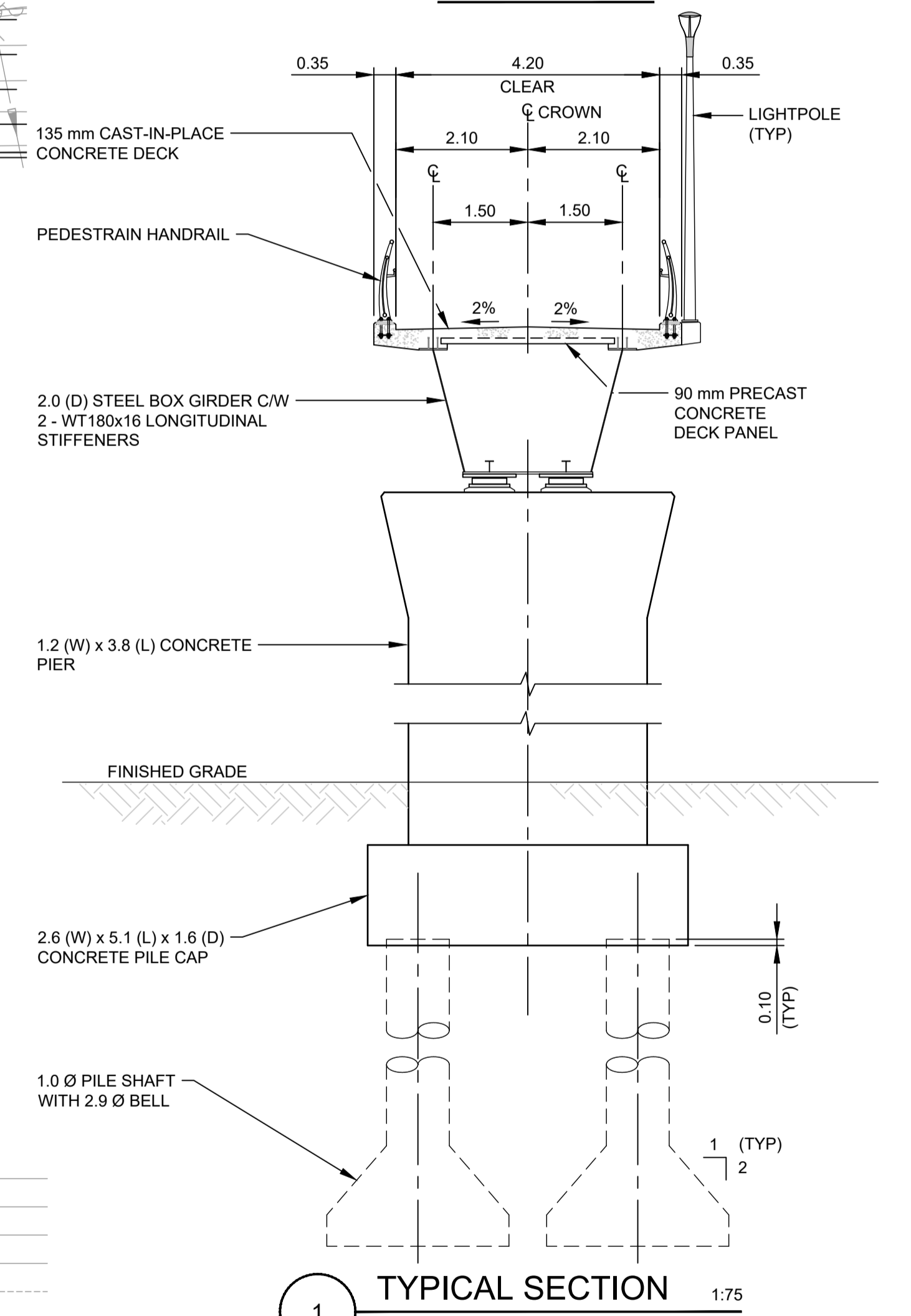
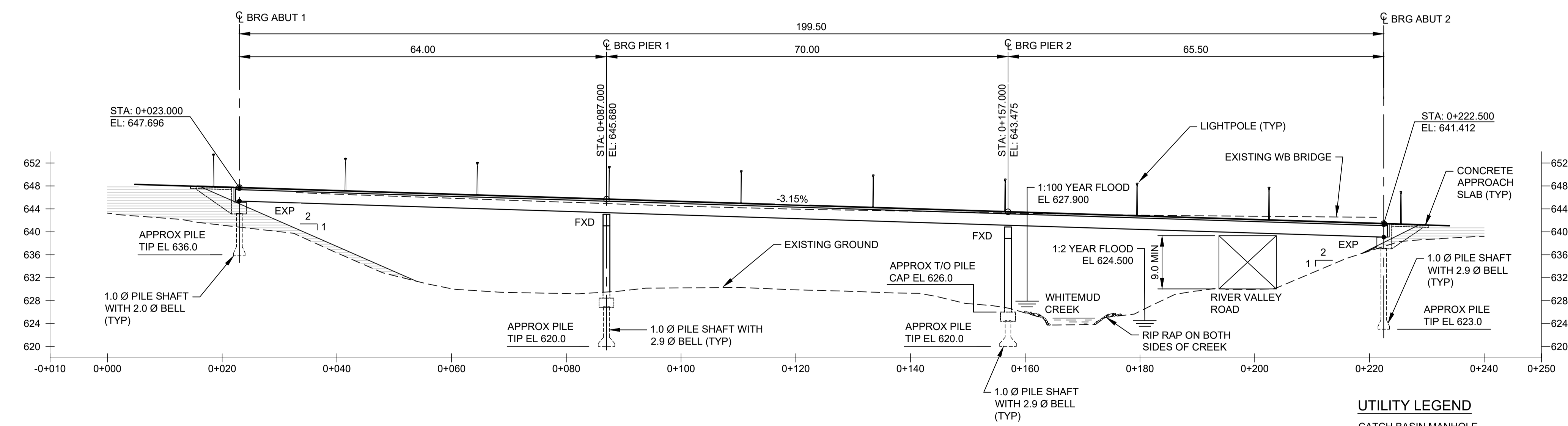
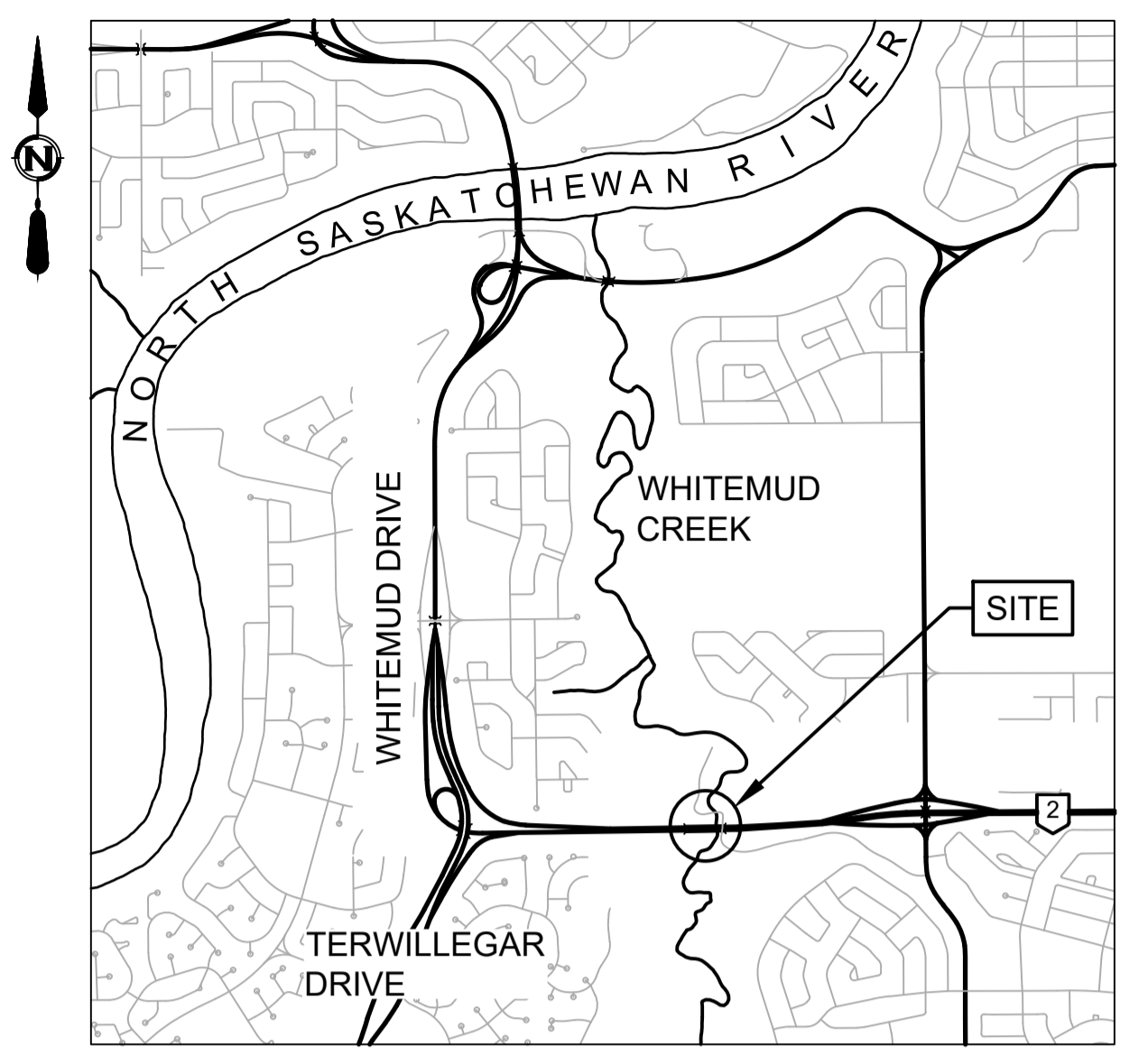
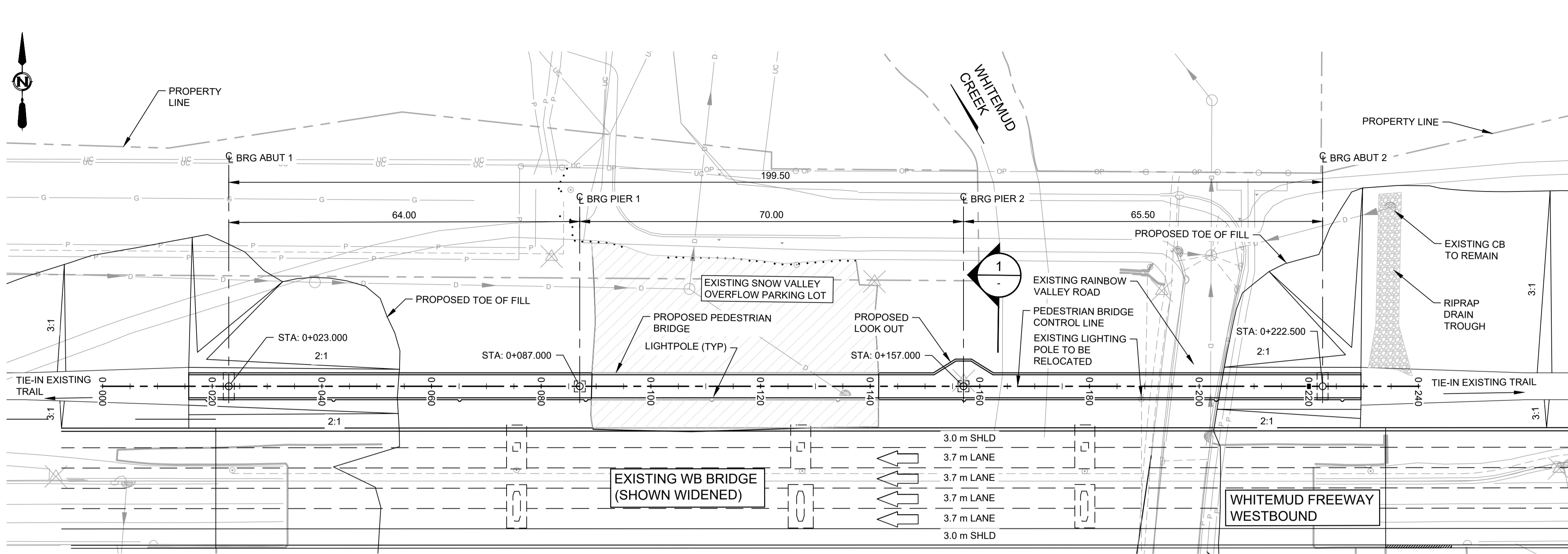

NOTES

- DIMENSIONS ARE GIVEN IN METERS UNLESS NOTED OTHERWISE
- DIMENSIONS ARE IN GROUND COORDINATES
- THE COORDINATES AND STATIONING ARE BASED ON NAD'83 DATUM USING THE 3TM GRID PROJECTION, CENTRAL MERIDIAN 114W. A COMBINED SCALE FACTOR (CSF) OF 0.999810571 HAS BEEN ADOPTED FOR THIS PROJECT
- ALL DIMENSIONS INDICATED ON THESE DRAWINGS ARE GROUND DISTANCES.
GRID DIMENSION = GROUND DIMENSION x CSF
GROUND DIMENSION = GRID DIMENSION / CSF

UTILITY LEGEND

	CATCH BASIN MANHOLE
	CATCH BASIN
	DRAINAGE MANHOLE (SANITARY)
	DRAINAGE MANHOLE (STORM)
	STREET LIGHT
	STREET LIGHT
	EXISTING STORM DRAINAGE
	EXISTING SANITARY DRAINAGE
	EXISTING OVERHEAD POWER
	EXISTING UNDERGROUND POWER
	EXISTING STREETLIGHT POWER
	EXISTING ATCO GAS LINE
	EXISTING TELUS UNDERGROUND
	EXISTING EPCOR WATER

**PRELIMINARY DESIGN
NOT FOR CONSTRUCTION**

7					
6					
5					
4					
3					
2					
1					
NO.	REVISIONS	BY	DATE	APPD	

PROGRAM NO.			
CONTRACT NO.			
AS BUILT / TO GBS			
TENDER AWARD DATE			
NO.	ISSUE	BY	DATE

CONSTRUCTION RETURN	
CONTRACTOR	
SURVEYOR	
DATE	
FILE NUMBER	
CONSTRUCTION ENGINEER	DATE
GENERAL SUPERVISOR	DATE

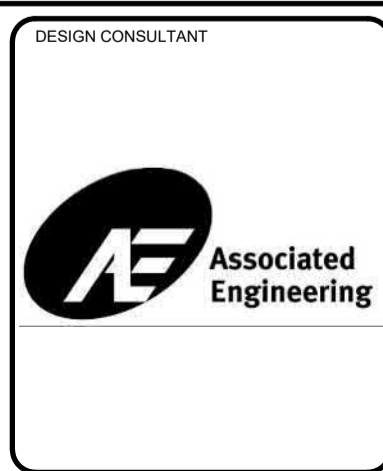

PERMIT TO PRACTICE
ASSOCIATED ENGINEERING ALBERTA LTD.
Signature: *[Signature]*
2021-09-23
PERMIT NUMBER: P 03979
The Association of Professional Engineers and Geoscientists of Alberta
APPROVED FOR CONSTRUCTION



TRANSPORTATION PLANNING AND DESIGN SUPERVISOR	
TRANSPORTATION INFRASTRUCTURE DELIVERY SUPERVISOR	
DEPARTMENT / BRANCH	
APPROVAL	DATE

DIRECTOR OF TRANSPORTATION PLANNING AND DESIGN	DATE
	MM/DD/YY
SURVEY	
JOB NO.	
SCALE	
SCALES SHOWN ARE CORRECT FOR FULL SIZE PLOTS (A1 SHEET SIZE)	
DRAWN	DATE
R. XU	JUN 2021
DESIGNED	DATE
L. ARASARATNAM	JUN 2021
CHECKED	DATE
M. PAULSEN	JUN 2021

Edmonton INTEGRATED INFRASTRUCTURE SERVICES
INFRASTRUCTURE PLANNING AND DESIGN BRANCH

PROJECT: **TERWILLEGAR DRIVE EXPANSION - STAGE 2**
PRELIMINARY DESIGN
STRAIGHT TRAPEZOIDAL STEEL GIRDER

WHIT-P212-S01

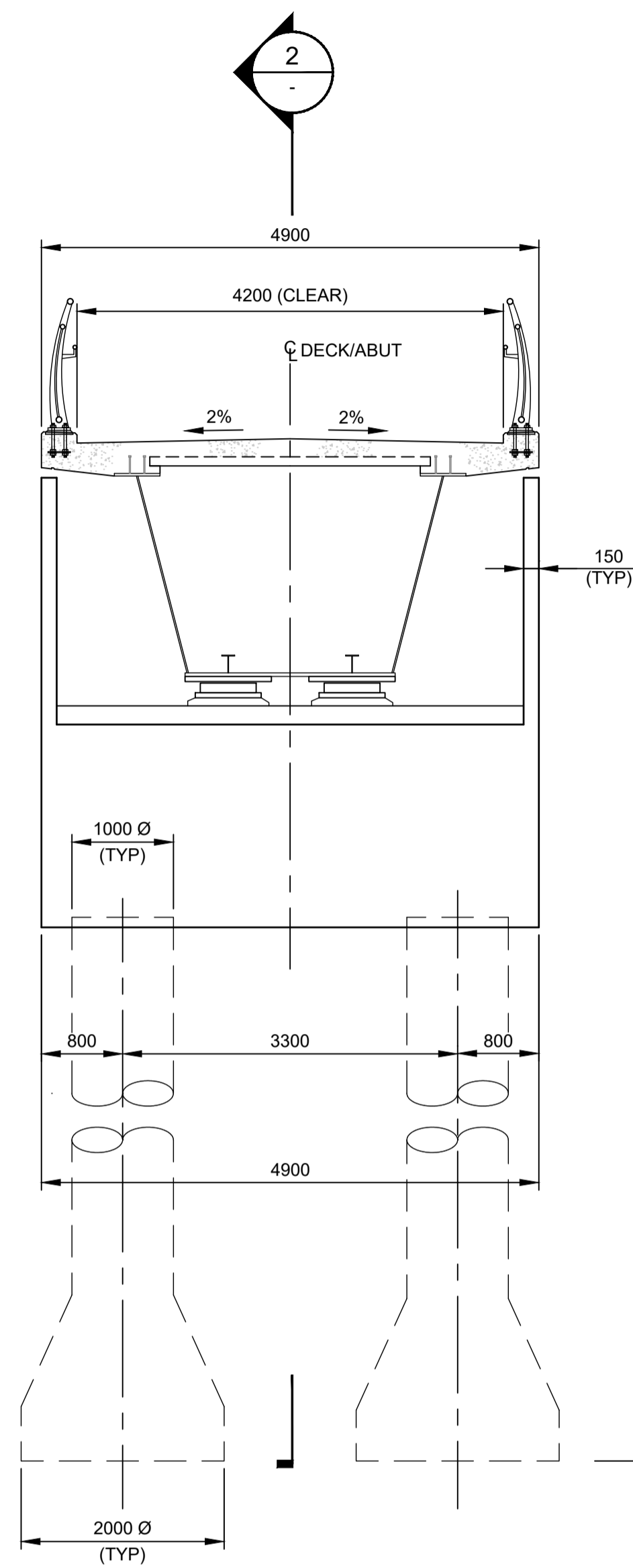

APPROX PILE TIP EL. 636.0 (ABUTMENT 1)
APPROX PILE TIP EL. 623.0 (ABUTMENT 2)

1 SECTION 1:50
ABUTMENT

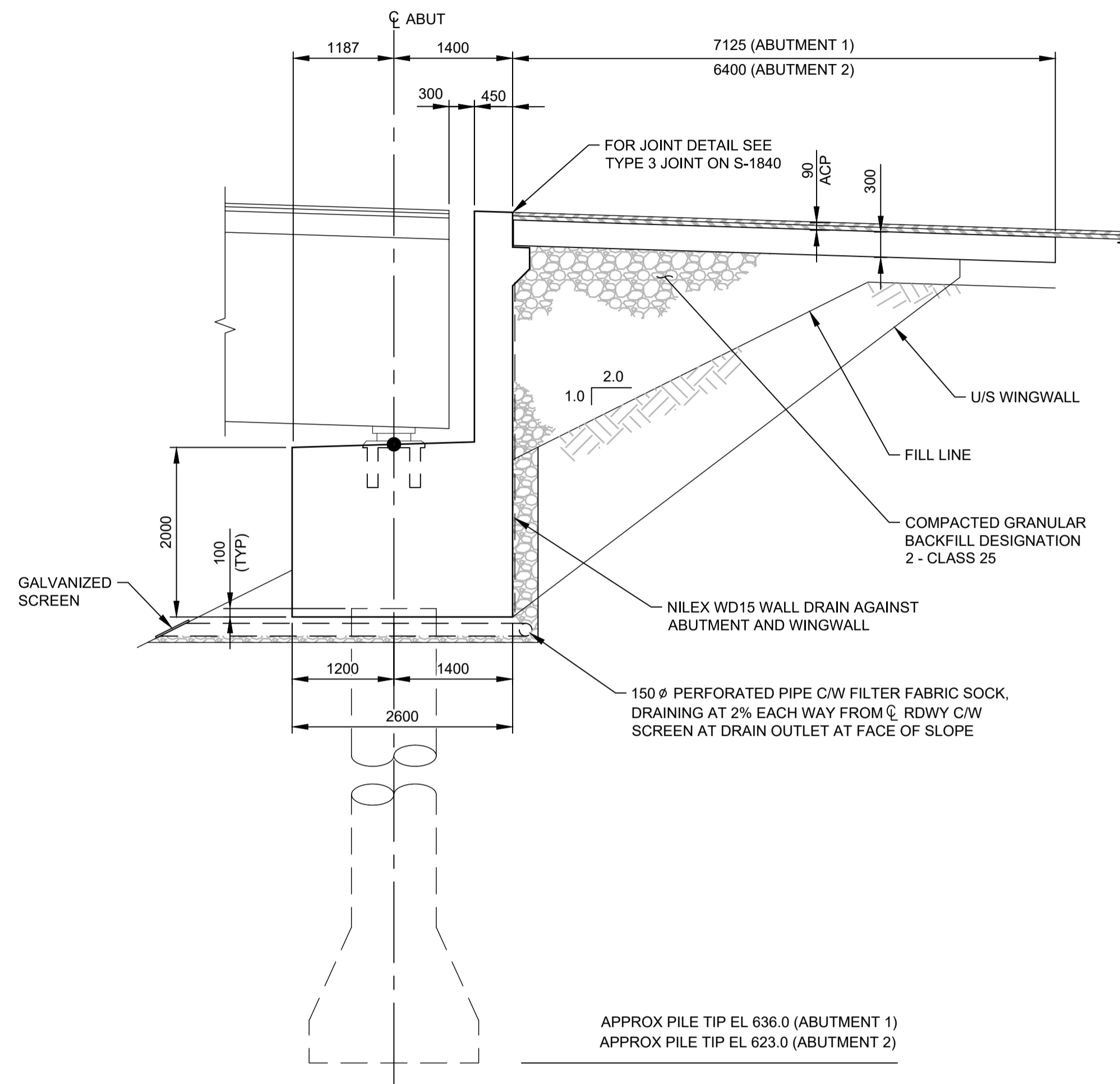

APPROX PILE TIP EL. 636.0 (ABUTMENT 1)
APPROX PILE TIP EL. 623.0 (ABUTMENT 2)

2 SECTION 1:50

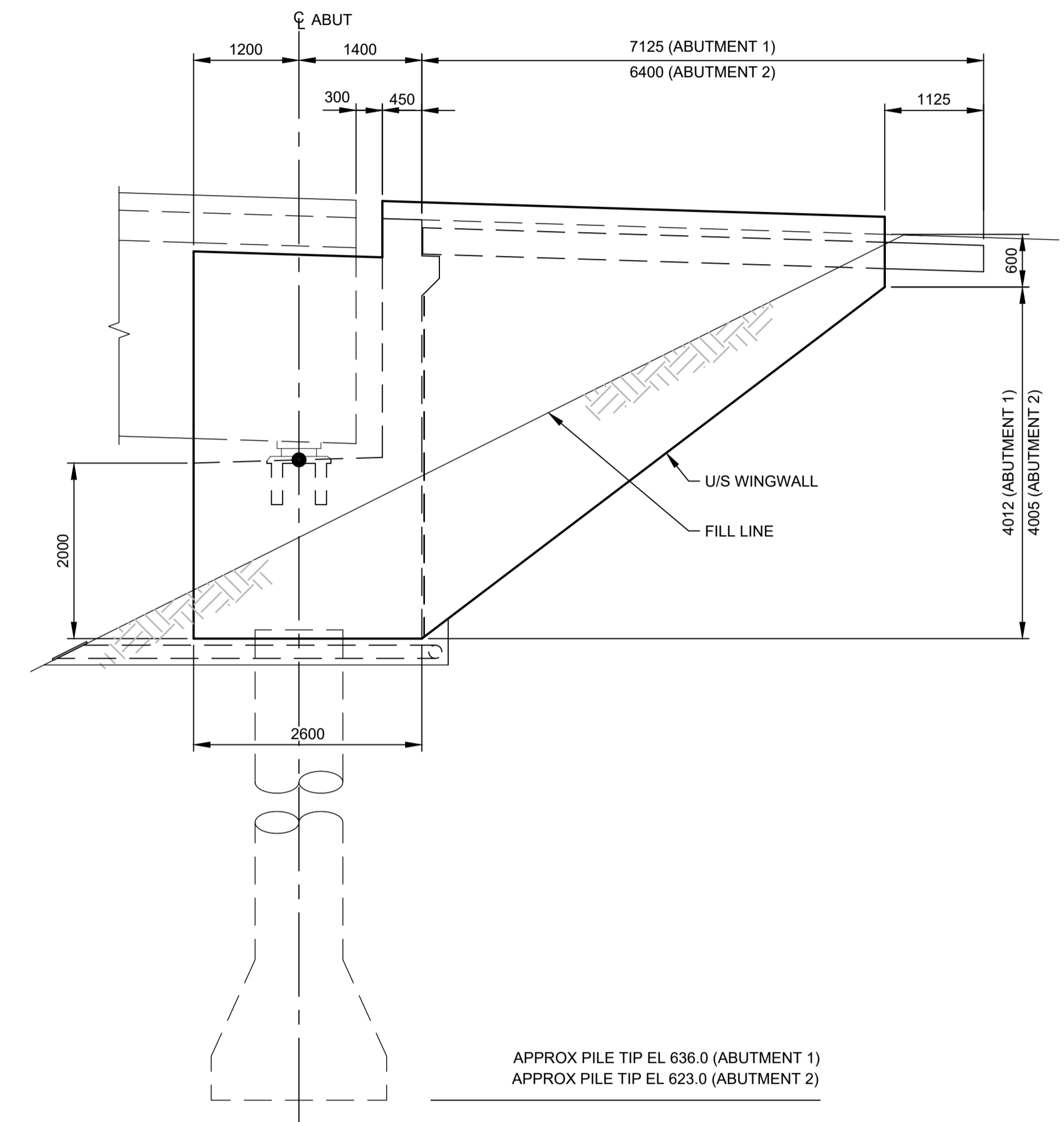

APPROX PILE TIP EL. 636.0 (ABUTMENT 1)
APPROX PILE TIP EL. 623.0 (ABUTMENT 2)

ELEVATION 1:50

NOTES

- DIMENSIONS ARE GIVEN IN MILLIMETERS UNLESS NOTED OTHERWISE
- ELEVATIONS ARE GIVEN IN METERS UNLESS NOTED OTHERWISE

**PRELIMINARY DESIGN
NOT FOR CONSTRUCTION**

7					
6					
5					
4					
3					
2					
1					
NO.	REVISIONS	BY	DATE	APPD	

PROGRAM NO.	
CONTRACT NO.	
AS BUILT / TO GBS	
TENDER AWARD DATE	
ISSUE	
BY	
DATE	

CONSTRUCTION RETURN	
CONTRACTOR	
SURVEYOR	
DATE	
FILE NUMBER	
CONSTRUCTION ENGINEER	
DATE	
GENERAL SUPERVISOR	
DATE	

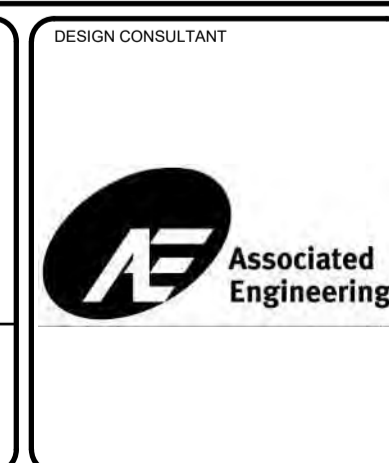

PERMIT TO PRACTICE
ASSOCIATED ENGINEERING ALBERTA LTD.

Signature: *[Signature]* 2021-09-23
Member No. P-1123
Permit Number: P 03979
The Association of Professional Engineers and Geoscientists of Alberta

APPROVED FOR CONSTRUCTION

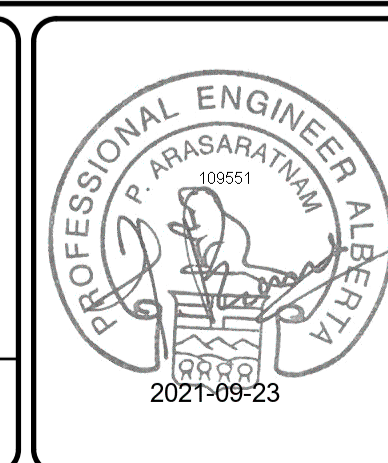

TRANSPORTATION PLANNING AND DESIGN SUPERVISOR	
TRANSPORTATION INFRASTRUCTURE DELIVERY SUPERVISOR	
DEPARTMENT / BRANCH	
APPROVAL	
DATE	

DIRECTOR OF TRANSPORTATION PLANNING AND DESIGN	DATE
	MM/DD/YY
SURVEY	
JOB NO.	
SCALE	
SCALES SHOWN ARE CORRECT FOR FULL SIZE PLOTS (A1 SHEET SIZE)	
DRAWN	DATE
R. XU	JUN 2021
DESIGNED	DATE
L. ARASARATNAM	JUN 2021
CHECKED	DATE
M. PAULSEN	JUN 2021

Edmonton INTEGRATED INFRASTRUCTURE SERVICES
INFRASTRUCTURE PLANNING AND DESIGN BRANCH

PROJECT: **TERWILLEGAR DRIVE EXPANSION - STAGE 2**
PRELIMINARY DESIGN
STRAIGHT TRAPEZOIDAL STEEL GIRDER DETAILS

DRAWING: **WHIT-P212-S02**

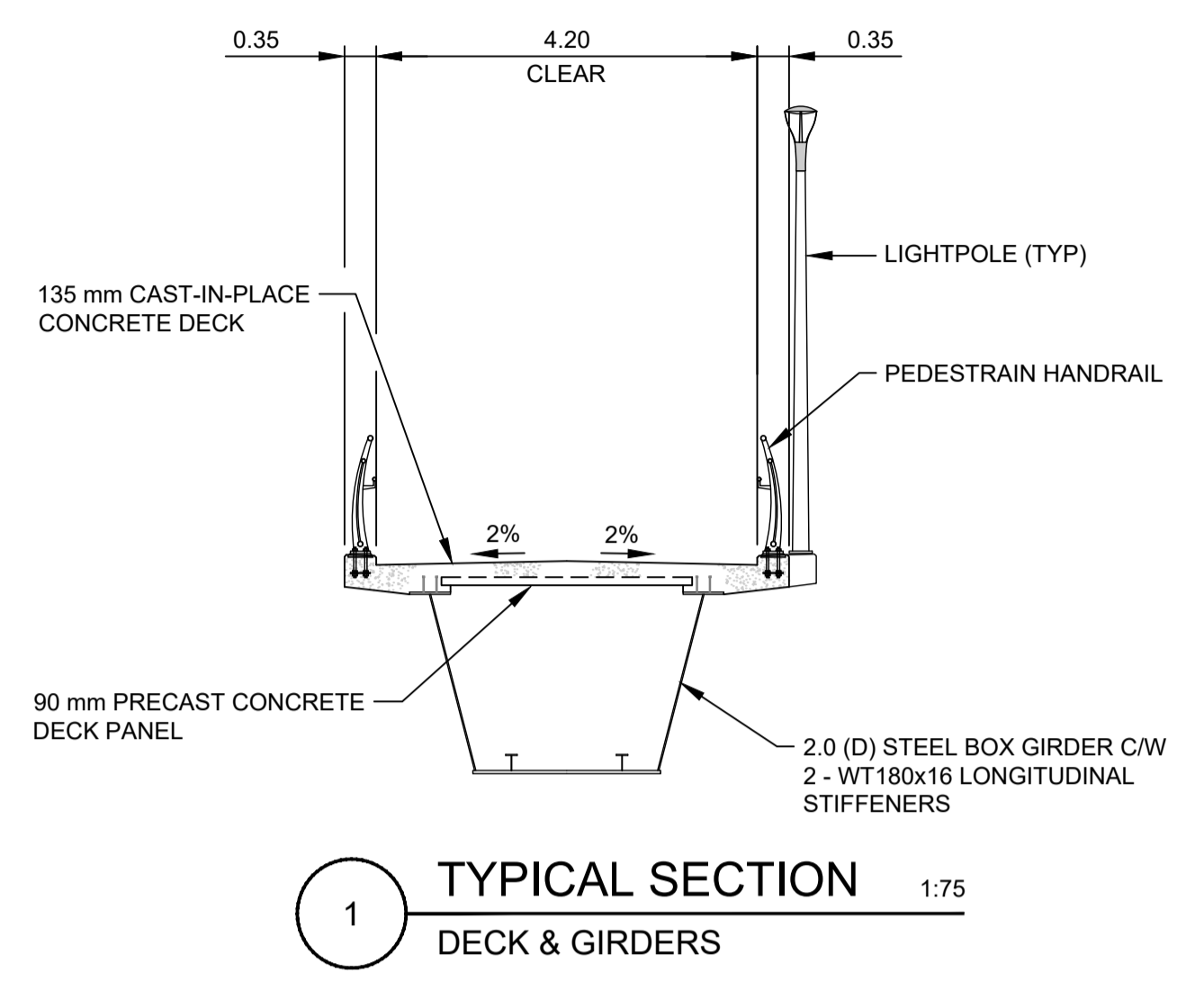
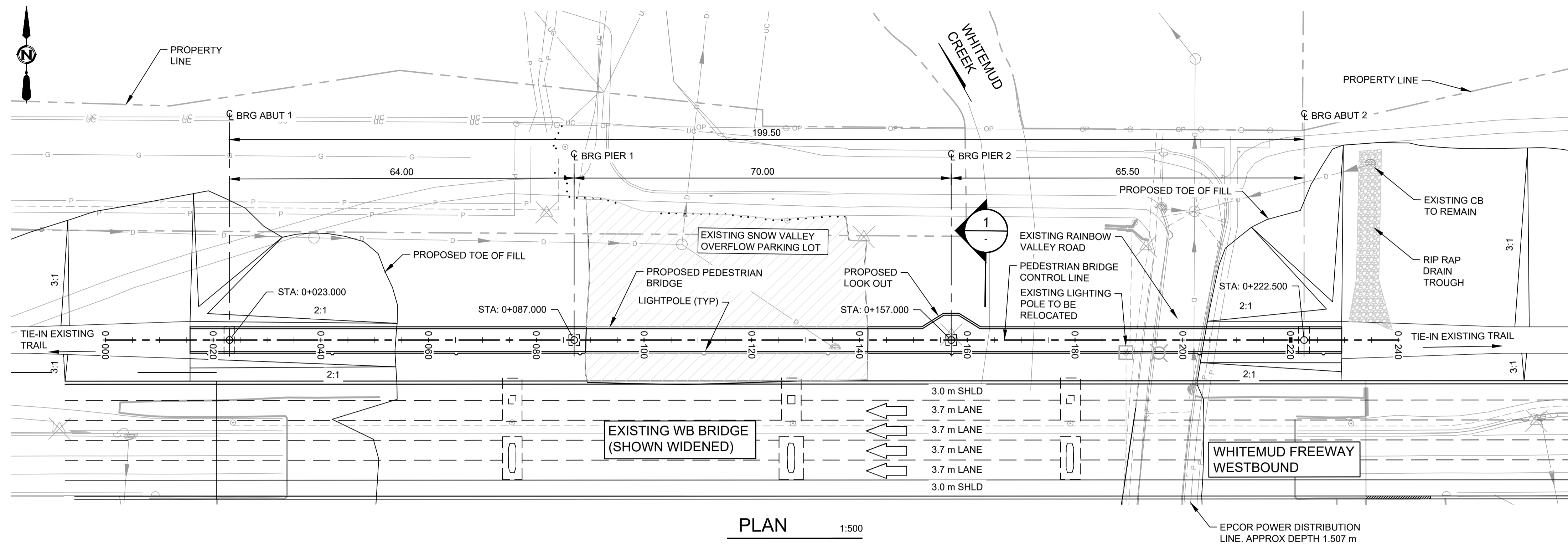

CONCEPTUAL RENDERING NTS
LOOKING FROM ABOVE



CONCEPTUAL RENDERING NTS
LOOKING FROM BELOW

**PRELIMINARY DESIGN
NOT FOR CONSTRUCTION**

7					
6					
5					
4					
3					
2					
1					
NO.	REVISIONS	BY	DATE	APPD	

PROGRAM NO.			
CONTRACT NO.			
AS BUILT / TO GBS			
TENDER AWARD DATE			
NO.	ISSUE	BY	DATE

CONSTRUCTION RETURN	
CONTRACTOR	
SURVEYOR	
DATE	
FILE NUMBER	
CONSTRUCTION ENGINEER	DATE
GENERAL SUPERVISOR	DATE

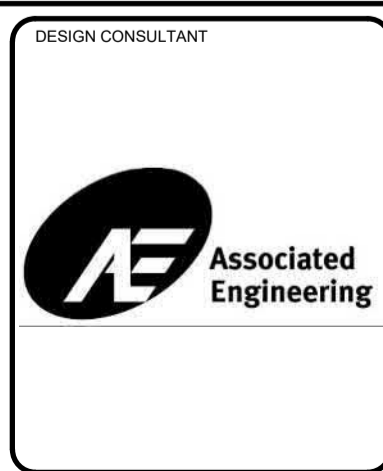

PERMIT TO PRACTICE
ASSOCIATED ENGINEERING ALBERTA LTD.
Signature: [Signature] 2021-09-23
Permit No. P 03979
The Association of Professional Engineers and Geoscientists of Alberta
APPROVED FOR CONSTRUCTION



TRANSPORTATION PLANNING AND DESIGN SUPERVISOR		
TRANSPORTATION INFRASTRUCTURE DELIVERY SUPERVISOR		
DEPARTMENT / BRANCH	APPROVAL	DATE

DIRECTOR OF TRANSPORTATION PLANNING AND DESIGN	DATE
	MM/DD/YY
SURVEY	DATE
JOB NO.	
SCALE	
SCALES SHOWN ARE CORRECT FOR FULL SIZE PLOTS (A1 SHEET SIZE)	
CHECKED	DATE
M. PAULSEN	JUN 2021

Edmonton INTEGRATED INFRASTRUCTURE SERVICES
INFRASTRUCTURE PLANNING AND DESIGN BRANCH

PROJECT: **TERWILLEGAR DRIVE EXPANSION - STAGE 2**
PRELIMINARY DESIGN
STRAIGHT TRAPEZOIDAL STEEL GIRDER RENDERING

DRAWING: **WHIT-P212-S03**

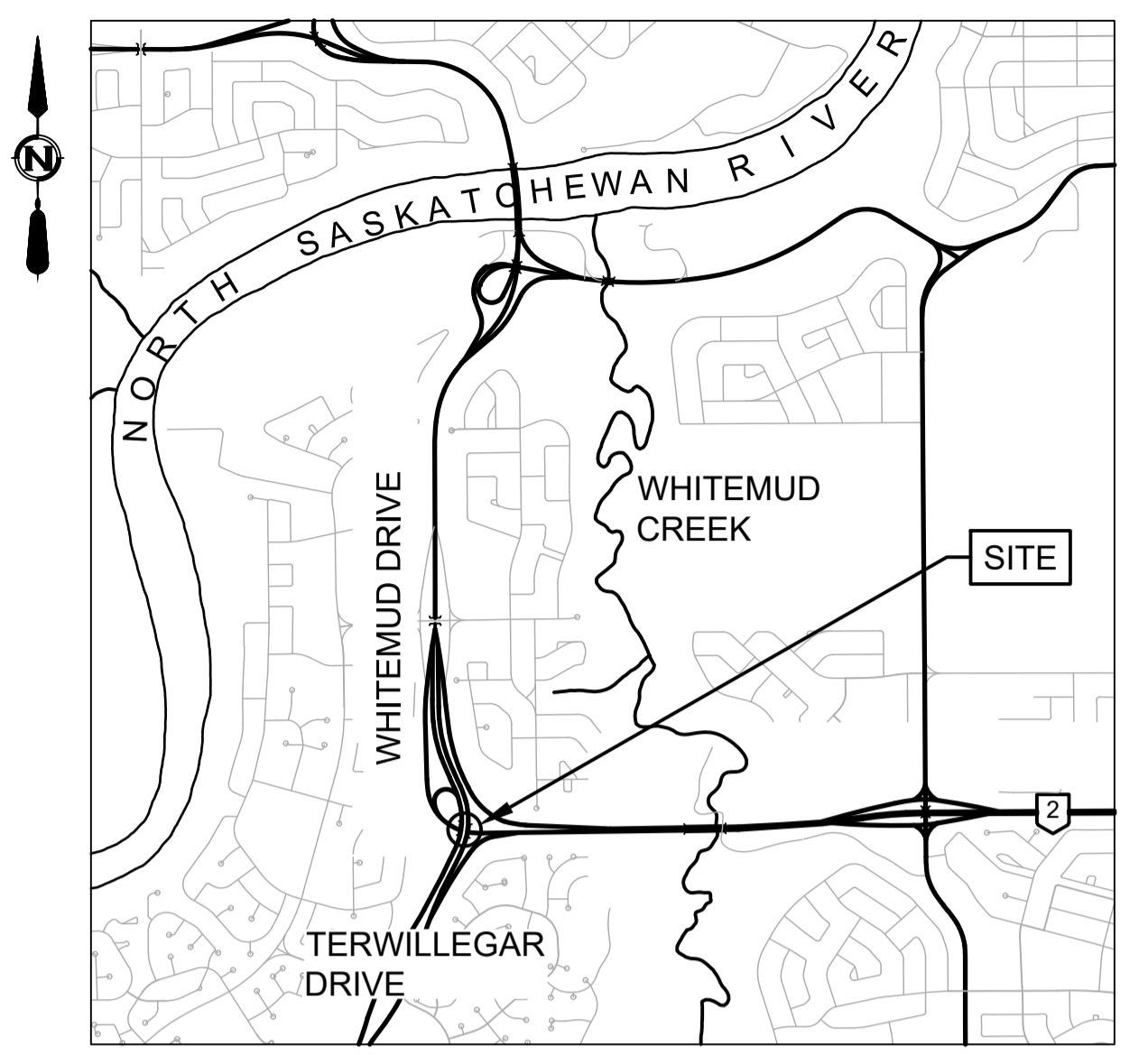
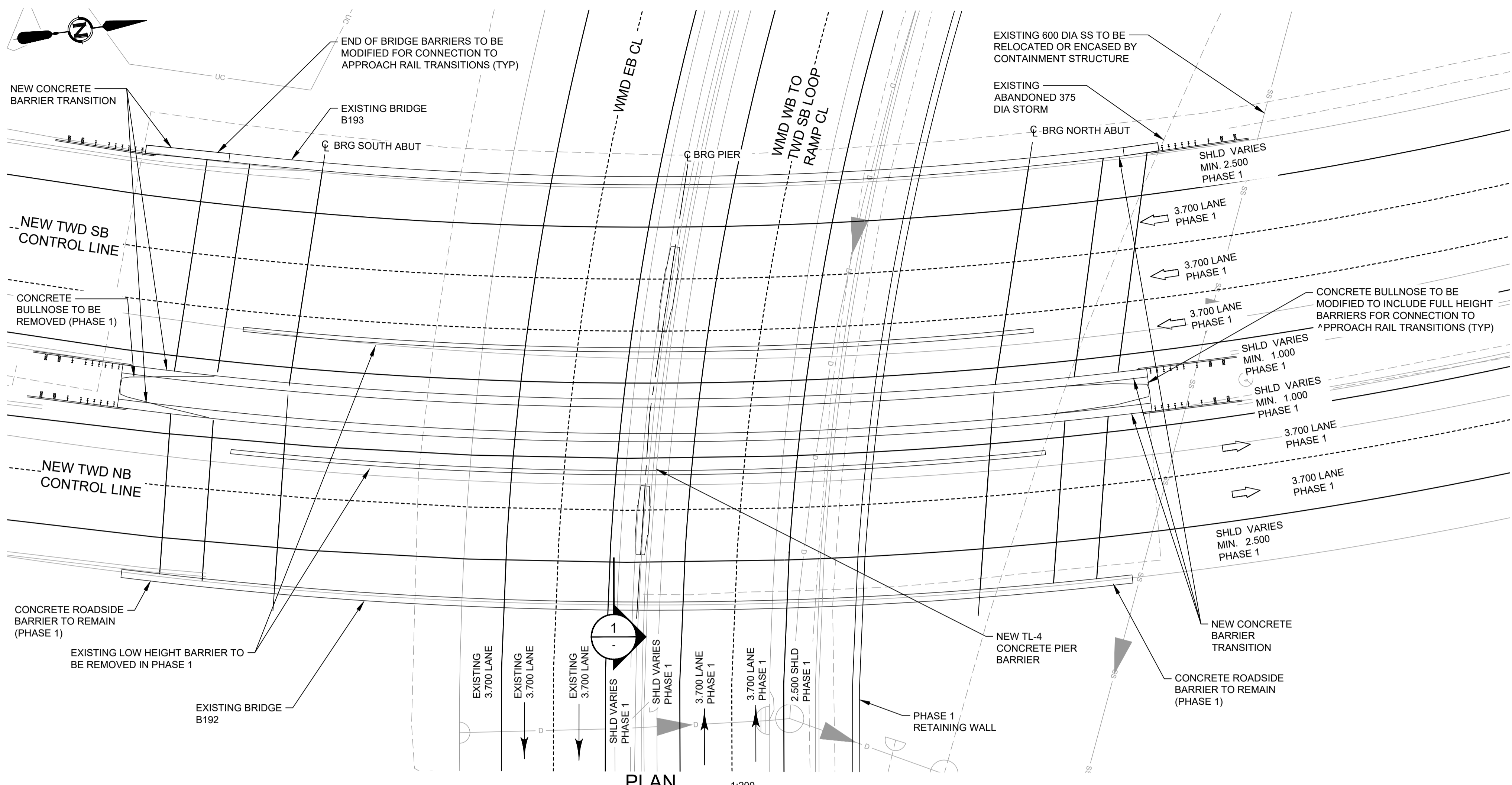

SITE PLAN

NOTES

- ALL DIMENSIONS ARE IN METERS UNLESS NOTED OTHERWISE
- UTILITY LEGEND
- CATCH BASIN MANHOLE
 - CATCH BASIN
 - DRAINAGE MANHOLE (SANITARY)
 - DRAINAGE MANHOLE (STORM)
 - STREET LIGHT
 - STREET LIGHT
 - EXISTING STORM DRAINAGE
 - EXISTING ABANDONED STORM
 - EXISTING SANITARY DRAINAGE
 - EXISTING OVERHEAD POWER
 - EXISTING UNDERGROUND POWER
 - EXISTING STREETLIGHT POWER
 - EXISTING ATCO GAS LINE
 - EXISTING TELUS UNDERGROUND
 - EXISTING EPCOR WATER

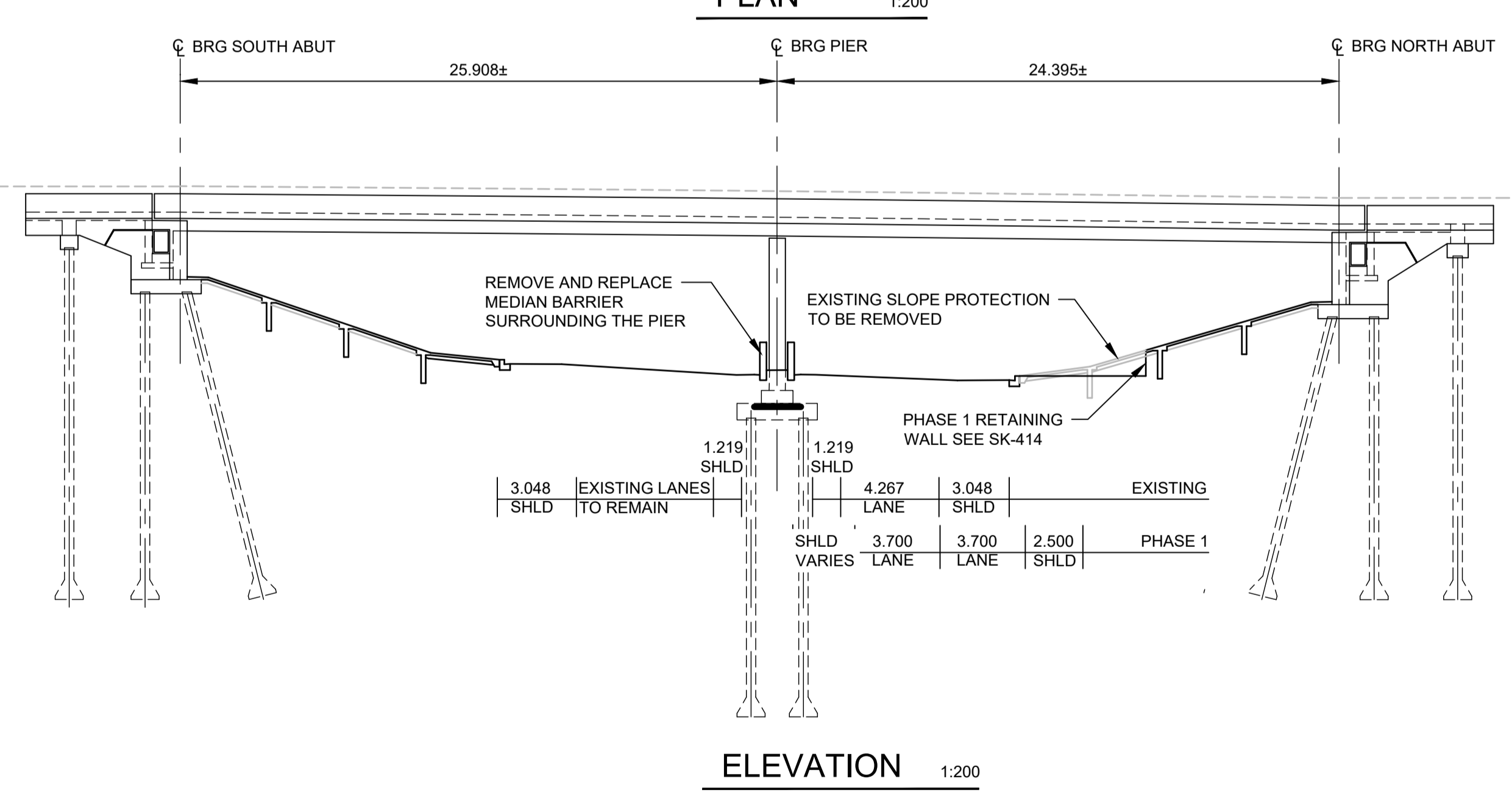

ELEVATION 1:200

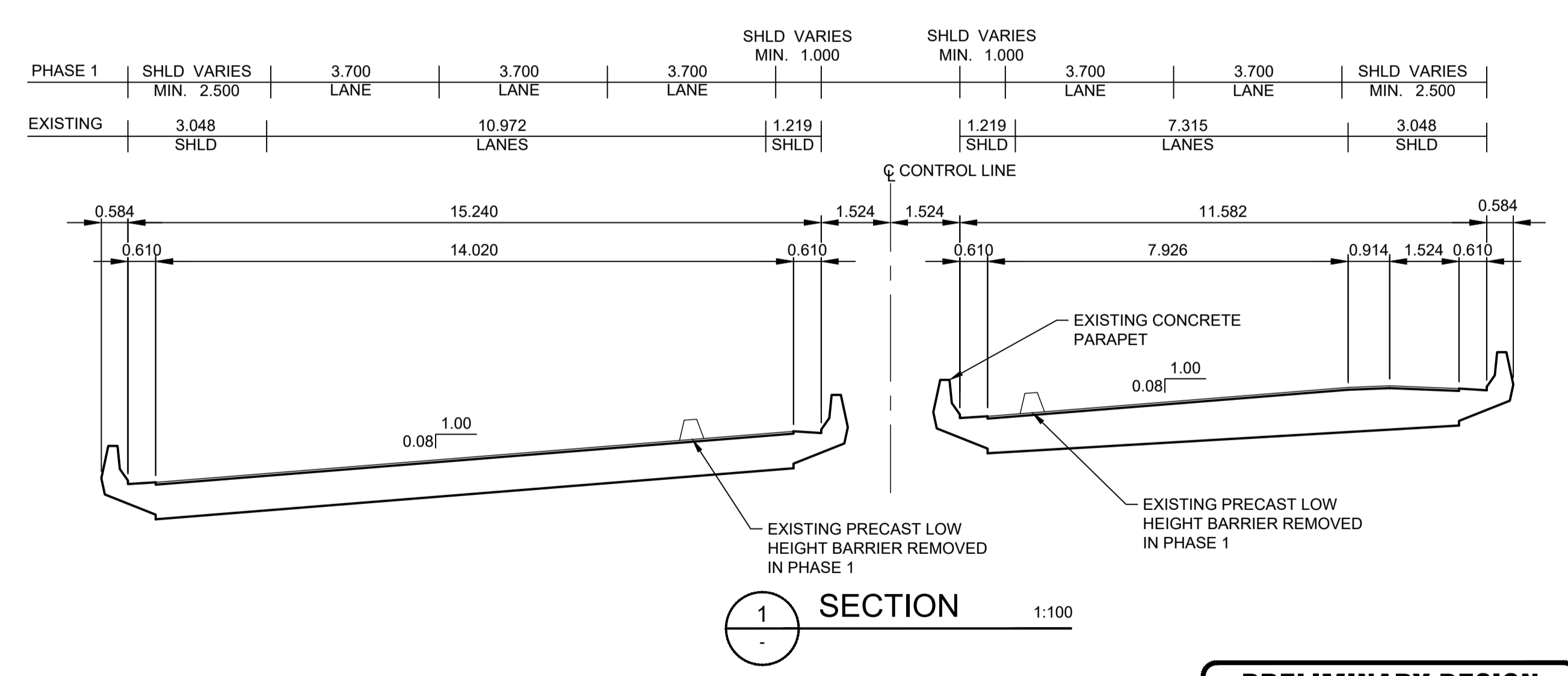

SECTION 1:100

**PRELIMINARY DESIGN
NOT FOR CONSTRUCTION**

NO.	REVISIONS	BY	DATE	APPD
7				
6				
5				
4				
3				
2				
1				

PROGRAM NO.			
CONTRACT NO.			
AS BUILT / TO GBS			
TENDER AWARD DATE			
NO.	ISSUE	BY	DATE

CONSTRUCTION RETURN	
CONTRACTOR	
SURVEYOR	
DATE	
FILE NUMBER	
CONSTRUCTION ENGINEER	DATE
GENERAL SUPERVISOR	DATE

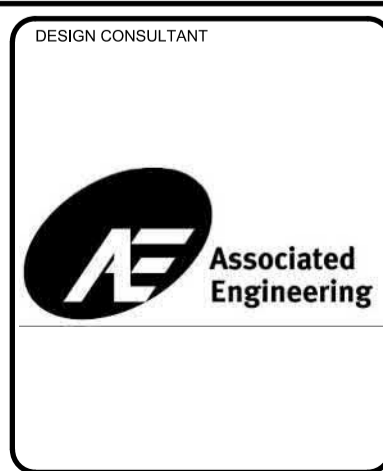

PERMIT TO PRACTICE
ASSOCIATED ENGINEERING ALBERTA LTD.
Signature: [Signature]
2021-09-23
PERMIT NUMBER: P 03979
The Association of Professional Engineers and Geoscientists of Alberta
APPROVED FOR CONSTRUCTION

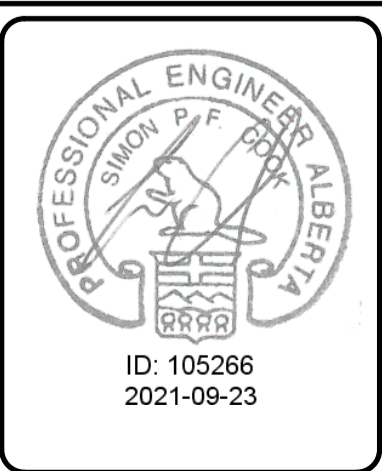

TRANSPORTATION PLANNING AND DESIGN SUPERVISOR	
TRANSPORTATION INFRASTRUCTURE DELIVERY SUPERVISOR	
DEPARTMENT / BRANCH	APPROVAL
	DATE

DIRECTOR OF TRANSPORTATION PLANNING AND DESIGN	DATE
	MM/DD/YY
SURVEY	DATE
JOB NO.	
SCALE	
SCALES SHOWN ARE CORRECT FOR FULL SIZE PLOTS (A1 SHEET SIZE)	
DRAWN	DATE
R. XU	JUN 2021
DESIGNED	DATE
S. COOK	JUN 2021
CHECKED	DATE
T. ALEXANDER	JUN 2021

Edmonton INTEGRATED INFRASTRUCTURE SERVICES
INFRASTRUCTURE PLANNING AND DESIGN BRANCH

PROJECT: **TERWILLEGAR DRIVE EXPANSION - STAGE 2**
PRELIMINARY DESIGN
GENERAL LAYOUT - PHASE 1

DRAWING: **TERW-P211-S01**

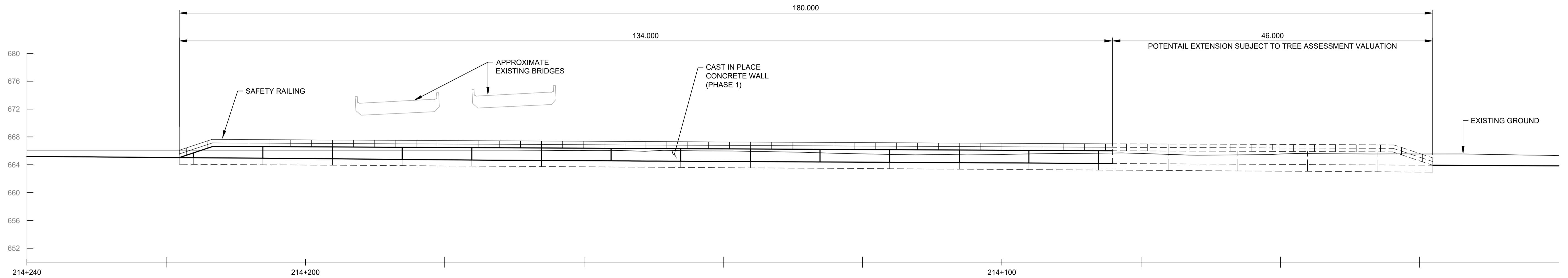

ELEVATION 1:300
 WHITEMUD DRIVE WB TO TERWILLIGER DRIVE SB LOOP RAMP
 LOOKING NORTH

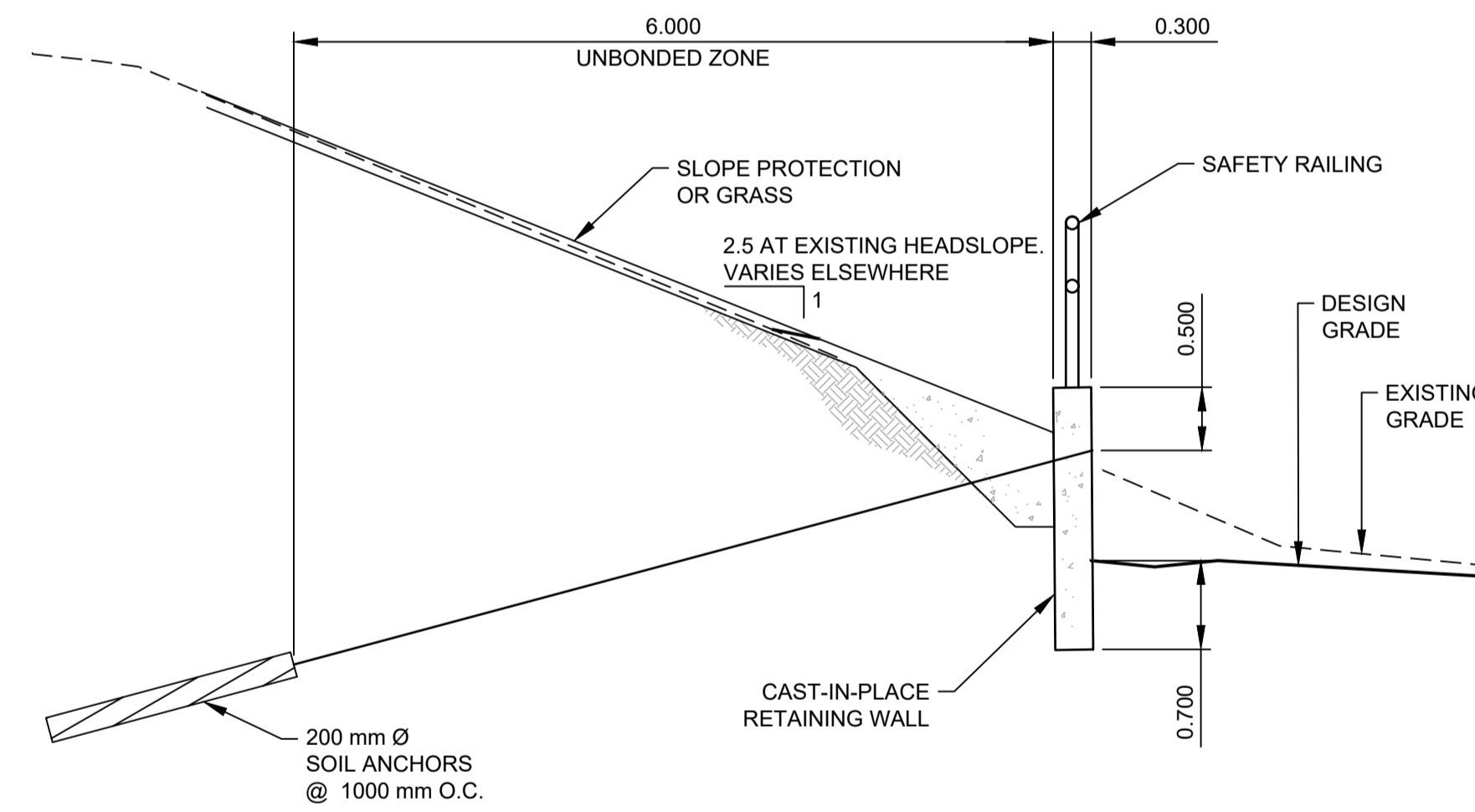

TYPICAL SECTION 1:50
 CAST IN PLACE WALL

**PRELIMINARY DESIGN
 NOT FOR CONSTRUCTION**

7					
6					
5					
4					
3					
2					
1					
NO.	REVISIONS	BY	DATE	APPD	

PROGRAM NO. _____					
CONTRACT NO. _____					
4					
3					
2					
1					
NO.	ISSUE	BY	DATE		

CONSTRUCTION RETURN	
CONTRACTOR	_____
SURVEYOR	_____
DATE	_____
FILE NUMBER	_____
CONSTRUCTION ENGINEER	DATE
GENERAL SUPERVISOR	DATE

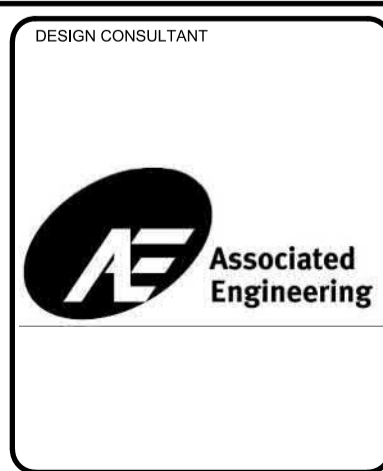

PERMIT TO PRACTICE
 ASSOCIATED ENGINEERING ALBERTA LTD.
 Signature: _____
 Michael W. Fraser
 Permit No. P 03979
 2021-09-23
 The Association of Professional Engineers
 and Geoscientists of Alberta

APPROVED FOR CONSTRUCTION

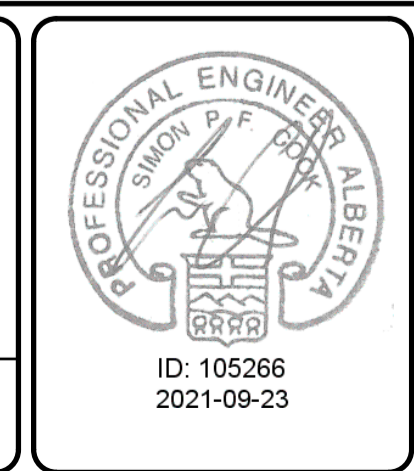

TRANSPORTATION PLANNING AND DESIGN SUPERVISOR		
TRANSPORTATION INFRASTRUCTURE DELIVERY SUPERVISOR		
DEPARTMENT / BRANCH	APPROVAL	DATE

DIRECTOR OF TRANSPORTATION PLANNING AND DESIGN		DATE
_____		MM/DD/YY
SURVEY	_____	DATE
JOB NO.	_____	DATE
SCALE	SCALES SHOWN ARE CORRECT FOR FULL SIZE PLOTS (A1 SHEET SIZE)	
DRAWN	S. MURRAY	AUG 2021
DESIGNED	S. COOK	AUG 2021
CHECKED	T. ALEXANDER	AUG 2021

Edmonton INTEGRATED INFRASTRUCTURE SERVICES
 INFRASTRUCTURE PLANNING AND DESIGN BRANCH

PROJECT: **TERWILLEGAR DRIVE EXPANSION - STAGE 2
 PRELIMINARY DESIGN
 PHASE 1 RETAINING WALL**

DRAWING: **TERW-P212-S01**

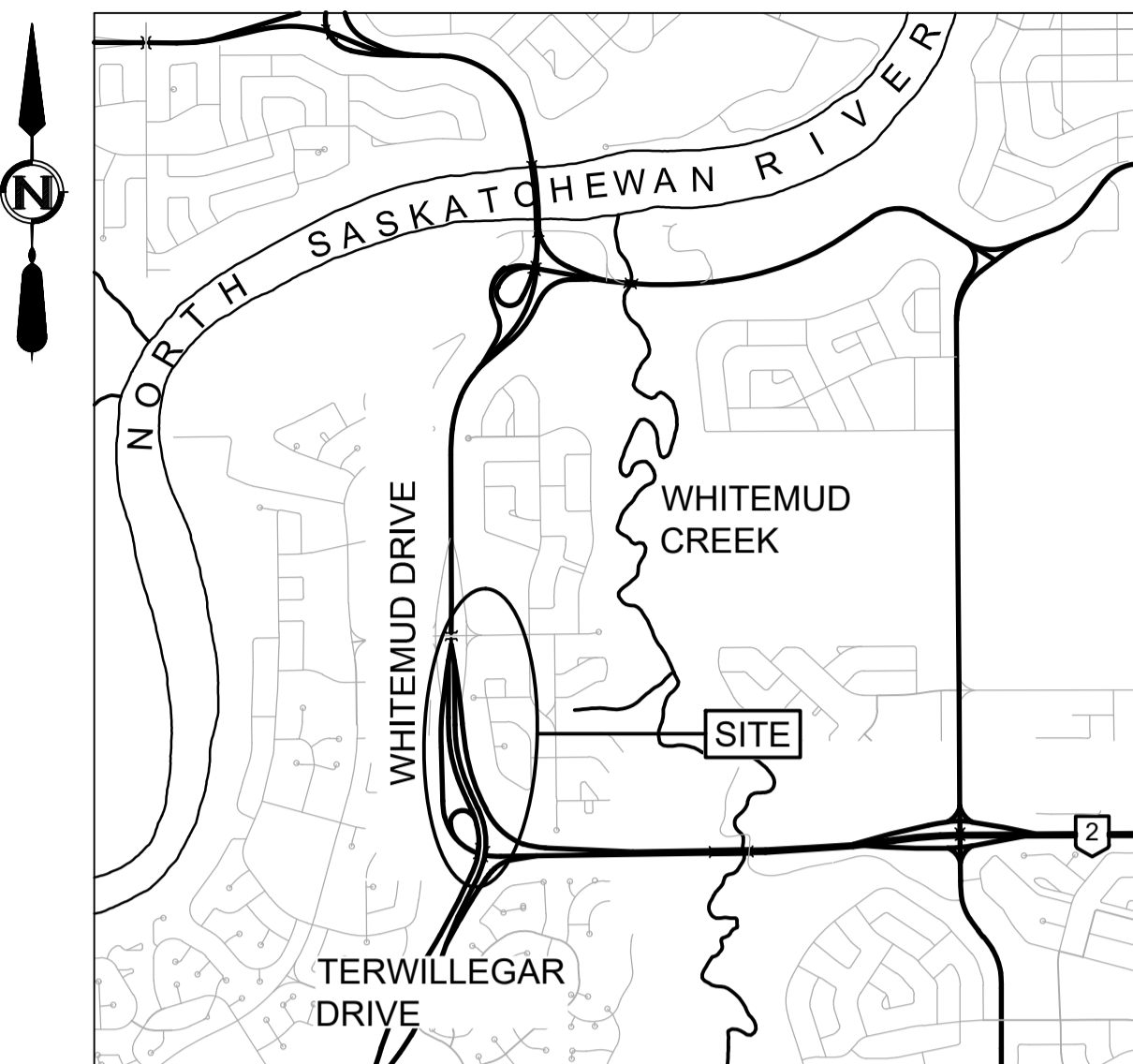
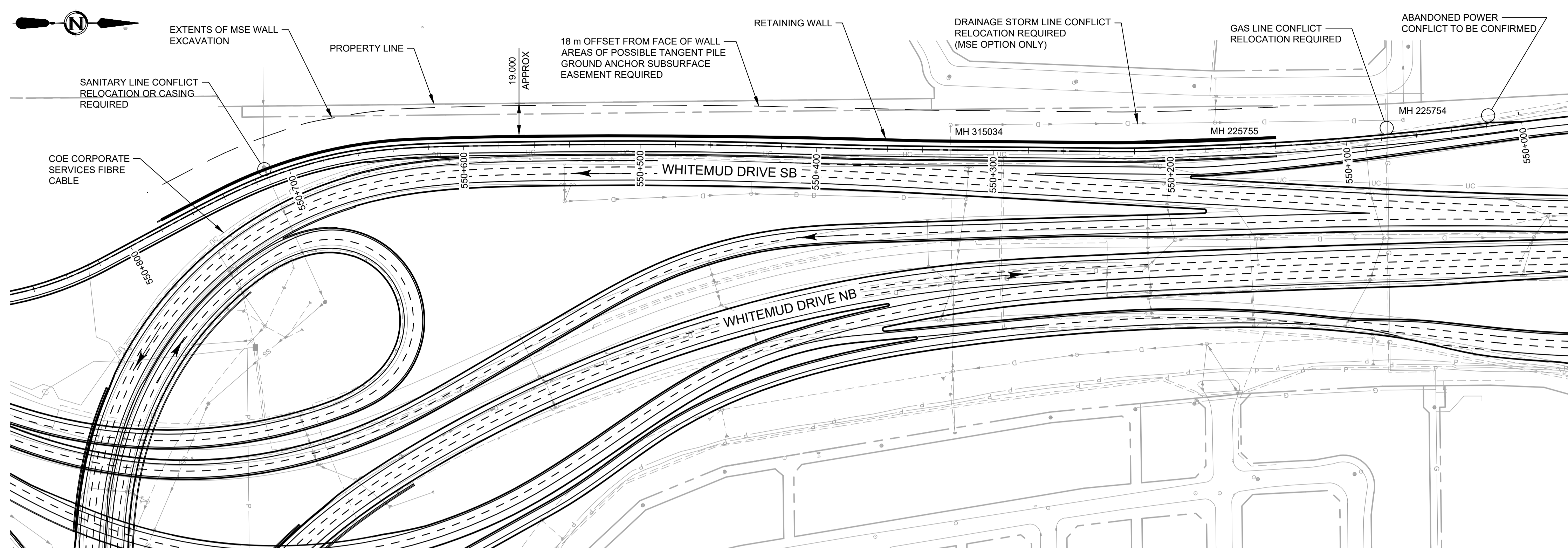

SITE PLAN

NOTES

- ALL DIMENSIONS ARE IN METERS UNLESS NOTED OTHERWISE

PLAN 1:1500

UTILITY LEGEND

- CATCH BASIN MANHOLE
- CATCH BASIN
- DRAINAGE MANHOLE (SANITARY)
- DRAINAGE MANHOLE (STORM)
- STREET LIGHT
- STREET LIGHT
- EXISTING STORM DRAINAGE
- EXISTING SANITARY DRAINAGE
- EXISTING OVERHEAD POWER
- EXISTING UNDERGROUND POWER
- EXISTING STREETLIGHT POWER
- EXISTING ATCO GAS LINE
- EXISTING UNDERGROUND FIBRE DATA LINE
- EXISTING EPCOR WATER

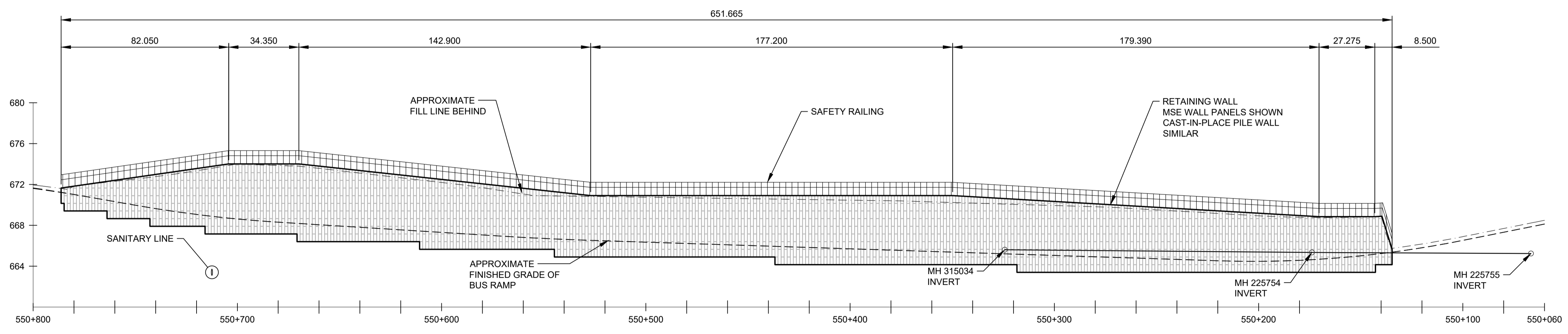

ELEVATION H 1:1250 V 1:250
LOOKING WEST

**PRELIMINARY DESIGN
NOT FOR CONSTRUCTION**

7					
6					
5					
4					
3					
2					
1					
NO.	REVISIONS	BY	DATE	APPD	

PROGRAM NO.			
CONTRACT NO.			
AS BUILT / TO GIS			
TENDER AWARD DATE			
NO.	ISSUE	BY	DATE

CONSTRUCTION RETURN	
CONTRACTOR	
SURVEYOR	
DATE	
FILE NUMBER	
CONSTRUCTION ENGINEER	DATE
GENERAL SUPERVISOR	DATE

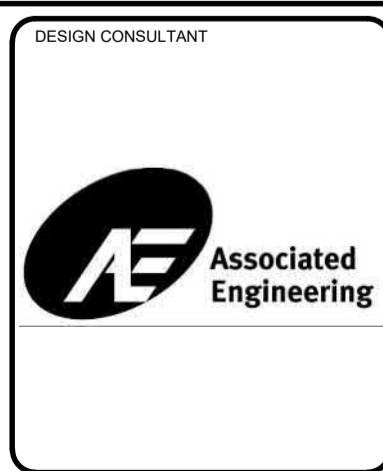

PERMIT TO PRACTICE
ASSOCIATED ENGINEERING ALBERTA LTD.
Signature: *[Signature]* 2021-09-24
Permit Number: P 03979
The Association of Professional Engineers and Geoscientists of Alberta
APPROVED FOR CONSTRUCTION



TRANSPORTATION PLANNING AND DESIGN SUPERVISOR	
TRANSPORTATION INFRASTRUCTURE DELIVERY SUPERVISOR	
DEPARTMENT / BRANCH	
APPROVAL	DATE

DIRECTOR OF TRANSPORTATION PLANNING AND DESIGN	DATE
	MM/DD/YY
SURVEY	
JOB NO.	
SCALE	
SCALES SHOWN ARE CORRECT FOR FULL SIZE PLOTS (A1 SHEET SIZE)	
DRAWN	DATE
S. MURRAY	JUN 2021
DESIGNED	DATE
M. TOKAR	JUN 2021
CHECKED	DATE
T. ALEXANDER	JUN 2021

Edmonton INTEGRATED INFRASTRUCTURE SERVICES
INFRASTRUCTURE PLANNING AND DESIGN BRANCH

PROJECT: **TERWILLEGAR DRIVE EXPANSION - STAGE 2**
PRELIMINARY DESIGN
GENERAL LAYOUT - BUS RAMP RETAINING WALL

DRAWING: **WHIT-P213-S01**

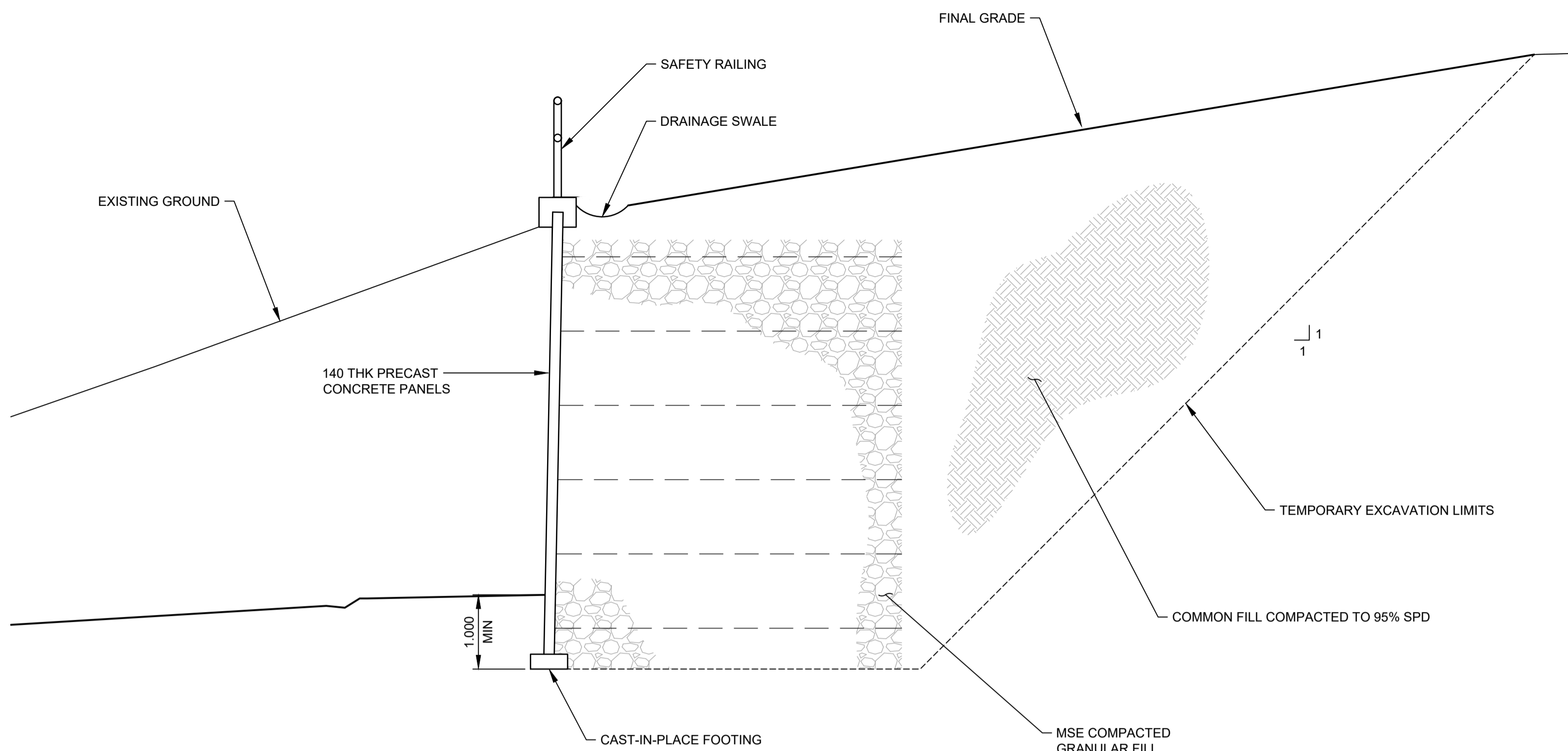

TYPICAL SECTION 1:50
 MSE WALL
 LOOKING SOUTH

**PRELIMINARY DESIGN
 NOT FOR CONSTRUCTION**

7					
6					
5					
4					
3					
2					
1					
NO.	REVISIONS	BY	DATE	APPD	

PROGRAM NO.	
CONTRACT NO.	
NO.	
ISSUE	
BY	
DATE	

CONSTRUCTION RETURN	
CONTRACTOR	
SURVEYOR	
DATE	
FILE NUMBER	
CONSTRUCTION ENGINEER	DATE
GENERAL SUPERVISOR	DATE

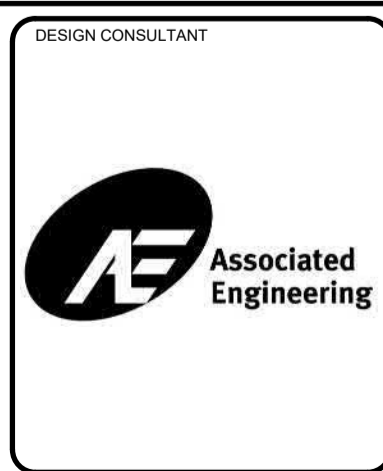

PERMIT TO PRACTICE
 ASSOCIATED ENGINEERING ALBERTA LTD.
 Signature: *[Signature]*
 Michael M. Peterson
 Permit Number: P 03979
 2021-09-24
 The Association of Professional Engineers and Geoscientists of Alberta
 APPROVED FOR CONSTRUCTION
 DATE



TRANSPORTATION PLANNING AND DESIGN SUPERVISOR		
TRANSPORTATION INFRASTRUCTURE DELIVERY SUPERVISOR		
DEPARTMENT / BRANCH	APPROVAL	DATE

DIRECTOR OF TRANSPORTATION PLANNING AND DESIGN	DATE
	MM/DD/YY
SURVEY	
JOB NO.	
SCALE	
SCALES SHOWN ARE CORRECT FOR FULL SIZE PLOTS (A1 SHEET SIZE)	
DRAWN	DATE
S. MURRAY	JUN 2021
DESIGNED	DATE
M. TOKAR	JUN 2021
CHECKED	DATE
T. ALEXANDER	JUN 2021

Edmonton INTEGRATED INFRASTRUCTURE SERVICES
 INFRASTRUCTURE PLANNING AND DESIGN BRANCH

PROJECT: **TERWILLEGAR DRIVE EXPANSION - STAGE 2**
PRELIMINARY DESIGN
 BUS RAMP RETAINING WALL

DRAWING: **WHIT-P213-S02**

APPENDIX H - DRAFT NOISE IMPACT ASSESSMENT

Environmental Noise Impact Assessment
For

**Terwillegar Drive Stage 2
Preliminary Design**

Prepared for:
CIMA +

Prepared by:
P. Froment, B.Sc., B.Ed., P.L.(Eng.)
aci Acoustical Consultants Inc.
Edmonton, Alberta
APEGA Permit to Practice #P7735

08/27/2021

**aci Project #: 21-015
August 27, 2021**

Disclaimer

This report has been prepared by **aci** Acoustical Consultants Inc. (**aci**) in response to a specific request for service from, and for the exclusive use of, the Client to whom the report is addressed. The report has been prepared in a manner consistent with a level of care and skill ordinarily exercised by members of the engineering and science professions currently practising under similar conditions in the jurisdiction in which the services are provided, subject to the time limits and physical constraints applicable to this report. The findings contained in this report are based, in part, upon information provided by others. **aci** does not vouch for the accuracy of information provided by others or how that may impact the accuracy of the results presented in the report. The information contained in this report is not intended for use of, nor is it intended to be relied upon, by any person, firm, or corporation other than the Client to whom it is addressed, with the exception of the applicable regulatory authority to whom this document may be submitted. Any, calculation methods and noise models prepared by **aci** are considered proprietary professional work product and shall remain the copyright property of **aci** who authorizes only the Client to use and make copies of the report.

The report is of a summary nature and is not intended to stand alone without reference to the instructions given to **aci** by the Client, communications between **aci** and the Client, and to any other reports prepared by **aci** for the Client relative to the specific project described in the report. In order to properly understand the suggestions, recommendations, and opinions expressed in this report, reference must be made to the whole of the report. **aci** cannot be responsible for use of portions of the report without reference to the entire report. **aci** accepts no liability or responsibility for any damages that may be suffered or incurred by any third party as a result of the use of, reliance on, or any decision made based on this report.

Unless otherwise stated, the suggestions, recommendations, and opinions given in this report are intended only for guidance of the Client in the design of the specific project. The extent and detail of investigations, necessary to determine all of the relevant conditions which may affect potential project construction costs would normally be greater than has been carried out for design purposes. Any Contractors bidding on, or undertaking work discussed in this report, should rely on their own investigations, as well as their own interpretations of the factual data presented in the report, including but not limited to proposed construction techniques, materials selected, schedule, safety and equipment capabilities.

Executive Summary

aci Acoustical Consultants Inc., of Edmonton AB, was retained by CIMA + to conduct an environmental noise impact assessment for the Terwillegar Drive Stage 2 Preliminary Design and Delivery Project (the Project) in Edmonton, Alberta. The purpose of the work was to conduct 24-hour environmental noise monitoring at various locations adjacent to the roadways which were then used to enhance a computer noise model of the study area under current and future traffic conditions. This was then used to determine the noise attenuation measures required to meet the criteria of the City of Edmonton Urban Traffic Noise Policy (UTNP), C506A. Site work was conducted for aci in April 2021 by P. Froment, B.Sc., B.Ed., P.L.(Eng.).

The results of the Current Conditions noise monitoring indicated noise levels ranging from 52.8 dBA to 68.9 dBA L_{eq24} . All locations showed the typical trend of noise associated with traffic. These results confirmed that the noise levels being measured by the noise monitors were largely attributed to Whitemud Drive, Terwillegar Drive, and/or other major roadways within proximity to the noise monitors.

The noise modeling results for Current Conditions matched well with the noise measurement results for all locations. The Current Conditions modeled noise levels at the existing residential receptor locations ranged from 51.6 – 66.1 dBA. This indicated that certain receptor locations would require noise mitigation as per the requirements of the City of Edmonton UTNP C506A, particularly under future case conditions.

The noise modeling results of all residential receptor locations for the Future Conditions (with projected traffic volumes representative of 2050) indicated noise levels ranging from 53.7 – 67.3 dBA with a relative increase ranging from 0.1 dBA to 5.1 dBA. Since there were residential locations with projected noise levels above 65 dBA, as per the requirements of the City of Edmonton UTNP C506A, these locations were investigated to determine the minimum amount of noise mitigation required to reduce their projected noise levels to below 65 dBA L_{eq24} .

Noise mitigation was investigated for residents within the Ramsey Heights, Brander Gardens and Brookside communities. For residents within Ramsey Heights (between 47a Avenue and 45 Avenue) it was determined that a 1.83 m tall barrier would be required along their back property line. This resulted in projected L_{eq24} noise levels ranging from 58.1 – 60.1 dBA. Two noise wall options were provided for residents within Brander Gardens and Brookside, respectively. The resulting projected L_{eq24} noise levels for Brander Gardens ranged from 60.0 – 61.7 dBA (Wall Option #1) and 58.1 – 61.0 dBA (Wall Option #2), respectively. The resulting projected L_{eq24} noise levels for Brookside ranged from 56.8 – 63.1 dBA (Wall Option #1) and 59.0 – 63.5 dBA (Wall Options #2), respectively.

Since all residential receptor L_{eq24} noise levels are below 65 dBA throughout the entire backyard spaces, no further noise mitigation (apart from options provided within this report) will be required to meet the requirements of the City of Edmonton UTNP C506A.

Table of Contents

1.0	Introduction	1
2.0	Location Description	1
2.1.	Study Area Description	1
2.2.	Adjacent Development	1
2.3.	Topography & Vegetation.....	2
2.4.	Existing Noise Mitigation	2
2.4.1.	Northwest Barrier	2
2.4.2.	Southeast Barriers.....	3
2.5.	Future Changes within Study Area	3
3.0	Measurement & Modeling Methods.....	4
3.1.	Environmental Noise Monitoring.....	4
3.1.1.	Noise Monitoring Location Description.....	5
4.0	Computer Noise Modeling	6
4.1.1.	Noise Modeling Scenarios.....	7
4.1.2.	Noise Modeling Parameters	7
4.2.	Modeling Confidence	8
5.0	Permissible Sound Levels	9
6.0	Noise Monitoring Results.....	10
6.1.	Noise Monitoring	10
6.2.	Weather Conditions.....	11
7.0	Noise Modelling Results	12
7.1.	Current Conditions	12
7.1.1.	Monitoring Locations	12
7.1.2.	Residential Receptor Locations.....	12
7.2.	Future Conditions	15
7.3.	Future Case Conditions with Noise Mitigation.....	20
7.4.	Residents in Ramsay Heights.....	20
7.5.	Residents in Brander Gardens	21
7.5.1.	Noise Wall Option #1	21
7.5.2.	Noise Wall Option #2.....	22
7.6.	Residents in Brookside.....	23
7.6.1.	Noise Wall Option #1	23
7.6.2.	Noise Wall Option #2.....	24
8.0	Conclusion.....	25
9.0	References	26
Appendix I	MEASUREMENT EQUIPMENT USED.....	48
Appendix II	THE ASSESSMENT OF ENVIRONMENTAL NOISE (GENERAL)	58
Appendix III	SOUND LEVELS OF FAMILIAR NOISE SOURCES	70
Appendix IV	NOISE MODELLING PARAMETERS	72
Appendix V	DATA REMOVAL	74
Appendix VI	WEATHER DATA	76

List of Tables

Table 1. 2021 Noise Monitoring Results.....	10
Table 2. Noise Modeling Results Under Current Conditions at Monitor Locations.....	12
Table 3a. Current Conditions Results for Receptors North of 53 Avenue.....	13
Table 3b. Current Conditions Results for Receptors West of WMD and South of 53 Avenue.....	13
Table 3c. Current Conditions Results for Residents East of WMD and South of 53 Avenue.....	14
Table 3d. Current Conditions Results for Residents South of WMD and East of Terwillegar Drive.....	14
Table 3e. Current Conditions Results for Residents North of WMD and West of 122 Street.....	14
Table 4a. Future Conditions Results for Receptors North of 53 Avenue.....	15
Table 4b. Future Conditions Results for Receptors West of WMD and South of 53 Avenue.....	16
Table 4c. Future Conditions Residents East of WMD and South of 53 Avenue.....	17
Table 4d. Future Conditions Results for Receptors South of WMD and East Terwillegar Drive.....	18
Table 4e. Future Conditions Results for Receptors North of WMD and West 122 Street.....	19
Table 5. Future Case <i>With</i> Mitigation Noise Modeling Results.....	20
Table 6. Future Case <i>With</i> Noise Wall Option #1 Results (Brander Gardens).....	21
Table 7. Future Case <i>With</i> Noise Wall Option #2 Results (Brander Gardens).....	22
Table 8. Future Case <i>With</i> Noise Wall Option #1 Results (Brookside).....	23
Table 9. Future Case <i>With</i> Noise Wall Option #2 Results (Brookside).....	24

List of Figures

Figure 1. Study Area (Northern Section).....	27
Figure 2. Noise Monitor at Location 1.....	28
Figure 3. Noise Monitor at Location 2.....	28
Figure 4. Noise & Weather Monitor at Location 3.....	29
Figure 5. Noise Monitor at Location 4.....	29
Figure 6. 24-Hour Broadband A-Weighted L_{eq} Sound Levels at Monitor Location 1.....	30
Figure 7. 24-Hour 1/3 Octave Band L_{eq} Sound Levels at Monitor Location 1.....	30
Figure 8. 24-Hour Broadband A-Weighted L_{eq} Sound Levels at Monitor Location 2.....	31
Figure 9. 24-Hour 1/3 Octave Band L_{eq} Sound Levels at Monitor Location 2.....	31
Figure 10. 24-Hour Broadband A-Weighted L_{eq} Sound Levels at Monitor Location 3.....	32
Figure 11. 24-Hour 1/3 Octave Band L_{eq} Sound Levels at Monitor Location 3.....	32
Figure 12. 24-Hour Broadband A-Weighted L_{eq} Sound Levels at Monitor Location 4.....	33
Figure 13. 24-Hour 1/3 Octave Band L_{eq} Sound Levels at Monitor Location 4.....	33
Figure 14a. Current Conditions $L_{eq}24$ Sound Levels for Entire Study Area.....	34
Figure 14b. Current Conditions $L_{eq}24$ Sound Levels (North of 53 Avenue).....	35
Figure 14c. Current Conditions $L_{eq}24$ Sound Levels (South of 53 Avenue).....	36
Figure 14d. Current Conditions $L_{eq}24$ Sound Levels (East of Terwillegar Drive).....	37
Figure 14e. Current Conditions $L_{eq}24$ Sound Levels (West of 122 Street).....	38
Figure 15a. Future Conditions $L_{eq}24$ Sound Levels for Entire Study Area.....	39
Figure 15b. Future Conditions $L_{eq}24$ Sound Levels (North of 53 Avenue).....	40
Figure 15c. Future Conditions $L_{eq}24$ Sound Levels (South of 53 Avenue).....	41
Figure 15d. Future Conditions $L_{eq}24$ Sound Levels (East of Terwillegar Drive).....	42
Figure 15e. Future Conditions $L_{eq}24$ Sound Levels (West of 122 Street).....	43
Figure 16. Ramsey Heights Noise Mitigation $L_{eq}24$ Sound Levels.....	44
Figure 17. Noise Wall Options (Brander Gardens & Brookside).....	45
Figure 18. Noise Wall Option #1 $L_{eq}24$ Sound Levels (Brander Gardens & Brookside).....	46
Figure 19. Noise Wall Option #2 $L_{eq}24$ Sound Levels (Brander Gardens & Brookside).....	47

1.0 Introduction

aci Acoustical Consultants Inc., of Edmonton AB, was retained by CIMA + to conduct an environmental noise impact assessment for the Terwillegar Drive Stage 2 Preliminary Design and Delivery Project (the Project) in Edmonton, Alberta. The purpose of the work was to conduct 24-hour environmental noise monitoring at various locations adjacent to the roadways which were then used to enhance a computer noise model of the study area under current and future traffic conditions. This was then used to determine the noise attenuation measures required to meet the criteria of the City of Edmonton Urban Traffic Noise Policy (UTNP), C506A. Site work was conducted for aci in April 2021 by P. Froment, B.Sc., B.Ed., P.L.(Eng.).

2.0 Location Description

2.1. Study Area Description

The study area for this project includes Whitemud Drive from the North Saskatchewan River to 122 Street as shown in [Figure 1](#). Starting in the north, the study area begins at the North Saskatchewan River where Whitemud Drive crosses the river over Quesnell Bridge before intersecting with Fox Drive. It then continues south up the hill before arriving at the 53 Avenue overpass. Continuing south, Whitemud Drive meets with Terwillegar Drive with various on/off-ramps that is accommodated by various bridges and overpasses. To the east, Whitemud Drive drops in elevation before passing over the Rainbow Valley Bridge and then travels up the hill to 122 Street, which is the southeasternmost portion of the study area. The posted speed limit for Whitemud Drive throughout the study area is 80 km/hr. Other major roadways included in the model are:

- Fox Drive
- 53 Avenue
- Terwillegar Drive
- 122 Street

2.2. Adjacent Development

Starting in the northern-most portion of the study area, the adjacent development to Whitemud Drive between Fox Drive and 53 Avenue consists primarily of single-family residential dwellings. Immediately north of 53 Avenue on either sides of Whitemud Drive are schools (Brookside School on the east and St. Monica School on the west).

Southeast of 53 Avenue and Whitemud Drive is a church and temple, otherwise all other development backing/siding/fronting onto Whitemud Drive is primarily single-family residential dwellings. Dwellings to the east of Whitemud Drive in this area, have back-alley access prior to a natural buffer between it and Whitemud Drive. Southwest of 53 Avenue and Whitemud Drive, development is a mix of multi- and single-family residential dwellings.

Development within proximity to Terwillegar Drive (west & east) and south and north of Whitemud Drive, is again primarily single-family residential dwellings. North of Whitemud Drive as it approaches Rainbow Valley Bridge is the Snow Valley Ski Club while south of Whitemud Drive there is no commercial or residential development (there currently are walking paths along Whitemud Creek.)

West of 122 Street and north of Whitemud Drive is a mix of multi-family residential dwellings and single-family residential dwellings while south of Whitemud Drive in this area are multi-family residential dwellings.

2.3. Topography & Vegetation

Topographically, Whitemud Drive varies significantly in elevation with significant changes between the North Saskatchewan River and 53 Avenue and again between Terwillegar Drive, Rainbow Valley Bridge and 122 Street. The only area that remains relatively flat is between 53 Avenue and Terwillegar Drive. Relative to the Whitemud Drive, residential dwellings within the entire study area are elevated when compared to the road elevations.

Throughout the study area, the ground directly adjacent to Whitemud Drive is covered with field grasses and small patches of trees and bushes and thus does not provide a significant amount of vegetative absorption. The only area in which there is a significant amount of vegetation is in the northern portion of the study area for residents within the Brander Gardens and Brookside communities.

2.4. Existing Noise Mitigation

2.4.1. Northwest Barrier

There is an existing 3.0 m masonry noise barrier on the west side of Whitemud Drive SB between 53 Avenue and Fox Drive. The barrier starts approximately 400 m north of 53 Avenue and continues for approximately 520 m north before terminating.

2.4.2. Southeast Barriers

There are existing masonry noise barriers on the south and north sides of Whitemud Drive, between Rainbow Valley Bridge and 122 Street. The barrier on the south side of Whitemud Drive is approximately 3.0 m tall throughout and starts approximately 240 m west of 122 Street. The barrier continues east for approximately 200 m before it reduces in height to 1.5 m for another 15 m.

The barrier on the north side of Whitemud Drive ranges in height from approximately 2.44 m to 6.5 m (the western portion of the barrier is significantly taller due to the decrease in elevation). The barrier starts approximately 450 m west of 122 Street and continues east for approximately 355 m before slowly lowering and terminating.

2.5. Future Changes within Study Area

The future plans for the roads within the study area include the following:

- Whitemud Drive / Terwillegar Drive interchange upgrades (ramp upgrades, transit priority measures)
- Whitemud Drive upgrades between Fox Drive and 122 Street (roadway widening, transit priority measures)
- Rainbow Valley Bridges Rehabilitation and Widening (major bridge rehabilitation, widening to four lanes in each direction, active mode upgrades)
- Pedestrian/Cyclist Bridge over Whitemud Drive.

3.0 Measurement & Modeling Methods

3.1. Environmental Noise Monitoring

As part of the study, a 24-hour environmental noise monitoring was conducted at four (4) different locations within the study area. The noise monitoring locations, as indicated in [Figure 1](#) were selected based on the results of the concept design work that identified a few locations that were projected to be close to or above the permissible sound levels under future conditions. The results of the noise monitoring were used as a calibration tool for this noise impact assessment.

The noise measurements were conducted collecting broadband A-weighted as well as 1/3 octave band sound levels. This enabled a detailed analysis of the noise climate. The noise monitoring was conducted on weekdays under “typical” traffic conditions. In particular, measurements avoided any holidays, major construction activity that would re-route traffic nearby, and other occurrences which would affect the normal traffic on the road. In addition, the monitoring was conducted in summer-like conditions (i.e. no snow cover) with dry road surfaces and no precipitation. The monitoring was accompanied by a 24-hour digital audio recording for more detailed post process analysis. Finally, a portable weather monitor was used within the study area (at Noise Monitor Location 4) to obtain local weather conditions for all noise monitoring periods.

All noise measurement instrumentation was calibrated at the start of the measurements and then checked afterwards to ensure that there had been no calibration drift over the duration of the measurements. Refer to [Appendix I](#) for a detailed description of the measurement equipment used and calibration records and certificates, [Appendix II](#) for a description of the acoustical terminology, and [Appendix III](#) for a list of common noise sources.

3.1.1. Noise Monitoring Location Description

Noise Monitor 1

Noise Monitor 1 was located approximately 35 m west of Whitemud Drive SB and 20 m southeast of 47a Avenue as shown in [Figure 1](#) and [Figure 2](#). This placed the noise monitor approximately 5 m west of the back-property line at 4730 147a Street. The noise monitor had direct line-of-sight to Whitemud Drive. The noise monitoring data for this location was taken from 18:00 on Monday April 19 to 18:00 on Tuesday April 20, 2021 (entire 24-hour period).

Noise Monitor 2

Noise Monitor 2 was located approximately 35 m west of Whitemud Drive SB and 160 m north of 45 Avenue as shown in [Figure 1](#) and [Figure 3](#). This placed the noise monitor approximately 1 m west of the back-property line at 4615 147a Street. The noise monitor had direct line-of-sight to Whitemud Drive. The noise monitoring data for this location was taken from 18:00 on Monday April 19 to 18:00 on Tuesday April 20, 2021 (entire 24-hour period).

Noise Monitor 3

Noise Monitor 3 was located approximately 65 m west of Whitemud Drive SB and 25 m south of 45 Avenue as shown in [Figure 1](#) and [Figure 4](#). The noise monitor did not have direct line-of-sight to Whitemud Drive due to a moderate earth berm to the east. Therefore the contributions from Whitemud Drive were shielded at this location. The noise monitoring data for this location was taken from 22:00 on Wednesday April 21 to 22:00 on Thursday April 22, 2021 (entire 24-hour period).

Noise Monitor 4

Noise Monitor 4 was located approximately 60 m south of Whitemud Drive EB and 260 m east of the Terwillegar Drive NB to Whitemud Drive EB off-ramp as shown in [Figure 1](#) and [Figure 5](#). This placed the noise monitor approximately 5 m east of the back/side-property line at 931 Burrows Crescent. In addition, it should be noted that this location is significantly higher in elevation than Whitemud Drive (approximately 12 m), thus further reducing its visibility to the roadway. The noise monitoring data for this location was taken from 22:00 on Monday April 26 to 22:00 on Tuesday April 27, 2021 (entire 24-hour period).

4.0 Computer Noise Modeling

The computer noise modeling was conducted using the CADNA/A (Version 2021 MR1, build: 183.5110) software package. CADNA/A allows for the modeling of various noise sources such as road, rail, and various stationary sources. In addition, topographical features such as land contours, vegetation, and bodies of water can be included. Finally, meteorological conditions such as temperature, relative humidity, wind-speed and wind-direction can be included in the calculations.

The default calculation method for traffic noise in CADNA/A follows the German Standard RLS-90. It is aci's experience that this calculation method is accurate under the conditions present for this study, with a tendency to slightly over-predict potential noise levels (i.e. resulting in conservative values). The calculation method used for noise propagation follows the ISO standard 9613-2. All receiver locations were assumed as being downwind from the source(s). In particular, as stated in Section 5 of the ISO document:

“Downwind propagation conditions for the method specified in this part of ISO 9613 are as specified in 5.4.3.3 of ISO 1996-2:1987, namely

- *wind direction within an angle of $\pm 45^{\circ}$ of the direction connecting the centre of the dominant sound source and the centre of the specified receiver region, with the wind blowing from source to receiver, and*
- *wind speed between approximately 1 m/s and 5 m/s, measured at a height of 3 m to 11 m above the ground.*

The equations for calculating the average downwind sound pressure level LAT(DW) in this part of ISO 9613, including the equations for attenuation given in clause 7, are the average for meteorological conditions within these limits. The term average here means the average over a short time interval, as defined in 3.1.

These equations also hold, equivalently, for average propagation under a well-developed moderate ground-based temperature inversion, such as commonly occurs on clear, calm nights”.

4.1.1. Noise Modeling Scenarios

As part of the study, various scenarios were modeled including:

- 1) **Current Case:** This scenario included existing road configurations, alignments, and traffic volumes reflective of the monitoring period (April 2021). The baseline noise monitoring was used as a calibration method for the model.
- 2) **Future Case:** This scenario included final design road configurations, alignments, and projected traffic volumes reflective of the 2050 traffic horizon.
- 3) **Mitigation Case:** This scenario included final design road configurations, alignments, and projected traffic volumes reflective of the 2050 traffic horizon with the addition of noise mitigation in the form of noise barriers. One option was provided for residents within Ramsey Heights while two options were provided for the Brander Gardens and Brookside communities.

4.1.2. Noise Modeling Parameters

Throughout the study area, the ground was given an absorption coefficient of 0.5. Field grasses were added where appropriate to match existing conditions in addition to providing a calibration of the modeled results compared to the measured results at the various noise monitoring locations. Therefore, all sound level propagation calculations are considered conservatively representative of summertime conditions for all surrounding residents.

Residential buildings were included in the model, however not all commercial buildings were included. Receptors were only placed in the first rows of perimeter development in the private backyard space (as required by the UTNP C506A). The exact dimensions and locations of existing structures were not known, so approximate, conservative dimensions were used.

Digital topographical information (in the form of elevation contours) representing the study area, including all interchanges, intersections, off/on-ramps, etc. were included in the noise model.

Traffic volumes on Whitemud Drive, Fox Drive, 53 Avenue, Terwillegar Drive, and 122 Street and all other major roads adjacent to Whitemud Drive were obtained from the City of Edmonton and are reflective of existing¹ and future (2050) traffic projections.

The computer noise modeling results were calculated in two ways. First, sound levels were calculated at specific receptor locations (i.e. typical residential outdoor amenity spaces). This was done at a height of 1.5 m (from the ground) and at a 5 m offset from the back/side property line of for all locations. The projected noise levels at the receptor locations provide a more representative indication of the typical noise levels experienced by residents in their private backyard space (i.e. not directly adjacent to the rear property line). In addition, the use of specific receptor locations allows for a better comparative evaluation of noise levels (e.g. current vs future noise levels, anticipated performance of any noise mitigation measures, if required, etc.)

Secondly, color noise contours were calculated using a 4 m x 4 m grid over the entire study area at a height of 1.5 m. The color noise contours are used to determine if and where noise mitigation is required as they illustrate the projected noise levels within the entire residential private back yard spaces. They are then used once mitigation is in place in order to ensure that all areas within the residential private back yard spaces are below the applicable criteria.

Refer to [Appendix IV](#) for a list of the noise modeling parameters.

4.2. Modeling Confidence

The algorithms used for the noise modeling follow the ISO 9613 standard. The published accuracy for this standard is ± 3 dBA between 100 m – 1,000 m. Accuracy levels beyond 1,000 m are not published. Experience based on similar noise models conducted over large distances shows that, as expected, as the distance increases, the associated accuracy in prediction decreases. Experience has shown that environmental factors such as wind, temperature inversions, topography and ground cover all have increasing effects over distances larger than approximately 1,500 m.

¹ These values included data from traffic counters during the noise monitoring period and from historical data corrected for lower volumes due to Covid-19.

5.0 Permissible Sound Levels

Environmental noise levels from roads are commonly described in terms of equivalent sound levels or L_{eq} . This is the level of a steady sound having the same acoustic energy, over a given time period, as the fluctuating sound. In addition, this energy averaged level is A-weighted to account for the reduced sensitivity of average human hearing to low frequency sounds. These L_{eq} in dBA, which are the most common environmental noise measure, are often given for day-time (07:00 to 22:00) L_{eqDay} and night-time (22:00 to 07:00) $L_{eqNight}$ while other criteria use the entire 24-hour period as L_{eq24} .

The criteria used to evaluate the road noise in the study area include the City of Edmonton Urban Traffic Noise Policy (UTNP), C506A. The UTNP is applicable to residential land use adjacent to major transportation facilities such as arterial roadways, light rail transit and future high-speed transit facilities. The UTNP accounts for “background” transportation noise only and does not deal with non-typical events such as loud mufflers, stereos, etc. These are dealt with under the City of Edmonton Community Standards Bylaw 14600. The following is taken directly from the UTNP:

- 1) A 20-year¹ time horizon for traffic volume projections (AAWDT volumes) is used to predict future noise levels adjacent to new developments and new or upgraded transportation facilities.
- 2) The City of Edmonton will seek to ensure that no new residential development less than three storeys will be allowed adjacent to transportation facilities (arterial roadways, light rail transit) unless the developer proves to the satisfaction of the City that the projected noise level in the private back yards of residences abutting the transportation facility will not exceed 65 dBA L_{eq24} . Construction of any noise attenuation measures necessary to achieve this threshold will be funded and undertaken by the developer of the adjacent property, unless specific site characteristics, such as topography or existing land uses, necessitate the consideration of relief from the requirement. Under these circumstances, the attenuated noise level in the abutting private back yards should be the lowest level technically and economically practicable.

In summary, the UTNP requires a maximum sound level of 65 dBA L_{eq24} of for all dwellings less than 3 storeys. As such, the **permissible sound level (PSL) for the area is 65 dBA L_{eq24} .**

¹As previously mentioned, 2050 data was provided used in the model.

6.0 Noise Monitoring Results

6.1. Noise Monitoring

The results obtained from the environmental noise monitoring are provided in Table 1 and [Figures 6 - 13](#) (broadband A-weighted L_{eq} sound levels and 1/3 octave band L_{eq} sound levels provided). For the purposes of the data analysis, one (1) 24-hour time period was investigated for each location. The 24-hour time period was selected based on a review of the weather conditions (favorable for the noise to propagate from the major roadway to the noise monitor). It should be noted that the data have been adjusted by the removal of non-typical noise events such as loud aircraft flyovers (the noise modeling does not account for aircraft), pedestrians, dogs making noise nearby, abnormally loud vehicle passages, etc. A list of all non-typical noise events removed from each of the noise monitoring locations can be found in [Appendix V](#).

Table 1. 2021 Noise Monitoring Results

Monitoring Location	Date	Leq24 (dBA)	LeqDay (dBA)	LeqNight (dBA)
M1	April 19 - 20, 2021 (18:00 – 18:00)	66.0	67.0	63.4
M2	April 19 - 20, 2021 (18:00 – 18:00)	68.9 (65.9 ¹)	70.0	66.0
M3	April 21 - 22, 2021 (22:00 – 22:00)	52.8	53.0	52.3
M4	April 26 - 27, 2021 (22:00 – 22:00)	54.9	55.9	52.7

The results from the noise monitoring indicate L_{eq24} noise levels ranging from 52.8 dBA to 68.9 dBA, however it should be noted that M1 & M2 had direct line-of-sight to Whitemud Drive SB (thus resulting in relatively high noise levels). Additionally, it was noted that the reflections from the residential fence directly adjacent to M2 would result in the “façade effect¹” thus increasing the measured noise levels by 3 dBA.

At all locations, the resultant 1/3 octave band L_{eq} sound levels were very similar with the typical trend of low frequency noise (near 63 – 80 Hz) resulting from engines and exhaust, as well as mid-high frequency noise (near 1,000 Hz) resulting from tire noise. These results confirm that the noise levels being measured by the noise monitors were largely attributed to Whitemud Drive and/or other major roadways within proximity to the noise monitors.

¹ The façade effect is essentially the reflection of sound from a nearby façade, or in this case a fence. The result is a doubling of the acoustic energy being measured by the microphone, which results in an increase of 3 dBA. Thus it would be anticipated that the L_{eq24} measured noise levels at M2, with the absence of the fence, be 65.9 dBA. This will be further explored in [Section 7.1](#).

6.2. Weather Conditions

As previously mentioned, a local weather monitoring station was used throughout the entire noise monitoring period to obtain the wind speed, wind direction, temperature & relative humidity data in 1-minute sampling periods. All weather data are presented in [Appendix VI](#).

For Noise Monitor 1 & 2 (18:00 – 18:00 on April 19 - 20, 2021) the wind was moderate to low throughout and ranged in directions but primarily caused downwind conditions for M1 & M2, which is ideal. The temperature ranged from -4°C to 13°C and the relative humidity ranged from approximately 20% - 74%.

The weather conditions for Noise Monitor 3 (22:00 – 22:00 on April 21 - 22, 2021) had a wind that was primarily from the northwest (resulting in crosswind conditions). The wind was moderate to high (above 10 km/hr) throughout the entire monitoring period, which likely resulted in worst case conditions for residents to the southeast of the Whitemud Drive & Terwillegar Drive interchange. The temperature ranged from -4°C to 18°C and the relative humidity ranged from approximately 18% - 76%.

For Noise Monitor 4 (22:00 – 22:00 on April 26 - 27, 2021) the wind was moderate to low throughout and was primarily from the north (Northeast to northwest) which made M4 downwind from Whitemud Drive, which is ideal. The temperature ranged from -2°C to 13°C and the relative humidity ranged from approximately 20% - 74%.

7.0 Noise Modelling Results

7.1. Current Conditions

7.1.1. Monitoring Locations

The L_{eq24} sound levels from the noise modeling under current conditions at the noise monitoring locations are presented in Table 2. In addition, the difference relative to the monitoring results at each location has been provided. In general, the modeled sound levels compare well with the monitored results at each location. As previously mentioned, when considering the “façade effect” for M2, the measured values compare very closely to the modeled values. As a result, the modeling values are considered representative of the current noise levels of the noise climate of this area.

Table 2. Noise Modeling Results Under Current Conditions at Monitor Locations

Monitor	Monitoring Results Leq24 (dBA)	Modeling Results Leq24 (dBA)	Difference Relative to Monitor Results L_{eq24} (dBA)
M1	66.0	65.7	-0.3
M2	68.9 (65.9 ¹)	65.7	-3.2 (-0.2 ¹)
M3	52.8	53.0	0.2
M4	54.9	54.9	0.0

7.1.2. Residential Receptor Locations

The results of the Current Conditions noise modeling at the various residential property locations are presented in Tables 3a – 3e. The study area was divided into separate groups for easier reference. In addition to the information presented in Tables 3a – 3e, the L_{eq24} color noise contours for the entire study area are shown in [Figures 14a – 14e](#). The color noise contours provide a good representation of where the “hot” spots are (in terms of elevated noise levels) and the relative contribution from each of the nearby roadways for the various receptor locations. In the event of a discrepancy between the results indicated in the color contours and the Tables, the Tables will be considered as correct because the calculation locations in the Tables are at exact coordinates while the color contours are calculated on a 4 m x 4m grid and the results elsewhere are interpolated.

Apart from two locations (R-01 & R-02), the current noise levels at all receptor locations are under the limit of 65 dBA L_{eq24} and range from 51.9 dBA to 66.1 dBA.

¹ Values in brackets account for façade effect.

Table 3a. Current Conditions Results for Receptors North of 53 Avenue

Receptor	L _{eq} 24 (dBA)	Receptor	L _{eq} 24 (dBA)
R-01	65.7	R-16	62.1
R-02	66.1	R-17	63.2
R-03	62.7	R-18	63.2
R-04	64.8	R-19	63.7
R-05	63.1	R-20	64.0
R-06	63.0	R-21	63.3
R-07	59.3	R-22	61.3
R-08	58.7	R-23	59.0
R-09	54.8	R-24	57.1
R-10	56.8	R-25	56.6
R-11	57.0	R-26	57.4
R-12	57.9	R-27	57.4
R-13	57.7	R-28	57.3
R-14	59.8	R-29	57.3
R-15	60.7	R-30	57.3
Min	54.8	Max	66.1

Table 3b. Current Conditions Results for Receptors West of WMD and South of 53 Avenue

Receptor	L _{eq} 24 (dBA)
R-31	62.5
R-32	62.4
R-33	63.0
R-34	64.0
R-35	64.0
R-36	64.0
R-37	63.9
R-38	62.8
R-39	62.1
R-40	61.5
R-41	58.5
R-42	54.5
R-43	54.1
R-44	53.4
R-45	52.2
R-46	51.9
Min	51.9
Max	64.0

Table 3c. Current Conditions Results for Residents East of WMD and South of 53 Avenue

Receptor	L _{eq} 24 (dBA)	Receptor	L _{eq} 24 (dBA)
R-47	60.3	R-57	57.1
R-48	60.3	R-58	57.2
R-49	59.7	R-59	56.6
R-50	58.8	R-60	57.0
R-51	57.8	R-61	58.5
R-52	57.6	R-62	57.3
R-53	57.9	R-63	56.5
R-54	57.4	R-64	56.9
R-55	57.0	R-65	54.1
R-56	57.5	R-66	55.7
Min	54.1	Max	60.3

Table 3d. Current Conditions Results for Residents South of WMD and East of Terwillegar Drive

Receptor	L _{eq} 24 (dBA)	Receptor	L _{eq} 24 (dBA)
R-67	57.1	R-76	58.6
R-68	58.3	R-77	57.3
R-69	57.9	R-78	57.2
R-70	58.5	R-79	57.2
R-71	57.0	R-80	56.4
R-72	57.1	R-81	59.5
R-73	58.2	R-82	60.2
R-74	58.3	R-83	61.0
R-75	57.0		
Min	56.4	Max	61.0

Table 3e. Current Conditions Results for Residents North of WMD and West of 122 Street

Receptor	L _{eq} 24 (dBA)
R-84	51.6
R-85	57.0
R-86	60.6
R-87	60.0
R-88	59.2
Min	51.6
Max	60.6

7.2. Future Conditions

The results of the noise modeling under future conditions (Year 2050) at the residential receptor locations are presented in Tables 4a – 4e and shown in [Figures 15a – 15e](#). The L_{eq24} sound levels are presented in the Tables along with the relative increase compared to the L_{eq24} Current conditions. As with the Current Conditions, in the event of a discrepancy between the results indicated in the color contours and the Tables, the Tables will be considered as correct. Below each Table is a summary discussion of the results for that specific area.

Table 4a. Future Conditions Results for Receptors North of 53 Avenue

Receptor	L_{eq24} (dBA)	Difference Relative to Current Case L_{eq24} (dBA)	Receptor	L_{eq24} (dBA)	Difference Relative to Current Case L_{eq24} (dBA)
R-01	67.0	1.3	R-16	64.5	2.4
R-02	67.3	1.2	R-17	66.1	2.9
R-03	64.1	1.4	R-18	65.5	2.3
R-04	65.6	0.8	R-19	65.6	1.9
R-05	64.2	1.1	R-20	65.8	1.8
R-06	64.2	1.2	R-21	64.9	1.6
R-07	60.6	1.3	R-22	62.9	1.6
R-08	60.0	1.3	R-23	61.1	2.1
R-09	55.9	1.1	R-24	61.0	3.9
R-10	58.0	1.2	R-25	61.1	4.5
R-11	58.5	1.5	R-26	62.5	5.1
R-12	59.6	1.7	R-27	62.5	5.1
R-13	59.7	2.0	R-28	62.1	4.8
R-14	60.8	1.0	R-29	61.4	4.1
R-15	61.8	1.1	R-30	61.0	3.7
Min	55.9	0.8	Max	67.3	5.1

The Future Conditions noise modeling results for residents north of 53 Avenue indicated noise levels ranging from 55.9 dBA – 67.3 dBA L_{eq24} at all locations. The increases relative to the Current Conditions ranged from +0.8 to +5.1 dBA which were primarily due to the expansion of Whitemud Drive and to projected increases in traffic volumes on Whitemud Drive. As indicated in Table 4a and [Figure 15b](#) Receptors R-01 – R-06 & R-16 – R-21 are projected to have future L_{eq24} noise levels above 65 dBA in their backyard space. As such, these receptors will require noise mitigation as per the requirements of the City of Edmonton UTNP C506A.

Table 4b. Future Conditions Results for Receptors West of WMD and South of 53 Avenue

Receptor	L _{eq} 24 (dBA)	Difference Relative to Current Case Leq24 (dBA)
R-31	63.9	1.4
R-32	64.1	1.7
R-33	64.7	1.7
R-34	65.1	1.1
R-35	65.6	1.6
R-36	65.5	1.5
R-37	65.6	1.7
R-38	63.9	1.1
R-39	63.0	0.9
R-40	62.5	1.0
R-41	60.6	2.1
R-42	58.4	3.9
R-43	57.4	3.3
R-44	56.8	3.4
R-45	55.9	3.7
R-46	55.5	3.6
Min	55.5	0.9
Max	65.7	3.9

The Future Conditions noise modeling results for residents west of Whitemud Drive and south of 53 Avenue indicated noise levels ranging from 55.5 dBA – 65.7 dBA L_{eq}24 at all locations. The increases relative to the Current Conditions ranged from +0.9 to +3.9 dBA which were due to the projected increases in traffic volumes and the widening/re-alignment of Whitemud Drive.

As indicated in Table 4b or as illustrated in [Figure 15c](#), Receptors R-34 – R-39 (between 47a Avenue and 45 Avenue) have future L_{eq}24 noise levels that are projected to be above 65 dBA in their backyard space. As such, these receptors¹ will require noise mitigation as per the requirements of the City of Edmonton UTNP C506A.

¹ Due to continuity of the noise barrier, the noise mitigation will be extended to the residence immediately north of the walkway at 45 Avenue.

Table 4c. Future Conditions Residents East of WMD and South of 53 Avenue

Receptor	L _{eq} 24 (dBA)	Difference Relative to Current Case Leq24 (dBA)	Receptor	L _{eq} 24 (dBA)	Difference Relative to Current Case Leq24 (dBA)
R-47	61.8	1.5	R-57	61.8	4.7
R-48	61.8	1.5	R-58	61.4	4.2
R-49	61.4	1.7	R-59	60.1	3.5
R-50	61.0	2.2	R-60	58.7	1.7
R-51	60.5	2.7	R-61	61.0	2.5
R-52	60.8	3.2	R-62	59.7	2.4
R-53	61.3	3.4	R-63	59.1	2.6
R-54	61.4	4.0	R-64	57.7	0.8
R-55	61.3	4.3	R-65	56.7	2.6
R-56	61.6	4.1	R-66	57.7	2.0
Min	56.7	0.8	Max	61.8	4.7

The Future Conditions noise modeling results for Residents east/north of Whitemud Drive and south of 53 Avenue indicated noise levels ranging from 56.7 dBA – 61.8 dBA L_{eq}24 at all locations. The increases relative to the Current Conditions ranged from +0.8 to +4.7 dBA. This portion of the study area has the highest increase in noise level which is due to several proposed changes. This includes the re-alignment of the Whitemud Drive 53 Avenue Off-ramp which will i) shift traffic closer to the adjacent residential locations and ii) reduce the existing acoustical shielding provided by the existing earth berm northeast of Whitemud Drive. In addition, the proposed Terwillegar Drive NB lanes will be shifted to the northeast and elevated thus improving sightlines from traffic to the residential locations.

However, since all residential receptor L_{eq}24 noise levels are projected to be below 65 dBA under Future Case conditions, noise mitigation will not be required to meet the requirements of the City of Edmonton UTNP C506A.

Table 4d. Future Conditions Results for Receptors South of WMD and East Terwillegar Drive

Receptor	L _{eq} 24 (dBA)	Difference Relative to Current Case Leq24 (dBA)	Receptor	L _{eq} 24 (dBA)	Difference Relative to Current Case Leq24 (dBA)
R-67	58.4	1.3	R-76	59.3	0.7
R-68	59.2	0.9	R-77	58.7	1.4
R-69	58.2	0.3	R-78	58.9	1.7
R-70	58.9	0.4	R-79	58.9	1.7
R-71	58.2	1.2	R-80	58.2	1.8
R-72	58.8	1.7	R-81	60.0	0.5
R-73	59.1	0.9	R-82	61.4	1.2
R-74	58.4	0.1	R-83	63.0	2.0
R-75	58.7	1.7			
Min	58.2	0.1	Max	63.0	2.0

The Future Conditions noise modeling results for Residents south of Whitemud Drive and east of Terwillegar Drive indicated noise levels ranging from 58.2 dBA – 63.0 dBA L_{eq}24 at all locations. The increases relative to the Current Conditions ranged from +0.1 to +2.0 dBA. For certain locations, there is a minimal increase in the projected noise levels despite the increase in future projected traffic volumes due to the re-alignment of various roads that will move further away from the residents.

All residential receptor L_{eq}24 noise levels within this area are projected to be below 65 dBA under Future Case conditions, as such noise mitigation will not be required as per the requirements of the City of Edmonton UTNP C506A.

Table 4e. Future Conditions Results for Receptors North of WMD and West 122 Street

Receptor	L _{eq} 24 (dBA)	Difference Relative to Current Case Leq24 (dBA)
R-84	53.7	2.1
R-85	59.3	2.3
R-86	62.6	2.0
R-87	62.3	2.3
R-88	61.5	2.3
Min	53.7	2.0
Max	62.6	2.3

The Future Conditions noise modeling results for Residents north of Whitemud Drive and west of 122 Street indicated noise levels ranging from 53.7 dBA – 62.6 dBA L_{eq}24 at all locations. The increases relative to the Current Conditions ranged from +2.0 to +2.3 dBA which were due to the projected increases in traffic volumes and the widening/re-alignment of Whitemud Drive.

All residential receptor L_{eq}24 noise levels within this area are projected to be below 65 dBA under Future Case conditions, as such, additional noise mitigation will not be required as per the requirements of the City of Edmonton UTNP C506A.

7.3. Future Case Conditions with Noise Mitigation

The results of the Future Case noise modeling with noise mitigation will be presented in the following section. It should be noted that only the receptor locations requiring noise mitigation will be discussed. All other locations will have the same projected noise levels found in Tables 4a – 4e. Lastly, each community will be discussed independently.

7.4. Residents in Ramsay Heights

The results of the Future Case noise modeling *with* noise mitigation for residents in the Ramsay Heights community (between 47a Avenue and 45 Avenue) are presented in Table 5 and illustrated in [Figure 16](#). In addition, the relative difference between the Future Case L_{eq24} *with* and *without* mitigation has also been included.

Table 5. Future Case *With* Mitigation Noise Modeling Results

Receptor	Future L_{eq24} (dBA)	Mitigation L_{eq24} (dBA)	Difference Relative to Future Case L_{eq24} (dBA)
R-34	65.1	59.3	-5.8
R-35	65.6	60.1	-5.5
R-36	65.5	59.6	-5.9
R-37	65.7	60.1	-5.6
R-38	63.9	58.1	-5.8
R-39	63.0	58.3	-4.7
R-40	62.5	59.3	-3.2
R-41	60.6	58.9	-1.7
Min	60.6	58.1	-5.9
Max	65.7	60.1	-1.7

As indicated in Table 5 and illustrated in [Figure 16](#), all L_{eq24} noise levels are projected to be below 65 dBA and range from 58.1 – 60.1 dBA for residential receptors with noise mitigation. The relative difference in noise levels for receptors with noise mitigation from the Future case *with* and *without* noise mitigation ranges from -1.7 to -5.9 dBA. Since all residential receptor L_{eq24} noise levels are below 65 dBA throughout the entire backyard spaces, no further noise mitigation will be required to meet the requirements of the City of Edmonton UTNP C506A.

To achieve the noise levels found in Table 5 and [Figure 16](#), a 1.83 m (6 ft) tall barrier is required along the back-property line of the residential locations that back directly onto Whitemud Drive SB from 47a Avenue to 45 Avenue. The barrier must wrap around on the north and south ends by approximately 5 m before terminating. This can be an abrupt termination or a gradual decrease in height.

7.5. Residents in Brander Gardens

This section will be specific to residents in the Brander Gardens community (fronting 145a Street and not currently adjacent to the existing noise barrier). Due to varying topographical and geotechnical features of this area, two mitigation options were investigated. As such, the description and results of each option will be discussed independently.

7.5.1. Noise Wall Option #1

As illustrated in [Figure 17](#), Noise Wall Option #1 (purple line) follows the approximate location of the top of the embankment. The results of the Future Case noise modeling *with* Noise Wall Option #1 are presented in Table 6 and illustrated in [Figure 18](#). In addition, the relative difference between the Future Case L_{eq24} *with* and *without* mitigation has also been included.

Table 6. Future Case With Noise Wall Option #1 Results (Brander Gardens)

Receptor	Future L_{eq24} (dBA)	Mitigation L_{eq24} (dBA)	Difference Relative to Future Case L_{eq24} (dBA)
R-01	67.0	61.0	-6.0
R-02	67.3	61.7	-5.6
R-03	64.1	60.7	-3.4
R-04	65.6	61.3	-4.3
R-05	64.2	60.0	-4.2
R-06	64.2	61.2	-3.0
Min	64.1	60.0	-6.0
Max	67.3	61.7	-3.0

As indicated in Table 6 and illustrated in [Figure 18](#), all L_{eq24} noise levels are projected to be below 65 dBA and range from 60.0 – 61.7 dBA for all residential receptors within this area. The relative difference in noise levels for receptors with noise mitigation from the Future case *with* and *without* noise mitigation ranges from -3.0 to -6.0 dBA. Since all residential receptor L_{eq24} noise levels are below 65 dBA

throughout the entire backyard spaces, no further noise mitigation will be required to meet the requirements of the City of Edmonton UTNP C506A.

To achieve the noise levels found in Table 6 and [Figure 18](#), a 2.44 m (8 ft) tall barrier (relative to the existing elevation along the proposed alignment) is required along the proposed alignment indicated in [Figure 17](#).

7.5.2. Noise Wall Option #2

As illustrated in [Figure 17](#), Noise Wall Option #2 (blue line) follows the back property line of residents backing onto Whitemud Drive SB, from residents at 6315 – 145A Street to 6515 – 145a Street. The results of the Future Case noise modeling *with* Noise Wall Option #2 are presented in Table 7 and illustrated in [Figure 19](#). In addition, the relative difference between the Future Case L_{eq24} *with* and *without* mitigation has also been included.

Table 7. Future Case With Noise Wall Option #2 Results (Brander Gardens)

Receptor	Future L_{eq24} (dBA)	Mitigation L_{eq24} (dBA)	Difference Relative to Future Case L_{eq24} (dBA)
R-01	67.0	58.1	-8.9
R-02	67.3	60.9	-6.4
R-03	64.1	59.9	-4.2
R-04	65.6	61.0	-4.6
R-05	64.2	59.7	-4.5
R-06	64.2	60.2	-4.0
Min	64.1	58.1	-8.9
Max	67.3	61.0	-4.0

As indicated in Table 7 and illustrated in [Figure 19](#), all L_{eq24} noise levels are projected to be below 65 dBA and range from 58.1 – 61.0 dBA for all residential receptors within this area. The relative difference in noise levels for receptors with noise mitigation from the Future case *with* and *without* noise mitigation ranges from -4.0 to -8.9 dBA. Since all residential receptor L_{eq24} noise levels are below 65 dBA throughout the entire backyard spaces, no further noise mitigation will be required to meet the requirements of the City of Edmonton UTNP C506A.

To achieve the noise levels found in Table 7 and [Figure 19](#), a 2.44 m (8 ft) tall barrier (relative to the current ground elevation at the residential dwelling) is required along the proposed alignment as indicated in [Figure 17](#).

7.6. Residents in Brookside

This section will be specific to residents in the Brookside community (fronting 114 Street/63 Avenue). Due to varying topographical and geotechnical features of this area, two mitigation options were investigated. As such, the description and results of each option will be discussed independently.

7.6.1. Noise Wall Option #1

As illustrated in [Figure 17](#), Noise Wall Option #1 (purple line) follows the approximate location of the top of the embankment. The results of the Future Case noise modeling *with* Noise Wall Option #1 are presented in Table 8 and illustrated in [Figure 18](#). In addition, the relative difference between the Future Case L_{eq24} *with* and *without* mitigation has also been included.

Table 8. Future Case *With* Noise Wall Option #1 Results (Brookside)

Receptor	Future L_{eq24} (dBA)	Mitigation L_{eq24} (dBA)	Difference Relative to Future Case L_{eq24} (dBA)
R-14	60.8	56.8	-4.0
R-15	61.8	57.7	-4.1
R-16	64.5	61.2	-3.3
R-17	66.1	63.1	-3.0
R-18	65.5	61.2	-4.3
R-19	65.6	61.2	-4.4
R-20	65.8	61.7	-4.1
R-21	64.9	61.6	-3.3
Min	60.8	56.8	-4.4
Max	66.1	63.1	-3.0

As indicated in Table 8 and illustrated in [Figure 18](#), all L_{eq24} noise levels are projected to be below 65 dBA and range from 56.8 – 63.1 dBA for all residential receptors within this area. The relative difference in noise levels for receptors with noise mitigation from the Future case *with* and *without* noise mitigation ranges from -3.0 to -4.4 dBA. Since all residential receptor L_{eq24} noise levels are below 65 dBA throughout the entire backyard spaces, no further noise mitigation will be required to meet the requirements of the City of Edmonton UTNP C506A.

To achieve the noise levels found in Table 8 and [Figure 18](#), 2.44 m (8 ft) & 3.0 m tall barrier heights (relative to the existing elevation along the proposed alignment) are required along the proposed alignment, as indicated in [Figure 17](#).

7.6.2. Noise Wall Option #2

As illustrated in [Figure 17](#), Noise Wall Option #2 (blue line) follows the back property line of residents backing onto Whitemud Drive SB, from residents at 6004-144 Street to 14808-63 Avenue. The results of the Future Case noise modeling *with* Noise Wall Option #2 are presented in Table 9 and illustrated in [Figure 19](#). In addition, the relative difference between the Future Case L_{eq24} *with* and *without* mitigation has also been included.

Table 9. Future Case *With* Noise Wall Option #2 Results (Brookside)

Receptor	Future L_{eq24} (dBA)	Mitigation L_{eq24} (dBA)	Difference Relative to Future Case L_{eq24} (dBA)
R-14	60.8	59.0	-1.8
R-15	61.8	59.1	-2.7
R-16	64.5	61.5	-3.0
R-17	66.1	62.1	-4.0
R-18	65.5	62.2	-3.3
R-19	65.6	63.1	-2.5
R-20	65.8	63.5	-2.3
R-21	64.9	63.2	-1.7
Min	60.8	59.0	-4.0
Max	66.1	63.5	-1.7

As indicated in Table 9 and illustrated in [Figure 19](#), all L_{eq24} noise levels are projected to be below 65 dBA and range from 59.0 – 63.5 dBA for all residential receptors within this area. The relative difference in noise levels for receptors with noise mitigation from the Future case *with* and *without* noise mitigation ranges from -1.7 to -4.0 dBA. Since all residential receptor L_{eq24} noise levels are below 65 dBA throughout the entire backyard spaces, no further noise mitigation will be required to meet the requirements of the City of Edmonton UTNP C506A.

To achieve the noise levels found in Table 9 and [Figure 19](#), a 1.83 m (6 ft) tall barrier (relative to the existing ground elevation at the current property line) is required along the proposed alignment indicated in [Figure 17](#).

8.0 Conclusion

The results of the Current Conditions noise monitoring indicated noise levels ranging from 52.8 dBA to 68.9 dBA L_{eq24} . All locations showed the typical trend of noise associated with traffic. These results confirmed that the noise levels being measured by the noise monitors were largely attributed to Whitemud Drive, Terwillegar Drive, and/or other major roadways within proximity to the noise monitors.

The noise modeling results for Current Conditions matched well with the noise measurement results for all locations. The Current Conditions modeled noise levels at the existing residential receptor locations ranged from 51.6 – 66.1 dBA. This indicated that certain receptor locations would require noise mitigation as per the requirements of the City of Edmonton UTNP C506A, particularly under future case conditions.

The noise modeling results of all residential receptor locations for the Future Conditions (with projected traffic volumes representative of 2050) indicated noise levels ranging from 53.7 – 67.3 dBA with a relative increase ranging from 0.1 dBA to 5.1 dBA. Since there were residential locations with projected noise levels above 65 dBA, as per the requirements of the City of Edmonton UTNP C506A, these locations were investigated to determine the minimum amount of noise mitigation required to reduce their projected noise levels to below 65 dBA L_{eq24} .

Noise mitigation was investigated for residents within the Ramsey Heights, Brander Gardens and Brookside communities. For residents within Ramsey Heights (between 47a Avenue and 45 Avenue) it was determined that a 1.83 m tall barrier would be required along their back property line. This resulted in projected L_{eq24} noise levels ranging from 58.1 – 60.1 dBA. Two noise wall options were provided for residents within Brander Gardens and Brookside, respectively. The resulting projected L_{eq24} noise levels for Brander Gardens ranged from 60.0 – 61.7 dBA (Wall Option #1) and 58.1 – 61.0 dBA (Wall Option #2), respectively. The resulting projected L_{eq24} noise levels for Brookside ranged from 56.8 – 63.1 dBA (Wall Option #1) and 59.0 – 63.5 dBA (Wall Options #2), respectively.

Since all residential receptor L_{eq24} noise levels are below 65 dBA throughout the entire backyard spaces, no further noise mitigation (apart from options provided within this report) will be required to meet the requirements of the City of Edmonton UTNP C506A.

9.0 References

- City of Edmonton Urban Traffic Noise Policy (C506A), 2013
- City of Edmonton Community Standards Bylaw 14600, 2008
- International Organization for Standardization (ISO), *Standard 1996-1, Acoustics – Description, measurement and assessment of environmental noise – Part 1: Basic quantities and assessment procedures*, 2003, Geneva Switzerland.
- International Organization for Standardization (ISO), *Standard 9613-1, Acoustics – Attenuation of sound during propagation outdoors – Part 1: Calculation of absorption of sound by the atmosphere*, 1993, Geneva Switzerland.
- International Organization for Standardization (ISO), *Standard 9613-2, Acoustics – Attenuation of sound during propagation outdoors – Part 2: General method of calculation*, 1996, Geneva Switzerland.

DRAFT

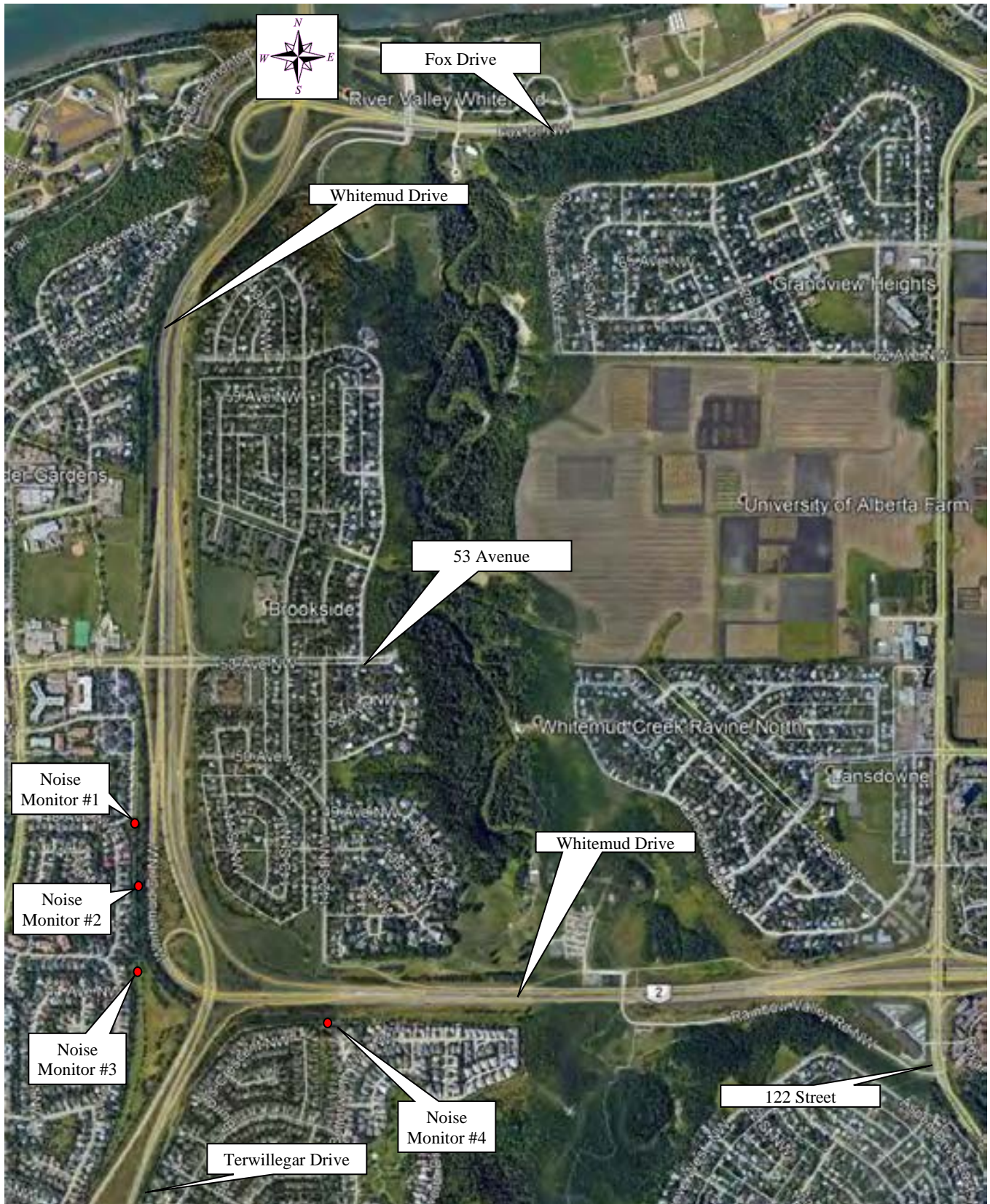

Figure 1. Study Area (Northern Section)

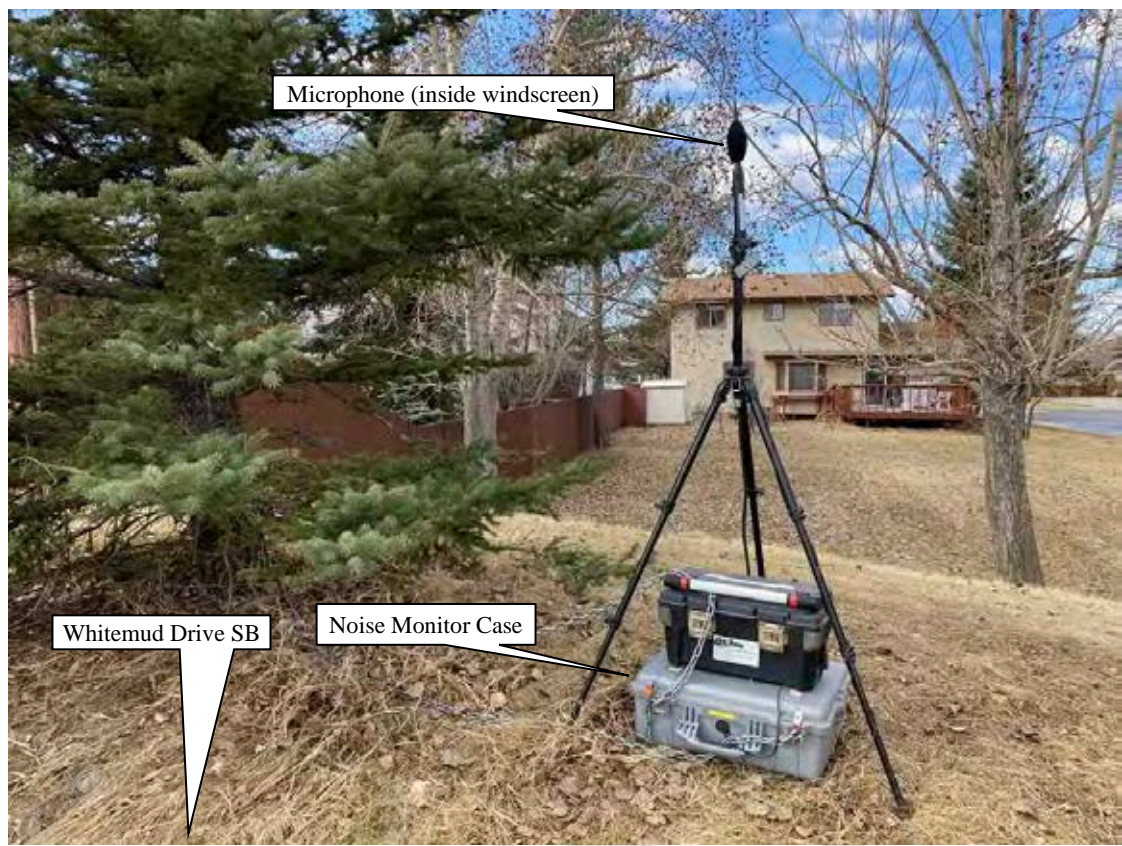

Figure 2. Noise Monitor at Location 1

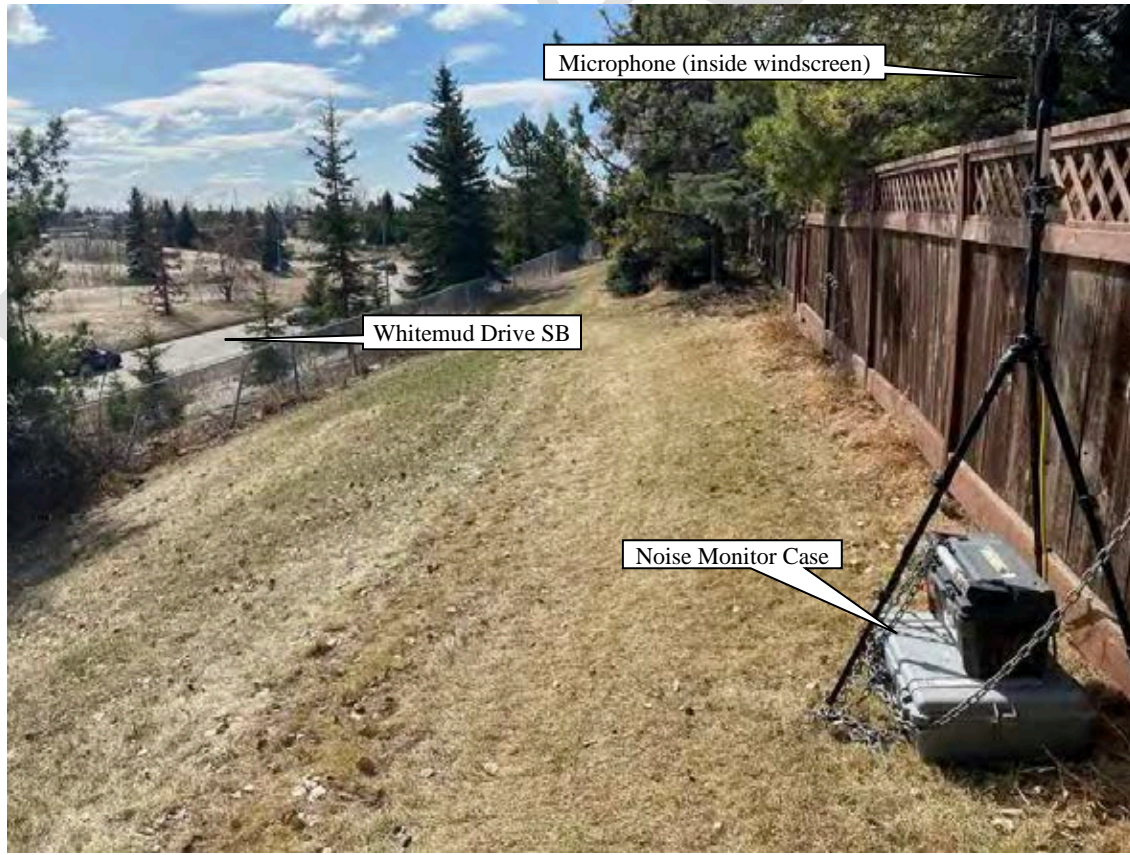

Figure 3. Noise Monitor at Location 2

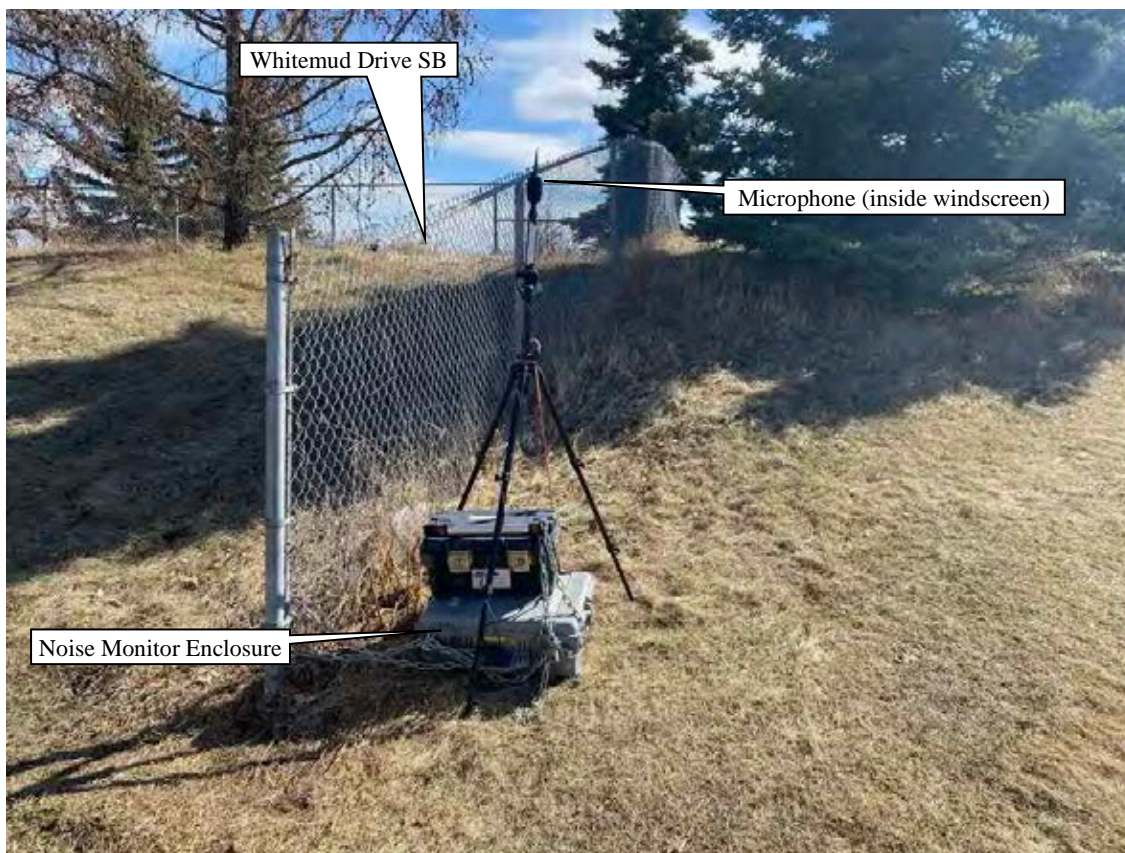

Figure 4. Noise & Weather Monitor at Location 3

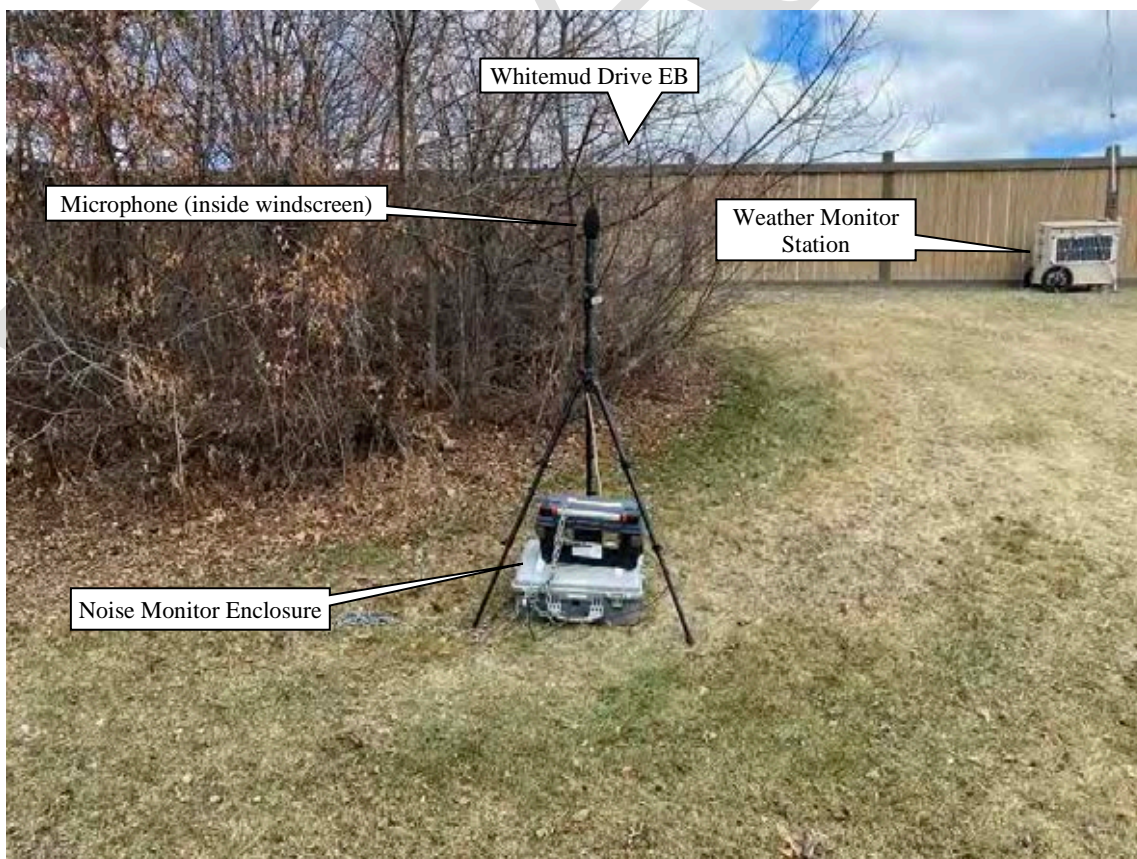

Figure 5. Noise Monitor at Location 4

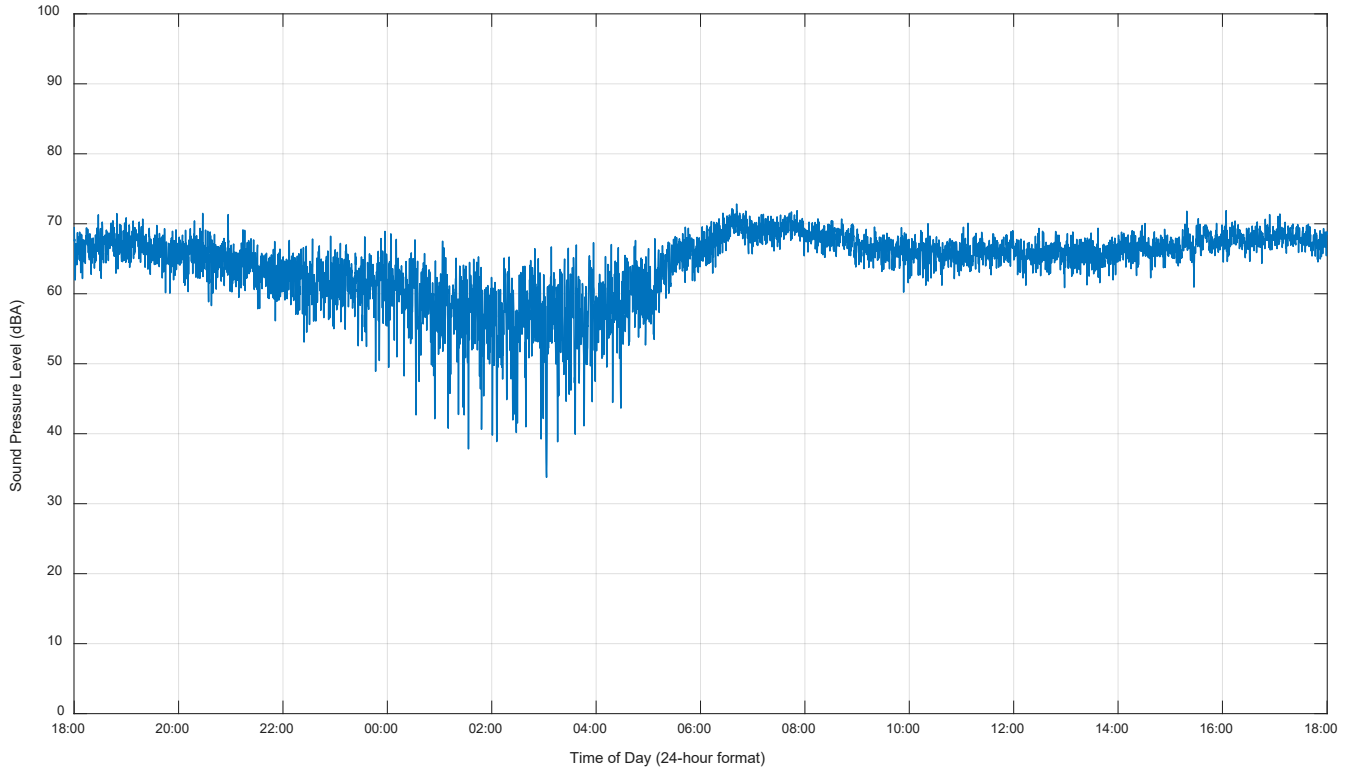

Figure 6. 24-Hour Broadband A-Weighted L_{eq} Sound Levels at Monitor Location 1

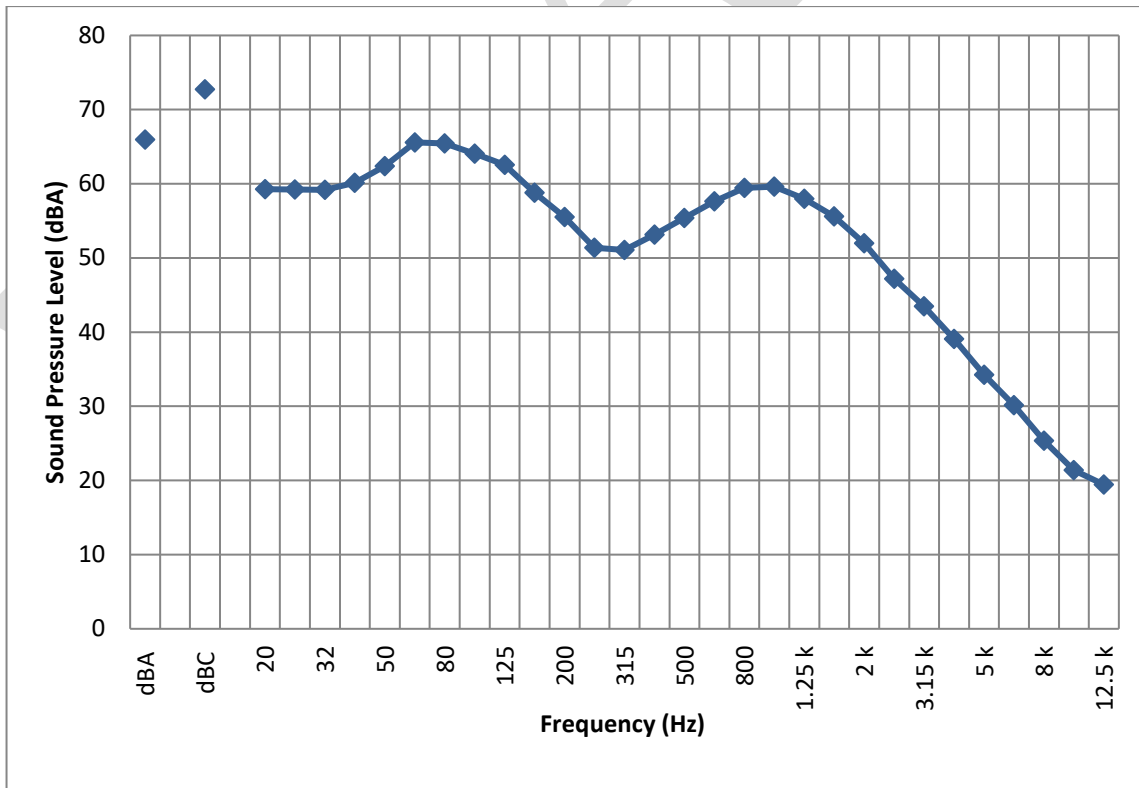

Figure 7. 24-Hour 1/3 Octave Band L_{eq} Sound Levels at Monitor Location 1

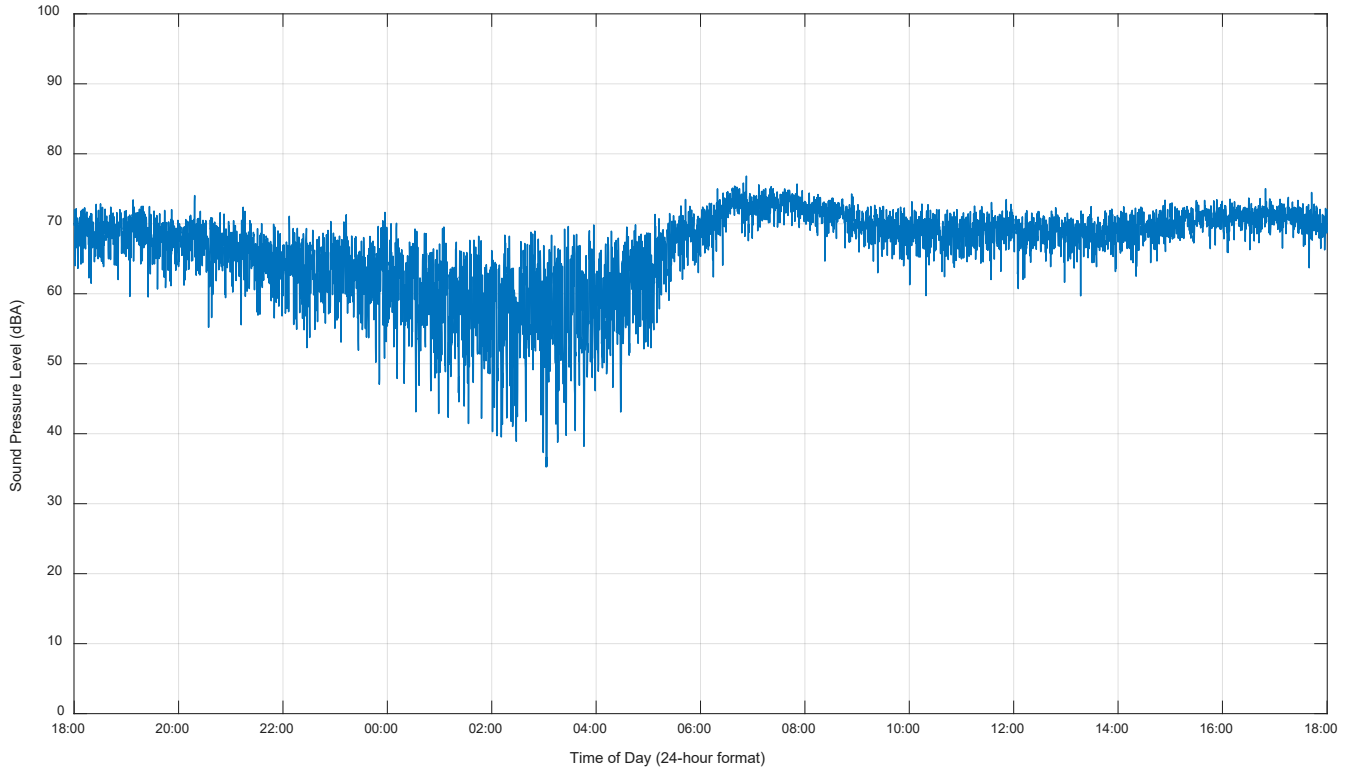

Figure 8. 24-Hour Broadband A-Weighted L_{eq} Sound Levels at Monitor Location 2

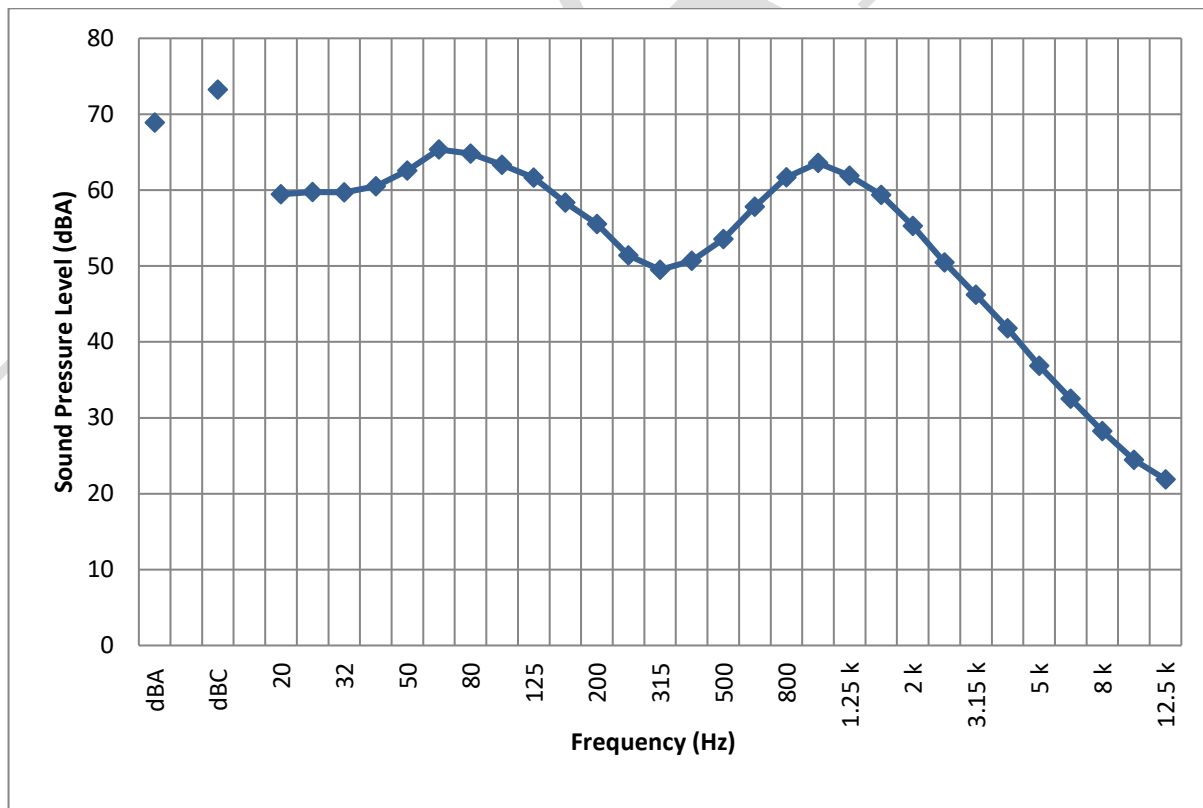

Figure 9. 24-Hour 1/3 Octave Band L_{eq} Sound Levels at Monitor Location 2

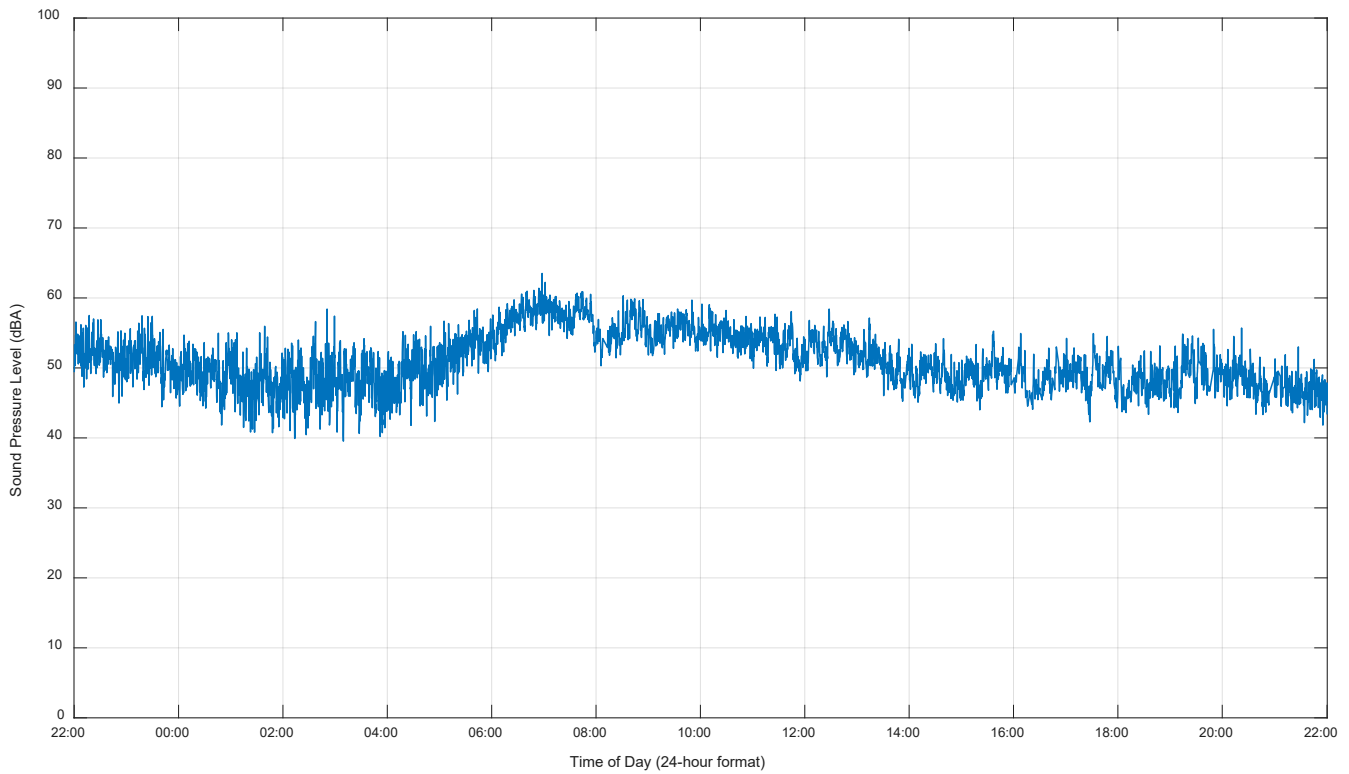

Figure 10. 24-Hour Broadband A-Weighted L_{eq} Sound Levels at Monitor Location 3

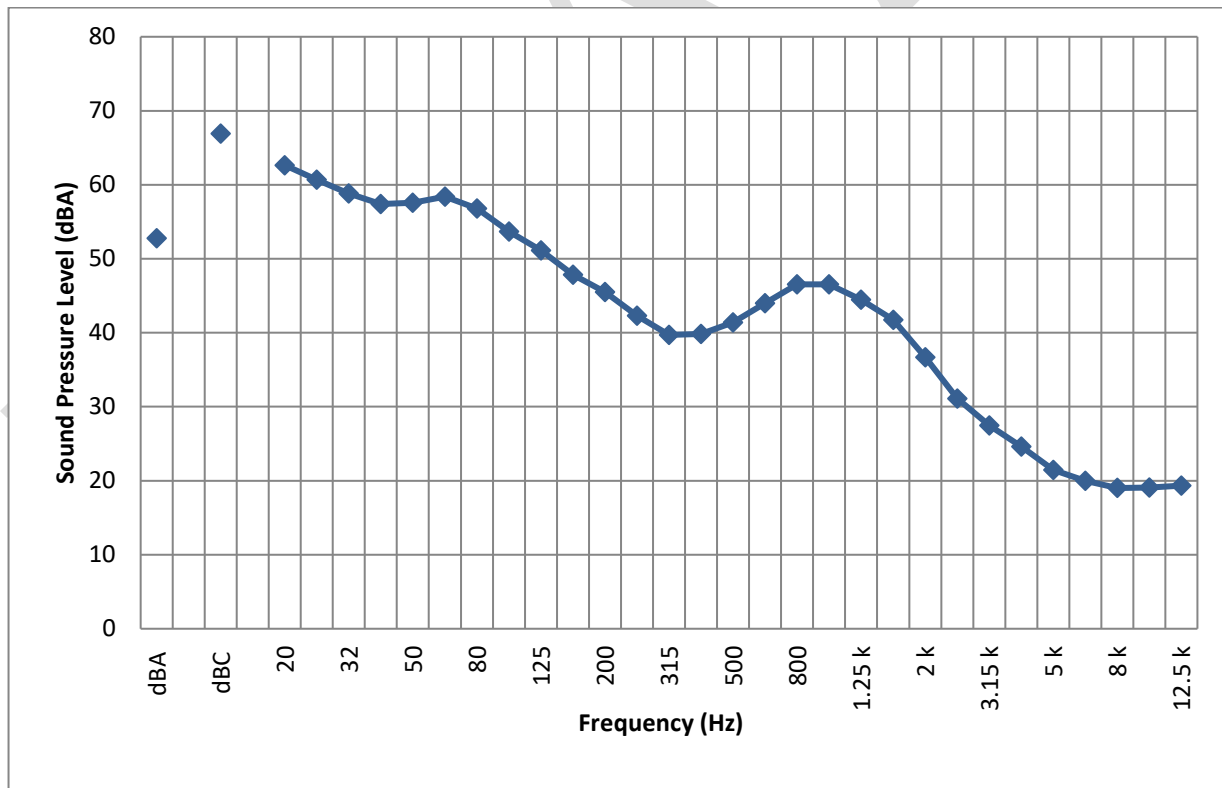

Figure 11. 24-Hour 1/3 Octave Band L_{eq} Sound Levels at Monitor Location 3

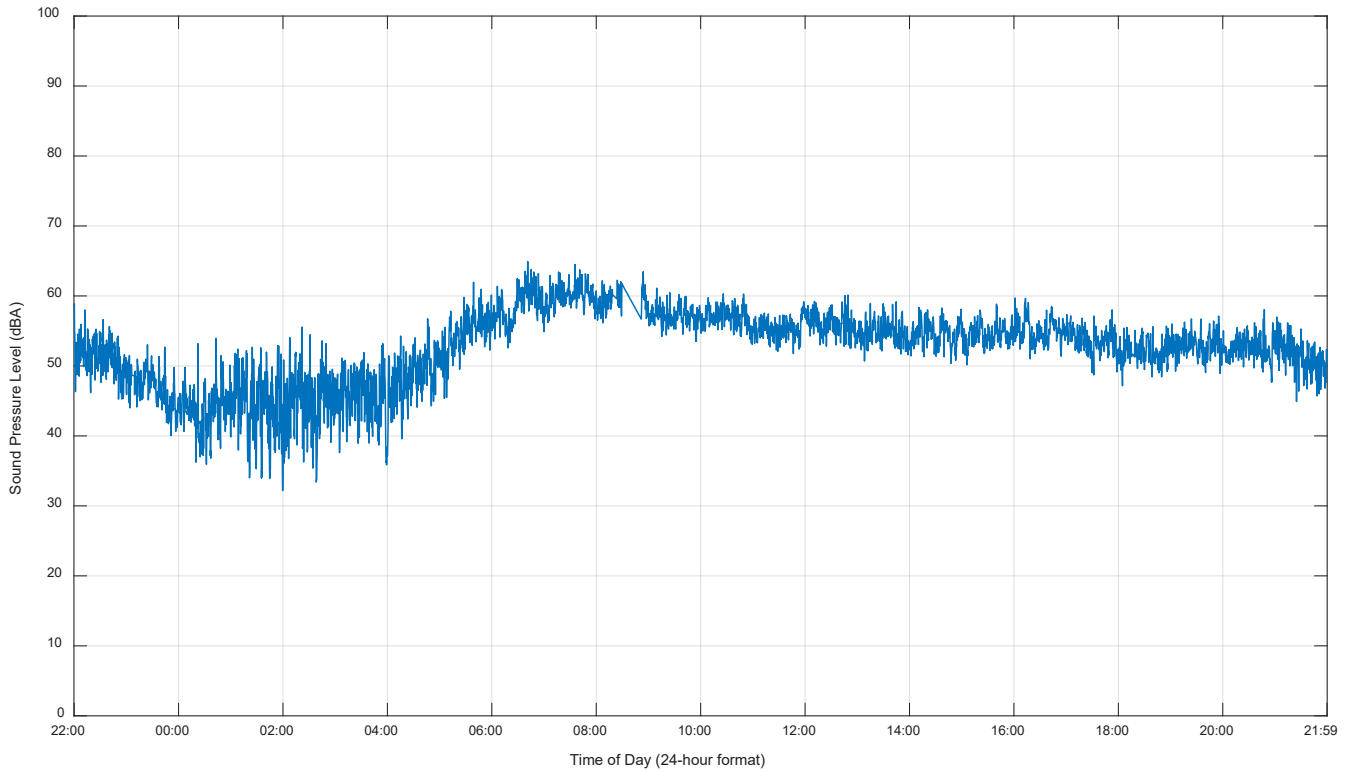

Figure 12. 24-Hour Broadband A-Weighted L_{eq} Sound Levels at Monitor Location 4

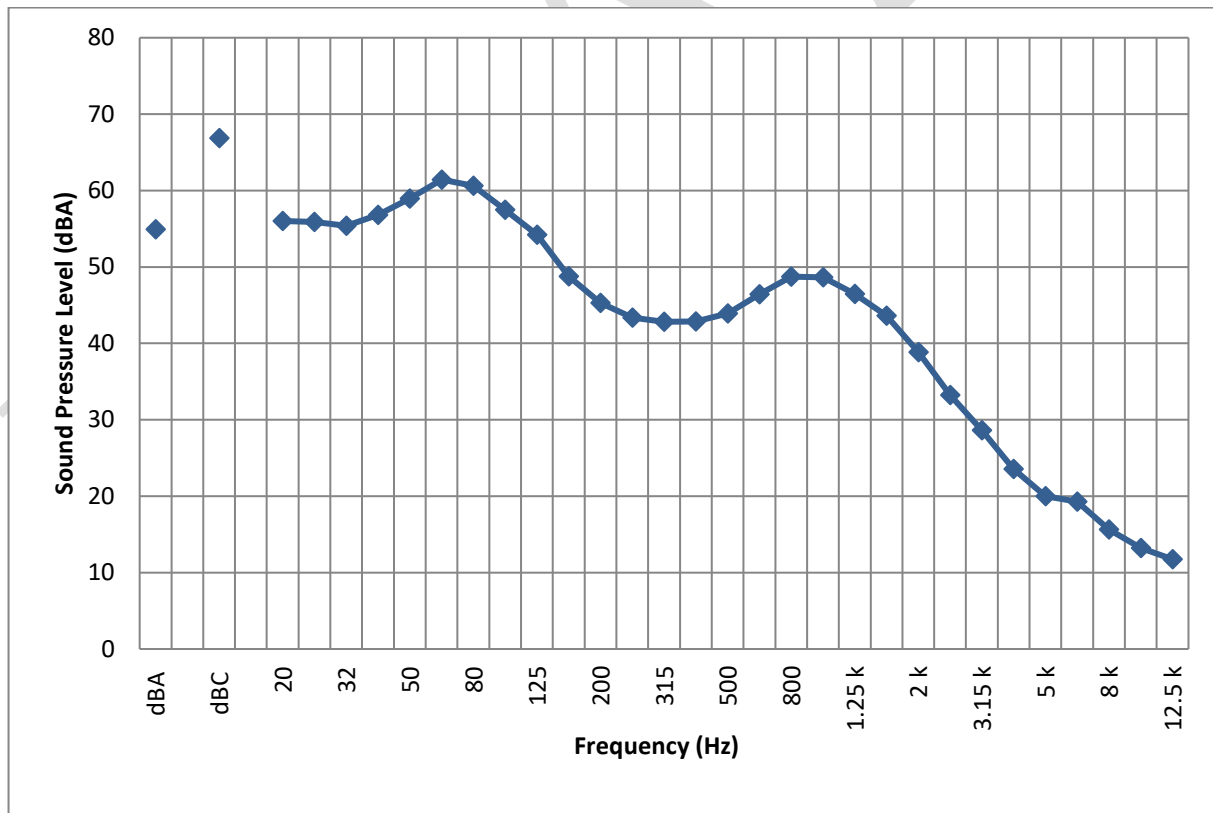

Figure 13. 24-Hour 1/3 Octave Band L_{eq} Sound Levels at Monitor Location 4

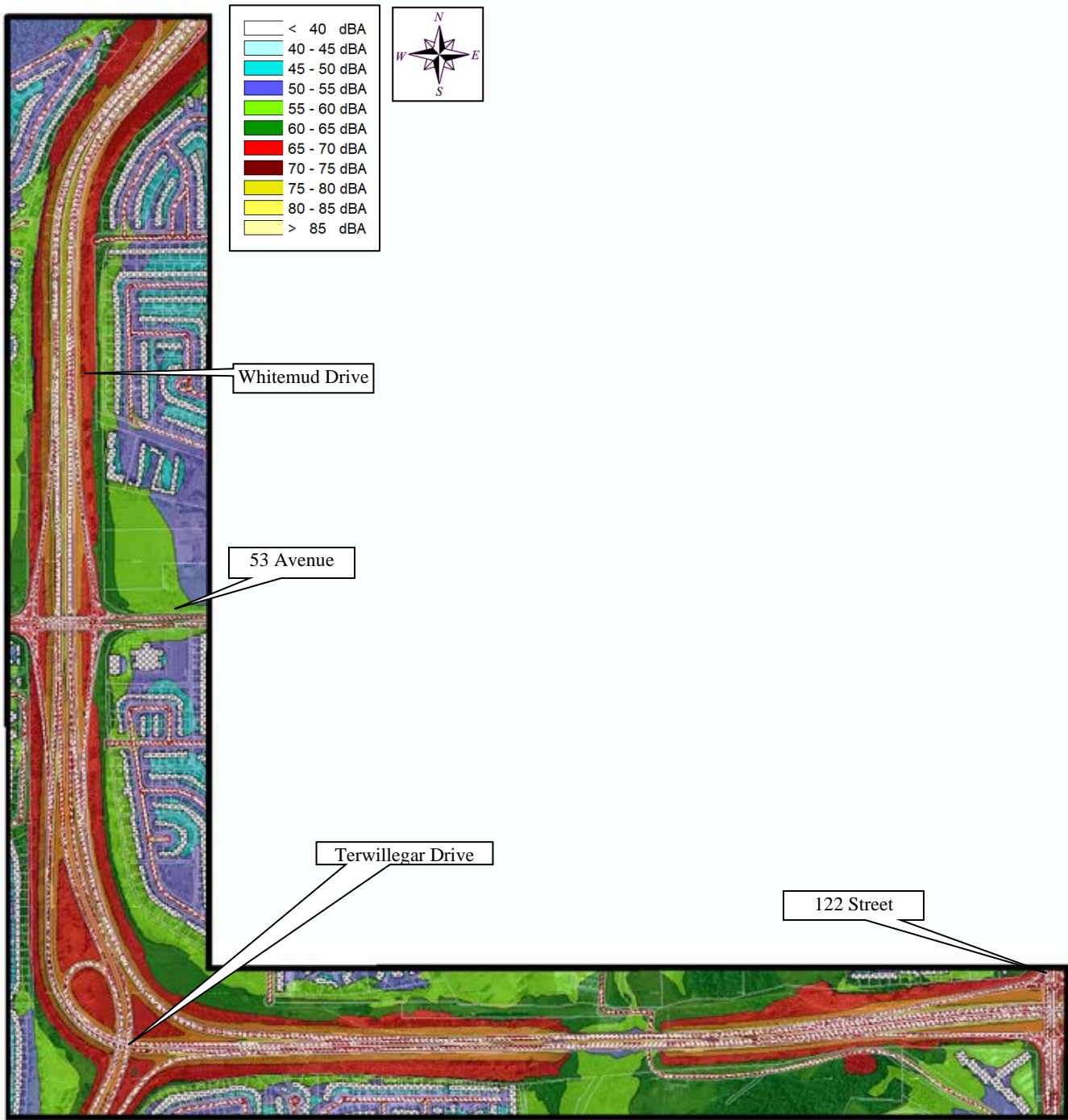
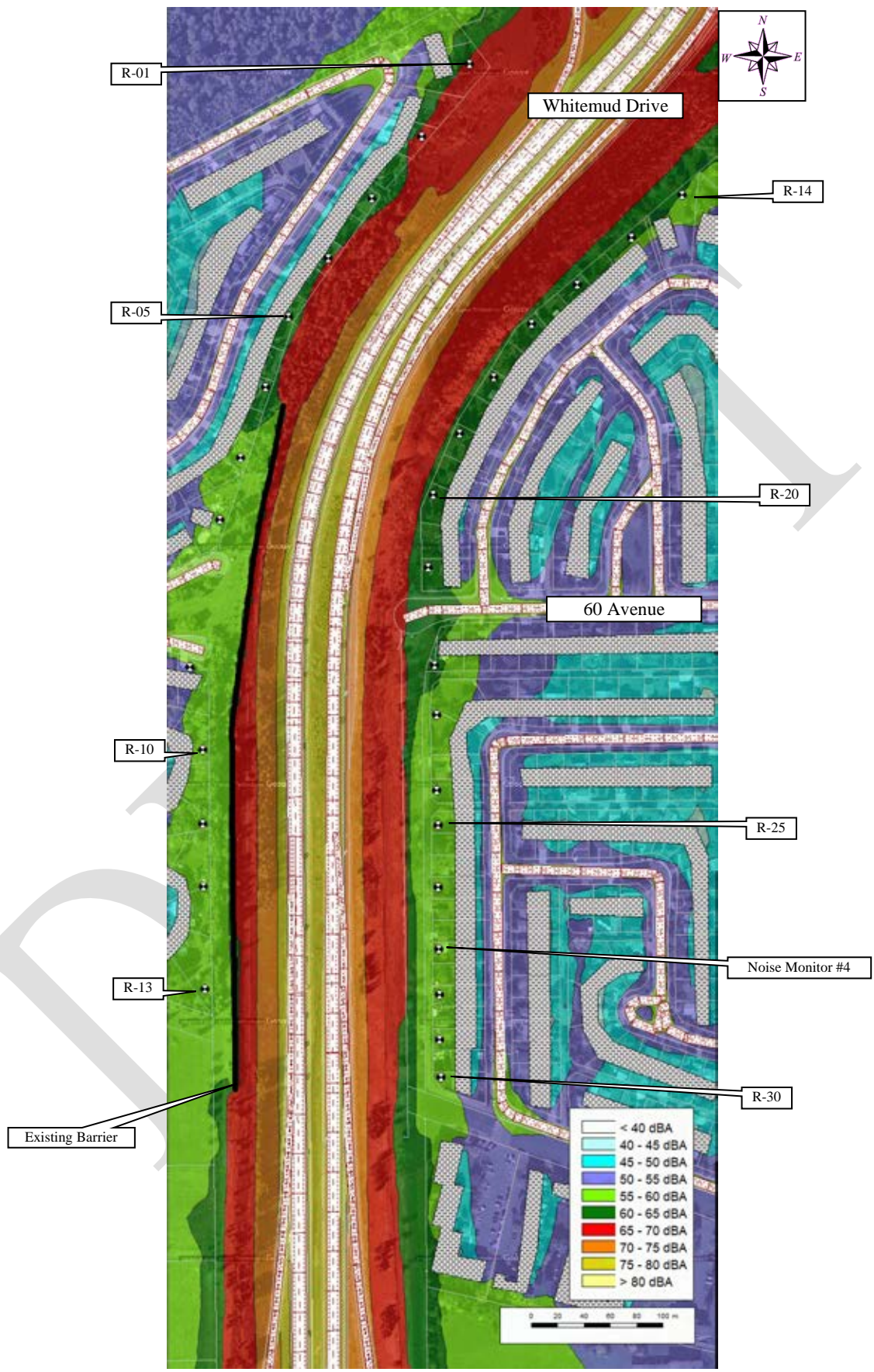

Figure 14a. Current Conditions L_{eq24} Sound Levels for Entire Study Area



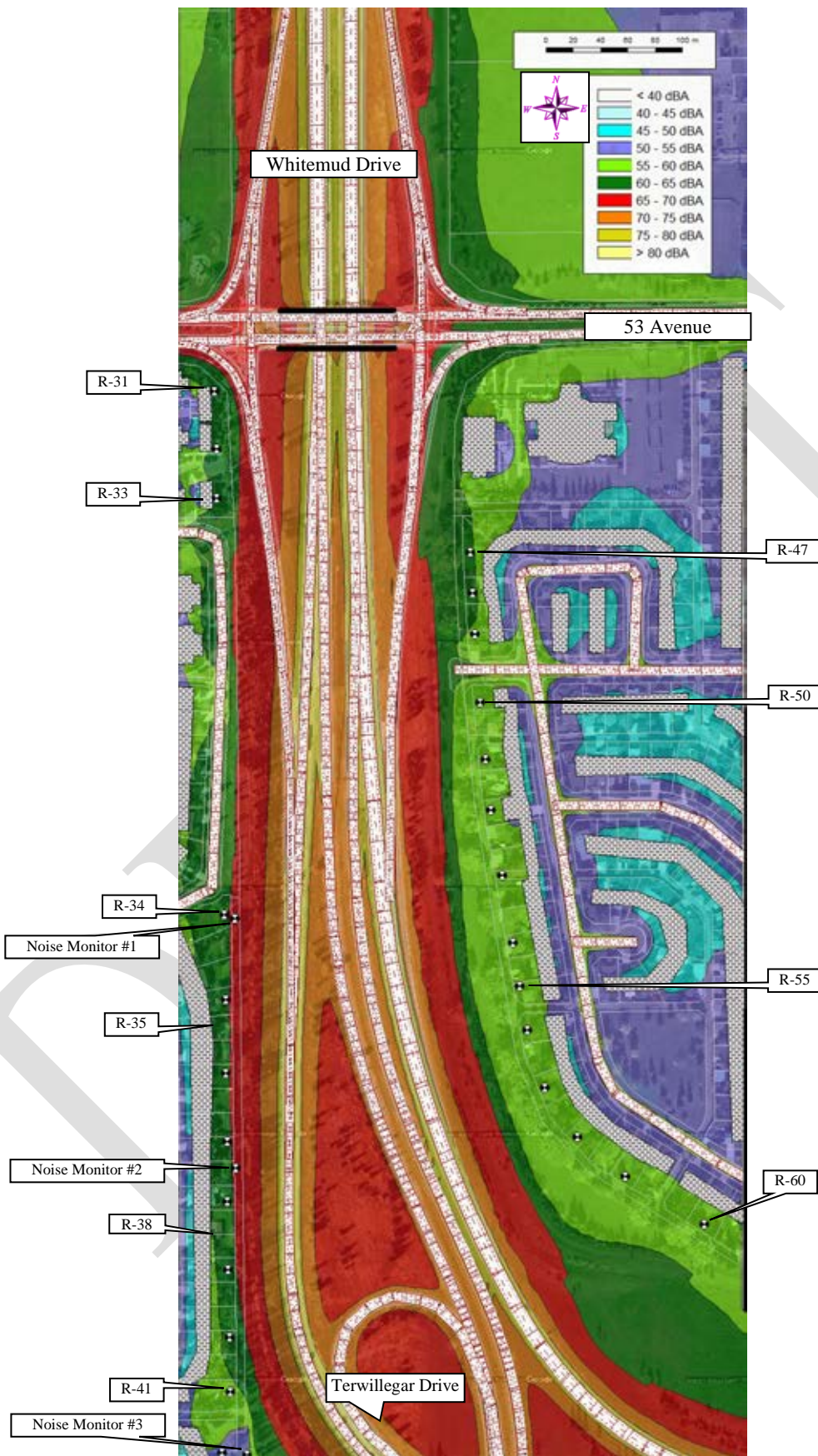

Figure 14c. Current Conditions L_{eq24} Sound Levels (South of 53 Avenue)

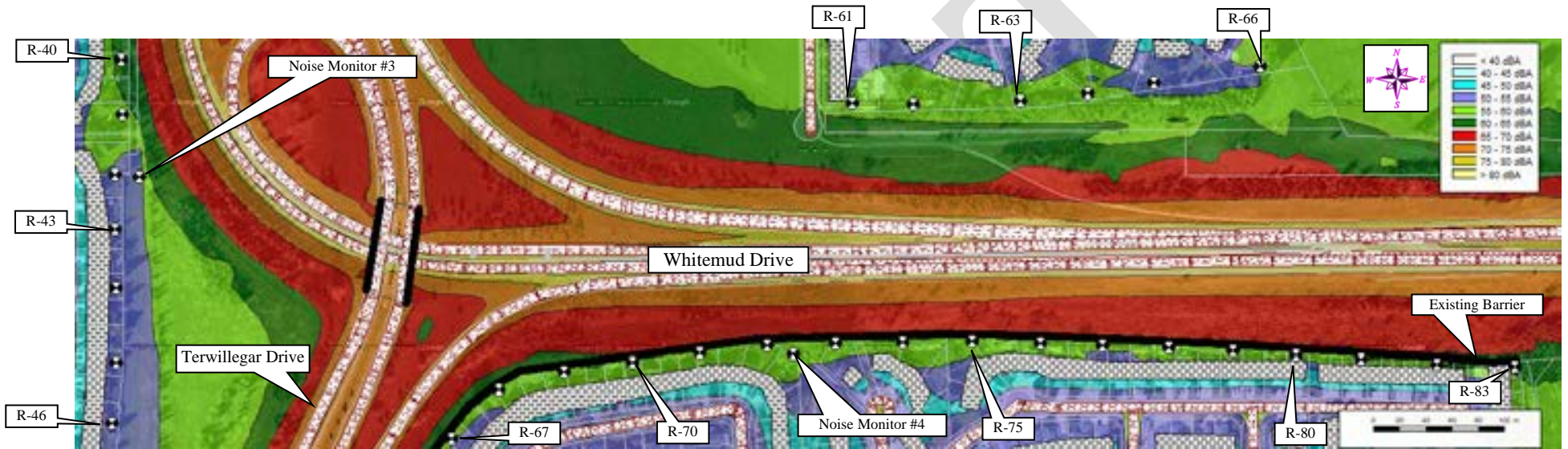

Figure 14d. Current Conditions L_{eq24} Sound Levels (East of Terwillegar Drive)

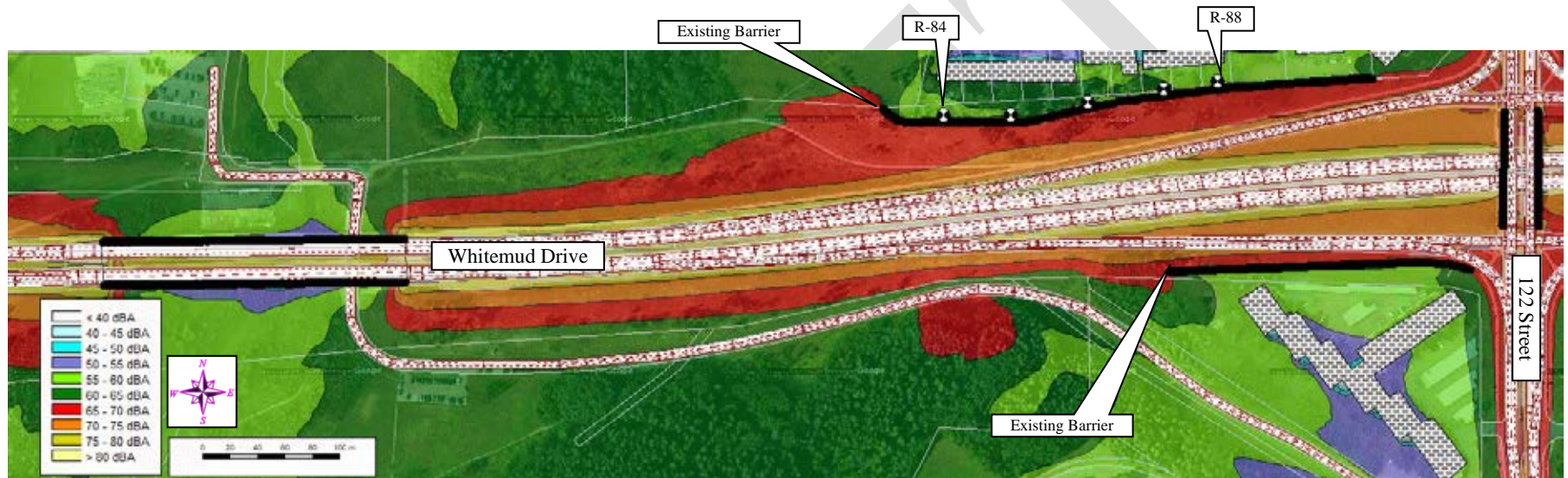

Figure 14e. Current Conditions L_{eq24} Sound Levels (West of 122 Street)

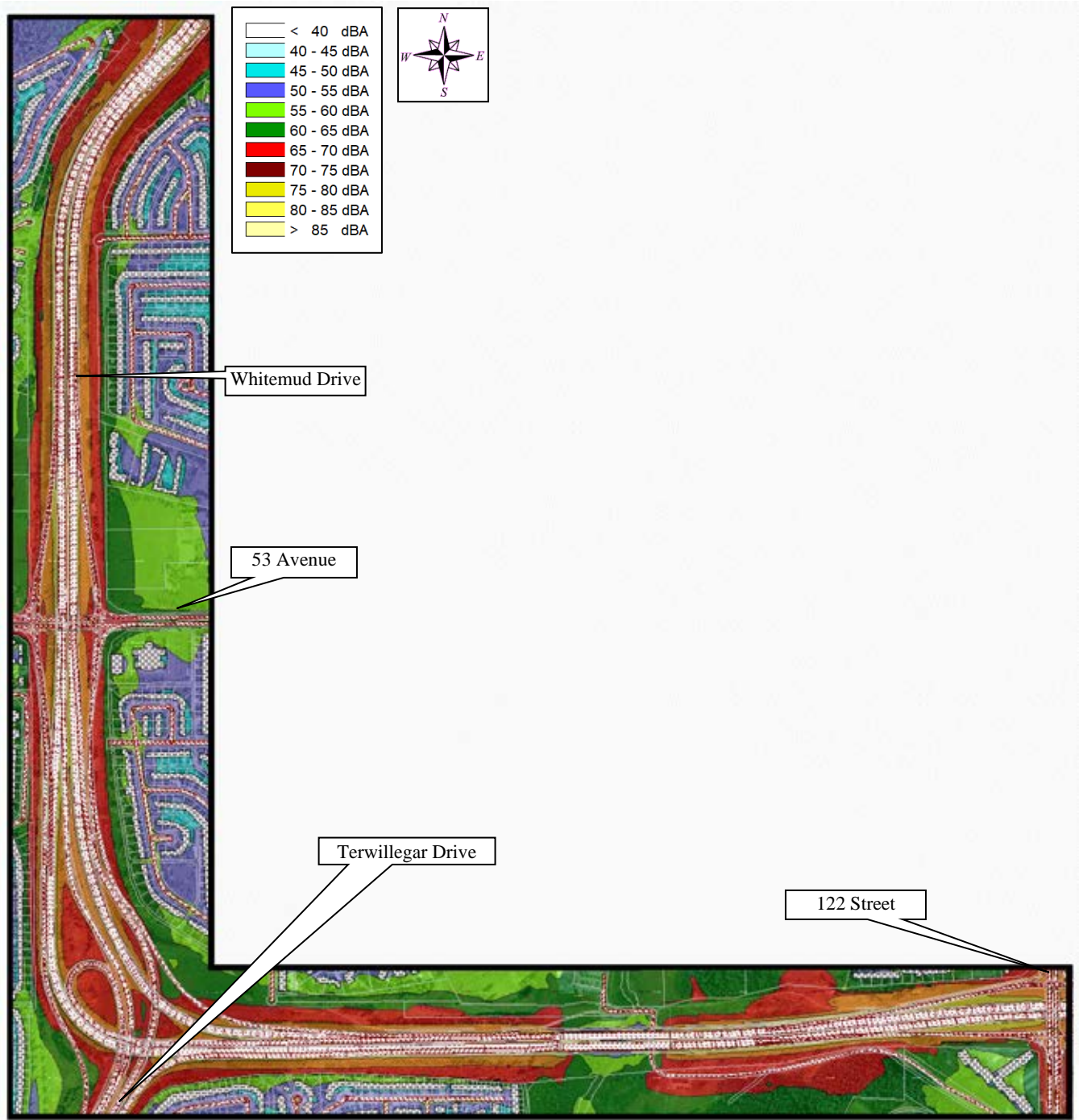

Figure 15a. Future Conditions L_{eq24} Sound Levels for Entire Study Area

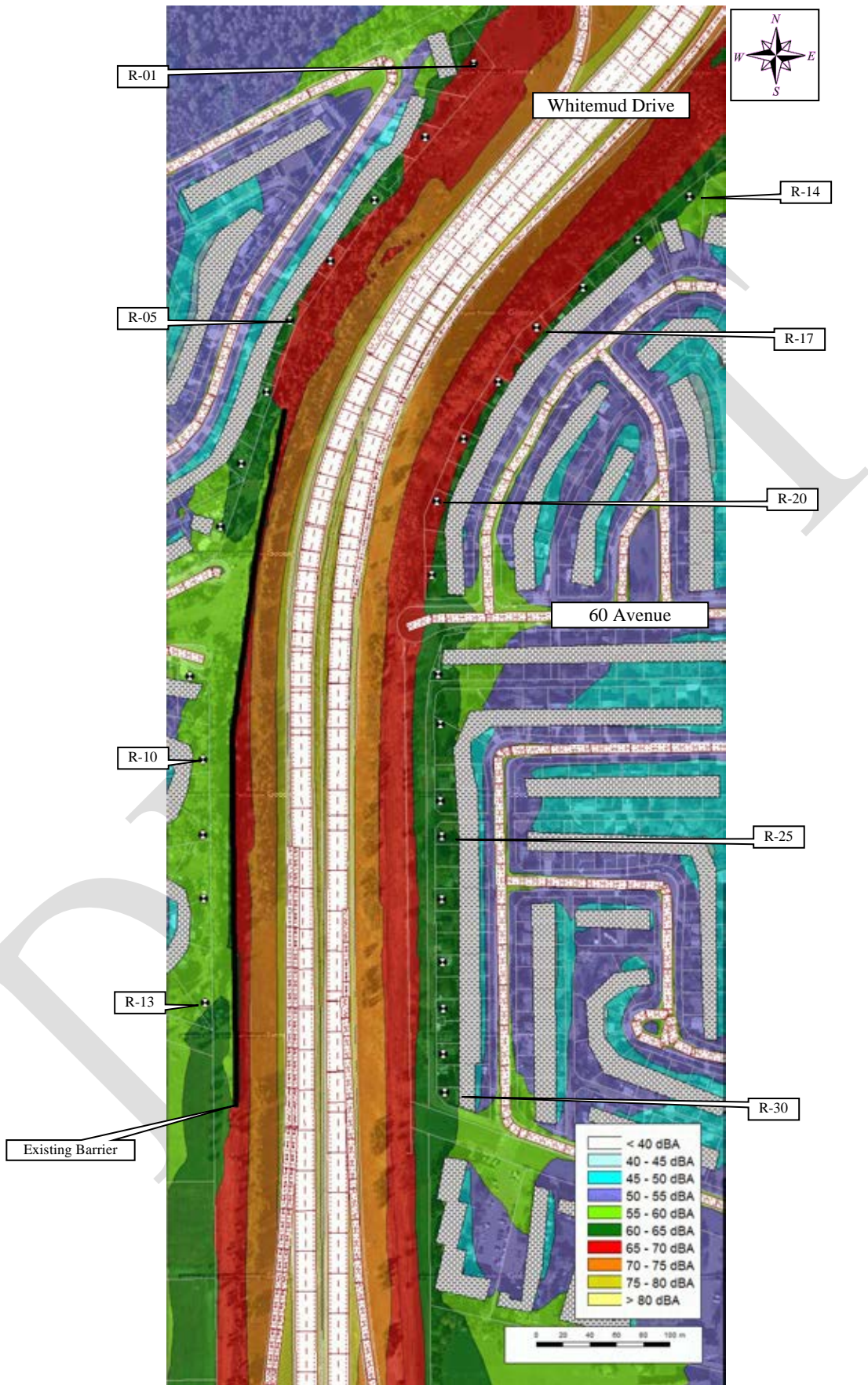

Figure 15b. Future Conditions L_{eq24} Sound Levels (North of 53 Avenue)

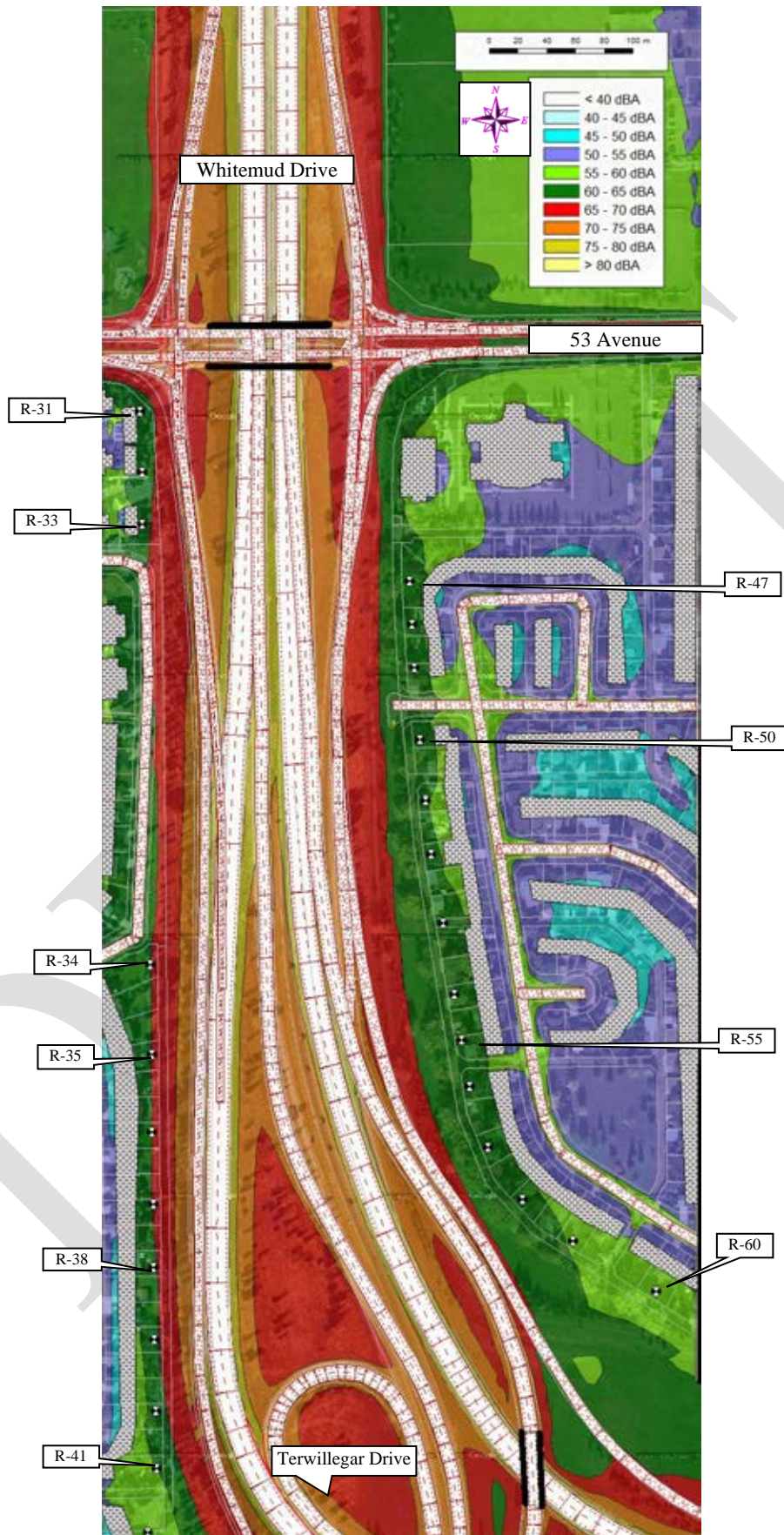

Figure 15c. Future Conditions L_{eq24} Sound Levels (South of 53 Avenue)



Figure 15d. Future Conditions L_{eq24} Sound Levels (East of Terwillegar Drive)

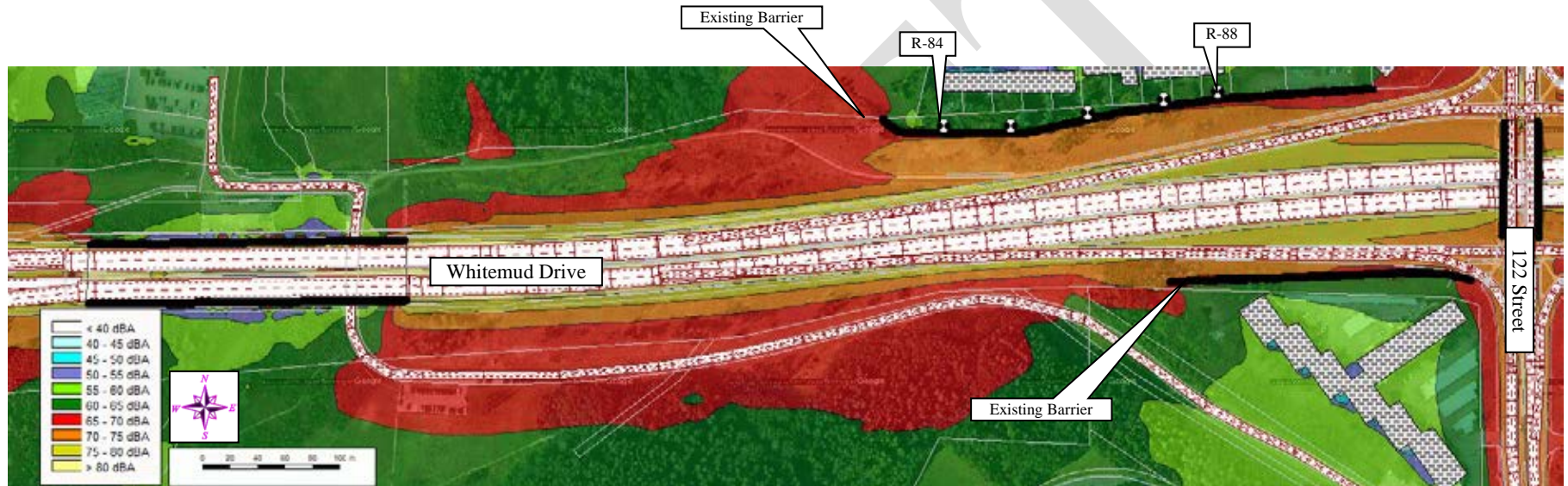

Figure 15e. Future Conditions L_{eq24} Sound Levels (West of 122 Street)

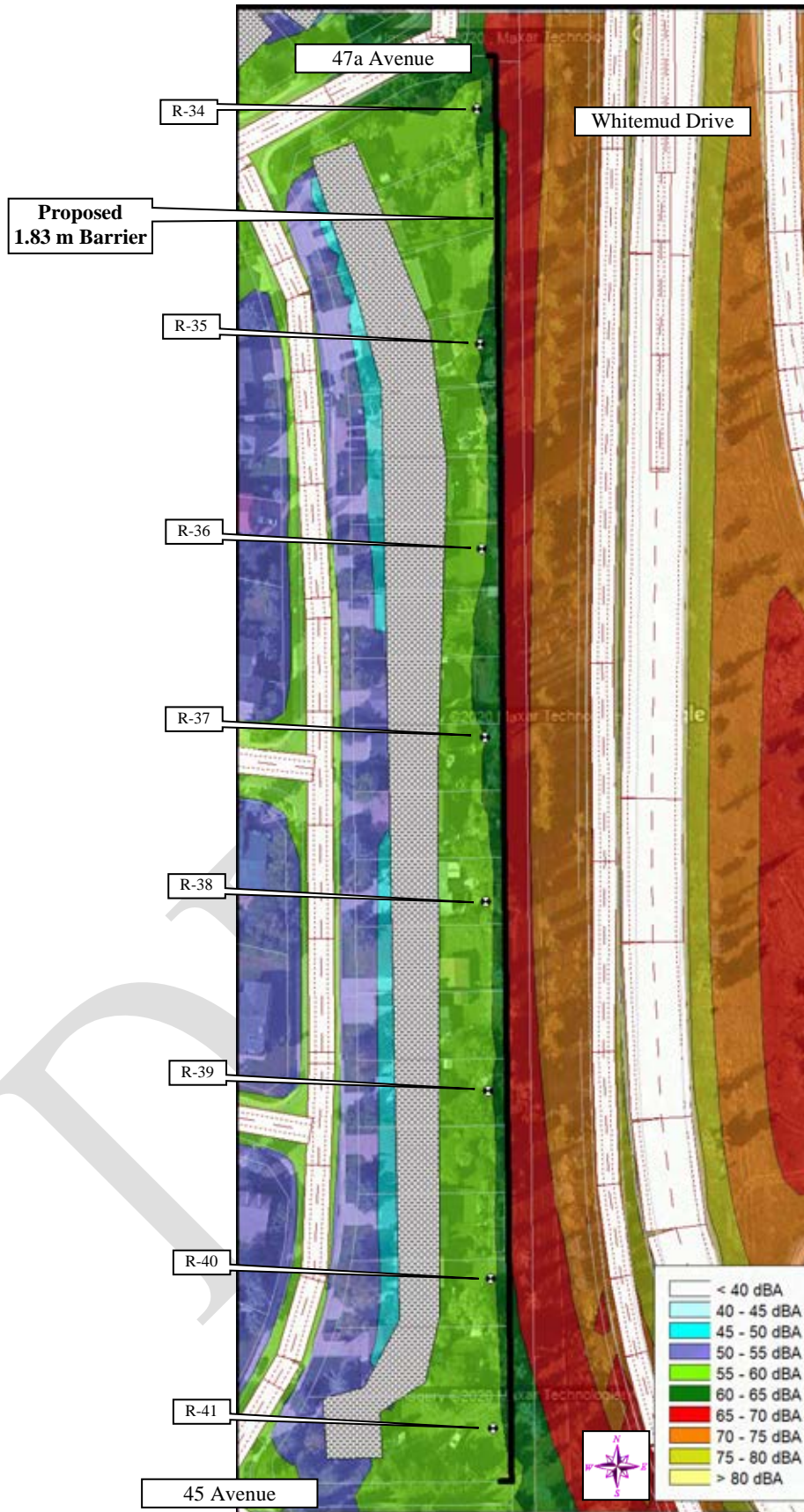

Figure 16. Ramsey Heights Noise Mitigation $L_{eq}24$ Sound Levels



Figure 17. Noise Wall Option Description (Brander Gardens & Brookside)

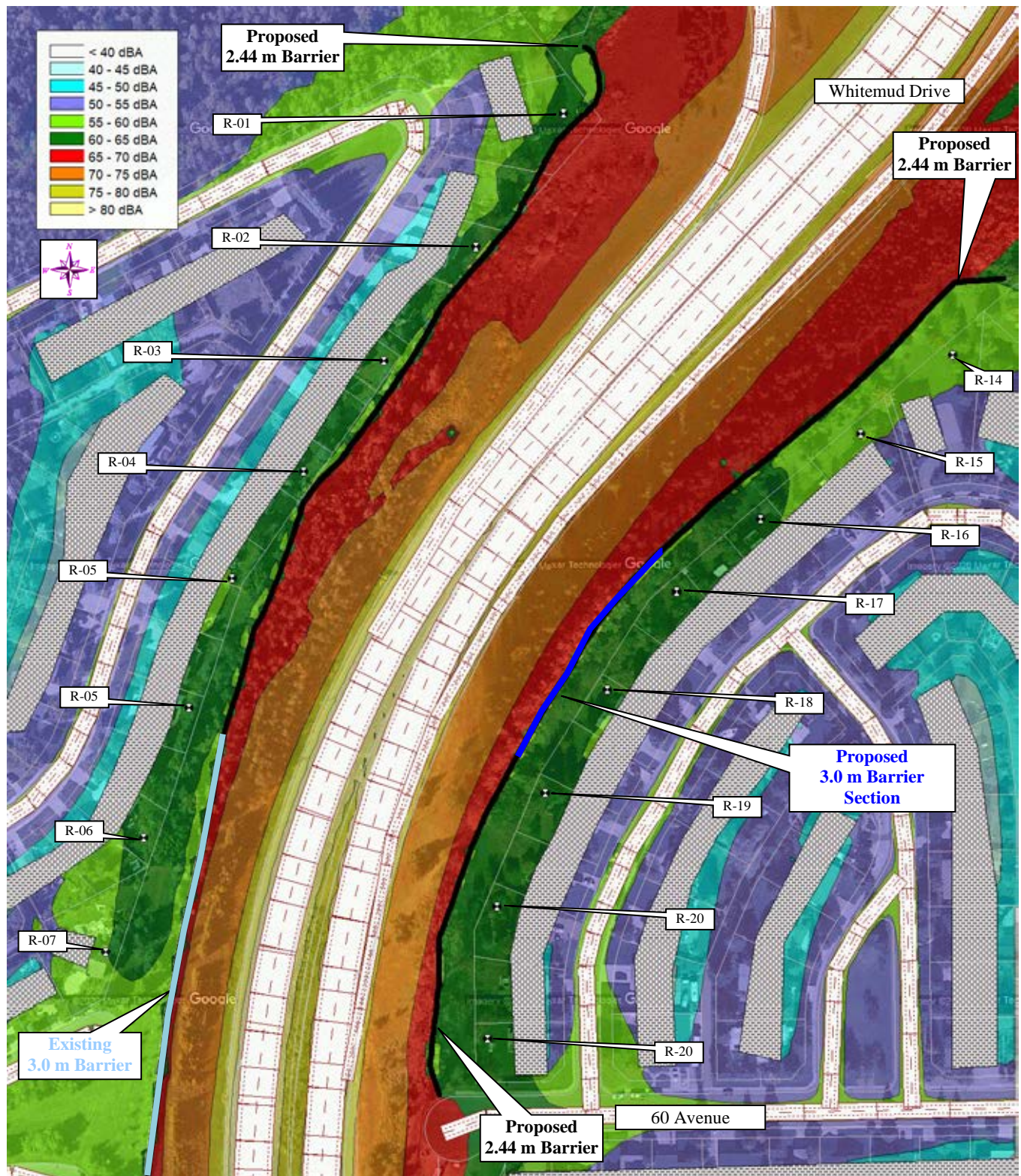

Figure 18. Noise Wall Option #1 $L_{eq}24$ Sound Levels (Brander Gardens & Brookside)

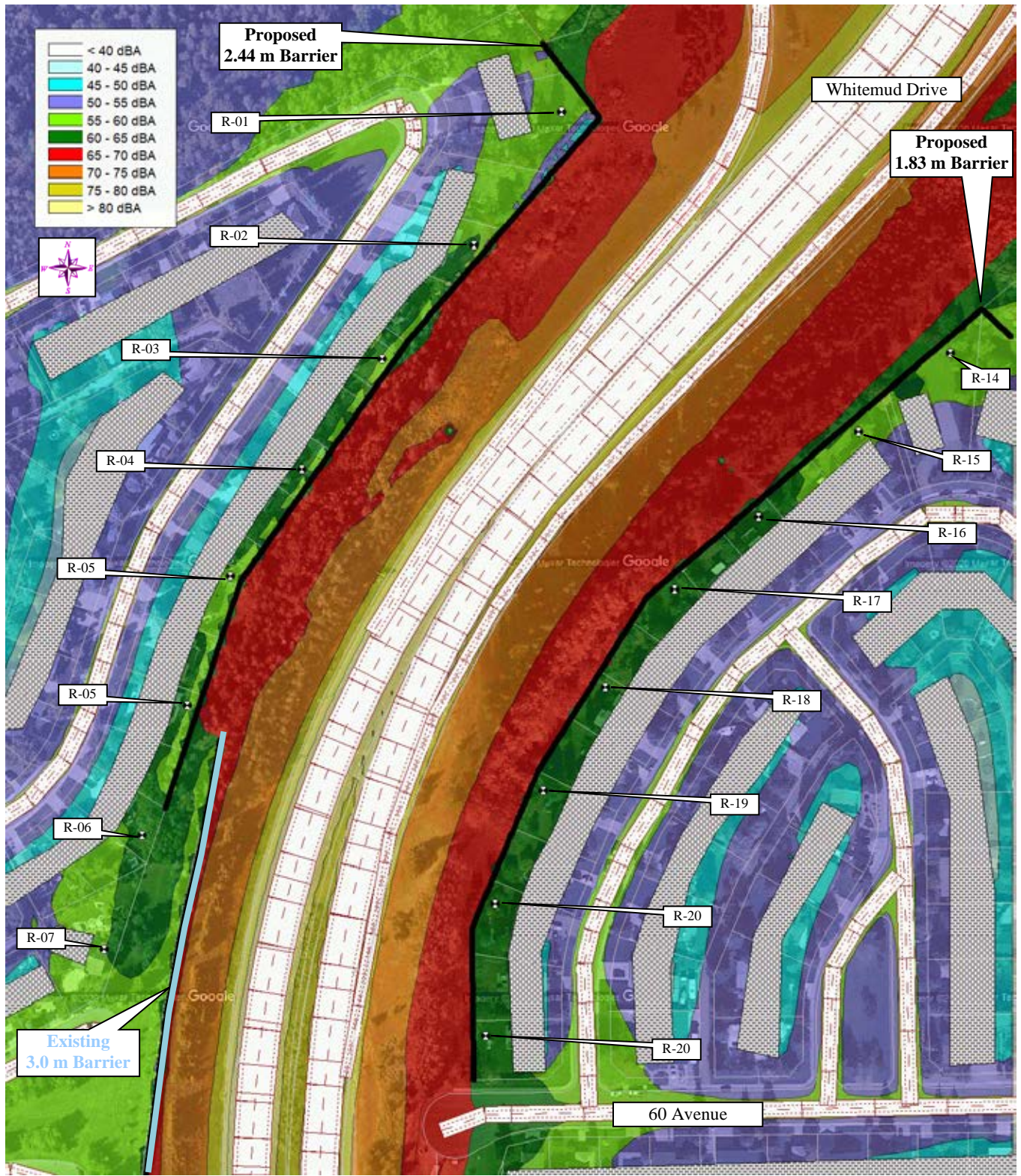

Figure 19. Noise Wall Option #2 L_{eq24} Sound Levels (Brander Gardens & Brookside)

Appendix I MEASUREMENT EQUIPMENT USED

Brüel and Kjær 2250/2270 (Unit 3/ Unit 4 / Unit 6 / Unit 7)

The environmental noise monitoring equipment used consisted of a Brüel and Kjær Type 2250/2270 Precision Integrating Sound Level Meter enclosed in an environmental case, a tripod, a weather protective microphone hood, and an external battery. The system acquired data in 15-second L_{eq} samples using 1/3 octave band frequency analysis and overall A-weighted and C-weighted sound levels. The sound level meter conforms to Type 1, ANSI S1.4, ANSI S1.43, IEC 61672-1, IEC 60651, IEC 60804 and DIN 45657. The 1/3 octave filters conform to S1.11 – Type 0-C, and IEC 61260 – Class 0. The calibrator conforms to IEC 942 and ANSI S1.40. The sound level meter, pre-amplifier and microphone were certified on / April 07, 2021 / March 04, 2021 / March 04, 2021 / April 07, 2021 and the calibrator (type B&K 4231) was certified on March 03, 2021 by a NIST NVLAP Accredited Calibration Laboratory for all requirements of ISO 17025: 1999 and relevant requirements of ISO 9002:1994, ISO 9001:2000 and ANSI/NCSL Z540: 1994 Part 1. Simultaneous digital audio was recorded directly on the sound level meter using a 8 kHz sample rate for more detailed post-processing analysis. Refer to the next section in the Appendix for a detailed description of the various acoustical descriptive terms used.

Weather Monitor

The weather monitoring equipment used for the study consisted of an Orion Weather Station 9510-A-1 with a WXT520 Self-Aspirating Radiation Shield Sensor Unit, a Weather MicroServer 9590 Data-logger, and a Lightning Arrestor. The Data-logger and batteries were located in a grounded, weather protective case. The Sensor Unit was mounted on a sturdy survey tripod (with supporting guy-wires) at approximately 5.0 m above ground. The system was set up to record data in 1-minute samples obtaining the wind-speed, peak wind-speed, and wind-direction in a rolling 2-minute average as well as the 1-minute temperature and relative humidity.

Record of Calibration Results

Description	Date	Time	Pre / Post	Calibration Level	Calibrator Model	Serial Number
Monitor Location #1	19-Apr-21	12:30	Pre	93.9 dBA	B&K 4231	2656414
Monitor Location #1	22-Apr-21	15:00	Post	93.8 dBA	B&K 4231	2656414
Monitor Location #2	19-Apr-21	11:30	Pre	93.9 dBA	B&K 4231	2656414
Monitor Location #2	22-Apr-21	11:30	Post	93.9 dBA	B&K 4231	2656414
Monitor Location #3	19-Apr-21	11:15	Pre	93.9 dBA	B&K 4231	2656414
Monitor Location #3	22-Apr-21	11:40	Post	93.9 dBA	B&K 4231	2656414
Monitor Location #4	19-Apr-21	13:30	Pre	93.9 dBA	B&K 4231	2656414
Monitor Location #4	29-Apr-21	11:30	Post	93.8 dBA	B&K 4231	2656414

DRAFT

B&K 4231 Calibrator Calibration Certificate

Scantek, Inc.

CALIBRATION LABORATORY

ISO 17025: 2005, ANSI/NCSL Z540:1994 Part 1
ACCREDITED by NVLAP (an ILAC MRA signatory)

NVLAP[®]
CALIBRATION
NVLAP Lab Code: 200625-0

Calibration Certificate No.46080

Instrument: Acoustical Calibrator
Model: 4231
Manufacturer: Brüel and Kjær
Serial number: 2575493
Class (IEC 60942): 1
Barometer type:
Barometer s/n:

Date Calibrated: 3/3/2021 **Cal Due:**
Status:

Received	Sent
X	X

In tolerance:

X	X
---	---

Out of tolerance:

--	--

See comments:

--	--

Contains non-accredited tests: Yes X No

Customer: ACI Acoustical Consultants Inc.
Tel/Fax: 780-414-6373 / 780-414-6376

Address: 5031 - 210 Street, Edmonton,
Alberta, CANADA T6M 0A8

Tested in accordance with the following procedures and standards:
Calibration of Acoustical Calibrators, Scantek Inc., Rev. 10/1/2010

Instrumentation used for calibration: Nor-1504 Norsonic Test System:

Instrument - Manufacturer	Description	S/N	Cal. Date	Traceability evidence	
				Cal. Lab / Accreditation	Cal. Due
483B-Norsonic	SME Cal Unit	31052	Oct 31, 2020	Scantek, Inc./ NVLAP	Oct 31, 2021
DS-360-SRS	Function Generator	33584	Oct 23, 2019	ACR Env./ A2LA	Oct 23, 2021
34401A-Agilent Technologies	Digital Voltmeter	MY47011118	Feb 4, 2021	ACR Env./ A2LA	Feb 4, 2022
HM30-Thommen	Meteo Station	1040170/39633	Dec 7, 2020	ACR Env./ A2LA	Dec 7, 2021
140-Norsonic	Real Time Analyzer	1406423	Nov 3, 2020	Scantek / NVLAP	Nov 3, 2021
PC Program 1018 Norsonic	Calibration software	v.6.1T	Validated Nov 2014	Scantek, Inc.	-
4134-Brüel&Kjær	Microphone	173368	Oct 26, 2020	Scantek, Inc. / NVLAP	Oct 26, 2021
1203-Norsonic	Preamplifier	14059	March 3, 2020	Scantek, Inc./ NVLAP	March 3, 2021

Instrumentation and test results are traceable to SI (International System of Units) through standards maintained by NIST (USA) and NPL (UK)

Calibrated by:	Lydon Dawkins	Authorized signatory:	William D. Gallagher
Signature	<i>Lydon Dawkins</i>	Signature	<i>William D. Gallagher</i>
Date	3/3/2021	Date	3/5/2021

Calibration Certificates or Test Reports shall not be reproduced, except in full, without written approval of the laboratory.
This Calibration Certificate or Test Reports shall not be used to claim product certification, approval or endorsement by NVLAP, NIST, or any agency of the federal government.
Document stored as: Y:\Calibration Lab\Cal 2021\0NK4231_2575493_M1.doc

B&K 2270 Unit #3 SLM Calibration Certificates

CALIBRATED BY TRANSCAT CERTIFICATE OF CALIBRATION



Customer: ACI ACOUSTICAL CONSULTANTS IN
5031-210 STREET NW
EDMONTON, AB T6M 0A8

PO Number: BILAWCHUK

Certificate/ISO Number: 17-Q1X3X-80-1 Revision 0

Manufacturer: Bruel & Kjaer
Model Number: 2270
Description: Sound Level Meter
Serial Number: 30027302850741
ID: UNIT 3

As-Found: In Tolerance
As-Left: In Tolerance
Issue Date: Apr 07, 2021
Calibration Date: Apr 07, 2021

Calibrated To: Manufacturer Specification
Calibration Procedure: 1-AC28543-3

Transcat Calibration Laboratories have been notified and found in compliance with ISO/IEC 17025:2017. Accredited calibrations performed within the Lab's Scope of Accreditation are indicated by the presence of the Accrediting Body's Logo and Certificate Number. Any measurements on an accredited calibration not covered by that Lab's Scope of Accreditation are listed in the notes section of this certificate. SCC, NRC, CLAS or ANAB do not guarantee the accuracy of an individual calibration by accredited laboratories.

Transcat calibrations, as applicable, are performed in compliance with the requirements of the Transcat Quality Manual QAC/PI-000, the customer's Purchase Order and/or Quality Agreement requirements, ISO 9001:2015, ANSI/ISO-ILAC 1:1994 (1:2002) or NGA-1, as applicable. Complete records of work performed are maintained by Transcat and are available for inspection. Laboratory standards used in the performance of this calibration are listed on this certificate.

Transcat documents the traceability of measurements to the SI units through the National Institute of Standards and Technology (NIST), or the National Research Council of Canada (NRC), or other national measurement institutes (NMI) that are separate to the CIPM Mutual Recognition Arrangement. Accredited fundamental and/or natural physical constants, or by the use of specified methods, consensus standards or ratio type measurements. Documentation supporting traceability information is available for review upon written request at a Transcat facility. The measured quantity and the measurement uncertainty are required for further dissemination of traceability.

A binary decision rule, utilizing simple acceptance, and simple rejection criteria is used for the determination of compliance, unless otherwise specified by the client's Decision Rule. When Calibration Tolerance compliance statements are present, they are reported without factoring in the effects of uncertainty and comply with the guidelines established by ASME B89.7.3.1-2004 (B20.19) as follows:

- The acceptance zone is defined as less than or equal to the high calibration tolerance limit, and/or greater than or equal to the low calibration tolerance limit.
- Single measurement results in the acceptance zone are identified as in-tolerance. Single measurement results in the rejection zone are identified as out-of-tolerance (OOT).
- When all measurement results are in the acceptance zone for repeated measurements for the same characteristic, the test is identified as in-tolerance. For repeated characteristic measurements, a single measurement result in the rejection zone, will cause the test to be identified as out-of-tolerance (OOT).

Uncertainties are reported with a coverage factor k=2, providing a level of confidence of approximately 95%. All calibrations have been performed using processes having a TUR of 4:1 or better (3:1 for mass calibrations) unless otherwise noted. The Test Uncertainty Ratio (TUR) is calculated in accordance with NCSL International RSA.16. For mass calibrations, Conventional mass referenced to 8.0 g/cm³.

The results in this report relate only to the item calibrated or tested. Reported calibration data is valid at the time of calibration within the stated uncertainties at the environmental conditions noted. The determination of compliance to the specification is specific to the method and/or test procedure above based on the tolerances shown; these tolerances are either the original equipment manufacturer's (OEM's) warranted specifications or the client's requested specifications. This certificate may not be reproduced except in full, without the written approval of Transcat. Additional information, if applicable may be included on separate reports.

Date Received: March 18, 2021
Service Level: R9

Certificate - Page 1 of 7

Customer Number: 9-330269-000
OPS-F20-01488 04/07/21, FPO1480 4/2/2021

B&K 2270 Unit #4 SLM Calibration Certificate

Scantek, Inc.

CALIBRATION LABORATORY

ISO 17025: 2005, ANSI/NCSL Z540:1994 Part 1
ACCREDITED by NVLAP (an ILAC MRA signatory)

NVLAP[®]
CALIBRATION
NVLAP Lab Code: 200625-0

Calibration Certificate No.46085

Instrument: Sound Level Meter
Model: 2270
Manufacturer: Brüel and Kjær
Serial number: 2644639
Tested with: Microphone 4189 s/n 2595637
Preamplifier ZC0032 s/n 5842
Type (class): 1
Customer: ACI Acoustical Consultants Inc.
Tel/Fax: 780-414-6373 / 780-414-6376

Date Calibrated: 3/5/2021 **Cal Due:**
Status:

Received	Sent
X	X

In tolerance:

--	--

Out of tolerance:

--	--

See comments:

--	--

Contains non-accredited tests: ___ Yes X No
Calibration service: ___ Basic X Standard
Address: 5031 - 210 Street, Edmonton,
Alberta, CANADA T6M 0A8

Tested in accordance with the following procedures and standards:
Calibration of Sound Level Meters, Scantek Inc., Rev. 6/26/2015
SLM & Dosimeters – Acoustical Tests, Scantek Inc., Rev. 7/6/2011

Instrumentation used for calibration: Nor-1504 Norsonic Test System:

Instrument - Manufacturer	Description	S/N	Cal. Date	Traceability evidence	
				Cal. Lab / Accreditation	Cal. Due
483B-Norsonic	SME Cal Unit	31052	Oct 31, 2020	Scantek, Inc./ NVLAP	Oct 31, 2021
DS-360-SRS	Function Generator	33584	Oct 23, 2019	ACR Env./ A2LA	Oct 23, 2021
34401A-Agilent Technologies	Digital Voltmeter	MY47011118	Feb 4, 2021	ACR Env./ A2LA	Feb 4, 2022
HM30-Thommen	Meteo Station	1040170/39633	Dec 7, 2020	ACR Env./ A2LA	Dec 7, 2021
PC Program 1019 Norsonic	Calibration software	v.6.1T	Validated Nov 2014	Scantek, Inc.	-
1251-Norsonic	Calibrator	30878	Oct 26, 2020	Scantek, Inc./ NVLAP	Oct 26, 2021

Instrumentation and test results are traceable to SI (International System of Units) through standards maintained by NIST (USA) and NPL (UK).

Environmental conditions:

Temperature (°C)	Barometric pressure (kPa)	Relative Humidity (%)
23.0	100.24	39.5

Calibrated by:	Lydon Dawkins	Authorized signatory:	William D. Gallagher
Signature	<i>Lydon Dawkins</i>	Signature	<i>William D. Gallagher</i>
Date	3/5/2021	Date	3/5/2021

Calibration Certificates or Test Reports shall not be reproduced, except in full, without written approval of the laboratory.
This Calibration Certificate or Test Reports shall not be used to claim product certification, approval or endorsement by NVLAP, NIST, or any agency of the federal government.
Document stored Y:\Calibration Lab\SLM 2021\BNK2270_2644639_M1.doc Page 1 of 2

B&K 2270 Unit #4 Microphone Calibration Certificate

Scantek, Inc.
CALIBRATION LABORATORY

ISO 17025: 2005, ANSI/NCSL Z540:1994 Part 1
ACCREDITED by NVLAP (an ILAC MRA signatory)

NVLAP[®]
CALIBRATION
NVLAP Lab Code: 200625-0

Calibration Certificate No.46086

Instrument: Microphone
Model: 4189
Manufacturer: Brüel & Kjær
Serial number: 2595637
Composed of:

Date Calibrated: 3/4/2021 **Cal Due:**
Status: **Received** **Sent**
In tolerance: **X** **X**
Out of tolerance: _____
See comments: _____
Contains non-accredited tests: Yes **X** No

Customer: ACI Acoustical Consultants Inc.
Tel/Fax: 780-414-6373/780-414-6376

Address: 5031 - 210 Street, Edmonton,
Alberta, CANADA T6M 0A8

Tested in accordance with the following procedures and standards:
Calibration of Measurement Microphones, Scantek, Inc., Rev. 2/25/2015

Instrumentation used for calibration: N-1504 Norsonic Test System:

Instrument - Manufacturer	Description	S/N	Cal. Date	Traceability-evidence	
				Cal. Lab / Accreditation	Cal. Due
4838-Norsonic	SME Cal Unit	31052	Oct 31, 2020	Scantek, Inc./ NVLAP	Oct 31, 2021
DS-360-SRS	Function Generator	33584	Oct 23, 2019	ACR Env. / A2LA	Oct 23, 2021
34401A-Agilent Technologies	Digital Voltmeter	MY47011118	Feb 4, 2021	ACR Env. / A2LA	Feb 4, 2022
HM30-Thommen	Meteo Station	1040170/39633	Dec 7, 2020	ACR Env. / A2LA	Dec 7, 2021
PC Program 1017 Norsonic	Calibration software	v.6.1T	Validated Nov 2014	Scantek, Inc.	-
1253-Norsonic	Calibrator	28326	Oct 26, 2020	Scantek, Inc./ NVLAP	Oct 26, 2021
1203-Norsonic	Preamplifier	14059	March 3, 2021	Scantek, Inc./ NVLAP	March 3, 2022
4180-Brüel&Kjær	Microphone	2246115	Oct 1, 2019	DPLA / DANAK	Oct 1, 2021

Instrumentation and test results are traceable to SI - BIPM through standards maintained by NPL (UK) and NIST (USA)

Calibrated by:	Lydon Dawkins	Authorized signatory:	William D. Gallagher
Signature	<i>Lydon Dawkins</i>	Signature	<i>William D. Gallagher</i>
Date	3/4/2021	Date	3/5/2021

Calibration Certificates or Test Reports shall not be reproduced, except in full, without written approval of the laboratory.
This Calibration Certificate or Test Reports shall not be used to claim product certification, approval or endorsement by NVLAP, NIST, or any agency of the federal government.
Document stored as: Y:\Calibration Lab\Mic 2021\B&K4189_2595637_M1.doc Page 1 of 2

B&K 2250 Unit #6 SLM Calibration Certificate

Scantek, Inc.
CALIBRATION LABORATORY

ISO 17025: 2005, ANSI/NCCL Z540:1994 Part 1
ACCREDITED by NVLAP (an ILAC MRA signatory)

NVLAP[®]
CALIBRATION
NVLAP Lab Code: 200625-0

Calibration Certificate No.46083

<p>Instrument: Sound Level Meter Model: 2250 Manufacturer: Brüel and Kjær Serial number: 2661161 Tested with: Microphone 4189 s/n 2650730 Preamplifier ZC0032 s/n 9935 Type (class): 1 Customer: ACI Acoustical Consultants Inc. Tel/Fax: 780-414-6373 / 780-414-6376</p>	<p>Date Calibrated: 3/4/2021 Cal Due: Status: <table border="1" style="display: inline-table; border-collapse: collapse;"><tr><td style="padding: 2px;">Received</td><td style="padding: 2px;">Sent</td></tr><tr><td style="text-align: center; padding: 2px;">X</td><td style="text-align: center; padding: 2px;">X</td></tr></table> In tolerance: <table border="1" style="display: inline-table; border-collapse: collapse;"><tr><td style="padding: 2px;"> </td><td style="padding: 2px;"> </td></tr></table> Out of tolerance: <table border="1" style="display: inline-table; border-collapse: collapse;"><tr><td style="padding: 2px;"> </td><td style="padding: 2px;"> </td></tr></table> See comments: Contains non-accredited tests: Yes <input type="checkbox"/> No <input checked="" type="checkbox"/> Calibration service: Basic <input type="checkbox"/> Standard <input checked="" type="checkbox"/> Address: 5031 - 210 Street, Edmonton, Alberta, CANADA T6M 0A8</p>	Received	Sent	X	X				
Received	Sent								
X	X								

Tested in accordance with the following procedures and standards:
Calibration of Sound Level Meters, Scantek Inc., Rev. 6/26/2015
SLM & Dosimeters – Acoustical Tests, Scantek Inc., Rev. 7/6/2011

Instrumentation used for calibration: Nor-1504 Norsonic Test System:

Instrument - Manufacturer	Description	S/N	Cal. Date	Traceability evidence	Cal. Due
				Cal. Lab / Accreditation	
483B-Norsonic	SME Cal Unit	31052	Oct 31, 2020	Scantek, Inc./ NVLAP	Oct 31, 2021
DS-360-SRS	Function Generator	33584	Oct 23, 2019	ACR Env./ A2LA	Oct 23, 2021
34401A-Agilent Technologies	Digital Voltmeter	MY47011118	Feb 4, 2021	ACR Env./ A2LA	Feb 4, 2022
HM30-Thammen	Meteo Station	1040170/39633	Dec 7, 2020	ACR Env./ A2LA	Dec 7, 2021
PC Program 1019 Norsonic	Calibration software	v.6.1T	Validated Nov 2014	Scantek, Inc.	-
1251-Norsonic	Calibrator	30878	Oct 26, 2020	Scantek, Inc./ NVLAP	Oct 26, 2021

Instrumentation and test results are traceable to SI (International System of Units) through standards maintained by NIST (USA) and NPL (UK).

Environmental conditions:

Temperature (°C)	Barometric pressure (kPa)	Relative Humidity (%)
22.9	99.66	42.5

Calibrated by:	Lydon Dawking	Authorized signatory:	William D. Gallagher
Signature	<i>Lydon Dawking</i>	Signature	<i>William D. Gallagher</i>
Date	3/4/2021	Date	3/5/2021

Calibration Certificates or Test Reports shall not be reproduced, except in full, without written approval of the laboratory.
This Calibration Certificate or Test Reports shall not be used to claim product certification, approval or endorsement by NVLAP, NIST, or any agency of the federal government.

Document stored Y:\Calibration Lab\SLM 2021\BNK2250_2661161_M1.doc

Page 1 of 2

B&K 2250 Unit #6 Microphone Calibration Certificate

Scantek, Inc.

CALIBRATION LABORATORY

ISO 17025: 2005, ANSI/NCCL Z540:1994 Part 1
ACCREDITED by NVLAP (an ILAC MRA signatory)

NVLAP[®]
CALIBRATION
NVLAP Lab Code: 200625-0

Calibration Certificate No.46084

Instrument: Microphone
Model: 4189
Manufacturer: Brüel & Kjær
Serial number: 2650730
Composed of:

Date Calibrated: 3/4/2021 Cal Due:
Status:

Received	Sent
X	X

In tolerance:

X	X
---	---

Out of tolerance:
See comments:
Contains non-accredited tests: Yes No

Customer: ACI Acoustical Consultants Inc.
Tel/Fax: 780-414-6373/780-414-6376

Address: 5031 - 210 Street, Edmonton,
Alberta, CANADA T6M 0A8

Tested in accordance with the following procedures and standards:
Calibration of Measurement Microphones, Scantek, Inc., Rev. 2/25/2015

Instrumentation used for calibration: N-1504 Norsonic Test System:

Instrument - Manufacturer	Description	S/N	Cal. Date	Traceability-evidence	Cal. Due
				Cal. Lab / Accreditation	
483B-Norsonic	SME Cal Unit	31052	Oct 31, 2020	Scantek, Inc./ NVLAP	Oct 31, 2021
DS-360-SRS	Function Generator	33584	Oct 23, 2019	ACR Env./ A2LA	Oct 23, 2021
34401A-Agilent Technologies	Digital Voltmeter	MY47011118	Feb 4, 2021	ACR Env. / A2LA	Feb 4, 2022
HM30-Thommen	Meteo Station	1040170/39633	Dec 7, 2020	ACR Env./ A2LA	Dec 7, 2021
PC Program 1017 Norsonic	Calibration software	v.6.1T	Validated Nov 2014	Scantek, Inc.	
1253-Norsonic	Calibrator	28326	Oct 26, 2020	Scantek, Inc./ NVLAP	Oct 26, 2021
1203-Norsonic	Preamplifier	14059	March 3, 2021	Scantek, Inc./ NVLAP	March 3, 2022
4180-Brüel&Kjær	Microphone	2246115	Oct 1, 2019	DPLA / DANAK	Oct 1, 2021

Instrumentation and test results are traceable to SI - BIPM through standards maintained by NPL (UK) and NIST (USA)

Calibrated by:	Lydon Dawkins	Authorized signatory:	William D. Gallagher
Signature	<i>Lydon Dawkins</i>	Signature	<i>William D. Gallagher</i>
Date	3/4/2021	Date	3/5/2021

Calibration Certificates or Test Reports shall not be reproduced, except in full, without written approval of the laboratory. This Calibration Certificate or Test Reports shall not be used to claim product certification, approval or endorsement by NVLAP, NIST, or any agency of the federal government.

Document stored as: Y:\Calibration Lab\Mic 2021\B&K4189_2650730_M1.doc

Page 1 of 2

B&K 4231 Unit #6 Calibrator Calibration Certificate

Scantek, Inc.

CALIBRATION LABORATORY

ISO 17025: 2005, ANSI/NCCL Z540:1994 Part 1
ACCREDITED by NVLAP (an ILAC MRA signatory)

NVLAP[®]
CALIBRATION
NVLAP Lab Code: 200625-0

Calibration Certificate No.44315

Instrument: Acoustical Calibrator
Model: 4231
Manufacturer: Brüel and Kjær
Serial number: 2656414
Class (IEC 60942): 1
Barometer type:
Barometer s/n:
Customer: ACI Acoustical Consultants Inc.
Tel/Fax: 780-414-6373 / 780-414-6376

Date Calibrated: 2/3/2020 **Cal Due:**
Status:

Received	Sent
X	X

In tolerance:

X	X
---	---

Out of tolerance:

--	--

See comments:

--	--

Contains non-accredited tests: Yes X No
Address: 5031 - 210 Street
Edmonton, Alberta
CANADA T6M 0A8

Tested in accordance with the following procedures and standards:
Calibration of Acoustical Calibrators, Scantek Inc., Rev. 10/1/2010

Instrumentation used for calibration: Nor-1504 Norsonic Test System:

Instrument - Manufacturer	Description	S/N	Cal. Date	Traceability evidence	Cal. Due
				Cal. Lab / Accreditation	
483B-Norsonic	SME Cal Unit	31061	Jul 31, 2019	Scantek, Inc./ NVLAP	Jul 31, 2020
DS-360-SHS	Function Generator	61646	Sep 7, 2018	ACR Env./ A2LA	Sep 7, 2020
34401A-Agilent Technologies	Digital Voltmeter	MY47022043	Sep 16, 2019	ACR Env./ A2LA	Sep 16, 2020
HM30-Thommen	Meteo Station	1040170/39633	Oct 24, 2019	ACR Env./ A2LA	Oct 24, 2020
140-Norsonic	Real Time Analyzer	1403978	Mar 18, 2019	Scantek, Inc. / NVLAP	Mar 18, 2020
PC Program 1018 Norsonic	Calibration software	v.6.1T	Validated NOV 2014	Scantek, Inc.	-
4192-Brüel&Kjær	Microphone	2854675	Oct 23, 2019	Scantek, Inc. / NVLAP	Oct 23, 2020
1203-Norsonic	Preamplifier	21270	Aug 5, 2019	Scantek, Inc./ NVLAP	Aug 5, 2020

Instrumentation and test results are traceable to SI (International System of Units) through standards maintained by NIST (USA) and NPL (UK)

Calibrated by:	Jeremy Gotwalt	Authorized signatory:	Steven E. Marshall
Signature	<i>Jeremy Gotwalt</i>	Signature	<i>Steven E. Marshall</i>
Date	2/3/2020	Date	2/3/2020

Calibration Certificates or Test Reports shall not be reproduced, except in full, without written approval of the laboratory.
This Calibration Certificate or Test Reports shall not be used to claim product certification, approval or endorsement by NVLAP, NIST, or any agency of the federal government.
Document stored as: Y:\Calibration Lab\Cal 2020\BNK4231_2656414_M1.doc Page 1 of 2

B&K 2250 Unit #7 SLM and Mic Calibration Certificate

CALIBRATED BY TRANSCOT CERTIFICATE OF CALIBRATION



Customer: ACI ACOUSTICAL CONSULTANTS INC
5031-210 STREET NW
EDMONTON, AB T6M 0A8

PO Number: BILAWCHUK

Certificate/ISO Number: 17-Q1X3X-20-1 Revision 0

As-Found: In Tolerance
As-Left: In Tolerance

Manufacturer: Bruel & Kjaer

Model Number: 2250

Description: Sound Level Meter

Serial Number: 2722859/2710791

ID: UNIT #7

Issue Date: Apr 07, 2021
Calibration Date: Apr 07, 2021

Calibrated To: Manufacturer Specification

Calibration Procedure: 1-AC28548-3

Transcot Calibration Laboratories have been audited and found in compliance with ISO/IEC 17025:2017. Accredited calibrations performed within the Lab's Scope of Accreditation are indicated by the presence of the Accrediting Body's Logo and Certificate Number. Any measurements on an accredited calibration not covered by that Lab's Scope of Accreditation are listed in the notes section of the certificate. SCC, NRC, CLAS or ANAB do not guarantee the accuracy of an individual calibration by accredited laboratories.

Transcot calibrations, as applicable, are performed in compliance with the requirements of the Transcot Quality Manual QAC-PQ-1000, the customer's Purchase Order and/or Quality Agreement requirements, ISO 9001:2015, ANSI/NCSL Z540-1:1994 (R2002) or NQA-1, as applicable. Complete records of work performed are maintained by Transcot and are available for inspection. Laboratory standards used in the performance of this calibration are listed on this certificate.

Transcot documents the traceability of measurements to the SI units through the National Institute of Standards and Technology (NIST), or the National Research Council of Canada (NRC), or other national measurement institutes (NMI) via the appropriate measurement, or accepted international and/or national physical constants, or by the use of specified methods, consensus standards or ratio-type measurements. Documentation supporting traceability information is available for review upon written request at a Transcot facility. The measurement uncertainty and the measurement uncertainty are required for further dissemination of traceability.

A binary decision rule, utilizing simple acceptance and simple rejection criteria is used for the determination of compliance, unless otherwise superseded by the client's Decision Rule. When Calibration Tolerance compliance statements are present, they are reported without factoring in the effects of uncertainty and comply with the guidelines established by ASME B89.7.3.1.2001 (R2018), as follows:

- The acceptance zone is defined as: less than or equal to the high calibration tolerance limit, and/or greater than or equal to the low calibration tolerance limit. The rejection zones are defined as greater than the high calibration tolerance limit and/or less than the low calibration tolerance limit.
- Single measurement results in the acceptance zone are identified as in-tolerance. Single measurement results in the rejection zone are identified as out-of-tolerance (OOT).
- When all measurement results are in the acceptance zone for repeated measurements, for the same characteristic, the test is denoted as in-tolerance. For repeated characteristic measurements, a single measurement result in the rejection zone will cause the test to be identified as out-of-tolerance (OOT).

Uncertainties are reported with a coverage factor k=2, providing a level of confidence of approximately 95%. At calibrations have been performed using processes having a TUR of 4:1 or better (3:1 for mass calibrations), unless otherwise noted. The Test Uncertainty Ratio (TUR) is calculated in accordance with NCSL International RP-18. For mass calibrations, conventional mass referenced to 8.0 g/cm³.

The results in this report relate only to the item calibrated or tested. Recorded calibration data is valid at the time of calibration within the stated uncertainties at the environmental conditions noted. The determination of compliance to the specification is specific to the model/serial number referenced above based on the tolerances shown; these tolerances are either the original equipment manufacturer's (OEM's) warrant specifications or the client's requested specifications. This certificate may not be reproduced except in full, without the written approval of Transcot. Additional information, if applicable may be included on separate report(s).

Date Received: March 18, 2021
Service Level: RB

Certificate - Page 1 of 7

Customer Number: 9-330269-000
DPS-F20-014R8 04/07/21 F9014R0 4/2/2021

Appendix II THE ASSESSMENT OF ENVIRONMENTAL NOISE (GENERAL)

Sound Pressure Level

Sound pressure is initially measured in Pascal's (Pa). Humans can hear several orders of magnitude in sound pressure levels, so a more convenient scale is used. This scale is known as the decibel (dB) scale, named after Alexander Graham Bell (telephone guy). It is a base 10 logarithmic scale. When we measure pressure we typically measure the RMS sound pressure.

$$SPL = 10 \log_{10} \left[\frac{P_{RMS}^2}{P_{ref}^2} \right] = 20 \log_{10} \left[\frac{P_{RMS}}{P_{ref}} \right]$$

Where: SPL = Sound Pressure Level in dB
 P_{RMS} = Root Mean Square measured pressure (Pa)
 P_{ref} = Reference sound pressure level ($P_{ref} = 2 \times 10^{-5}$ Pa = 20 μ Pa)

This reference sound pressure level is an internationally agreed upon value. It represents the threshold of human hearing for "typical" people based on numerous testing. It is possible to have a threshold which is lower than 20 μ Pa which will result in negative dB levels. As such, zero dB does not mean there is no sound!

In general, a difference of 1 – 2 dB is the threshold for humans to notice that there has been a change in sound level. A difference of 3 dB (factor of 2 in acoustical energy) is perceptible and a change of 5 dB is strongly perceptible. A change of 10 dB is typically considered a factor of 2. This is quite remarkable when considering that 10 dB is 10-times the acoustical energy!

SOUND PRESSURE

SOUND PRESSURE LEVEL

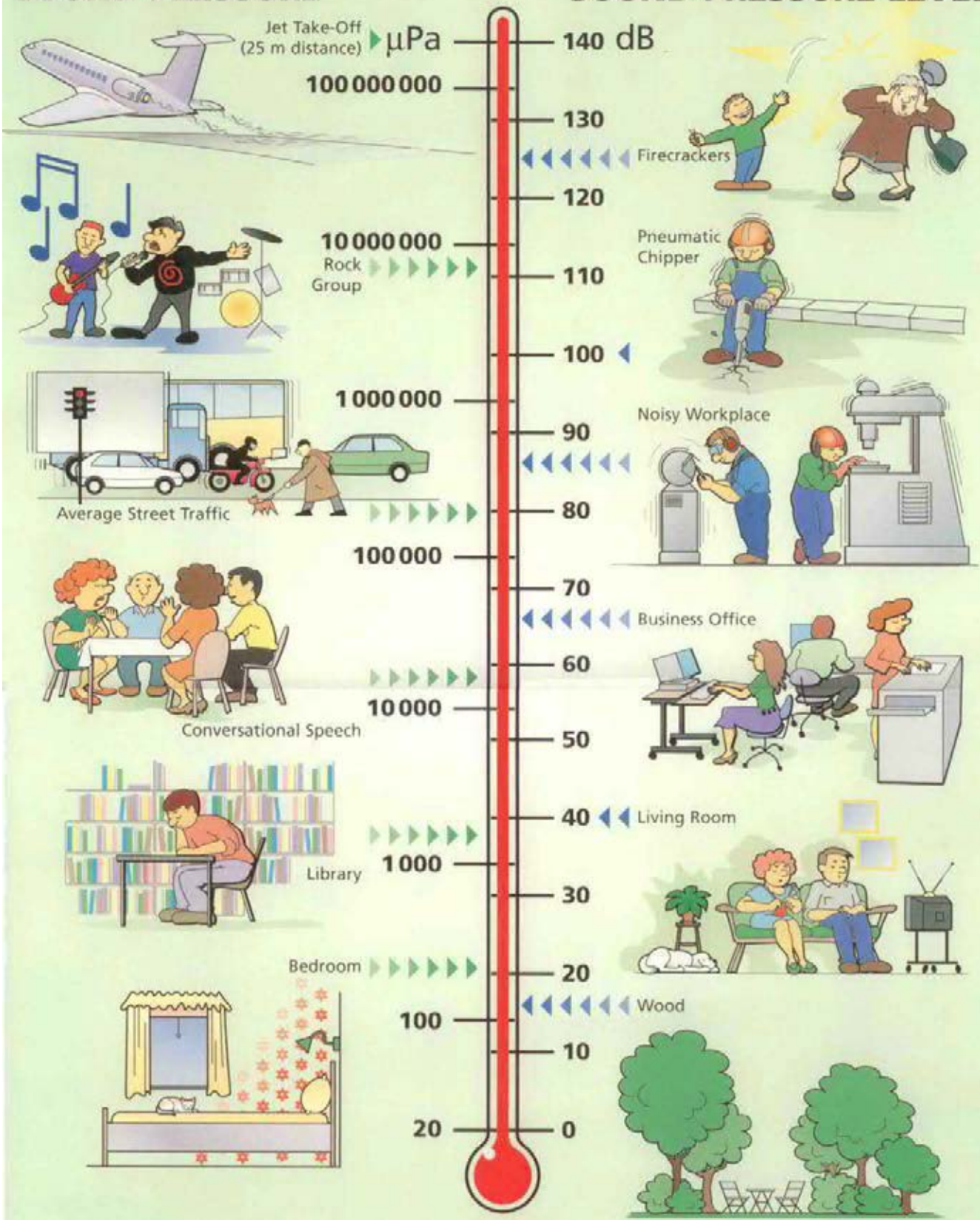

Frequency

The range of frequencies audible to the human ear ranges from approximately 20 Hz to 20 kHz. Within this range, the human ear does not hear equally at all frequencies. It is not very sensitive to low frequency sounds, is very sensitive to mid frequency sounds and is slightly less sensitive to high frequency sounds. Due to the large frequency range of human hearing, the entire spectrum is often divided into 31 bands, each known as a 1/3 octave band.

The internationally agreed upon center frequencies and upper and lower band limits for the 1/1 (whole octave) and 1/3 octave bands are as follows:

<u>Whole Octave</u>			<u>1/3 Octave</u>		
Lower Band Limit	Center Frequency	Upper Band Limit	Lower Band Limit	Center Frequency	Upper Band Limit
11	16	22	14.1	16	17.8
			17.8	20	22.4
22	31.5	44	22.4	25	28.2
			28.2	31.5	35.5
			35.5	40	44.7
44	63	88	44.7	50	56.2
			56.2	63	70.8
			70.8	80	89.1
88	125	177	89.1	100	112
			112	125	141
			141	160	178
177	250	355	178	200	224
			224	250	282
			282	315	355
355	500	710	355	400	447
			447	500	562
			562	630	708
710	1000	1420	708	800	891
			891	1000	1122
			1122	1250	1413
1420	2000	2840	1413	1600	1778
			1778	2000	2239
			2239	2500	2818
2840	4000	5680	2818	3150	3548
			3548	4000	4467
			4467	5000	5623
5680	8000	11360	5623	6300	7079
			7079	8000	8913
			8913	10000	11220
11360	16000	22720	11220	12500	14130
			14130	16000	17780
			17780	20000	22390

Human hearing is most sensitive at approximately 3500 Hz which corresponds to the ¼ wavelength of the ear canal (approximately 2.5 cm). Because of this range of sensitivity to various frequencies, we typically apply various weighting networks to the broadband measured sound to more appropriately account for the way humans hear. By default, the most common weighting network used is the so-called “A-weighting”. It can be seen in the figure that the low frequency sounds are reduced significantly with the A-weighting.

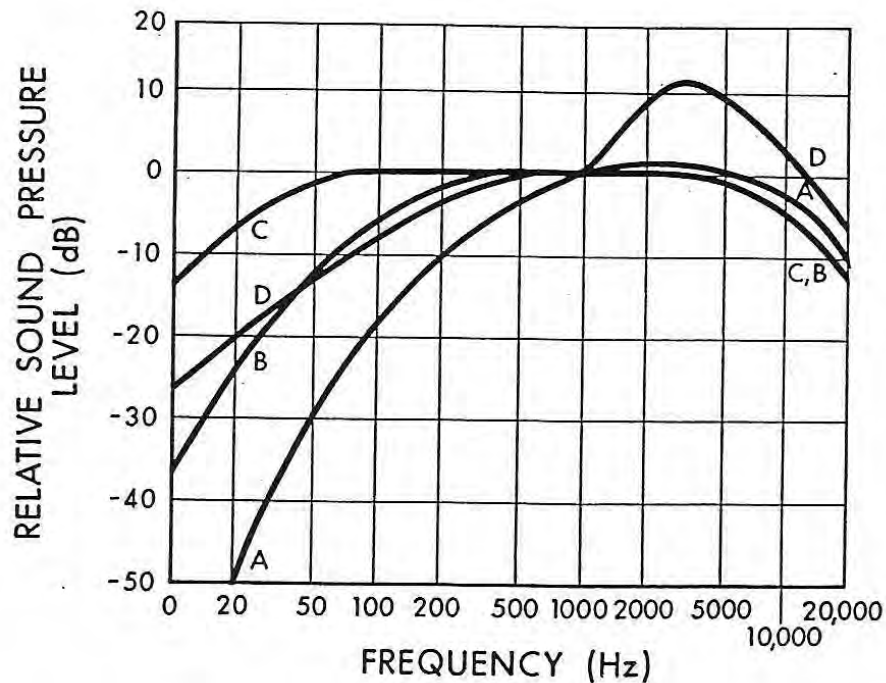

Combination of Sounds

When combining multiple sound sources the general equation is:

$$\Sigma SPL_n = 10 \log_{10} \left[\sum_{i=1}^n 10^{\frac{SPL_i}{10}} \right]$$

Examples:

- Two sources of 50 dB each add together to result in 53 dB.
- Three sources of 50 dB each add together to result in 55 dB.
- Ten sources of 50 dB each add together to result in 60 dB.
- One source of 50 dB added to another source of 40 dB results in 50.4 dB

It can be seen that, if multiple similar sources exist, removing or reducing only one source will have little effect.

Sound Level Measurements

Over the years a number of methods for measuring and describing environmental noise have been developed. The most widely used and accepted is the concept of the Energy Equivalent Sound Level (L_{eq}) which was developed in the US (1970's) to characterize noise levels near US Air-force bases. This is the level of a steady state sound which, for a given period of time, would contain the same energy as the time varying sound. The concept is that the same amount of annoyance occurs from a sound having a high level for a short period of time as from a sound at a lower level for a longer period of time.

The L_{eq} is defined as:

$$L_{eq} = 10 \log_{10} \left[\frac{1}{T} \int_0^T 10^{\frac{dB}{10}} dT \right] = 10 \log_{10} \left[\frac{1}{T} \int_0^T \frac{P^2}{P_{ref}^2} dT \right]$$

We must specify the time period over which to measure the sound. i.e. 1-second, 10-seconds, 15-seconds, 1-minute, 1-day, etc. **An L_{eq} is meaningless if there is no time period associated.**

In general there are a few very common L_{eq} sample durations which are used in describing environmental noise measurements. These include:

- L_{eq24} - Measured over a 24-hour period
- $L_{eqNight}$ - Measured over the night-time (typically 22:00 – 07:00)
- L_{eqDay} - Measured over the day-time (typically 07:00 – 22:00)
- L_{DN} - Same as L_{eq24} with a 10 dB penalty added to the night-time

Statistical Descriptor

Another method of conveying long term noise levels utilizes statistical descriptors. These are calculated from a cumulative distribution of the sound levels over the entire measurement duration and then determining the sound level at xx % of the time.

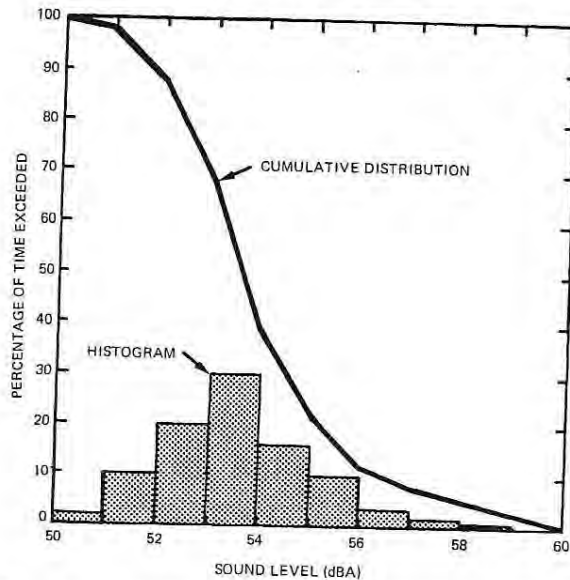

Figure 16.6 Statistically processed community noise showing histogram and cumulative distribution of A weighted sound levels.

Industrial Noise Control, Lewis Bell, Marcel Dekker, Inc. 1994

The most common statistical descriptors are:

- L_{\min} - minimum sound level measured
- L_{01} - sound level that was exceeded only 1% of the time
- L_{10} - sound level that was exceeded only 10% of the time.
 - Good measure of intermittent or intrusive noise
 - Good measure of Traffic Noise
- L_{50} - sound level that was exceeded 50% of the time (arithmetic average)
 - Good to compare to L_{eq} to determine steadiness of noise
- L_{90} - sound level that was exceeded 90% of the time
 - Good indicator of typical “ambient” noise levels
- L_{99} - sound level that was exceeded 99% of the time
- L_{\max} - maximum sound level measured

These descriptors can be used to provide a more detailed analysis of the varying noise climate:

- If there is a large difference between the L_{eq} and the L_{50} (L_{eq} can never be any lower than the L_{50}) then it can be surmised that one or more short duration, high level sound(s) occurred during the time period.
- If the gap between the L_{10} and L_{90} is relatively small (less than 15 – 20 dBA) then it can be surmised that the noise climate was relatively steady.

Sound Propagation

In order to understand sound propagation, the nature of the source must first be discussed. In general, there are three types of sources. These are known as 'point', 'line', and 'area'. This discussion will concentrate on point and line sources since area sources are much more complex and can usually be approximated by point sources at large distances.

Point Source

As sound radiates from a point source, it dissipates through geometric spreading. The basic relationship between the sound levels at two distances from a point source is:

$$\therefore SPL_1 - SPL_2 = 20 \log_{10} \left(\frac{r_2}{r_1} \right)$$

Where: SPL_1 = sound pressure level at location 1, SPL_2 = sound pressure level at location 2
 r_1 = distance from source to location 1, r_2 = distance from source to location 2

Thus, the reduction in sound pressure level for a point source radiating in a free field is **6 dB per doubling of distance**. This relationship is independent of reflectivity factors provided they are always present. Note that this only considers geometric spreading and does not take into account atmospheric effects. Point sources still have some physical dimension associated with them, and typically do not radiate sound equally in all directions in all frequencies. The directionality of a source is also highly dependent on frequency. As frequency increases, directionality increases.

Examples (note no atmospheric absorption):

- A point source measuring 50 dB at 100m will be 44 dB at 200m.
- A point source measuring 50 dB at 100m will be 40.5 dB at 300m.
- A point source measuring 50 dB at 100m will be 38 dB at 400m.
- A point source measuring 50 dB at 100m will be 30 dB at 1000m.

Line Source

A line source is similar to a point source in that it dissipates through geometric spreading. The difference is that a line source is equivalent to a long line of many point sources. The basic relationship between the sound levels at two distances from a line source is:

$$SPL_1 - SPL_2 = 10 \log_{10} \left(\frac{r_2}{r_1} \right)$$

The difference from the point source is that the '20' term in front of the 'log' is now only 10. Thus, the reduction in sound pressure level for a line source radiating in a free field is **3 dB per doubling of distance**.

Examples (note no atmospheric absorption):

- A line source measuring 50 dB at 100m will be 47 dB at 200m.
- A line source measuring 50 dB at 100m will be 45 dB at 300m.
- A line source measuring 50 dB at 100m will be 44 dB at 400m.
- A line source measuring 50 dB at 100m will be 40 dB at 1000m.

Atmospheric Absorption

As sound transmits through a medium, there is an attenuation (or dissipation of acoustic energy) which can be attributed to three mechanisms:

- 1) **Viscous Effects** - Dissipation of acoustic energy due to fluid friction which results in thermodynamically irreversible propagation of sound.
- 2) **Heat Conduction Effects** - Heat transfer between high and low temperature regions in the wave which result in non-adiabatic propagation of the sound.
- 3) **Inter Molecular Energy Interchanges** - Molecular energy relaxation effects which result in a time lag between changes in translational kinetic energy and the energy associated with rotation and vibration of the molecules.

The following table illustrates the attenuation coefficient of sound at standard pressure (101.325 kPa) in units of dB/100m.

Temperature °C	Relative Humidity (%)	Frequency (Hz)					
		125	250	500	1000	2000	4000
30	20	0.06	0.18	0.37	0.64	1.40	4.40
	50	0.03	0.10	0.33	0.75	1.30	2.50
	90	0.02	0.06	0.24	0.70	1.50	2.60
20	20	0.07	0.15	0.27	0.62	1.90	6.70
	50	0.04	0.12	0.28	0.50	1.00	2.80
	90	0.02	0.08	0.26	0.56	0.99	2.10
10	20	0.06	0.11	0.29	0.94	3.20	9.00
	50	0.04	0.11	0.20	0.41	1.20	4.20
	90	0.03	0.10	0.21	0.38	0.81	2.50
0	20	0.05	0.15	0.50	1.60	3.70	5.70
	50	0.04	0.08	0.19	0.60	2.10	6.70
	90	0.03	0.08	0.15	0.36	1.10	4.10

- As frequency increases, absorption tends to increase
- As Relative Humidity increases, absorption tends to decrease
- There is no direct relationship between absorption and temperature
- **The net result of atmospheric absorption is to modify the sound propagation of a point source from 6 dB/doubling-of-distance to approximately 7 – 8 dB/doubling-of-distance (based on anecdotal experience)**

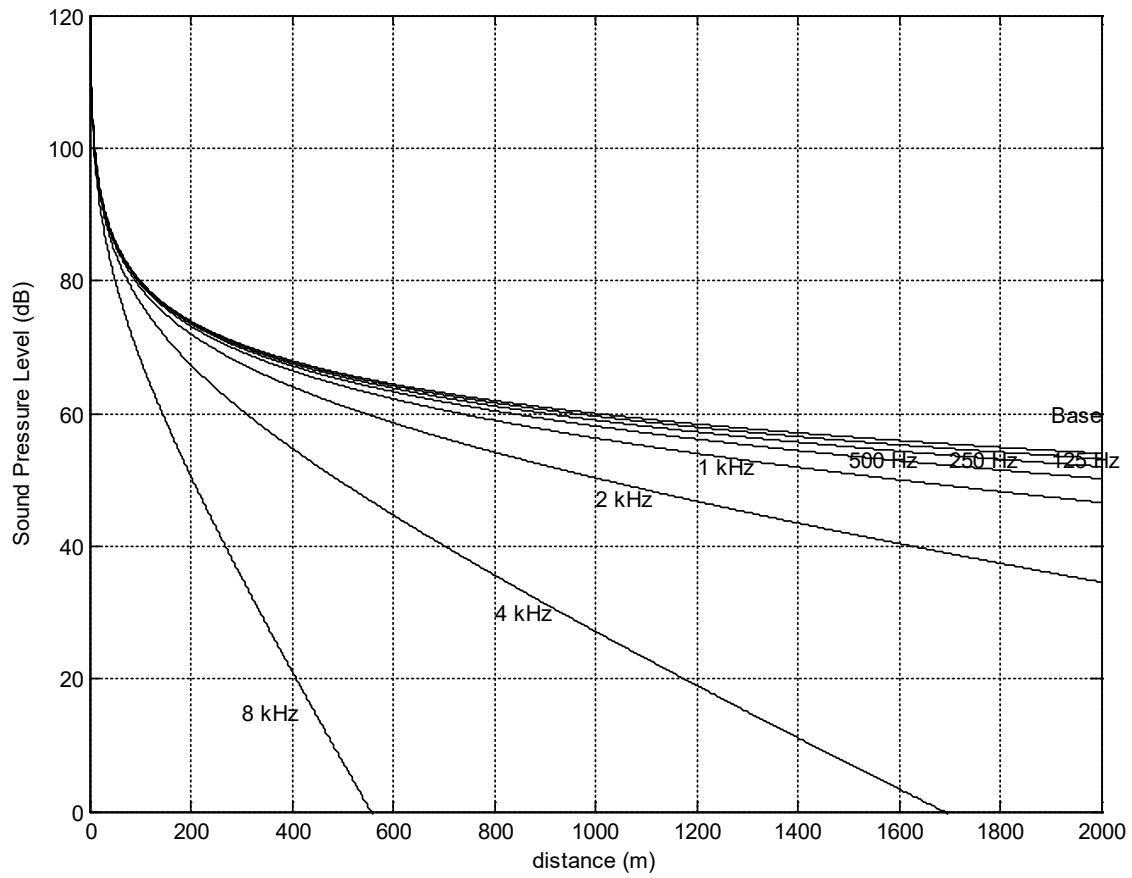

Atmospheric Absorption at 10°C and 70% RH

DRY

Meteorological Effects

There are many meteorological factors which can affect how sound propagates over large distances. These various phenomena must be considered when trying to determine the relative impact of a noise source either after installation or during the design stage.

Wind

- Can greatly alter the noise climate away from a source depending on direction
- Sound levels downwind from a source can be increased due to refraction of sound back down towards the surface. This is due to the generally higher velocities as altitude increases.
- Sound levels upwind from a source can be decreased due to a “bending” of the sound away from the earth’s surface.
- Sound level differences of ± 10 dB are possible depending on severity of wind and distance from source.
- Sound levels crosswind are generally not disturbed by an appreciable amount
- Wind tends to generate its own noise, however, and can provide a high degree of masking relative to a noise source of particular interest.

Temperature

- Temperature effects can be similar to wind effects
- Typically, the temperature is warmer at ground level than it is at higher elevations.
- If there is a very large difference between the ground temperature (very warm) and the air aloft (only a few hundred meters) then the transmitted sound refracts upward due to the changing speed of sound.
- If the air aloft is warmer than the ground temperature (known as an *inversion*) the resulting higher speed of sound aloft tends to refract the transmitted sound back down towards the ground. This essentially works on Snell’s law of reflection and refraction.
- Temperature inversions typically happen early in the morning and are most common over large bodies of water or across river valleys.
- Sound level differences of ± 10 dB are possible depending on gradient of temperature and distance from source.

Rain

- Rain does not affect sound propagation by an appreciable amount unless it is very heavy
- The larger concern is the noise generated by the rain itself. A heavy rain striking the ground can cause a significant amount of highly broadband noise. The amount of noise generated is difficult to predict.
- Rain can also affect the output of various noise sources such as vehicle traffic.

Summary

- In general, these wind and temperature effects are difficult to predict
- Empirical models (based on measured data) have been generated to attempt to account for these effects.
- Environmental noise measurements must be conducted with these effects in mind. Sometimes it is desired to have completely calm conditions, other times a “worst case” of downwind noise levels are desired.

Topographical Effects

Similar to the various atmospheric effects outlined in the previous section, the effect of various geographical and vegetative factors must also be considered when examining the propagation of noise over large distances.

Topography

- One of the most important factors in sound propagation.
- Can provide a natural barrier between source and receiver (i.e. if berm or hill in between).
- Can provide a natural amplifier between source and receiver (i.e. large valley in between or hard reflective surface in between).
- Must look at location of topographical features relative to source and receiver to determine importance (i.e. small berm 1km away from source and 1km away from receiver will make negligible impact).

Grass

- Can be an effective absorber due to large area covered
- Only effective at low height above ground. Does not affect sound transmitted direct from source to receiver if there is line of sight.
- Typically less absorption than atmospheric absorption when there is line of sight.
- Approximate rule of thumb based on empirical data is:

$$A_g = 18 \log_{10}(f) - 31 \quad (dB/100m)$$

Where: A_g is the absorption amount

Trees

- Provide absorption due to foliage
- Deciduous trees are essentially ineffective in the winter
- Absorption depends heavily on density and height of trees
- No data found on absorption of various kinds of trees
- Large spans of trees are required to obtain even minor amounts of sound reduction
- In many cases, trees can provide an effective visual barrier, even if the noise attenuation is negligible.

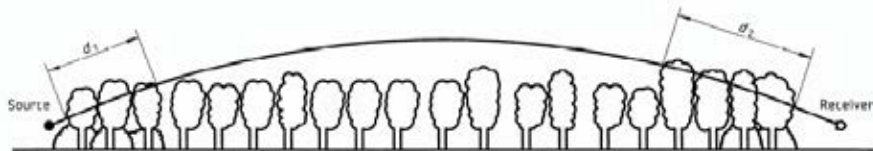

NOTE — $d_1 = d_1 + d_2$

For calculating d_1 and d_2 , the curved path radius may be assumed to be 5 km.

Figure A.1 — Attenuation due to propagation through foliage increases linearly with propagation distance d_1 through the foliage

Table A.1 — Attenuation of an octave band of noise due to propagation a distance d_1 through dense foliage

Propagation distance d_1 m	Nominal midband frequency Hz								
	63	125	250	500	1 000	2 000	4 000	8 000	
$10 \leq d_1 \leq 20$	Attenuation, dB: 0		1	1	1	1	2	3	
$20 \leq d_1 \leq 200$	Attenuation, dB/m: 0.02		0.03	0.04	0.05	0.06	0.08	0.09	0.12

Tree/Foliage attenuation from ISO 9613-2:1996

Bodies of Water

- Large bodies of water can provide the opposite effect to grass and trees.
- Reflections caused by small incidence angles (grazing) can result in larger sound levels at great distances (increased reflectivity, Q).
- Typically air temperatures are warmer high aloft since air temperatures near water surface tend to be more constant. Result is a high probability of temperature inversion.
- Sound levels can “carry” much further.

Snow

- Covers the ground for much of the year in northern climates.
- Can act as an absorber or reflector (and varying degrees in between).
- Freshly fallen snow can be quite absorptive.
- Snow which has been sitting for a while and hard packed due to wind can be quite reflective.
- Falling snow can be more absorptive than rain, but does not tend to produce its own noise.
- Snow can cover grass which might have provided some means of absorption.
- Typically sound propagates with less impedance in winter due to hard snow on ground and no foliage on trees/shrubs.

Appendix III SOUND LEVELS OF FAMILIAR NOISE SOURCES

Used with Permission Obtained from ERCB Directive 038 (2007)

Source ¹	Sound Level (dBA)
Bedroom of a country home	30
Soft whisper at 1.5 m	30
Quiet office or living room	40
Moderate rainfall	50
Inside average urban home	50
Quiet street	50
Normal conversation at 1 m	60
Noisy office	60
Noisy restaurant	70
Highway traffic at 15 m	75
Loud singing at 1 m	75
Tractor at 15 m	78-95
Busy traffic intersection	80
Electric typewriter	80
Bus or heavy truck at 15 m	88-94
Jackhammer	88-98
Loud shout	90
Freight train at 15 m	95
Modified motorcycle	95
Jet taking off at 600 m	100
Amplified rock music	110
Jet taking off at 60 m	120
Air-raid siren	130

¹ Cottrell, Tom, 1980, *Noise in Alberta*, Table 1, p.8, ECA80 - 16/1B4 (Edmonton: Environment Council of Alberta).

SOUND LEVELS GENERATED BY COMMON APPLIANCES

Used with Permission Obtained from ERCB Directive 038 (2007)

Source ¹	Sound level at 3 feet (dBA)
Freezer	38-45
Refrigerator	34-53
Electric heater	47
Hair clipper	50
Electric toothbrush	48-57
Humidifier	41-54
Clothes dryer	51-65
Air conditioner	50-67
Electric shaver	47-68
Water faucet	62
Hair dryer	58-64
Clothes washer	48-73
Dishwasher	59-71
Electric can opener	60-70
Food mixer	59-75
Electric knife	65-75
Electric knife sharpener	72
Sewing machine	70-74
Vacuum cleaner	65-80
Food blender	65-85
Coffee mill	75-79
Food waste disposer	69-90
Edger and trimmer	81
Home shop tools	64-95
Hedge clippers	85
Electric lawn mower	80-90

¹ Reif, Z. F., and Vermeulen, P. J., 1979, "Noise from domestic appliances, construction, and industry," Table 1, p.166, in Jones, H. W., ed., *Noise in the Human Environment*, vol. 2, ECA79-SP/1 (Edmonton: Environment Council of Alberta).

Appendix IV NOISE MODELLING PARAMETERS

Current Conditions (Year 2020)

Road	Day (Vehicles Per Hour)	Day % Heavy Vehicles	Night (Vehicles Per Hour)	Night % Heavy Vehicles	Speed (km/hr)	Total Volume (vehicles per day)
Whitemud Drive - North of Fox Drive (NB)	3701	6.1	681	6.1	80	61639
Whitemud Drive - North of Fox Drive (SB)	3668	6.2	675	6.2	80	61099
Whitemud Drive - North of 53 Avenue (NB)	2894	6.1	532	6.1	80	48199
Whitemud Drive - North of 53 Avenue (SB)	2948	6.2	542	6.2	80	49100
Whitemud Drive - North of Terwillegar (NB)	2842	6.7	523	6.7	80	47331
Whitemud Drive - North of Terwillegar (SB)	2842	6.4	523	6.4	80	47331
Whitemud Drive - West of 122 Street (WB)	2693	6.7	495	6.7	80	44851
Whitemud Drive - West of 122 Street (EB)	2703	6.4	497	6.4	80	45024
Whitemud Drive - East of 122 Street (NB)	2566	3.6	472	3.6	80	42736
Whitemud Drive - East of 122 Street (SB)	2566	2.7	472	2.7	80	42736
Fox Drive (WB) to Whitemud Drive (NB)	792	3.6	146	3.6	60	13188
Fox Drive (WB) to Whitemud Drive (SB)	343	2.7	63	2.7	60	5716
Whitemud Drive (SB) to Fox Drive (EB)	930	3.6	171	3.6	50	15482
Whitemud Drive (NB) to Fox Drive (EB)	135	2.7	25	2.7	50	2241
53 Avenue - West of Whitemud Drive (WB)	101	3.0	19	3.0	50	1688
53 Avenue - West of Whitemud Drive (EB)	402	3.0	74	3.0	50	6701
53 Avenue - East of Whitemud Drive (WB)	103	3.0	19	3.0	50	1718
53 Avenue - East of Whitemud Drive (EB)	82	3.0	15	3.0	50	1360
53 Avenue (WB) to Whitemud Drive (NB)	59	3.0	11	3.0	50	984
53 Avenue (EB) to Whitemud Drive (NB)	369	3.0	68	3.0	50	6148
Whitemud Drive (SB) to 53 Avenue (EB)	326	3.0	60	3.0	50	5423
Whitemud Drive (SB) to 53 Avenue (WB)	167	3.0	31	3.0	50	2785
53 Avenue (WB) to Whitemud Drive (SB)	55	3.0	10	3.0	50	920
53 Avenue (EB) to Whitemud Drive (SB)	123	3.0	23	3.0	50	2042
Whitemud Drive (NB) to 53 Avenue (EB)	41	3.0	8	3	50	686
Whitemud Drive (NB) to 53 Avenue (WB)	137	3.0	25	3	50	2284
Whitemud Drive (SB) to Terwillegar Drive (SB)	720	1.1	132	1.1	60	11986
Whitemud Drive (WB) to Terwillegar Drive (SB)	900	1.1	166	1.1	70	14994
Terwillegar Drive (NB) to Whitemud Drive (NB)	837	1.1	154	1.1	60	13947
Terwillegar Drive (NB) to Whitemud Drive (EB)	934	1.0	172	1.0	70	15557
122 Street - North of Whitemud Drive (NB)	486	3.0	89	3.0	50	8091
122 Street - North of Whitemud Drive (SB)	486	3.0	89	3.0	50	8091
122 Street - South of Whitemud Drive (NB)	588	3.0	108	3.0	50	9790
122 Street - South of Whitemud Drive (SB)	588	3.0	108	3.0	50	9790
122 Street (SB) to Whitemud Drive (WB)	465	3.0	86	3.0	50	7752
122 Street (SB) to Whitemud Drive (EB)	75	3.0	14	3.0	50	1252
Whitemud Drive (EB) to 122 Street (NB)	298	3.0	55	3.0	50	4963
Whitemud Drive (EB) to 122 Street (SB)	155	3.0	29	3.0	50	2580
122 Street (NB) to Whitemud Drive (WB)	277	3.0	51	3.0	50	4619
122 Street (NB) to Whitemud Drive (EB)	186	3.0	34	3.0	50	3104
Whitemud Drive (WB) to 122 Street (NB)	147	3.0	27	3.0	50	2449
Whitemud Drive (WB) to 122 Street (SB)	87	3.0	16	3.0	50	1442
Collector Road	483	2	128	2	50	8397
Residential Streets	12	3	2	3	50	200

Future Conditions (Year 2050)

Road	Day (Vehicles Per Hour)	Day % Heavy Vehicles	Night (Vehicles Per Hour)	Night % Heavy Vehicles	Speed (km/hr)	Total Volume (vehicles per day)
Whitemud Drive - North of Fox Drive (NB)	5144	6.1	947	6.1	80	85682
Whitemud Drive - North of Fox Drive (SB)	5099	6.2	938	6.2	80	84932
Whitemud Drive - North of 53 Avenue (NB)	4023	6.1	740	6.1	80	66999
Whitemud Drive - North of 53 Avenue (SB)	4203	6.2	773	6.2	80	70006
Whitemud Drive - North of Terwillegar (NB)	3040	6.7	559	6.7	80	50634
Whitemud Drive - North of Terwillegar (SB)	3036	6.4	559	6.4	80	50574
Whitemud Drive - West of 122 Street (WB)	4345	6.7	799	6.7	80	72365
Whitemud Drive - West of 122 Street (EB)	4937	6.4	909	6.4	80	82237
Whitemud Drive - East of 122 Street (NB)	3886	3.6	715	3.6	80	64725
Whitemud Drive - East of 122 Street (SB)	4550	2.7	837	2.7	60	75791
Fox Drive (WB) to Whitemud Drive (NB)	1006	3.6	185	3.6	60	16756
Fox Drive (WB) to Whitemud Drive (SB)	353	2.7	65	2.7	60	5875
Whitemud Drive (SB) to Fox Drive (EB)	1292	3.6	238	3.6	60	21521
Whitemud Drive (NB) to Fox Drive (EB)	187	2.7	34	2.7	60	3115
53 Avenue - West of Whitemud Drive (WB)	141	3.0	26	3.0	50	2347
53 Avenue - West of Whitemud Drive (EB)	559	3.0	103	3.0	50	9314
53 Avenue - East of Whitemud Drive (WB)	143	3.0	26	3.0	60	2389
53 Avenue - East of Whitemud Drive (EB)	113	3.0	21	3.0	50	1890
53 Avenue (WB) to Whitemud Drive (NB)	82	3.0	15	3.0	50	1368
53 Avenue (EB) to Whitemud Drive (NB)	513	3.0	94	3.0	50	8546
Whitemud Drive (SB) to 53 Avenue (EB)	453	3.0	83	3.0	50	7538
Whitemud Drive (SB) to 53 Avenue (WB)	232	3.0	43	3.0	50	3871
53 Avenue (WB) to Whitemud Drive (SB)	77	3.0	14	3.0	50	1278
53 Avenue (EB) to Whitemud Drive (SB)	170	3.0	31	3.0	60	2839
Whitemud Drive (NB) to 53 Avenue (EB)	57	3.0	11	3.0	50	954
Whitemud Drive (NB) to 53 Avenue (WB)	191	3.0	35	3.0	50	3175
Whitemud Drive (SB) to Terwillegar Drive (SB)	1119	1.1	206	1.1	60	18646
Whitemud Drive (WB) to Terwillegar Drive (SB)	1251	1.1	230	1.1	60	20843
Terwillegar Drive (NB) to Whitemud Drive (NB)	968	1.1	178	1.1	60	16126
Terwillegar Drive (NB) to Whitemud Drive (EB)	1901	1.0	350	1.0	70	31663
122 Street - North of Whitemud Drive (NB)	1250	3.0	230	3.0	60	20825
122 Street - North of Whitemud Drive (SB)	990	3.0	182	3.0	50	16486
122 Street - South of Whitemud Drive (NB)	1281	3.0	236	3.0	60	21335
122 Street - South of Whitemud Drive (SB)	876	3.0	161	3.0	60	14583
122 Street (SB) to Whitemud Drive (WB)	763	3.0	140	3.0	60	12711
122 Street (SB) to Whitemud Drive (EB)	123	3.0	23	3.0	50	2052
Whitemud Drive (EB) to 122 Street (NB)	489	3.0	90	3.0	50	8138
Whitemud Drive (EB) to 122 Street (SB)	254	3.0	47	3.0	60	4231
122 Street (NB) to Whitemud Drive (WB)	455	3.0	84	3.0	50	7574
122 Street (NB) to Whitemud Drive (EB)	306	3.0	56	3.0	60	5089
Whitemud Drive (WB) to 122 Street (NB)	241	3.0	44	3.0	60	4015
Whitemud Drive (WB) to 122 Street (SB)	142	3.0	26	3.0	60	2365
Collector Road	483	2.0	128	2.0	50	8397
Residential Streets	12	3.0	2	3.0	50	200

Appendix V DATA REMOVAL

Data Removal Noise Monitoring Location #1

Start Time	End Time	Duration (min)	Reason
4/19/21 18:25	4/19/21 18:26	1	Emergency Sirens
4/19/21 19:11	4/19/21 19:11	0.5	Loud Vehicle Passby
4/19/21 23:09	4/19/21 23:10	1	Loud Vehicle Passby
4/20/21 4:58	4/20/21 4:58	0.75	Loud Vehicle Passby
4/20/21 12:01	4/20/21 12:01	0.75	Emergency Sirens
4/20/21 17:42	4/20/21 17:43	0.75	Loud Vehicle Passby
Total Data		4.75	

Data Removal Noise Monitoring Location #2

Start Time	End Time	Duration (min)	Reason
4/20/21 12:01	4/20/21 12:02	1.25	Loud Vehicle Pass-by

Data Removal Noise Monitoring Location #3

Start Time	End Time	Duration (min)	Reason
4/22/21 8:08	4/22/21 8:13	5.25	Loud Vehicle Passby
4/22/21 9:59	4/22/21 10:00	1.5	Loud Vehicle Passby
4/22/21 10:08	4/22/21 10:09	1	Loud Vehicle Passby
4/22/21 10:39	4/22/21 10:40	1.25	Loud Vehicle Passby
4/22/21 13:55	4/22/21 13:57	1.25	Dog Barking
4/22/21 14:20	4/22/21 14:21	1.5	Dog Barking
4/22/21 14:23	4/22/21 14:24	1.5	Emergency Sirens
4/22/21 14:26	4/22/21 14:28	1.5	Dog Barking
4/22/21 15:57	4/22/21 16:00	3	Human Activity
4/22/21 16:03	4/22/21 16:05	2	Dog Barking
4/22/21 16:16	4/22/21 16:18	1.5	Dog Barking
4/22/21 16:18	4/22/21 16:21	2.5	Dog Barking
4/22/21 16:29	4/22/21 16:30	0.75	Dog Barking
4/22/21 16:30	4/22/21 16:33	2.25	Dog Barking
4/22/21 16:45	4/22/21 16:47	2.5	Dog Barking
4/22/21 16:49	4/22/21 16:51	2.25	Aircraft Flyover
4/22/21 17:34	4/22/21 17:35	1	Emergency Sirens
4/22/21 17:40	4/22/21 17:42	2.25	Dog Barking
4/22/21 17:43	4/22/21 17:45	1.25	Dog Barking
4/22/21 17:50	4/22/21 17:50	0.5	Dog Barking
4/22/21 18:02	4/22/21 18:02	0.75	Emergency Sirens
4/22/21 18:51	4/22/21 18:52	0.75	Dog Barking
4/22/21 19:21	4/22/21 19:22	1.5	Dog Barking
4/22/21 19:33	4/22/21 19:35	2.25	Dog Barking

4/22/21 19:44	4/22/21 19:45	0.75	Dog Barking
4/22/21 19:45	4/22/21 19:49	4	Dog Barking
4/22/21 20:52	4/22/21 20:53	1	Dog Barking
4/22/21 20:54	4/22/21 21:00	5.5	Dog Barking
4/22/21 21:04	4/22/21 21:06	2.25	Aircraft Flyover
4/22/21 21:10	4/22/21 21:12	2	Dog Barking
4/22/21 21:21	4/22/21 21:21	0.5	Dog Barking
4/22/21 21:42	4/22/21 21:43	1	Dog Barking
Total Data		58.75	

Data Removal Noise Monitoring Location #4

Start Time	End Time	Duration (min)	Reason
4/26/21 23:06	4/26/21 23:10	4	Loud Vehicle Passby
4/27/21 8:17	4/27/21 8:24	7.25	Human Activity
4/27/21 8:30	4/27/21 8:52	22.25	Human Activity
4/27/21 18:16	4/27/21 18:18	2	Loud Vehicle Passby
4/27/21 18:32	4/27/21 18:33	1.75	Loud Vehicle Passby
4/27/21 18:48	4/27/21 18:50	2.5	Loud Vehicle Passby
Total Data		39.75	

Appendix VI WEATHER DATA

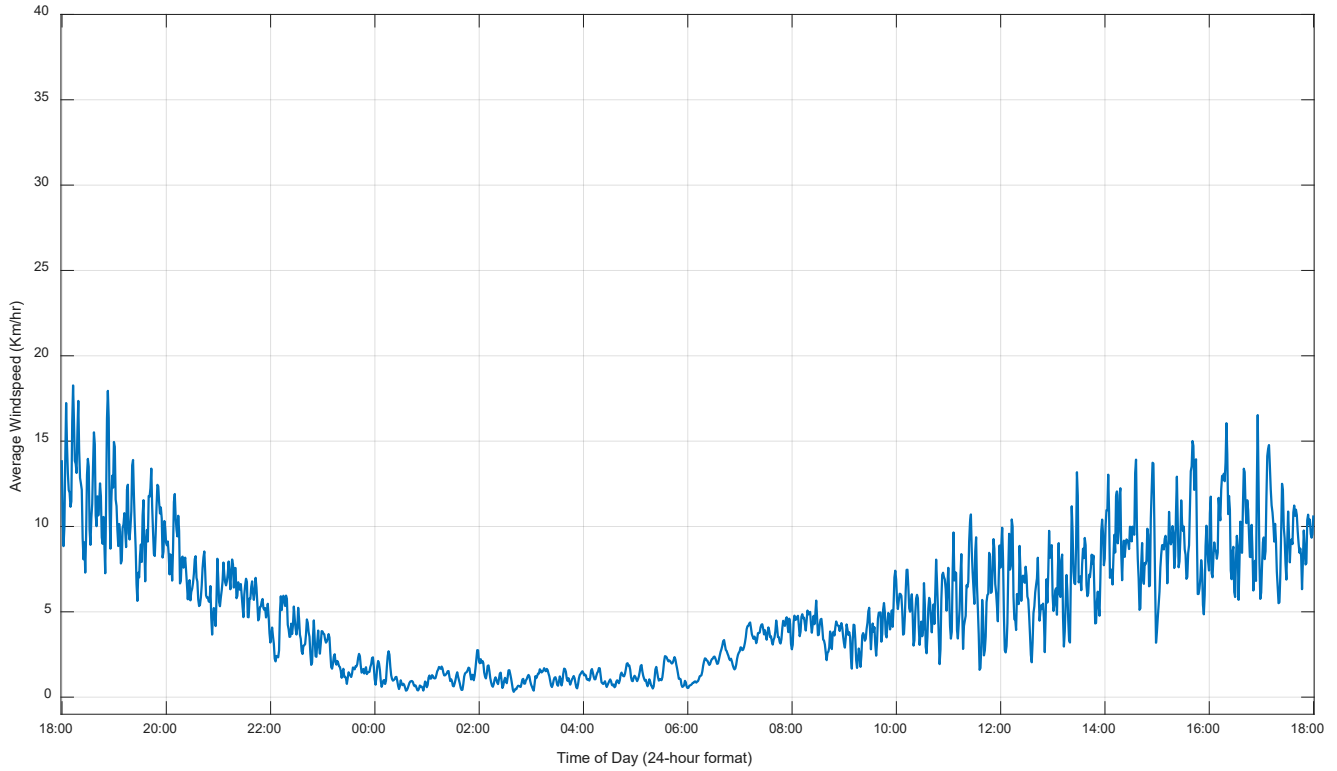

April 19 - 20, 2021 – Monitored Wind Speed

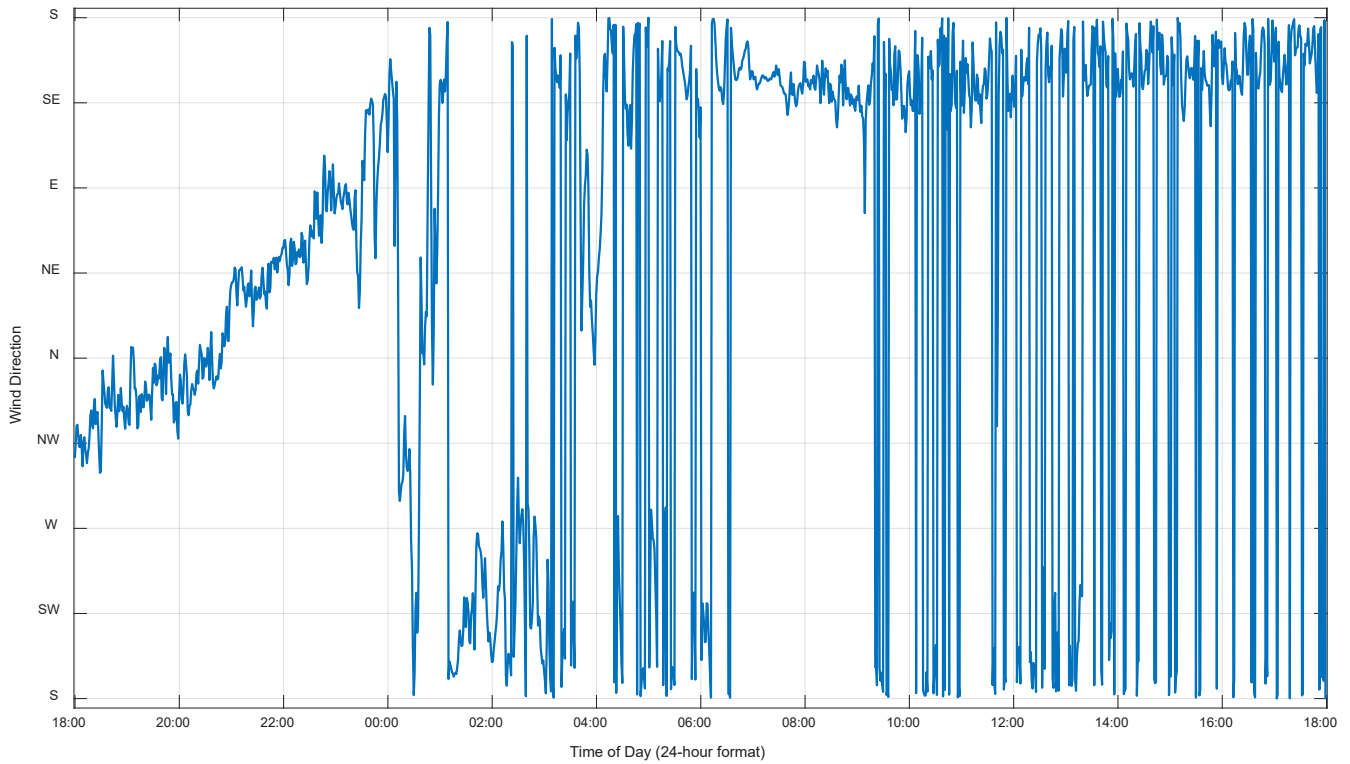

April 19 - 20, 2021 – Monitored Wind Direction

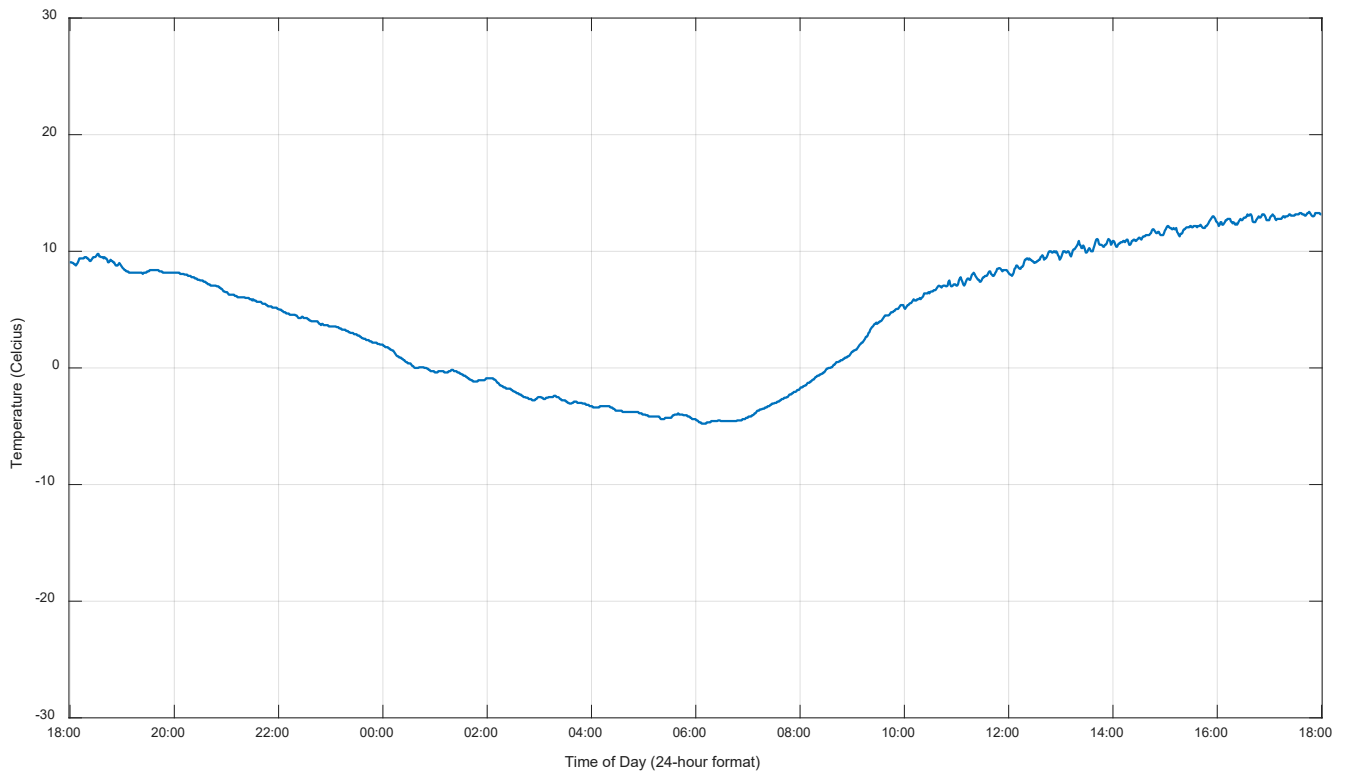

April 19 - 20, 2021 – Monitored Temperature

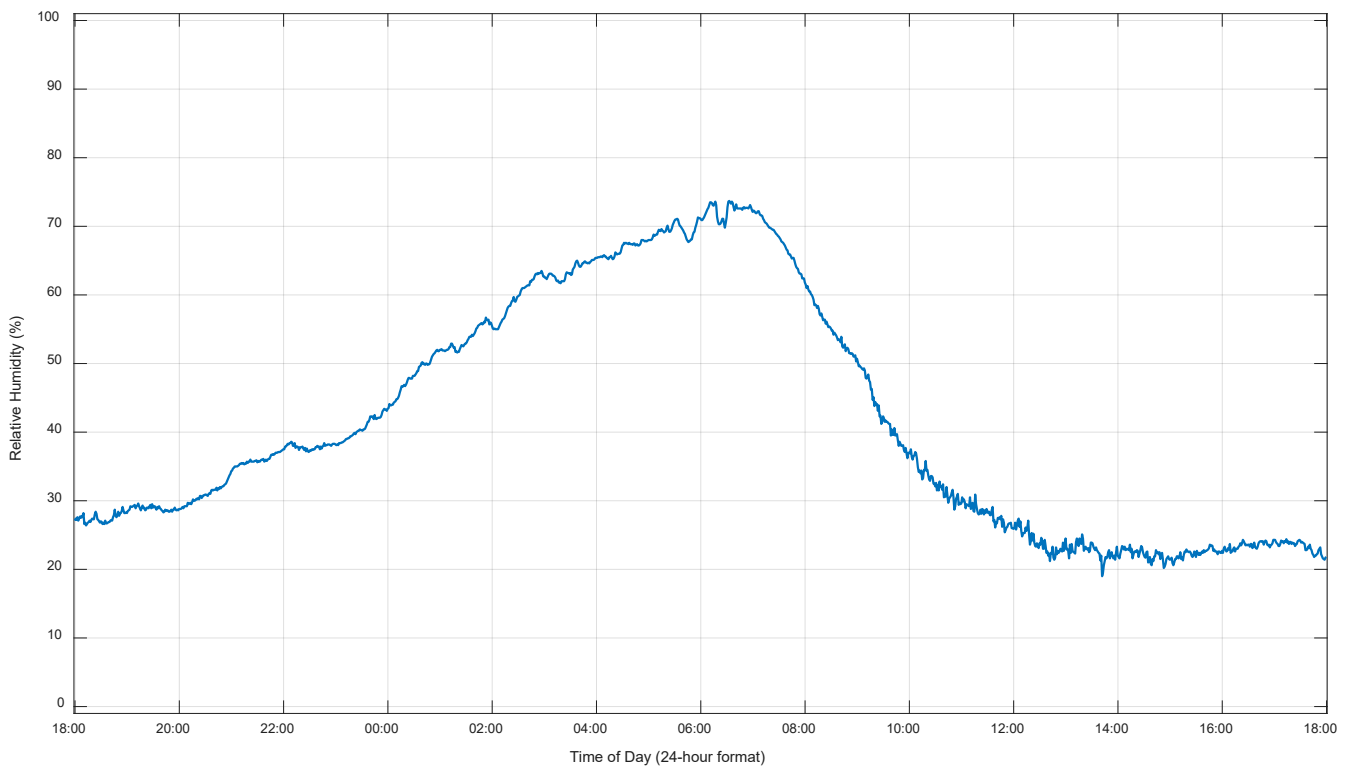

April 19 - 20, 2021 – Monitored Relative Humidity

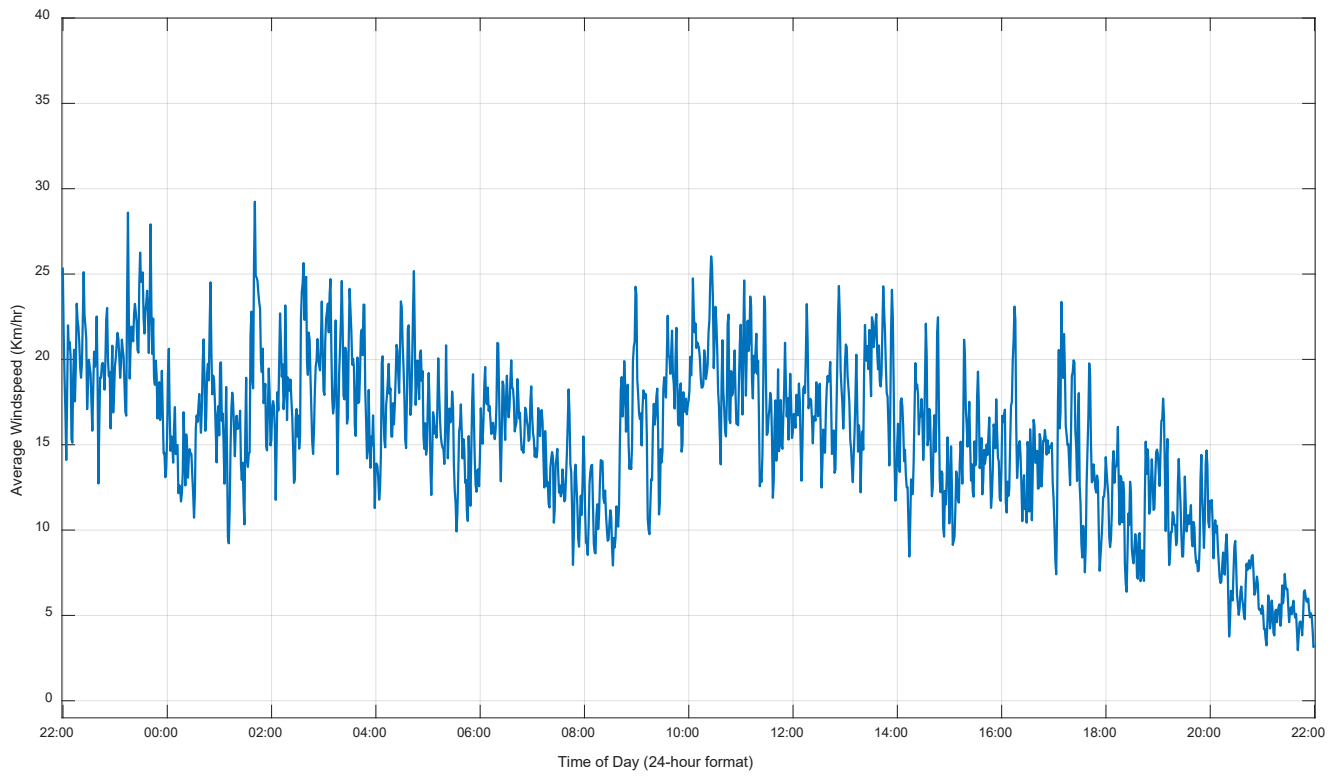

April 21 - 22, 2021 – Monitored Wind Speed

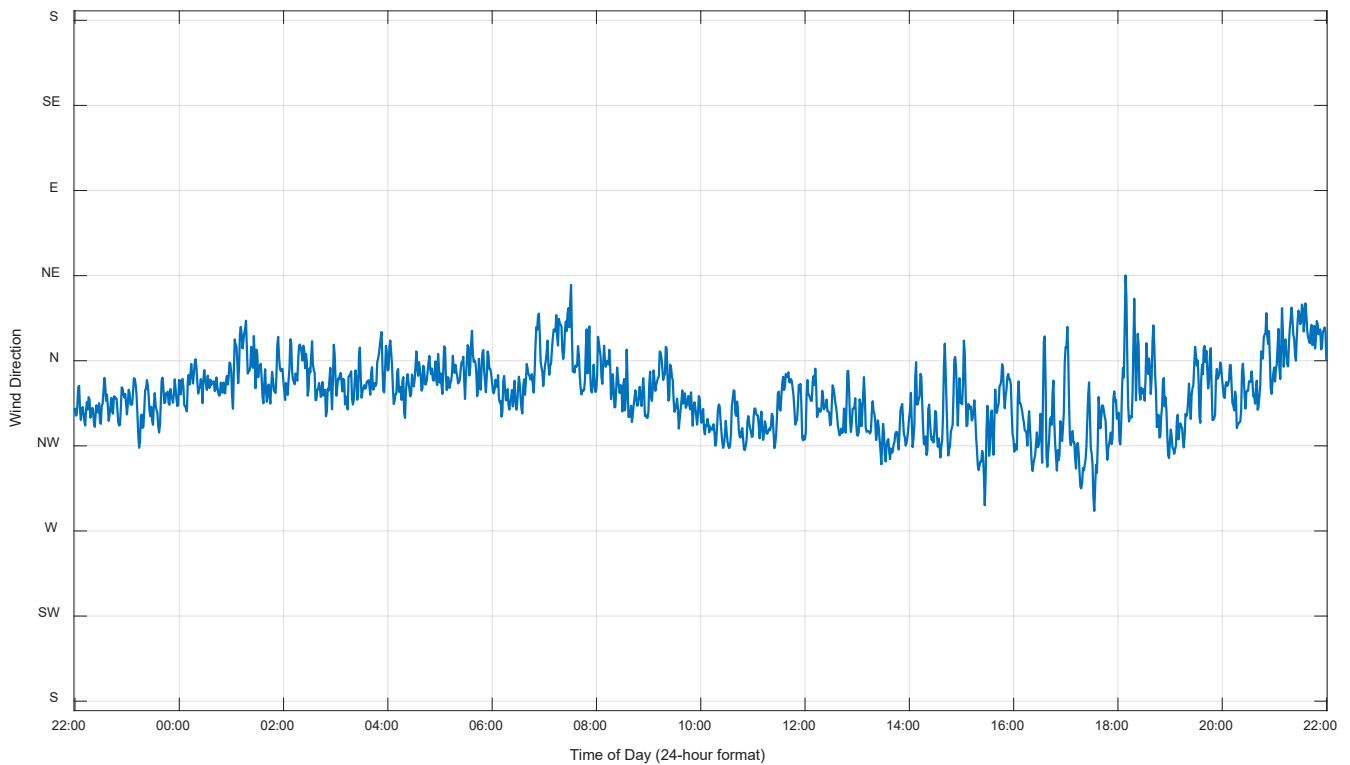

April 21 - 22, 2021 – Monitored Wind Direction

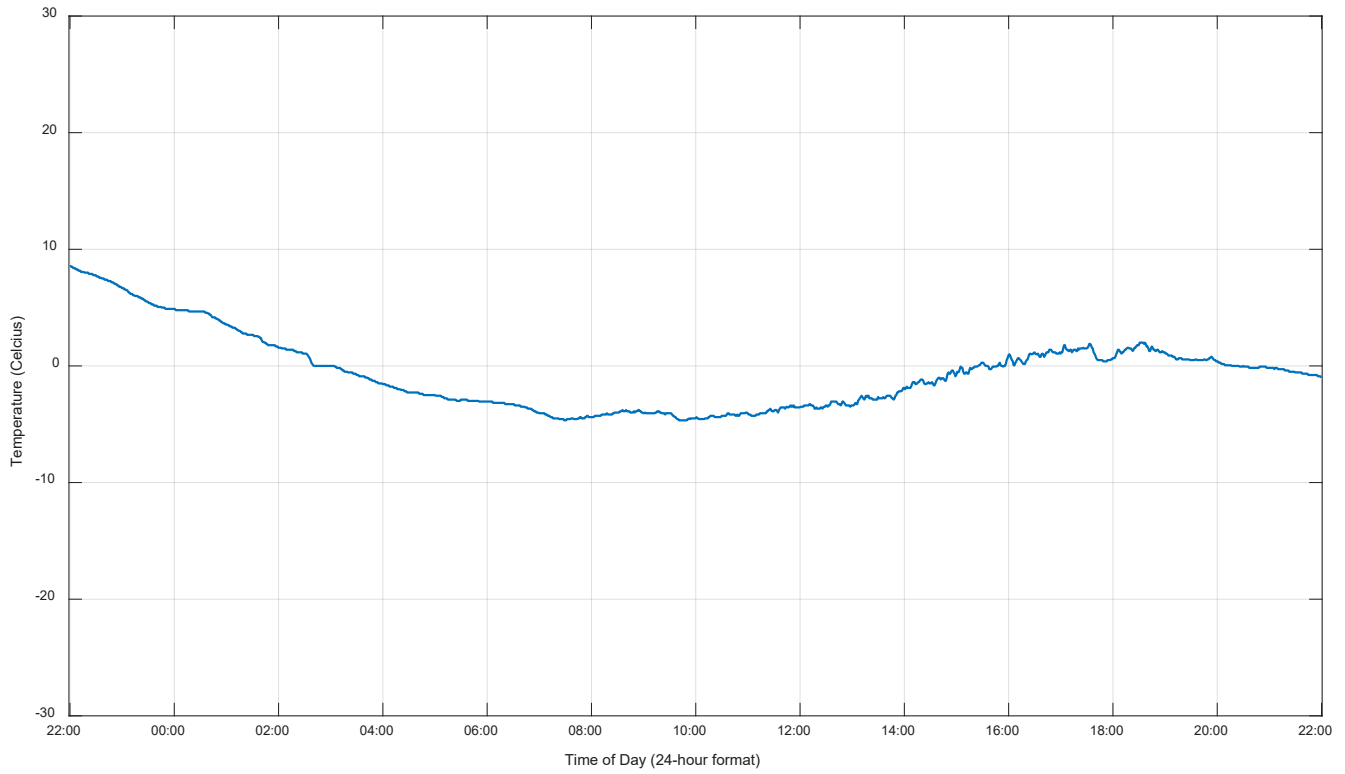

April 21 - 22, 2021 – Monitored Temperature

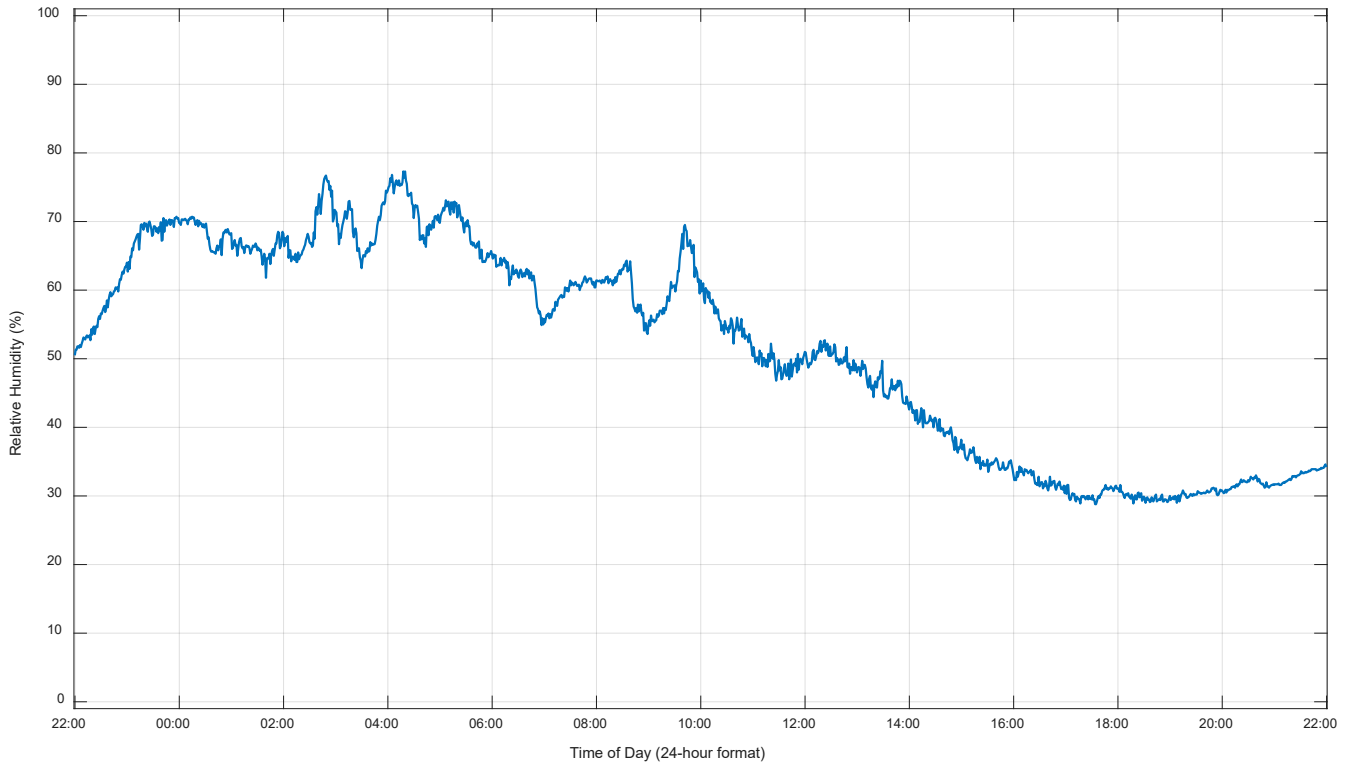

April 21 - 22, 2021 – Monitored Relative Humidity

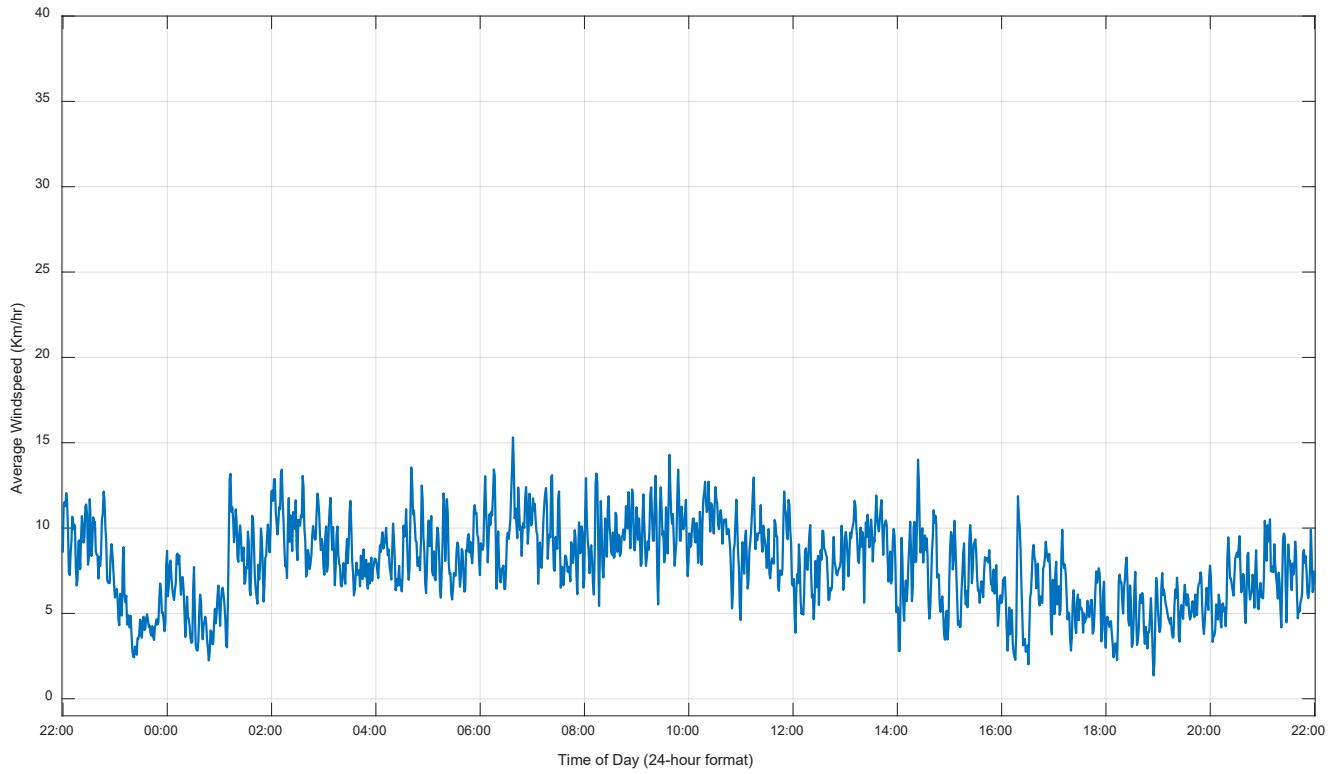

April 26 - 27, 2021 – Monitored Wind Speed

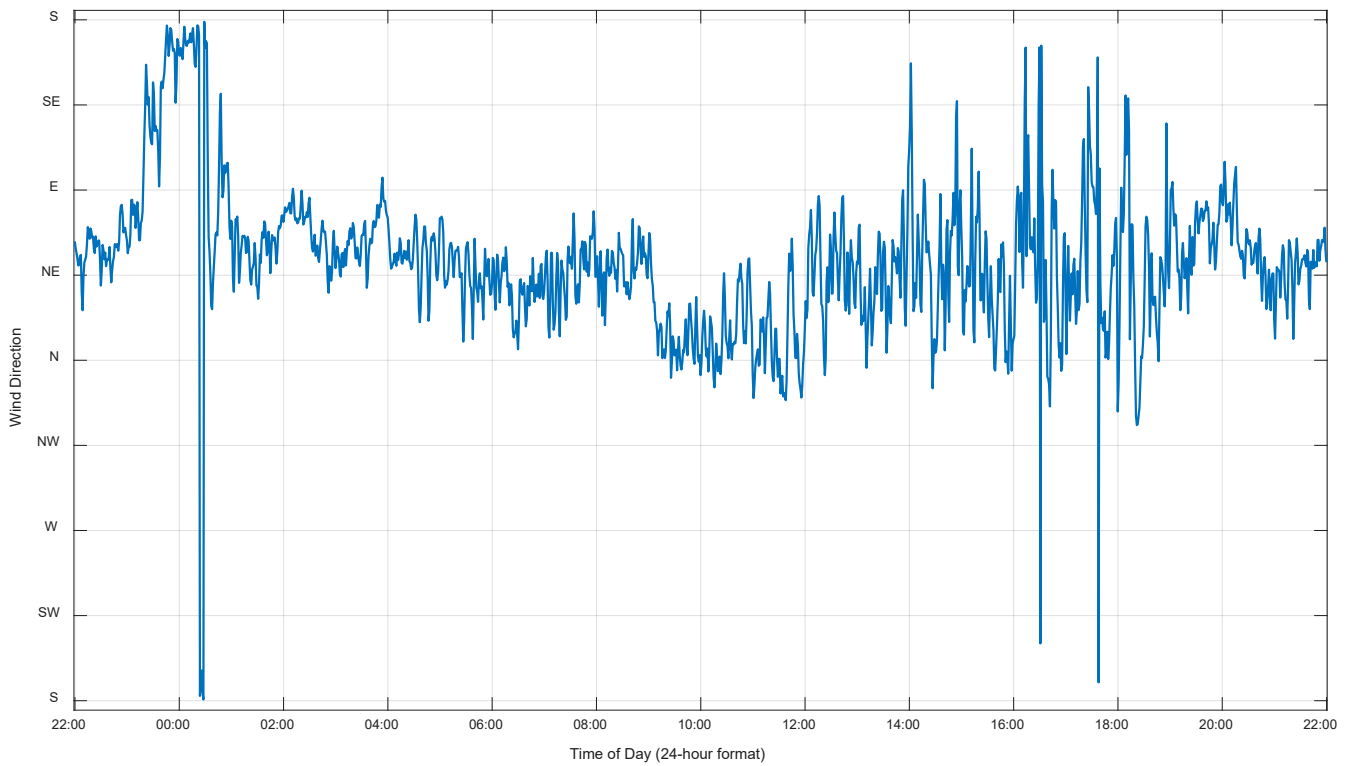

April 26 - 27, 2021 – Monitored Wind Direction

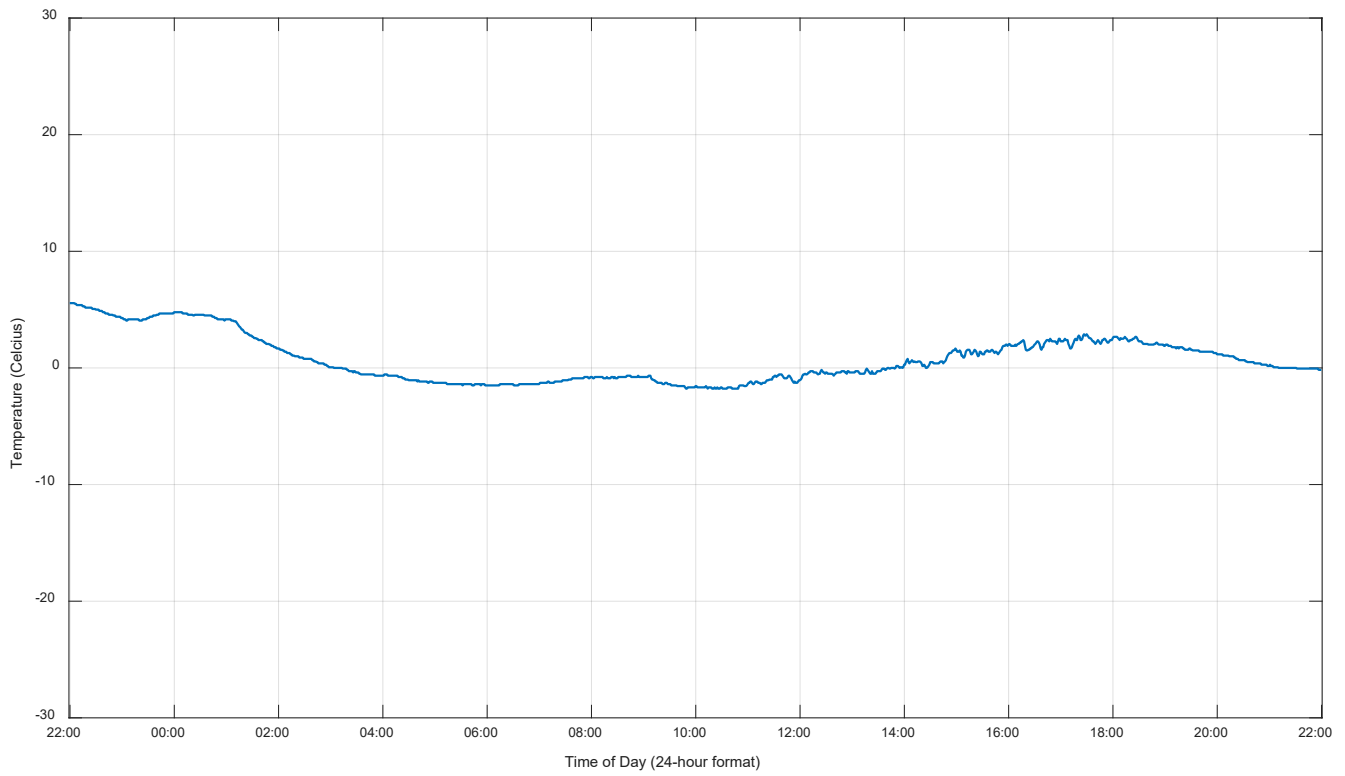

April 26 - 27, 2021 – Monitored Temperature

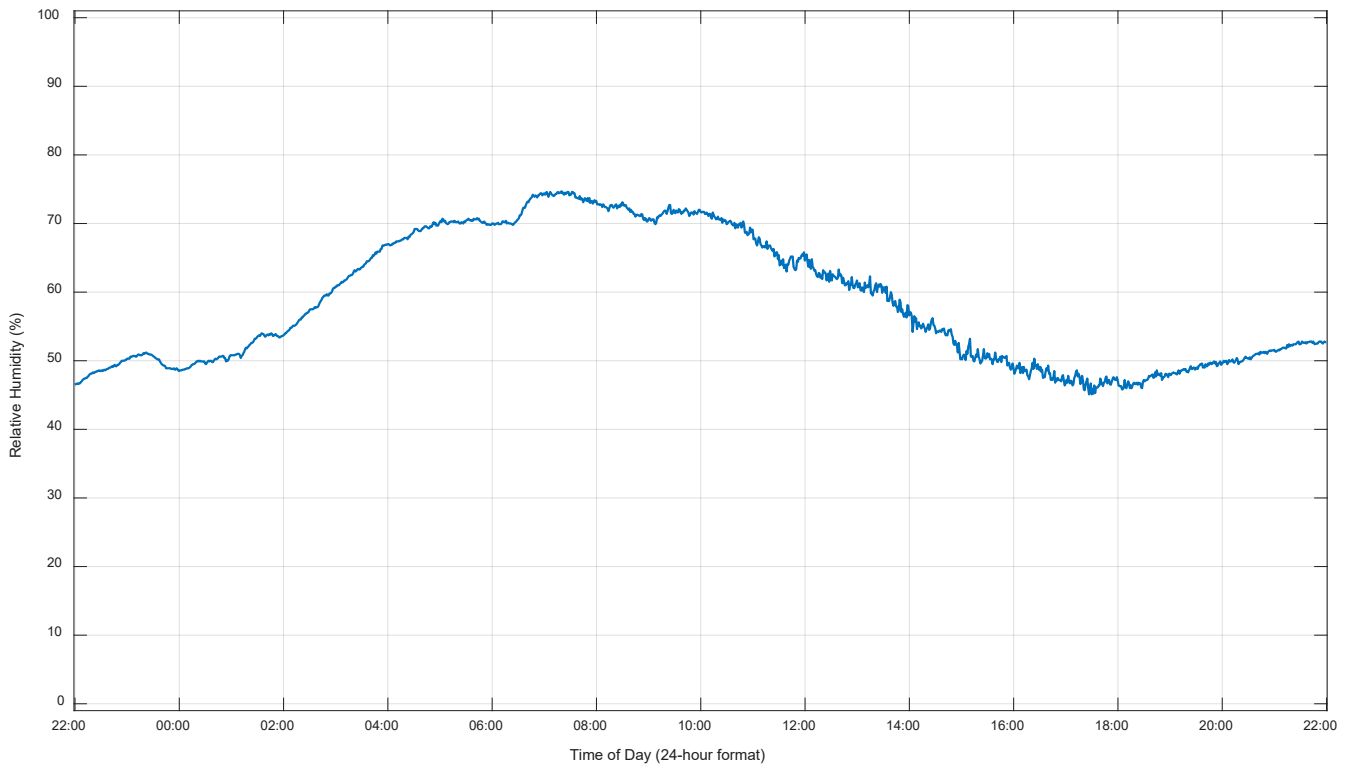

April 26 - 27, 2021 – Monitored Relative Humidity



Associated Engineering Alberta Ltd.

500, 9888 Jasper Avenue
Edmonton, AB, Canada, T5J 5C6

TEL: 780.451.7666
FAX: 780.454.7698
www.ae.ca

January 13, 2022
File: 2021-3981

Kyle Payne

City Planning
City of Edmonton
7th Floor, 10111 - 104 Avenue NW
Edmonton, AB T5J 0J4

Re: TERWILLEGAR DRIVE STAGE 2 UPGRADES ENVIRONMENTAL IMPACT ASSESSMENT

Dear Mr. Payne:

We have prepared this letter to address the City's request for additional information associated with the Terwillegar Drive Stage 2 Upgrades Environmental Impact Assessment (EIA) report (Reference Number: 401327043-001).

Please see the attached table for a summary of Associated Engineering Ltd.'s responses to the City's comments regarding the EIA report. Note that responses have not been provided for general comments and conditions; however, this information has been provided to the project management team for incorporation into planning, design, and constructions of the project, as applicable.

If you have further questions, please don't hesitate to contact me directly (cawthorne@ae.ca; 587-686-6574).

Yours truly,

A handwritten signature in black ink that reads 'Erin Cawthorn'.

Erin Cawthorn, BIT
Environmental Scientist

EC

**A Carbon
Neutral
Company**



Platinum
member

Table 1

Summary of City Comments and Associated Engineering Ltd.'s Responses to the Terwillegar Drive Stage 2 EIA Report

City Reviewer	City Comment	Associated Engineering Ltd.'s Response
Urban Growth and Open Space Strategy	It appears that the EIA report provided an extended area required for tree removal over the multiple locations including bridge rehabilitation as well as expansion of road right of way along the road intersections. However, the detailed offsetting plan to compensate the impact through restoration and revegetation plan was not available. EIA should identify such a plan as a part of the reporting that should clearly show the extent of tree removal and project plan to offset those impacts be incorporated within the project plan	A landscaping / restoration plan for the project is being developed. This plan will be included as part of the 60% detailed design submission to the City and will be circulated to Urban Growth and Open Space Strategy. Preliminary details of the plan have been added to Sections 4.4 and 6.2 of the EIA report. Note that the grading limits and extent of vegetation impacts are subject to change through detailed design and the landscaping / restoration plan will be updated accordingly in an iterative process that is synchronized with the progression of design.
Urban Growth and Open Space Strategy	It was understood that the project scoping determined this project will require a Site Location Study for review and approval. There was no SLS attached with this circulation so please inform the project team regarding the requirements as we should not be able to proceed with this EIA without an SLS report.	The SLS report can be found as Appendix I in the EIA report.
Urban Forestry	Alternative design options are supported to reduce the amount of vegetation removal that is being proposed. Please consider any design and construction methodologies that may help in reducing the amount of vegetation to be removed.	The use of retaining walls has been considered and implemented in project designs to reduce the amount of vegetation removal required. Additionally, this information will be provided to the project management team for incorporation into further project planning, design, and construction.
Urban Forestry	Restoration plans will be required for this project. Section 4.4 states that replacement will be of an	At a minimum, the equivalent asset value of vegetation will be replaced. Calculation of the asset

City Reviewer	City Comment	Associated Engineering Ltd.'s Response
	<p>equivalent value, however the project should increase this and aim to be above and beyond equal replacement.</p>	<p>value of vegetation to be removed includes a 2 m root zone perimeter and all asset values will be rounded up. Tree compensation for the project plans to use a compensation value of approximately \$1,000.00 per tree.</p>
<p>Urban Forestry</p>	<p>A tree preservation plan will be required for this project. This should be separated into two sections: one for natural/naturalized vegetated areas and one for inventoried ornamental trees. The tree preservation plan should also include a full tree removal plan, including an overhead aerial map of the removal section as well as indicate the area (m2,ha etc.) to be removed. The tree preservation plan should be reviewed and approved by Urban Forestry and Natural Area Operations.</p>	<p>Noted, thank you. A tree preservation plan will be completed for this project and it will be circulated to Urban Forestry and Natural Area Operations for review and approval.</p>
<p>Urban Forestry</p>	<p>Public engagement is a key requirement of live tree removal; please ensure this is being completed as early as possible in all forms of engagement sessions and that the tree removal plan is clearly defined and outlined for the public to understand, during the engagement phase(s). There will be a requirement for additional notices to be distributed as well prior to the removal of trees.</p>	<p>Tree removal and tree replacement information will be shared with the public in multiple formats including website updates, E-newsletter, pre-construction bulletins, and public engagement open houses.</p>
<p>EPCOR Drainage</p>	<p>Has EPCOR Drainage been consulted on new tie-ins to the system and increased flows into the system?</p>	<p>Yes, EPCOR Drainage has been consulted, and the project team is working with them to accommodate their requirements for connection to the existing system and the increased flows. EPCOR Drainage</p>

City Reviewer	City Comment	Associated Engineering Ltd.'s Response
Parks and Road Services (Natural Areas Operation)	The project should aim to minimize vegetation removal wherever possible. The project disturbance areas are within highly sensitive natural areas and planted naturalization areas that promote an ecological corridor. Restoration of this ecological corridor will take time as the vegetation matures, therefore it is imperative to minimize removal of mature trees.	will have opportunity to review and comment on future design submissions to the City. Noted, thank you. This information will be provided to the project management team for incorporation into project planning, design, and construction.
Parks and Road Services (Natural Areas Operation)	Landscape/restoration plans must be circulated and reviewed by Natural Area Operations prior to approval. It is recommended that bioengineering be used along any slopes.	A landscaping / restoration plan for the project is being developed. This plan will be included as part of the 60% detailed design submission to the City and will be circulated to Natural Areas Operation. Preliminary details of the plan have been added to Sections 4.4 and 6.2 of the EIA report.
Parks and Road Services (Natural Areas Operation)	The project should not develop/limit their restoration plans based on the replacement costs of the tree asset value. Instead, the project should develop these plans with the intent to restore these areas based on a reference habitat. This may include planting more densely and planting more than the replacement costs.	Noted, thank you. The landscaping / restoration plan is accounting for the high value ecological areas identified in this EIA report. Additionally, this information will be provided to the project management team for further consideration in development of the landscaping / restoration plan.
Parks and Road Services (Natural Areas Operation)	Please note that a Tree Preservation Plan will be required for the natural stands and stand-alone trees, which must also include a detailed removal plan. A Tree Permit will be needed as per the approved Public Tree Bylaw 18825.	Noted, thank you. A Tree Preservation Plan will be developed for the project and a Tree Permit will be obtained as per Public Tree Bylaw 18825.

City Reviewer	City Comment	Associated Engineering Ltd.'s Response
Parks and Road Services (Natural Areas Operation)	There is a high density of regulated weeds along the naturalized areas. The project should consider developing weed specific management plans to minimize spread and ensure any restoration does not end up being dominated by weeds.	Noted, thank you. This information will be provided to the project management team for consideration into tender requirements for the project-specific Environmental Construction Operation Plan.
Parks and Road Services (Natural Areas Operation)	As per the Live Tree Removal Guidelines, public engagement and notification will be required prior to any vegetation removals.	Noted, thank you. Public engagement and notification requirements of the Live Tree Removal Guidelines will be followed.
Parks and Road Services (Resource Planning and Land Development)	A detailed, scale landscape design for the project must be provided for review and approval by Open Space Operations including Natural Areas Operations and Urban Forestry.	A landscaping / restoration plan for the project is being developed. This plan will be included as part of the 60% detailed design submission to the City and will be circulated to Open Space Operations including Natural Areas Operations and Urban Forestry. Preliminary details of the plan have been added to Sections 4.4 and 6.2 of the EIA report.
Parks and Road Services (Resource Planning and Land Development)	Please follow the Design and Construction Standards Volume 5 Landscaping (2021) when designing any new landscaping or landscaping restoration for this project in all affected areas.	Noted, thank you. The landscaping / restoration plan for the project will follow the Design and Construction Standards Volume 5 Landscaping (2021).
Parks and Road Services (Resource Planning and Land Development)	Please ensure that any design incorporates a low maintenance approach. Please incorporate naturalized plantings in lieu of mass ornamental planting in all landscaped areas. Naturalization is supported by the City of Edmonton as a means to provide more sustainable landscapes, to enhance biodiversity, and to	Noted, thank you. The landscaping / restoration plan is accounting for the high value ecological areas identified in this EIA report. This information will be provided to the project management team for further consideration in development of the landscaping / restoration plan.

City Reviewer	City Comment	Associated Engineering Ltd.'s Response
	provide educational opportunities. We encourage naturalized planting that meets construction standards and that is sustainable. Note: Please consider our current service levels when designing all landscaping.	



Memo To: Kyle Payne

January 24, 2022

- 1 -

Date:	January 24, 2022	File:	2021-3981
To:	Kyle Payne	Page:	Page 1 of 7
From:	Erin Cawthorn, BIT		
Project:	Terwillegar Drive Stage 2 Upgrades		
Subject:	Additional Drainage Infrastructure		

Associated Environmental Consultants Inc. (Associated) has prepared this memo to support the Terwillegar Drive Stage 2 Environmental Impact Assessment (EIA) report previously submitted to the City of Edmonton for review. New drainage infrastructure has been added to the project since the previous EIA submission on January 13, 2022. Based on a discussion between Associated, CIMA+, and the City of Edmonton it was agreed that a memo would be sufficient to provide supplemental information regarding the newly proposed drainage infrastructure for environmental review. As such, this memo is supplemental to the EIA report and provides an assessment of the potential environmental impacts and mitigations associated with the new drainage infrastructure.

1 ADDITIONAL FOOTPRINT

The new drainage infrastructure consists of two storm water management facilities that will manage the altered surface water drainage patterns associated with this project. One storm water management facility is planned for development south of the laydown/parking area within Whitemud Park ([Appendix A](#)). The second storm water management facility is planned beneath the existing overflow gravel parking lot to the north of the west bound bridge. Currently the storm water management facilities are in preliminary design with limited details; however, initial design options recommend underground structures to prevent the loss of land use and visual impacts. Design of the storm water management facilities will maintain the same discharge rate into Whitemud Creek that is currently present.

2 ENVIRONMENTAL SENSITIVITIES

Generally, the environmental sensitivities examined as part of the EIA are applicable to the newly planned storm water management facility and its additional footprint; however, previous site visits did not include this area. Environmental sensitivities that have the potential to be impacted by the storm water management facility are listed below. For additional details surrounding these environmental sensitivities see Section 3 of the EIA.

- Groundwater
 - Groundwater level is anticipated to occur at approximately 4 m below ground surface.
- Soils and Terrain
 - Presence of native and/or anthropogenic topsoil and subsoil.
 - Proximity to banks of unnamed watercourse that is a tributary to Whitemud Creek with moderate to steep slopes.
- Surface Water
 - Proximity to unnamed watercourse that is a tributary to Whitemud Creek, which is located within 50 m downstream of the planned storm water management facility. Potential surface water bodies (e.g. wetlands) in the riparian area of the unnamed watercourse.

Memo To: Kyle Payne

January 24, 2022

- 2 -

- Vegetation
 - Primarily open vegetation dominated by herbaceous plant species with the occurrence of patches of trees and shrubs.
- Wildlife
 - Presence of habitat with the potential support wildlife features such as bird nests, mammal dens/burrows, hibernacula, and amphibian breeding sites.
- Historical Resources
 - Lands with a historic resource value of 5 for archaeology and palaeontology.

3 IMPACTS AND MITIGATION MEASURES

Potential environmental impacts identified in the EIA report are applicable to the planned storm water management facility. The mitigation measures developed to address these potential environmental impacts remain applicable. Regulatory permitting requirements need to be reviewed and updated, as applicable.

Details regarding potential environmental impacts resulting from the addition of the storm water management facility are presented in [Table 1](#). Specific mitigation measures to address these new potential environmental impacts are presented in [Table 2](#).

Table 1. Potential Environmental Impacts of Storm Water Management Facility

Ecosystem Component	Direction and Description of Impact	Characteristic of Impact Before Mitigation Measures
Surface Water – Water quality in adjacent surface water bodies	Negative – Sedimentation of adjacent surface water bodies from erosion of bare soil during construction.	Nature: Indirect Magnitude: Moderate Spatial Extent: Local Duration: Short-term Likelihood: High
Surface Water and Fish Habitat – Adjacent surface water bodies	Negative – Contamination of adjacent surface water bodies from materials used during the construction.	Nature: Indirect Magnitude: Moderate Spatial Extent: Local Duration: Long-term Likelihood: Moderate
Fish – Fish inhabiting adjacent surface water bodies	Negative – Increased sedimentation of fish habitat from sediment-laden runoff.	Nature: Indirect Magnitude: Moderate Spatial Extent: Local Duration: Short-term Likelihood: Moderate
Fish – Fish inhabiting adjacent surface water bodies	Negative – Sensory disturbance to fish from construction lighting and noise.	Nature: Direct Magnitude: Low Spatial Extent: Local Duration: Short-term



Memo To: Kyle Payne

January 24, 2022

- 3 -

		Likelihood: Moderate
Terrain and Soils – Stability of slopes associated with adjacent unnamed watercourse valley	Negative – Alteration of surface and subsurface conditions potentially leading to slope instability.	Nature: Indirect Magnitude: Moderate Spatial Extent: Local Duration: Long-term Likelihood: Moderate
Wildlife – Wildlife features in the banks of the unnamed watercourse such as hibernacula and/or mammal dens	Negative – Disturbance or destruction of active wildlife features.	Nature: Direct Magnitude: High Spatial Extent: Local Duration: Long-term Likelihood: Moderate

Table 2. Mitigation Measures to Address Environmental Impacts of the Drainage Infrastructure

Ecosystem Component	Environmental Impact	Mitigation Measures for Planning and Design Phase	Mandatory Mitigation Measures for Construction Phase
Surface Water – Water quality in adjacent surface water bodies	Sedimentation of adjacent surface water bodies from erosion of bare soil during construction.	<ul style="list-style-type: none"> • Include additional footprint in restoration plan. • Incorporate permanent ESC measures into design of the planned storm water management facility. 	<ul style="list-style-type: none"> • Minimize the extent and duration of soil exposure, especially during periods when the ground is not frozen. • Include an ESC Plan in the project-specific ECO Plan. • Install and maintain appropriate ESC measures throughout construction with attention to the adjacent surface water bodies as important environmental sensitivities.
Surface Water and Fish Habitat – Adjacent surface water bodies	Contamination of adjacent surface water bodies from materials used during the construction.	<ul style="list-style-type: none"> • Require the contractor to develop and implement an ESC Plan as per the City of Edmonton Erosion and Sedimentation Control Guidelines (2005). 	<ul style="list-style-type: none"> • Include material storage and handling practices in the project-specific ECO Plan with awareness that adjacent surface water bodies are an important environmental sensitivity. • Avoid use of hazardous substances near to adjacent surface water bodies. • Avoid refuelling or equipment repairs or maintenance near to adjacent surface water bodies. • Use double-containment for hazardous material storage. • Install drip trays beneath stationary equipment. • Perform routine inspection of equipment and construction area to ensure equipment is in good working condition and hazardous materials are contained and stored adequately. • Prepare a Spill Response Plan. Ensure all crew members and sub-consultants have reviewed the plan and are trained in the use of spill prevention and clean-up materials and procedures.

Fish – Fish inhabiting adjacent surface water bodies	Increased sedimentation of fish habitat from sediment-laden runoff.	<ul style="list-style-type: none"> • Include adjacent surface water bodies in recommendations developed by a Qualified Aquatic Environment Specialist. • Require the contractor to develop and implement an ESC Plan as per the City of Edmonton Erosion and Sedimentation Control Guidelines. 	<ul style="list-style-type: none"> • Dewater sediment-laden water within isolated areas to a well vegetated area to promote sediment filtration prior to re-entry to water bodies. Other methods of sediment filtration (e.g., silt bag) may also be suitable to prevent the release of sediment-laden water.
Terrain and Soils – Stability of slopes associated with adjacent unnamed watercourse valley	Alteration of surface and subsurface conditions potentially leading to slope instability.	<ul style="list-style-type: none"> • Complete a geotechnical assessment to support the design of the storm water management facility. Incorporate recommendations of geotechnical professionals into designs, as applicable. 	<ul style="list-style-type: none"> • Adhere to relevant recommendations of geotechnical professionals.
Wildlife – Wildlife features in the banks of the unnamed watercourse such as hibernacula and/or mammal dens	Disturbance or destruction of active wildlife features.	<ul style="list-style-type: none"> • Retain qualified environmental professional to complete survey for potential wildlife features in the spring of 2022 to inform design and construction. 	<ul style="list-style-type: none"> • Adhere to recommendations and/or mitigations of qualified environmental professional regarding potential wildlife features. • If wildlife features are encountered during construction stop work and inform project manager.



Memo To: Kyle Payne

January 24, 2022

- 6 -

4 CLOSURE

This memo was prepared to provide supplemental information on the storm water management facility to be developed as a part of the Terwillegar Drive Stage 2 Upgrades project. Information regarding the storm water management facility was made available following the submission of the EIA report to the City Planning Department.

If you have any questions, please feel free to contact the undersigned at 587-686-6574 or cawthorne@ae.ca.

Prepared by:

A handwritten signature in blue ink, appearing to read 'Erin Cawthorn'.

Erin Cawthorn, BIT
Environmental Scientist

EC

Reviewed by:

A handwritten signature in blue ink, appearing to read 'Brett Bodeux'.

Brett Bodeux, M.Sc., P.Biol., AIT
Environmental Scientist

BB



Memo To: Kyle Payne

January 24, 2022

- 7 -

APPENDIX A - FIGURE 1-1

