

2

FOUNDATIONAL ELEMENTS

City of Edmonton

VISUAL IDENTITY STANDARDS

Edition 1.4, May 2025, © City of Edmonton



PURPOSE OF THIS GUIDE

Building on our Corporate Brand Guidelines, this is guide two in our series.

A cohesive design language reflects and elevates an organization's brand. Together with the City logo, our visual identity allows corporate messages, collateral and other business assets to be clearly recognizable to our audiences. With this, we create consistency, strengthen our connections and enhance the reputation of the work we do.

Visual Identity Standards: Foundational Elements dives deeper into the components of our visual identity system and explores how its style can be applied.

This document is specifically intended to support designers and creative professionals in expressing the City's brand consistently, creatively and effectively. It can also help business areas and communications advisors understand their role in being stewards of our brand.

For more information please visit edmonton.ca/visualidentity or contact brandteam@edmonton.ca.

CONTENTS

1 INTRODUCTION	7 IMAGERY
04 Guiding Principles	30 Photography
05 Beginning with Brand	31 Selection
06 Our Brand Platform	32 Cropping
	33 Video
2 LOGO	36 Icons
07 Logo: Past and Future	37 Illustration
08 Primary	
09 Primary, Secondary + Wordmark	8 PLACEMENT + GRID
10 Clear Space: Primary	43 Composition: The Grid System
11 Clear Space: Wordmark	45 Primary Logo Staging
12 Minimum Size	46 Arrangement
13 Logo Misuse	
14 Placement with Partner Logos	9 APPLICATIONS AND USAGE
	47 Staff Uniforms
3 APPROACH TO DESIGN	48 Promotional Items
15 Brand Architecture	49 Nomenclature
16 Accessibility Requirements	50 Glossary
	51 Find Assets
4 COLOUR	52 Contact
17 Palette	
18 Primary Colours	
19 Complement Colours	
20 CMYK, RGB and HEX values	
5 TYPOGRAPHY	
21 Application of Typography	
22 Primary Typefaces	
26 System Typefaces	
27 Google Typefaces	
28 Setting Type Basics	

GUIDING PRINCIPLES

These core principles should always guide the way we express and deliver our brand.

ACCESSIBILITY

We're moving away from providing a 'one-size fits all' citizen experience and actively consider Edmontonians of all backgrounds, ages and abilities. From our facilities and transportation to our communication and technology, we commit to ensuring all people have equitable access and opportunity to participate to the fullest extent in our city.

CITIZEN-CENTRIC THINKING

We prioritize the needs of the people we serve instead of our internal requirements and processes. Our programs and services meet the needs of Edmontonians and the information we provide is easy for them to access and understand.

GENDER-BASED ANALYSIS PLUS (GBA+)

GBA+ is a tool which helps us examine how intersecting identity factors (like sex, gender and ethnicity) can produce inequalities and privileges for certain individuals and groups. By challenging our assumptions and identifying missing perspectives, we can be more inclusive in our approach to developing, delivering and evaluating programs and services.

INCLUSION

At the City, inclusion means we:

- intentionally seek and value diversity
- implement systems and practices that
- advance equity and respect
- develop skills at working inclusively
- adopt best practices in diversity and inclusion

We identify some ways to apply these principles throughout this document but we encourage you to actively consider other ways to strengthen implementation in your areas.

BEGINNING WITH BRAND

Before exploring the City's visual identity standards, we need to first understand our brand.

Brand is not a logo or a tagline but a perception. It is what people think and feel about an organization, company or product. It can be negative, positive or anywhere in between. Though these impressions already exist, we have the opportunity to shape them.

THE CITY BRAND

Our corporate brand is specific to the operations of our organization – City of Edmonton, our local municipal government. Think of it as our organization's personality. It drives our culture, decisions, strategies, programs, services and interactions.

PLACE BRAND

Our corporate brand is different from Edmonton's place brand. A place brand is the perception people have of a city, based on their awareness of and experience with that city. Simply put, it answers the question [Why Edmonton.](#)

OUR BRAND PLATFORM

PROMISE

Working together, we enable a better life for Edmontonians.

No matter what work we are involved in—large city-building projects, routine public-facing operations or something in between—our promise defines what we do and what Edmontonians can expect from us. Not only does it give us focus and direction, it reinforces our commitment to this goal.

POSITIONING

We provide supportive and quality public services as we build a thriving, sustainable and welcoming home for Edmontonians of today and tomorrow.

An extension of our promise, our positioning is meant to guide our actions and establish the value we offer.

DRIVERS

- collaborative
- community-focused
- efficient
- open
- progressive

Drivers are a set of personality traits which are the defining qualities behind our work.

None of the components need to be explicitly spelled out to the public: instead, we demonstrate them through our brand expression and delivery of brand experience. They are cues to steward all of our touchpoints and build our brand.

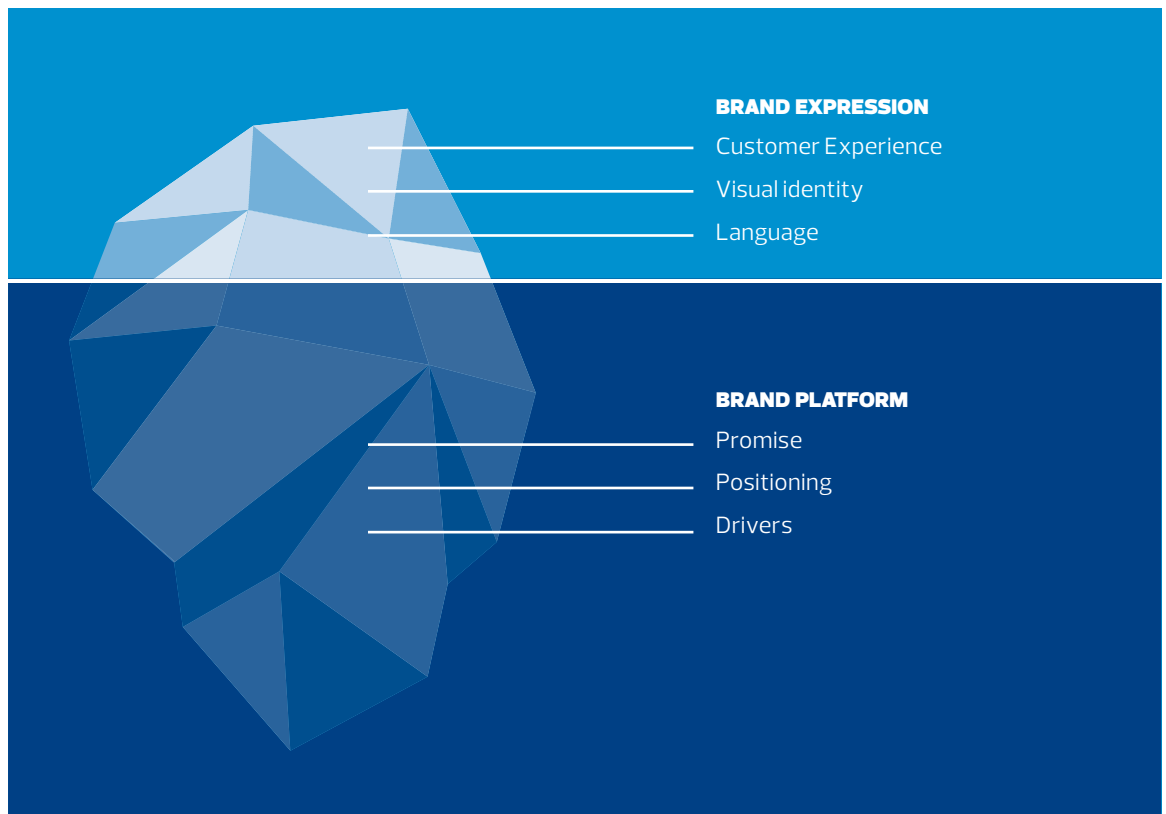

CELEBRATING THE CITY'S PAST AND FUTURE WITH HISTORY

The City logo (or signature) was developed in 1976 and adopted in 1977. Since that time, it has spread into every corner of the City's corporate identity and communications. It is now extremely well-recognized by the public and possesses considerable brand equity.

The original logo was based on a typeface popular in the 1970s: Serif Gothic Bold. The lettering was set tightly together, which reflected the typographic fashion of the period.

After several decades, the time had come to refresh our corporate look.

"The City of" has been removed from the logo. Renewed lettering is integrated into a blue square for visual emphasis. The individual letters have been streamlined and opened up to better meet the technical demands of today's multimedia platforms.

The refreshed logo is an important part of our transformational brand story. The updated design maintains a direct connection to our past success. More importantly, it reflects our ability to find new ways to build on who we are and what we do—providing supportive and quality public services as we build a thriving, sustainable and welcoming home for Edmontonians of today and tomorrow.



LOGO: PRIMARY

The logo consists of the Edmonton wordmark and the blue square, bringing together the city name and our steadfast commitment to a one–City approach.

Both elements are important to the history and future of the City's identity—moving the symbol of our past successes into a more modern frame.

To build positive brand equity, the City logo must be used consistently and correctly at all times.

Never, under any circumstances, alter or recreate the logo. Only use the approved digital files when applying the City logo.

FILE ACCESS

Files are available in the approved colours, in vector and bitmap formats, including EPS, TIFF and JPG file types.



LOGO: PRIMARY + SECONDARY

PRIMARY SQUARE LOGO

Use the primary square logo whenever possible. These logos are available in multiple variants, each with rules on application and use. The colour logo is preferred.

SECONDARY WORDMARK LOGO

The wordmark **may only be used** in applications where a lack of vertical space would reduce the primary square logo to an unreadable size or lack of presence. The wordmark is **not to be used** as an alternative to the primary square logo.

Please note that in order to use the wordmark, permission is required from brandteam@edmonton.ca.

COLOUR

This version is preferred.
PMS: 2945
CMYK: 100/64/13/2
RGB: 0/80/135
HEX: 005087



BLACK

Use this version for applications that prohibit colour. Reverse (white) may be used in situations where contrast is reduced by background colour.



REVERSE WHITE

Use the keyline version **only** on dark backgrounds, dark photography and instances where contrast is required for clarity or a more subtle City identifier is required.



CLEAR SPACE: PRIMARY

The City logo should always include a minimum distance or “clear space” from graphic elements, text and other visual identities.

The only exceptions to this rule is when allowing a reduced distance to the edge of printed and digital materials.

To ensure maximum visibility, the space requirement is defined by (X), which is equivalent to the height of the capital “E” in the logo.



CLEAR SPACE: SECONDARY WORDMARK

The wordmark should always include a minimum distance or "clear space" from graphic elements, text and other visual identities.

To ensure maximum visibility, the space requirement is defined by (X), which is equivalent to the height of the blue square in the logo.



MINIMUM SIZE

The minimum size refers to the smallest allowable reproduction size while ensuring the logo is legible and effective. There are values for both print and online applications.

When possible, scale and proportion should be determined by the available space and alignment to the layout grid.

Please note these are minimum—not preferred sizes—and should be used only when space is very limited.



LOGO IN PRINT

The minimum size for use in printed materials:
0.75" / 19mm



LOGO ONLINE

Minimum size for screen displayed at 72 PPI
height = 72 pixels or 1.0" / 25.4mm



WORDMARK PRINT & SPECIAL APPLICATIONS

The minimum size for use in reproduction including print: 1.25" / 31.8mm

MISUSE

Consistent use of the City logo is important to the recognition and value of the brand.

The following are unacceptable uses of the City logo. Please ensure that all artwork is used exactly as supplied and not altered.

All questions about usage can be directed to:
brandteam@edmonton.ca



DO NOT stretch any elements of the logo



DO NOT fade or use transparency settings



DO NOT recolour the box or wordmark



DO NOT rotate or place on an angle



DO NOT add drop shadows or effects



DO NOT fill the box with imagery or patterns*

** An exception to this rule is for social media profile images for City of Edmonton run accounts. For these, it is acceptable for the keyline white City logo to be set against a photo.*



DO NOT scale individual letters or alter wordmark



DO NOT use old Edmonton logo



DO NOT crop Edmonton logo

PLACEMENT WITH PARTNER LOGOS

There are many instances when the City logo will have to appear with other partner logos. If there is a choice in arrangement, the preferred position for the City logo is the 'anchoring' position either at the beginning or at the end of the line of logos.

The surface area (or visible volume) of the City logo should be approximately the same as the area of each of the companion logos—unless the City is the lead partner, in which case the City logo will be larger.

Partner logos should be spaced at approximately half a City logo-width from the City logo and from each other as shown.

Minimum size for the City logo appearing with partner logos is also shown below.

EQUAL SPONSORSHIP

USE OF WORDMARK

There is **NO** visible advantage to using the wordmark in applications smaller than shown here. The minimum size for the wordmark does not allow the partner logos to be reduced any smaller than shown in this example.

Do **NOT** use the wordmark for partner logo applications unless there is a height restriction. Contact brandteam@edmonton.ca for questions about logo files, usage and approvals.

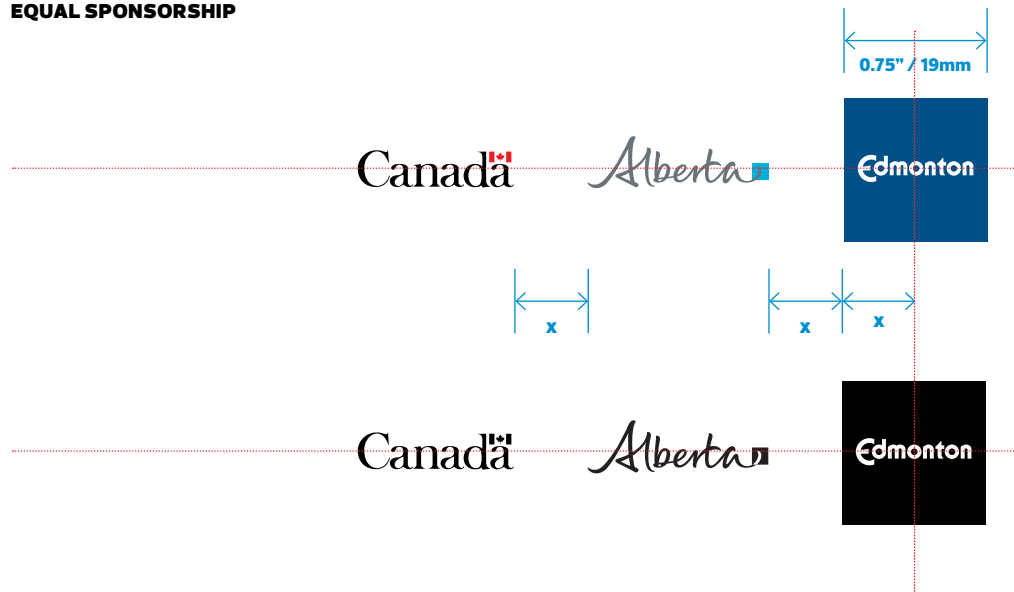

BRAND ARCHITECTURE

Brand architecture is the relationship between our primary City brand and our individual programs and services.

Historically, our approach to branding was decentralized. This meant there were many individual logos and visual identities, sometimes with little to no connection to the City of Edmonton. This approach is called a “house of brands.”

HOUSE OF BRANDS

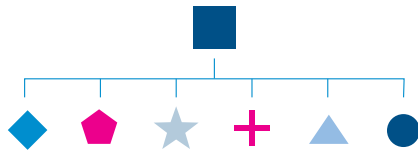

We are now moving towards what is called “branded house.” With a branded house approach, everything reflects back to and reinforces the City’s primary brand.

BRANDED HOUSE

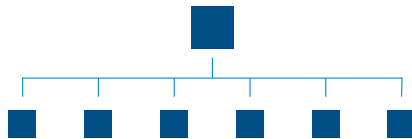

Doing this:

- creates brand recognition and equity
- reinforces our strategic priorities
- builds a connection with our audience
- demonstrates the range of services Edmontonians receive for their tax dollars

Existing independent branding efforts and logos should be phased out and aligned with with the City brand.

BEFORE



AFTER

Animal Care &
Control Centre



Municipal
Cemeteries



SECONDARY LOGOS

The square logo is the City’s primary visual identifier. The creation of any other logos to identify, represent, advertise or promote a department, branch, program, event or other City entity is prohibited without written consent from the Director, Strategic Services.

ACCESSIBILITY REQUIREMENTS

Inclusive design removes barriers, increases access and helps us connect with our audience. Please keep these accessibility practices in mind when designing for the City:

PLAIN LANGUAGE

- Use plain language and limit unfamiliar vocabulary.
- Spell out words, rather than abbreviating, shortening or using acronyms.
- Consider messaging that is easily translatable for those who use free online language translation services.

READABILITY AND DISTANCE VIEWING

When creating collateral, consider the space and your audience. Are they moving or still? If they are driving, how fast are they going? How far away are they? It's best to convey a short message that can be read between eight to 10 seconds. Limit the amount of text (~ 20 words is ideal). Ensure the font size is large enough so important information is not lost.

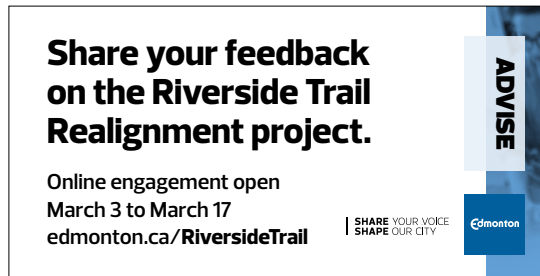

ALTERNATIVE (ALT) TEXT

- The main function of alt text is to describe an image to those who can't see it (for example, someone with a vision impairment using a screen reader). It can also be helpful for search engine optimization.
- Alt text should be a concise, objective and specific description of the image. Avoid saying "image of" or "picture of."

CLOSED CAPTIONING

- All videos should have a form of closed-captioning.
- This can include a separate .srt file (raw closed caption file) for YouTube and Facebook where closed-captioning can be turned on or off by the user, or burned-in text (text that appears within the video) for videos that are uploaded to Twitter or Instagram.

COLOUR CONTRAST

- Ensure there is sufficient contrast between background colours and foreground text.
- Designs should be in compliance with the Web Content Accessibility Guidelines AA benchmark.



COLOUR

The City of Edmonton colour palette includes primary and secondary colours. Primary colours are used for reproduction of the City logo. Secondary colours are used to express the our brand.

EXACT COLOUR MATCHING

Using exact colours is very important to the integrity of the brand. Consistency and predictability helps convey trust and confidence associated with the logo.

Please use the values included in this guide for all reproduction of the City logo and communication of City services and programs.

The PANTONE® Matching System (PMS) is the preferred colour match system. Additional ink and colour systems may not have equivalent values; therefore, approval of their use may be required.

USING MORE THAN ONE COLOUR

The expansive secondary colour palette helps communicate messages, programs and services in a cohesive manner while tailoring aesthetic to the content. Always consider how many colours you use in your design. Moderation and selection of hues is important.

Please reference the most current edition of the PANTONE® formula guide for additional standards.

Colours shown in the following pages are not intended to match the PANTONE® colour standards. Please use actual PANTONE® books or chips for colour matching.

PRIMARY COLOURS

There are three main variants of blue used by the City and the primary colour for the logo is PANTONE® 2945.

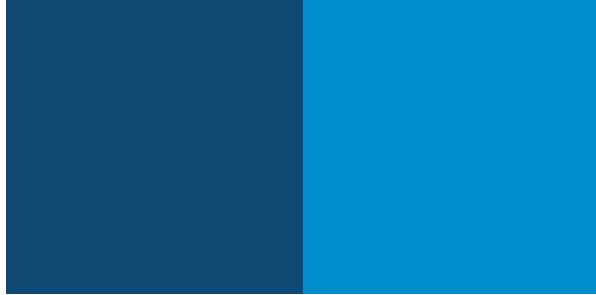

PMS 2945

CMYK 100/64/13/2

RGB 0/80/135

HEX 005087

PMS 2955

CMYK 100/74/28/17

RGB 26/58/91

HEX 193A5A

PMS Process Blue

CMYK 100/25/4/0

RGB 0/129/188

HEX 0081BC

COMPLEMENT COLOURS

The full spectrum of complement colours consists of (64) hues.

Adobe Swatch Exchange files (.ase) are available for both CMYK and RGB colour models as well as PANTONE® Solid Colours for coated (C) paper.

Use the spectrum of complement colours on both internal and external visual applications. The colours may be used singularly or in combinations for messaging backgrounds, graphic elements, charts and graphs, and typography. Colour themes should be selected to either combine or emphasize moods.

*Overlays of 90% are allowed. Tints may not be used.

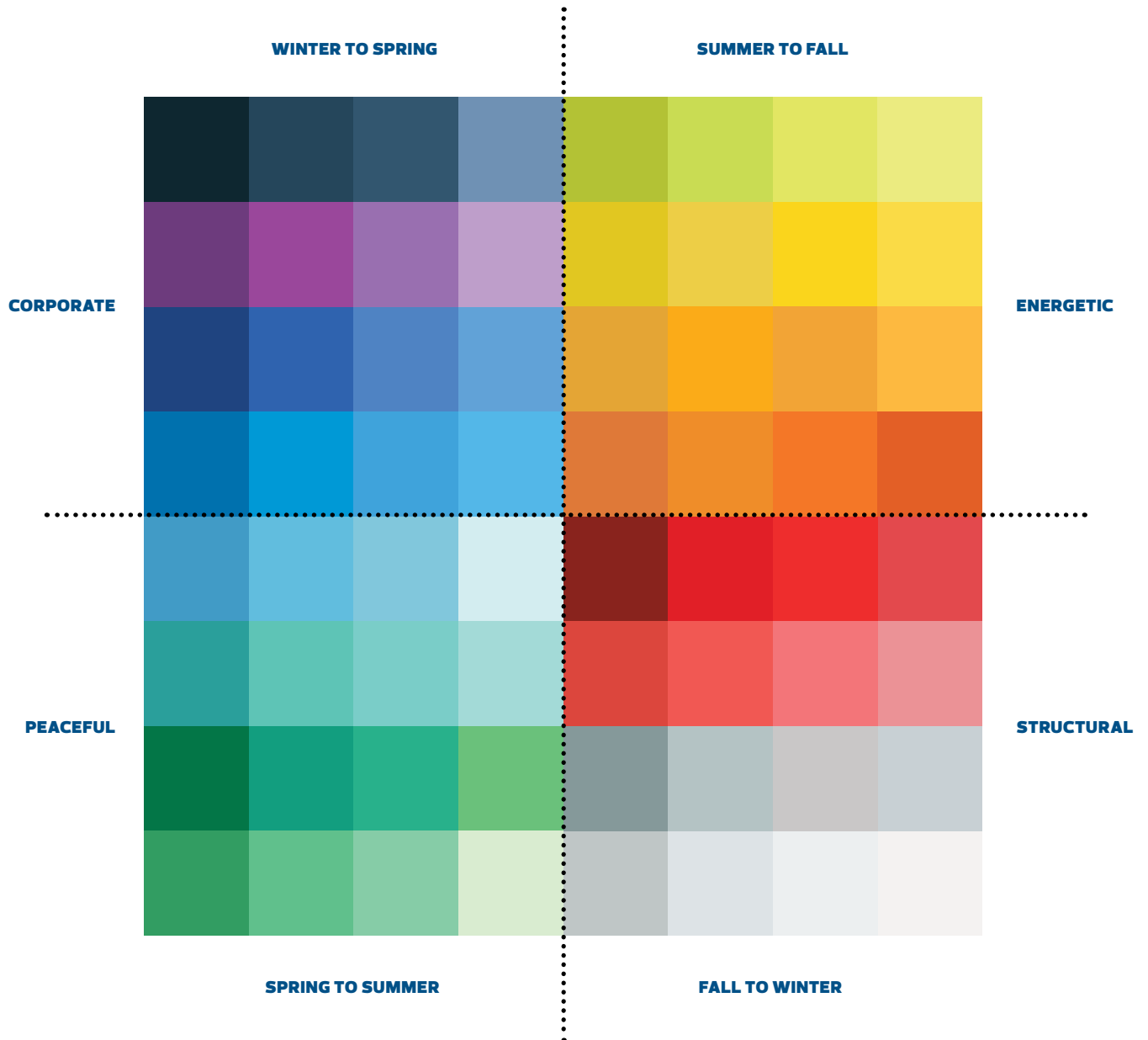

COMPLEMENT COLOUR VALUES

							
0/96/92/0 237/45/44 ED2D2C	0/81/66/0 240/88/83 F05853	30/96/100/30 137/35/29 89231D	10/88/82/0 219/69/61 DB463D	7/77/100/0 226/95/38 E25F26	10/63/89/0 223/121/56 DF7938	0/66/96/0 243/119/39 F37727	3/53/96/0 238/140/40 EE8C28
							
3/40/90/0 241/163/53 F1A334	0/30/85/0 252/185/64 FCB940	10/37/92/0 228/165/53 E4A535	0/37/100/0 250/171/24 F8AA1A	8/15/85/0 235/205/69 EDCD45	3/10/84/0 250/219/69 F9DA45	3/13/96/0 249/212/27 F9D41B	14/16/100/0 225/199/33 E1C721
							
10/0/63/0 234/234/128 EAE80	14/0/76/0 226/229/98 E2E562	35/10/100/0 178/193/53 B2C135	25/0/84/0 200/219/82 C8DB52	15/0/22/0 216/235/207 D8EBCF	60/0/70/0 106/192/122 6AC07A	78/13/80/3 50/157/98 329D62	62/0/60/0 96/191/139 60BF8B
							
48/0/44/0 134/203/166 86CBA6	89/30/89/17 2/118/72 027648	75/3/60/0 37/177/138 25B18A	80/12/62/3 17/158/127 25B18A	60/0/35/0 93/195/181 5DC3B5	35/0/17/0 162/217/215 A2D9D7	50/0/25/0 122/203/199 7ACBC7	75/13/40/5 40/158/155 289E9B
							
30/15/20/0 179/195/195 B3C3C3	50/30/35/3 131/152/153 839899	16/0/5/0 211/236/239 D3ECEF	40/5/10/0 148/204/220 94CCDC	57/7/7/0 97/188/221 61BCDD	94/76/65/56 14/39/48 0E2730	77/25/0/0 0/152/213 0098D5	71/25/10/0 65/154/197 419AC5
							
60/10/0/0 83/182/231 53B6E7	21/12/12/0 199/208/212 C7D0D4	100/50/10/0 0/113/173 0071AD	68/21/0/0 62/162/218 3EA2DA	90/68/46/30 37/69/91 25455B	86/62/40/18 49/86/111 31566F	60/25/0/0 98/160/214 62A0D6	60/36/16/0 111/144/179 6F90B3
							
71/43/0/0 80/130/194 5082C2	87/65/0/0 47/99/173 2F63AE	100/85/23/5 31/68/128 1F4480	43/64/0/0 152/111/175 986FAF	24/40/0/0 190/157/201 BE9DC9	68/91/20/5 109/59/125 6D3B7D	44/86/0/0 153/71/154 99479A	4/52/29/0 234/144/148 EA9094
							
6/100/100/0 224/31/39 E01F27	0/68/41/0 242/117/122 F2757A	6/87/70/0 226/72/76 E2484C	25/16/18/0 190/197/197 BEC5C5	21/17/17/0 200/199/199 C8C7C7	12/6/6/0 221/227/230 DDE3E6	6/3/3/0 236/239/240 ECEFF0	3/3/3/0 244/242/241 F4F2F1

TYPOGRAPHY

The application of typography is an integral part of the City brand language and identity system. Consistent use of typography in all messaging improves the brand relationship with Edmontonians and City employees.

Use the recommended typefaces in all internal and external communications. Each typeface has been chosen for maximum readability and personality to align the visual style to the brand story.

It is important to choose the appropriate typeface(s) based on your content, usage requirements and digital application. Font substitution is prohibited and has a negative effect on our brand building process.

Additional fonts may be considered when used as display type or headlines in the promotion of events or limited duration programs where alignment to theme is beneficial in the advertising. Approval from the Brand Team is required prior to application.

Licenses will be required for any user of the primary typefaces. Typefaces may be purchased individually or as part of a multi-license.

**FOR QUESTIONS ON TYPEFACES, THEIR USES
AND ACCESS TO FONTS, PLEASE CONTACT:**

brandteam@edmonton.ca

PRIMARY TYPEFACES

PRIMARY SANS SERIF TYPEFACE

Prelo Pro is the primary sans serif typeface; use it for all titles, subtitles and advertising headlines. It is also to be used in all corporate materials directed toward an external audience.

The nine weights with true italics increase the range of use to provide varying degrees of emphasis while keeping subject matter aligned with the visual brand.

Prelo Pro is an extremely flexible typeface that includes open-type formatting for numbers, small caps, historical forms and ordinals.

PRIMARY SERIF TYPEFACE

Quercus 10 is the primary serif typeface. Serif styles marked by "10" are dedicated to textual point sizes and long reading.

With seven weights and proportional italics, this typeface is capable of extending its usage into report covers, posters and titling.

COMPANION SLAB TYPEFACE

As part of the Prelo Pro Super Family, Prelo Pro Slab is a neutral, highly readable typeface for identity, editorial and information design. Also with nine weights and italics, it too comes with the same versatility as its companion.

Font Purchase:

The City of Edmonton does not own a City-wide license for any of our three primary typefaces, and international copyright law forbids us from freely sharing the fonts both internally and externally.

If you are a colleague or vendor who needs to use these fonts, single user or group licenses can be purchased [here](#).

PRELO PRO SPECIMEN

Prelo Pro Medium



Prelo Pro Light

12 / 15 pt

ABCDEFGHIJKLMNOPQRSTUVWXYZ
abcdefghijklmnopqrstuvwxyz
0123456789 – ()@#?!

PRELO PRO WAS DESIGNED TO BE A NEUTRAL, HIGHLY READABLE TYPEFACE FOR IDENTITY, EDITORIAL AND INFORMATION DESIGN. With nine weights and nine true italics, from Hairline to Black, Prelo Pro is a workhorse typeface, full of OpenType features such as Small Caps, Tabular Figures, Central Europe characters and Historical Figures, among others.

Prelo Pro Book

ABCDEFGHIJKLMNOPQRSTUVWXYZ
abcdefghijklmnopqrstuvwxyz
0123456789 – ()@#?!

Prelo Pro Semi-Bold Italic

ABCDEFGHIJKLMNOPQRSTUVWXYZ
abcdefghijklmnopqrstuvwxyz
0123456789 – ()@#?!

9 / 13 pt

Prelo Pro Black Italic

ABCDEFGHIJKLMNOPQRSTUVWXYZ
abcdefghijklmnopqrstuvwxyz
0123456789 – ()@#?!

Like other DSTYPE fonts, most of the diacritics were designed to fit the gap between the x-height and the caps height, avoiding some common problems with the accented characters. The curves are soft and smooth, providing legibility, even in very poor conditions.

QUERCUS 10 SPECIMEN

Quercus Book 230 pt



Quercus 10 Thin

12 / 15 pt

ABCDEFGHIJKLMNOPQRSTUVWXYZ
abcdefghijklmnopqrstuvwxyz
0123456789 – () @ # ? !

THE SERIF LETTERFORM IS RATHER MINIMALISTIC WITH SUBTLE SHADOWS AND THINNED JOINTS BETWEEN CURVED SHAPES AND STEMS. Quercus family offers features such as Small Caps, Cyrillics, diacritics, ligatures, scientific and aesthetic variants, swashes and other bells & whistles.

Quercus 10 Regular

ABCDEFGHIJKLMNOPQRSTUVWXYZ
abcdefghijklmnopqrstuvwxyz
0123456789 – () @ # ? !

Quercus 10 Medium Italic

ABCDEFGHIJKLMNOPQRSTUVWXYZ
abcdefghijklmnopqrstuvwxyz
0123456789 – () @ # ? !

9 / 13 pt

Quercus 10 Black Italic

ABCDEFGHIJKLMNOPQRSTUVWXYZ
abcdefghijklmnopqrstuvwxyz
0123456789 – () @ # ? !

Quercus is characterized by open, yet slightly condensed drawing with sufficient spacing so neighbouring letters never touch. It has eight interpolated weights with respective italics. This fine gradation gives designers a wider range of options for their designs, especially on the web.

PRELO SLAB PRO SPECIMEN

Prelo Slab Pro Light 230 pt



Prelo Slab Pro Hairline

12 / 15 pt

ABCDEFGHIJKLMNOPQRSTUVWXYZ
abcdefghijklmnopqrstuvwxyz
0123456789 – () @ # ? !

PRELO PRO SLAB IS THE SERIF COMPANION TO PRELO; A NEUTRAL, HIGHLY READABLE TYPEFACE FOR IDENTITY, EDITORIAL AND INFORMATION DESIGN. With nine weights and nine italics, from Hairline to Black, Prelo Slab Pro is a workhorse typeface, full of OpenType features such as Small Caps, Tabular Figures, Central Europe characters and Historical Figures, among others.

Prelo Slab Pro Book

ABCDEFGHIJKLMNOPQRSTUVWXYZ
abcdefghijklmnopqrstuvwxyz
0123456789 – () @ # ? !

Prelo Slab Pro Semi-Bold Italic

***ABCDEFGHIJKLMNOPQRSTUVWXYZ
abcdefghijklmnopqrstuvwxyz
0123456789 – () @ # ? !***

9 / 13 pt

Prelo Slab Pro Black Italic

***ABCDEFGHIJKLMNOPQRSTUVWXYZ
abcdefghijklmnopqrstuvwxyz
0123456789 – () @ # ? !***

Like other DSTYPE fonts, most of the diacritics were designed to fit the gap between the x-height and the caps height, avoiding some common problems with the accented characters. The curves are soft

SYSTEM TYPEFACES

These typefaces have been identified as “common” on all Mac and PC platforms, ensuring type will display in a consistent manner.

This includes all cross-platform applications such as Microsoft® Powerpoint, Word and Excel in addition to email programs like Outlook.

These typefaces are typically available as system fonts and do not require downloading and installation.

Arial Regular 90 pt

Arial

ABCDEFGHIJKLMNOPQRSTUVWXYZ
abcdefghijklmnopqrstuvwxyz
0123456789 — () @ # ? !

ABCDEFGHIJKLMNOPQRSTUVWXYZ
abcdefghijklmnopqrstuvwxyz
0123456789 — () @ # ? !

Times New Roman Regular 90 pt

Times NR

ABCDEFGHIJKLMNOPQRSTUVWXYZ
abcdefghijklmnopqrstuvwxyz
0123456789 — () @ # ? !

ABCDEFGHIJKLMNOPQRSTUVWXYZ
abcdefghijklmnopqrstuvwxyz
0123456789 — () @ # ? !

GOOGLE TYPEFACES

Google apps and business tools are part of the City's internal communication protocol. With the transition from desktop to web-based applications, it's important to demonstrate consistent behaviour in all internal documents.

Google Fonts are open-source and universal in their application and require no special attention.

Open Sans Regular 80 pt/(-40) tracking

Open Sans

GOOGLE fonts are available for use privately or commercially – in print, on your computer, or in your websites.

ABCDEFGHIJKLMNOPQRSTUVWXYZ
abcdefghijklmnopqrstuvwxyz
0123456789 – () @ # ? !

ABCDEFGHIJKLMNOPQRSTUVWXYZ
abcdefghijklmnopqrstuvwxyz
0123456789 – () @ # ? !

Download information for each of these typefaces can be found at:
www.google.com/fonts

PT Serif Regular 90 pt

PT Serif

ABCDEFGHIJKLMNOPQRSTUVWXYZ
abcdefghijklmnopqrstuvwxyz
0123456789 – () @ # ? !

ABCDEFGHIJKLMNOPQRSTUVWXYZ
abcdefghijklmnopqrstuvwxyz
0123456789 – () @ # ? !

SETTING TYPE BASICS

Type design is an integral part of daily communication with internal staff and the public. The following rules will help you manage document layout and presentation, while ensuring the typography matches the message and brand vision.

Headlines are set with (-10) letter spacing and leading equal to PT size. Headlines should be 3-4 words per line and not exceed 6 columns.

Headlines are black, mixed case set over multiple lines

Titles are set with both style and colour matching content and tone. Titles should be minimum 50% smaller than headlines. Titles can also be in a complement colour. Leading is PT size x 1.125.

Titles can be set in an alternate font style

Headlines should be the largest and most distinct type element on the page, and set in either Prelo Pro Black or Prelo Pro Hairline for maximum graphic effectiveness. Prelo Slab Pro Light *MAY BE USED* occasionally for emphasis or variety.

Type is ALWAYS set flushed left—ragged right

Default body copy is Prelo Pro Book, the preference for all printed communication. Whether body copy is set in Prelo Pro or Quercus 10, leading (line spacing) is always the type point size x 1.5.

Headers and footers may be set in contrasting typefaces such as the example shown below set in 6 pt Prelo Pro Slab Semi-Bold.

DISPLAY HEADLINES ARE IN SMALL CAPS WITH TIGHTER LINE SPACING

Titles can be set in any complement colour

The body copy alternate is Quercus 10. It can be used for more formal documents or for publications with longer text such as reports or book-length material.

Additional information, callouts and captions can be set in unique variations of the primary typefaces

Quercus 10 Italic is another alternate body copy option. It adds a lighter, more relaxed feeling to the text and brightens the emotional tone of a publication.

CITY SYMBOLS

Edmonton has several official symbols that have been carefully designed to represent our unique heritage and character. These symbols are an important part of our culture and should always be used in an appropriate and intended manner.

THE CITY CREST is our City's Coat of Arms identifying Edmonton as the capital of Alberta in 1905.



THE CITY FLAG represents the City of Edmonton with a triband design featuring the City Crest within a white and blue design, symbolizing peace and the North Saskatchewan River.



THE MARIGOLD (OFFICIAL FLOWER) represents sunny Alberta and Edmonton's role in the Klondike Gold Rush of the 1890s. Like the many varieties of marigolds, our city proudly blooms with diversity.

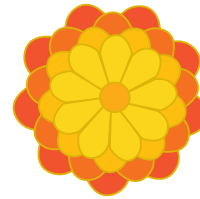

Usage Information:

For additional information regarding usage of the official symbols, please contact brandteam@edmonton.ca.

PHOTOGRAPHY

At the core of visual storytelling, good photography allows the City brand to express itself in an authentic and compelling manner. Every photo should communicate the value of connection – demonstrating a connection to Edmontonians, to each other as employees and to the moments shared within our city.

All images used must be professional quality and local. Capturing real-life situations is preferred over staged scenes.

PEOPLE

All photos of people should capture them in a manner that shows connection in a natural setting. This may be a connection with a physical object, other people, an environment, etc. The quality of the interaction will begin to tell the story, increasing the value of the message.

LEGAL REQUIREMENTS

When people can be recognized in photos and video in photography and videography, care must be taken to comply with the requirements of the Alberta Freedom of Information and Protection of Privacy Act (FOIP). FOIP requires the written consent of the individual, and the consent must set out how the photo will be used. Before beginning a new photo shoot please contact Communications and Engagement to ensure the proper permissions and releases are in order.

License-free photos with the appropriate releases are available through the City's employee intranet Digital Asset Manager, or, the City's place brand microsite [Why Edmonton](#).

ENVIRONMENT

To show audiences how amazing our city can be, and encourage a greater personal connection, all photos of Edmonton's natural environment should capture the beauty in a way that emphasizes a unique landmark, region or feature. Unique angles, cropping and depth of field help to create emotion and inspire connection.

STRUCTURES AND ARTIFACTS

Photos of these subjects should tell a story of our past or anticipated future while making a community connection. Use of a shallow depth of field can add interest to a composition and highlight your subject.

PHOTOGRAPHY SELECTION



SUBJECT FOCUS

Focus on the individual or group—and what transforms a connection to an experience. Use shallow depth of field to isolate the subject and create a moment.

SITUATION

Focus on the action and pull the viewer into the moment when the connection was made. Create genuine interest and desire to be there.

MOTION

Place stationary subjects in an active environment to imply dynamic activity, speed, motion and focus.

TYPE ON PHOTOGRAPHS

As a general rule, type should not be set over photographs. Type should be set on either white backgrounds or colour blocks.

The logo may be placed over photographs as long as it is positioned correctly on grid and has enough contrast to stand out from the background image.

PHOTOGRAPHY CROPPING

Cropping a photo should enhance the subject and improve the overall message while creating a more intimate setting. The feeling and depth of story you wish to tell should determine the amount of cropping and the figure–ground relationship.

Be careful not to crop photos that will require them to be enlarged, turning them into low resolution images unsuitable for printing.



VIDEO

Similar to our approach to photography, videos should communicate the value of connection – demonstrating a connection to Edmontonians, to each other as employees and to the moments shared with our city.

With scripted or animated videos, ensure the voice is open and conversational. Avoid jargon and overly formal or corporate-sounding language.

When interviewing people, ensure soundbites don't sound overly scripted. Tell a story instead of reciting key messages. Select clips which reflect the personality of the speaker while reinforcing the City voice. Maintain visual interest by using b-roll instead of just "talking head" shots for long periods of time.

INTROS AND OUTROS

Intros may vary by campaign or topic. In general, only use an intro screen or animated graphic for a series of videos. If there is an intro or watermark, ensure the main type is Prelo Pro SemiBold and any supporting fonts have a visual hierarchy that provides contrast.

ONE [LENGTH] DOESN'T FIT ALL

Make sure the length of your videos are tailored for the platform they're being shared on. As a general rule, it's best to keep videos under two minutes but each platform has its own sweet spot when it comes their users:

- Facebook: one minute
- Twitter: 45 seconds
- Instagram: 30 seconds
- Youtube: two minutes

Source: [Hubspot Study](#)

Always check current best practices and any available analytics on audience retention and drop-off to help guide your strategy.

Generally, all videos should end with the standard City animated bumper.



VIDEO

TITLE BARS AND LOWER THIRDS

When adding lower thirds in a video, leave adequate space for closed captioning. For example, for a 4k video, leave 80 px between the two elements. Animations should be simple and not too distracting; either a fade in or a swipe from left or right depending on placement.

Formatting:

Name: Prelo Pro SemiBold, 65 pt

Title/Organization: Prelo Pro Book, 50 pt

When interviewing City of Edmonton staff, only use 'City of Edmonton' as the person's title. If relevant to the topic, staff can identify the area they work in verbally during the interview itself.

For interviews with external partners, agencies, organizations and elected officials and dignitaries, use their complete title and organization name.



VIDEO

ON SCREEN TEXT

Formatting

Text Lower Third: Prelo Pro SemiBold
Text Background Colour (optional): HEX: #005087,
RGB: 0/80/135, Opacity: 85%

White Text, No Background

Lower thirds should have a solid white colour with a drop shadow to increase contrast and readability.

Text, Coloured Background

If there isn't enough contrast between the text and background, use coloured background text.

DIGITAL ACCESSIBILITY

Closed Captioning

All videos must include closed captions. Captions should be sent as a separate subrip subtitle (.SRT) file to be uploaded with the video. Ensure Canadian Press Stylebook rules are applied for spelling and grammar.

Readability

Ensure that there is enough contrast between the text and the background. Text should be in title case, no longer than three lines and either left or right aligned, depending on the framing of the video. Be mindful of font sizes; since videos are viewed on multiple devices including mobile devices, always quality test your video to ensure text is easily readable.

Audio

For clear audio, use an external mic when interviewing people. Background sounds or music can sometimes be distracting. Quality test your levels to make sure important information can easily be heard.

INDIGENOUS AND MULTICULTURAL TEXT

When capturing Indigenous or multicultural text, use the appropriate language keyboard for special characters. If possible, provide a translation in English for the word or phrase.



ICONS

Icons can be great visual cues to reinforce and add clarity to our messages. You'll find icons used in our web design, maps, wayfinding and to help communicate steps in a process. We use both a solid and line-based icon set that is based on global symbols from [FontAwesome](#). Style options should be chosen according to size, medium and impact. They can be sized from 16 to 192 px. Below are a small selection of a library of over 7,800 icons.

If you are using Google Workspace, you may find converted graphic files in the City icon library. Please contact brandteam@edmonton.ca for access.

THIN-LINE

Digital size range:
48x48px - 192x192



REGULAR-LINE

Digital size range:
24x24px - 48x48px



SOLID

Digital size range:
16x16px - 24x24px

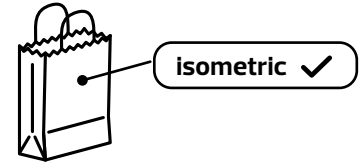
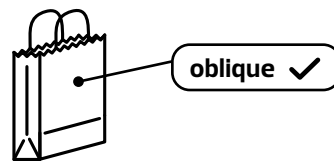
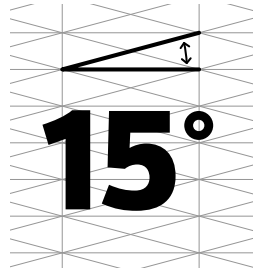

DIAGRAM ILLUSTRATION STYLE

The diagram style is a pictorial graphic system. Diagrams can bypass language and accessibility barriers by translating verbal and written content into a simple and universal visual form.

KEY CHARACTERISTICS

- technical
- instructive
- specific
- functional



ROUNDED CORNERS AND STROKE CAPS

FULL LINE WIDTH

HALF LINE WIDTH

DOTTED / DASHED LINES

Line-based graphics enable the use of functional colour overlays and colour fills to bring focus to content. Directional elements like arrows and area

boundaries help the user understand a situation. Unnecessary visual information that is unrelated to the subject at hand is deliberately not included.

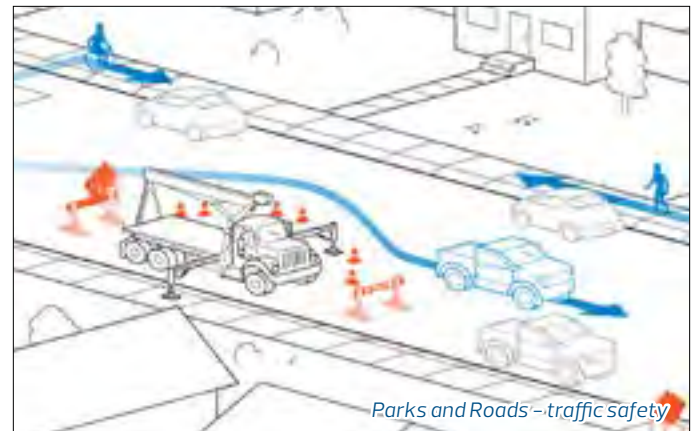

USING COLOUR

Colour is used strategically and intentionally excluded to bring attention to people, objects, processes and systems.

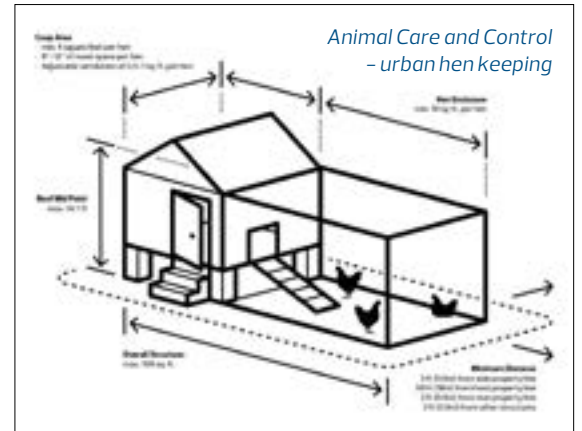
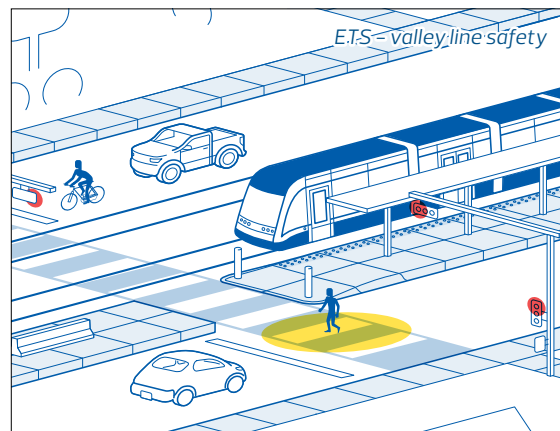

DIAGRAM STYLE PICTOGRAPHS AND ICONS

Objects, places or actions are derived and clarified by removing visual noise and treating every detail with intention. The diagram style conveys the essence of a subject with the least amount of information.

Concepts like temperature, invisible odour or vapour, wetness, transparency and material composition can be expressed with illustrated cues.

BASIC OBJECTS

These graphics are drawn consistently with only a single thickness of line.



SIMPLIFIED VISUALS

Certain details are removed to allow the graphic to scale down to small sizes.



ARTICULATING DETAIL

Graphics may be drawn with the full and half thickness of line to show finer details and to articulate different states of matter like vapour or liquid.

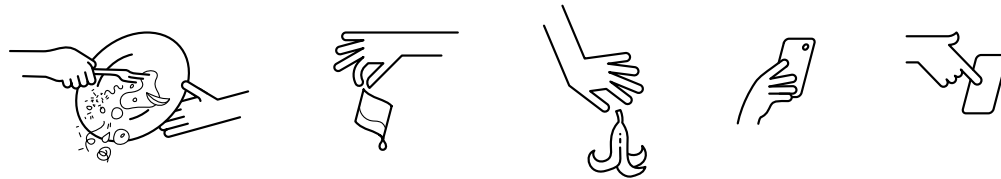

DIAGRAM STYLE SYMBOLS

Sub components of the diagram style are similar to iconography but are embedded in the diagram style.

Shapes like arrows, x's, check marks and restriction symbols emphasize an action or process.

MATERIAL SYMBOLS

Some diagrams need an added detail (i.e. WHMIS symbols to indicate hazardous materials).



ACTION SYMBOLS

These graphics are able to break from the line consistency rule, and be increased in weight for emphasis.



MOSAIC ILLUSTRATION STYLE

The mosaic style is intended to express overarching and aspirational themes. It is used to connect the City's programs and services in an abstract but unified way.

This style of illustration is reserved to applications that have long-term exposure - for example City website graphics, a mural backdrop or vehicle wraps.

KEY CHARACTERISTICS

- expressive
- emotional
- whimsical
- abstract

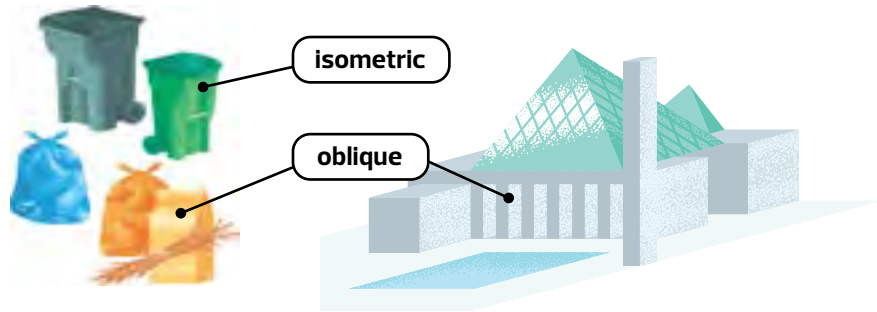
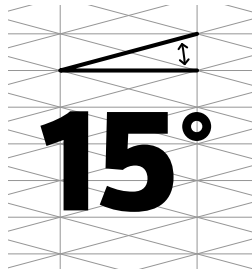

GRAPHIC APPEARANCE

- geometric forms
- organic forms
- stippling texture
- light knockouts
- detailed heroic imagery
- 15 degree alignment
- mosaic tile base



ILLUSTRATING PEOPLE

Styles of illustration widely vary and some details are important when showing people. We keep in mind aspects like proportion of the head to body, articulation of limbs, hands and fingers, or the ability to position the figure within a 3D environment.

In the diagram style, when human figures are shown at a small size they revert to a solid silhouette (with no outlines). When they're larger in size, more details can be included.

KEY CHARACTERISTICS

- anatomical
- rounded
- articulated
- proportional
- expressive
- simple
- dynamic
- consistent



STYLE

Keep it simple. Illustrate figures with flat geometric forms or in a consistent outline. Refrain from using stereotypes and avoid cliché human characterizations. Ensure figures represent broad range of people in age, outward expression and ability.



THINGS TO AVOID

- exaggeration (i.e. hunched back or no neck)
- blank or vacant faces (i.e. dot eyes or missing brows)
- rigidity or stiffness (i.e. flat back or locked knees)
- inconsistency (i.e. mis-matched styles)
- disproportioned body parts (i.e. tiny head)
- juvenile or oversimplified (i.e. doll or toy like body)
- sharp forms (i.e. pointy elbows or knees)

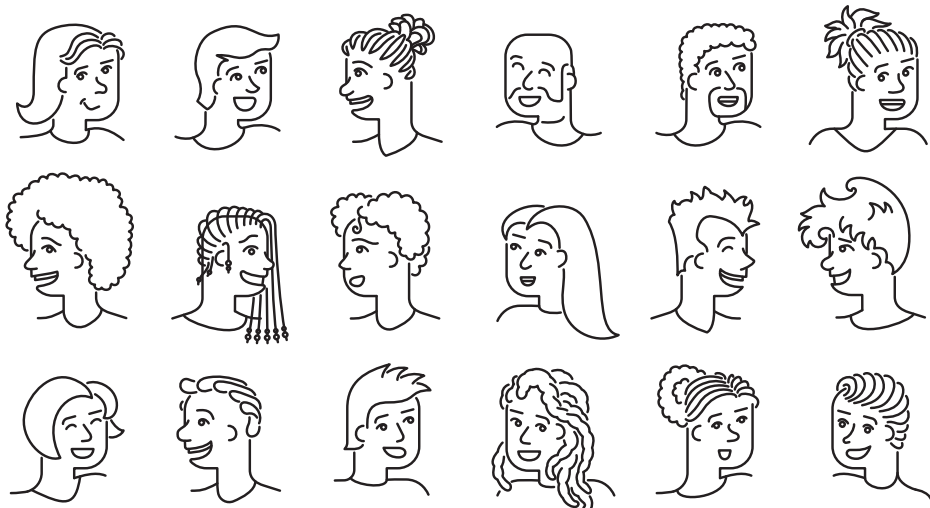

FIFTEEN DEGREE GRID SYSTEM

The perspective grid system for both diagram and mosaic styles are set to 15 degrees which allows for a compact scene and increased depth compared to grids set at a wider angle – typically 30 degrees.

This sharper 15 degree angle results in the viewer's position feeling relatively lower – like looking down from the top of a tower versus a bird's eye view positioned higher in altitude.

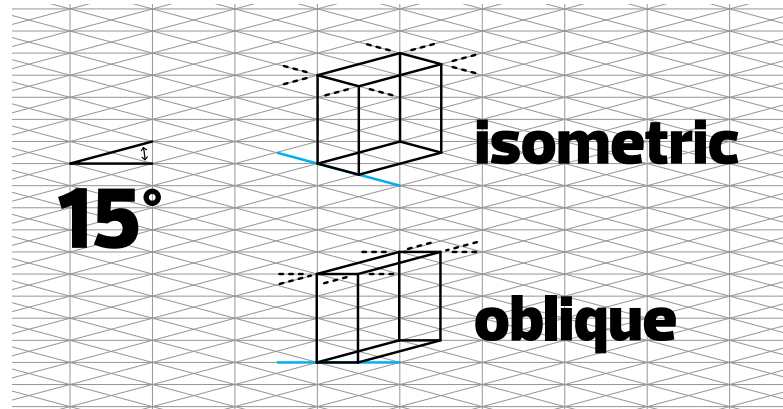

OBLIQUE PERSPECTIVE

Objects can be drawn using the oblique grid – in some cases, breaking from the isometric perspective is intentional (i.e. mosaic style landmarks, or bulky objects like a cardboard box or paper bag.)

Avoid using oblique perspective when showing a real-world scene. Stick to isometric perspective when a 3D environment is needed to communicate the content of the subject.

MOSAIC TILING

Generated by the 15 degree angle, a triangle can be reflected, rotated and combined to create a wide variety of mosaic tile shapes. These tiles serve as visual linking devices across several City visual identity communication pieces.

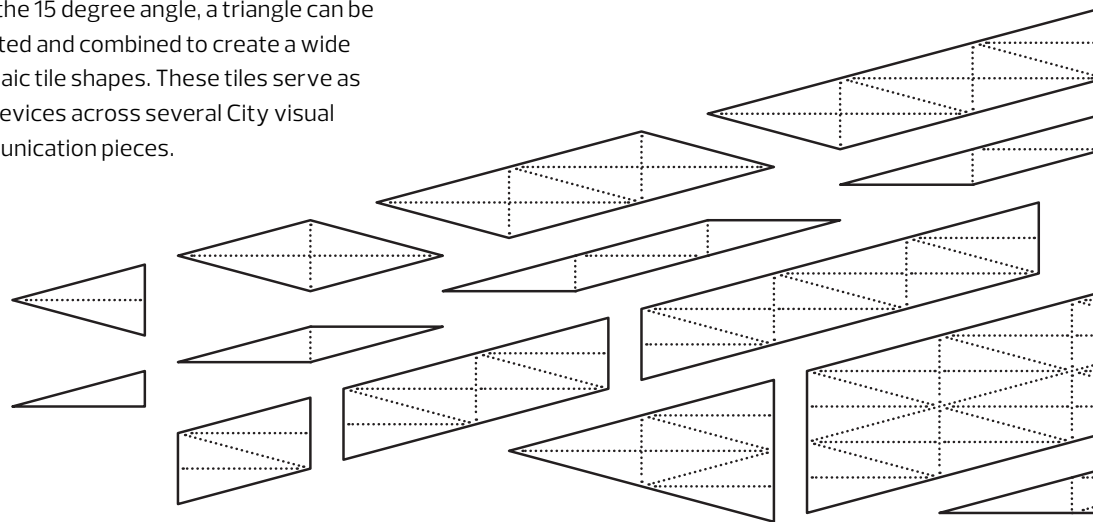

ILLUSTRATED BACKGROUNDS + PATTERNS

Patterns are used to create visual interest and give design flexibility when apply to a layout. It is a subtle yet effective way to express your brand. A minimal graphic approach is used over a square grid.

A line-based style is used highlighting key themes that are important to the subject matter.

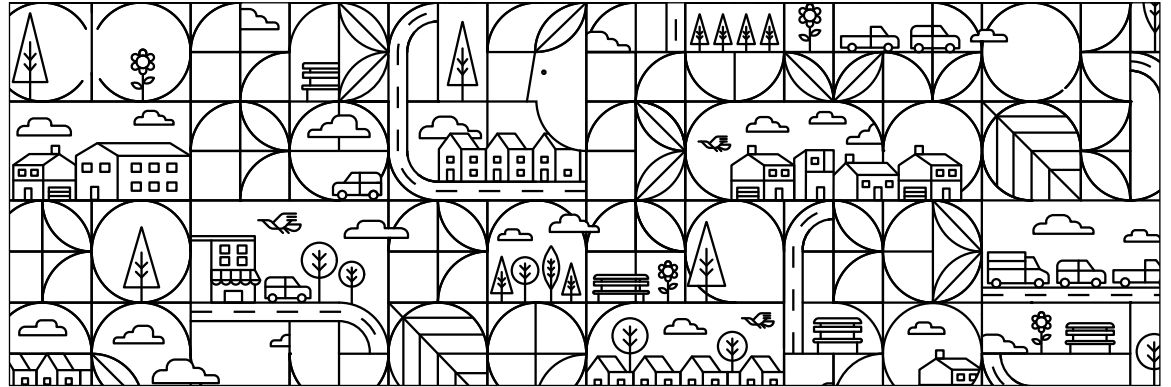

The square motif as a solid shape style is used internally for general messaging that accompany the City's Cultural Commitments.

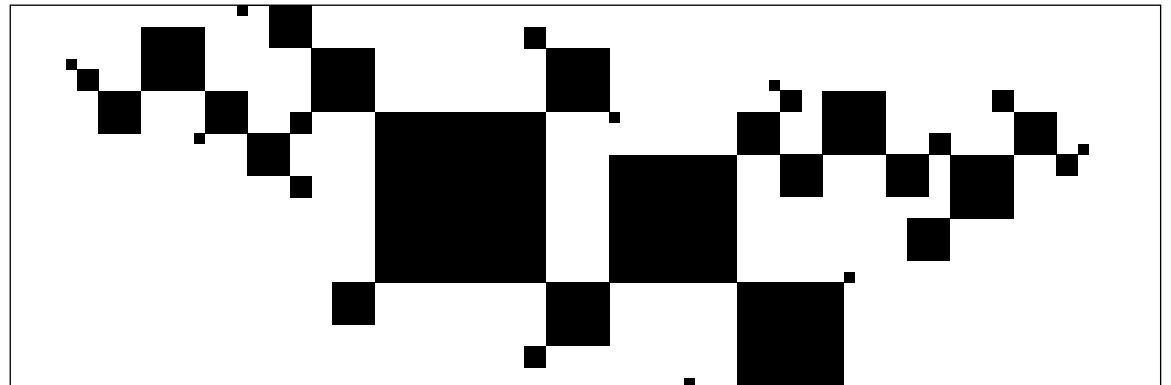

The square motif as a line-based style is used internally for formal celebratory applications that accompany cultural commitments recognition.

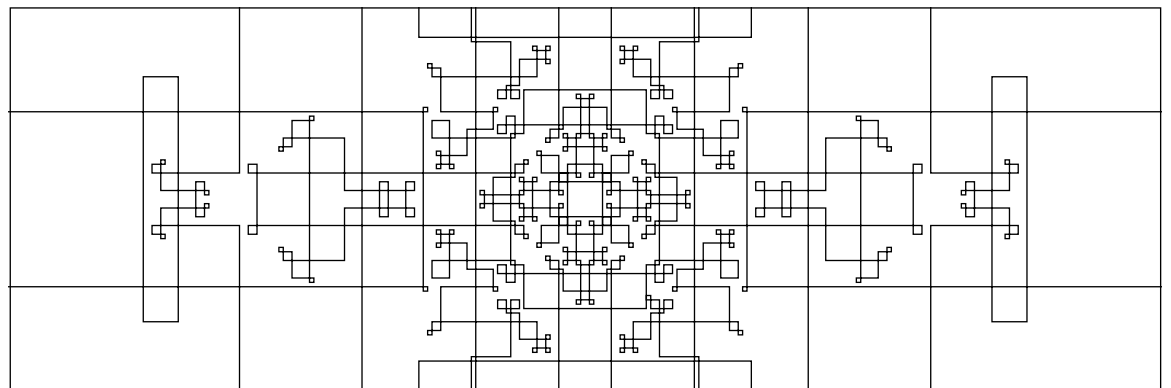

THE GRID SYSTEM

The City logo must be present on all corporate communication and advertising materials.

To ensure visual consistency in logo placement, we have developed a grid system based on the golden ratio. It creates multiple variations for placement of the logo by creating relationships to the position of text and image. Positioning and size of the logo is determined by the size and type of media, the number of grid units and the content bound to the grid.

BUILDING THE GRID

1. Determine the orientation of your production. This affects the positioning of the horizontal rules.
2. Set your margins based on the guide. Use these measurements and consult with the Visual Identity Team for larger formats.
3. Create the columns within the text margin.

PLACEMENT OF DESIGN ELEMENTS

1. Establish your principal photos and any additional graphic elements.
2. Insert photo and mask according to the margins. Ensure that there is sufficient contrast and legibility for typography, illustrations and the Edmonton logo.
3. Determine a size for the content box. Choose colour based on content, theme and mood.
4. Place the typographic elements in the content box. Align content box to the grid units. Depending on the content requirements, the column widths for texts are determined individually. The maximum width for body copy is four columns.
5. Place the Edmonton logo. See page 47 for placement options based on the master grid.

GRID

A properly constructed grid allows a variety of image and content layouts, while ensuring the integrity of the visual language is preserved.

Grids for layouts larger than US Letter should use 10 columns within the text margin.

Grids for layouts smaller than a standard U.S. letter size should use 6 or 4 columns.

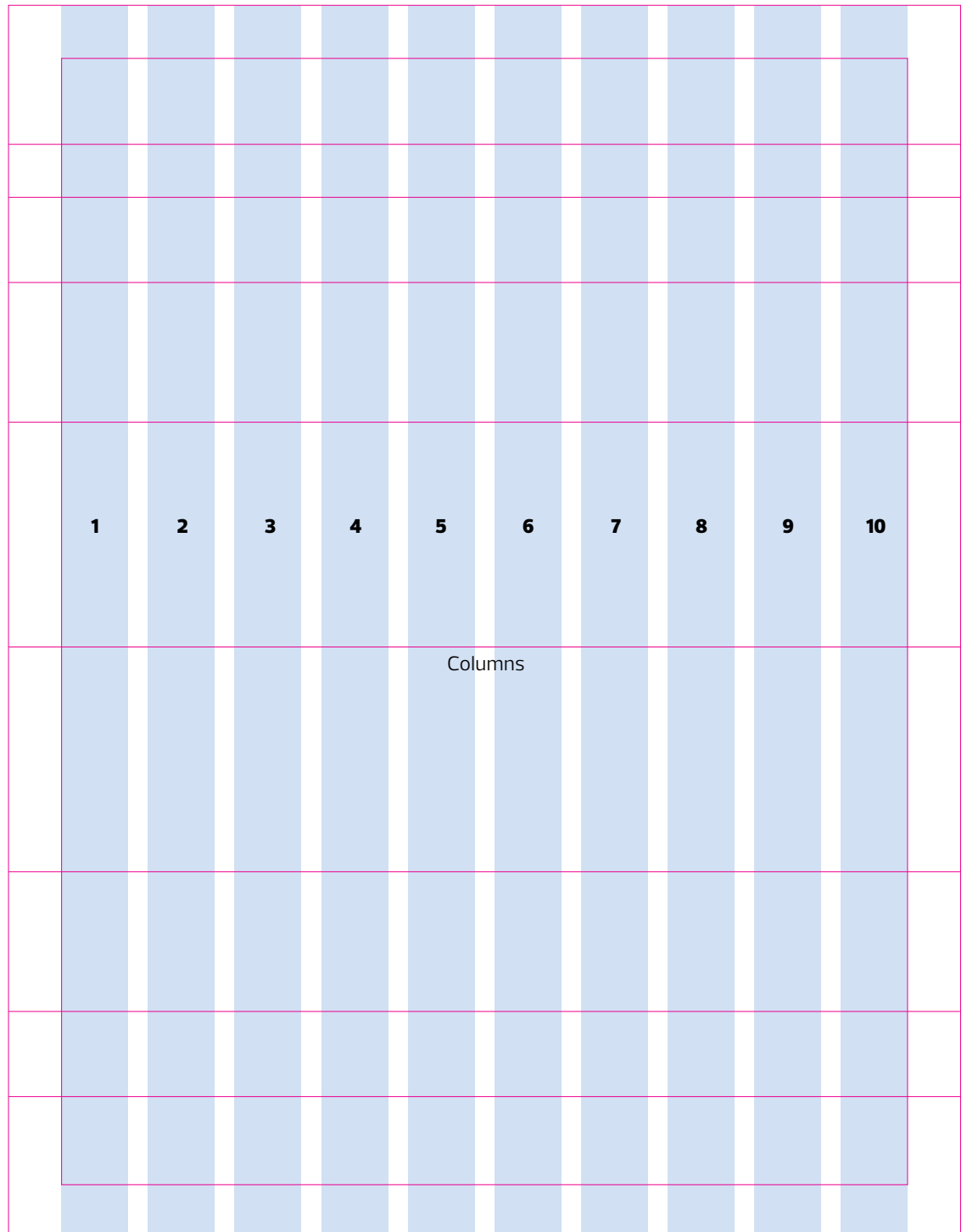

PRIMARY LOGO STAGING

The grid allows for flexibility while establishing rules for placement of the logo. This helps to ensure immediate brand recognition. Default position of the logo is *RIGHT EDGE*.

OPTIMUM VISIBILITY

The City logo should be placed for best visibility given the media. There is no preference in vertical position.

VERTICAL ALIGNMENT

The logo may rest on any horizontal grid unit with alignment to either the top or bottom of the logo.

BLEED OR NO BLEED

The logo may be placed within the margin or affixed to the edge depending on the media and production limitations.

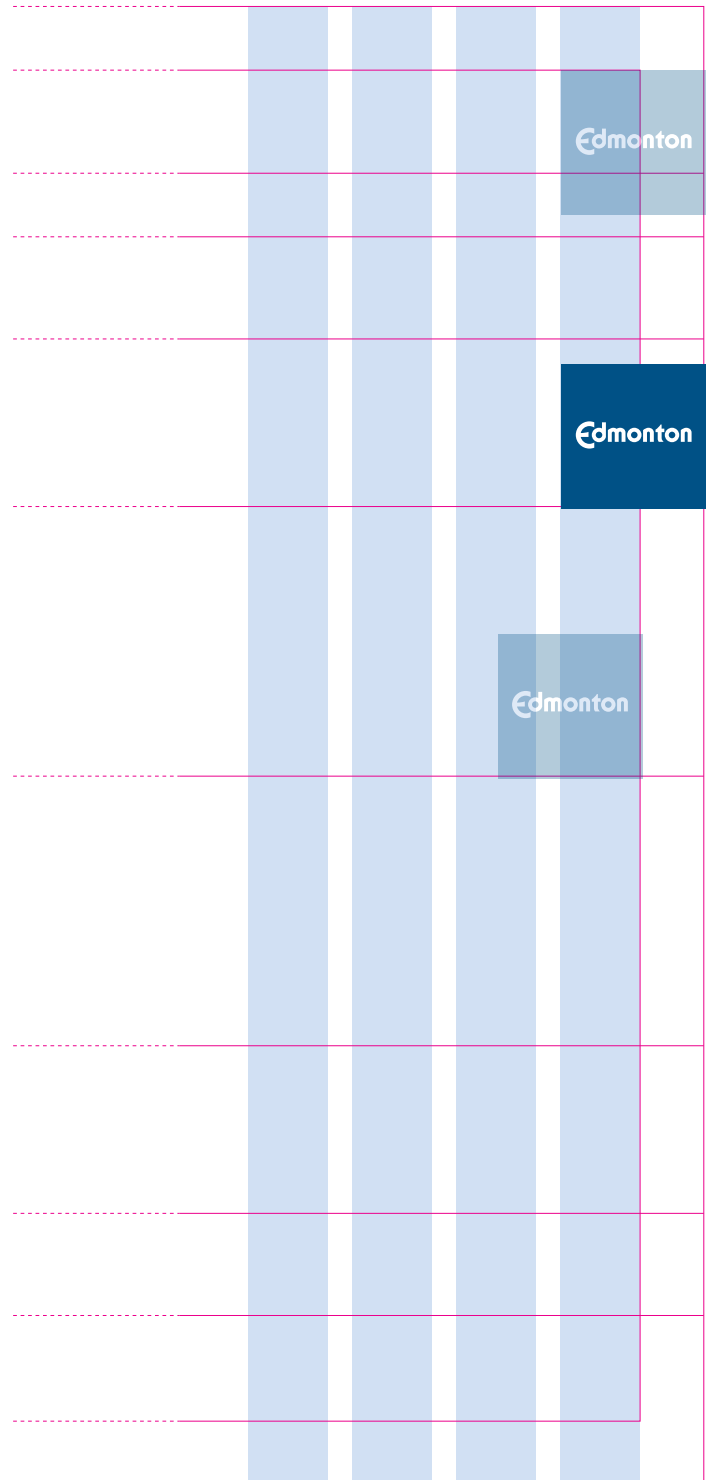

ARRANGEMENT

The following is an example of how type, photography, shape and colour are combined with the logo to create a distinct City of Edmonton expression.

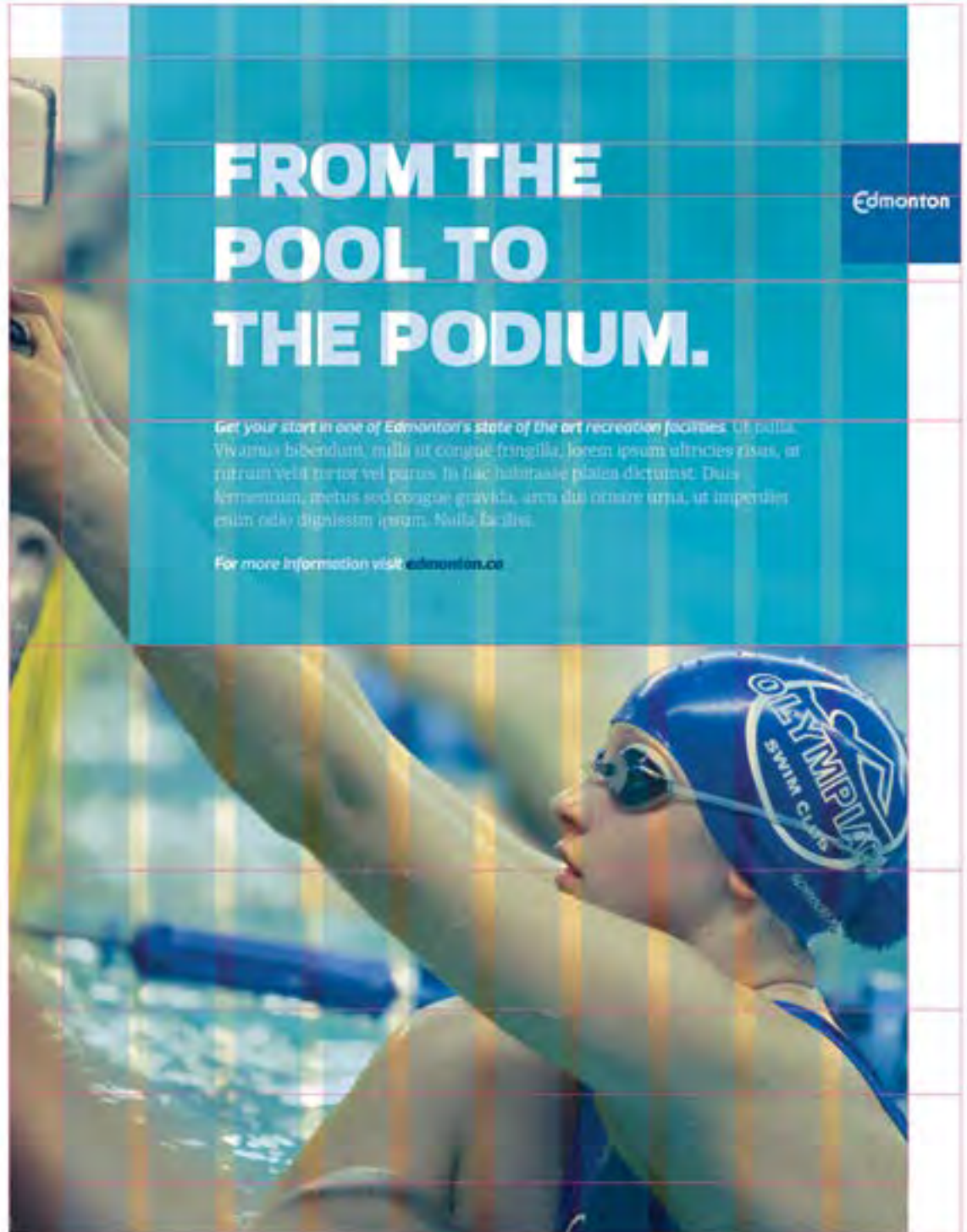

STAFF UNIFORMS

Staff uniforms provide visual cues to identify employees, enhance customer service and build brand recognition.

PRIMARY

A blue shirt is to be used primarily throughout all City run operations. The **reversed white logo** is to be printed on the front left side of the chest. The logo can be size to a maximum of 1.75"

The word **STAFF** is centred on the back of the shirt and set in the font **Prelo Pro Bold Small Caps**.

If a white shirt is required the primary logo is to be used. The word **STAFF** is centred on the back of the shirt and set in the font **Prelo Pro Bold Small Caps**.

LIFEGUARDS

The black logo is to be used for all lifeguard tank tops. The logo is to be printed on the front left side of the chest. The word **LIFEGUARD** is centred in black on the back of the shirt and set in the font **Prelo Pro Bold Small Caps**.

If there is a business case for a different shirt colour or alternate wording on the back, please contact the brand team for approval.



PROMOTIONAL ITEMS

The City of Edmonton is committed to fiscal responsibility and sustainability. We need to make informed choices before ordering promotional items or 'swag'.

The following questions will help you consider if ordering promotional items is an effective use of taxpayer dollars. Please loop in your area's communications advisor for these conversations.

- How does the item support your business goals?
- How will people use it? Is it safe and of value?
- Have you considered GBA+ and people with various abilities?
- Have you looked at cultural or social sensitivities?
- Will people know this is from the City? Is this adding to the positive and consistent experience of our brand? Is it functional (for example, does it help identify staff or volunteers)?
- Is this item worth investing in? How could it positively (or negatively) influence what people think of the City?
- Can it be used more than once? What are the environmental impacts if people don't find it useful and discard it? Consider the carbon footprint of the production, packaging and distribution of the item.
- Can the item be sourced locally? Is the manufacturing ethical?
- Are you following [City procurement policies and practices](#)?



Promotional items should support business goals, be on brand and be useful, relevant and of value. If you are proceeding with an order:

- Identify items with the primary (blue square) version of the City logo when possible. Maintain clear space and minimum size requirements. If alternate logo versions are required, please contact brandteam@edmonton.ca for review and approval.
- Don't make items program or project specific or include department, branch, section or unit names. This isn't necessary or relevant information for Edmontonians. Additionally, it limits item use and shelf-life (for example, leftover items can't easily be reused by other areas and if anything with the program or project changes, these items may become obsolete).
- Consider alternatives if you're thinking of ordering apparel for general giveaway to the public. Branded clothing can give the impression of a uniform and suggest the person wearing it is employed by the City. This can cause confusion and could have reputational implications.
- Please have all proofs approved by brandteam@edmonton.ca before moving forward with production.



NOMENCLATURE

Logo file naming convention

EDM_SIG_P_2COL.EPS



1. City Identifier
2. Designates primary or secondary logo
3. Colour type
4. File type (eps, tiff, jpeg, gif)



EDM_SIG_P_CMYK.AI

Primary Logo
CMYK Colour
Adobe Illustrator vCS4



EDM_SIG_P_B.EPS

Primary Logo
Black Colour
Encapsulated Postscript (Universal)



EDM_WORDMARK_PMS2945.AI

Wordmark
PANTONE 2945 Colour
Adobe Illustrator vCS4

GLOSSARY

BRAND – What people think and feel about an organization, company or product. It can be negative, positive or anywhere in between.

BRAND EQUITY – Branding guides all of our touchpoints with Edmontonians across all areas. Over time, this fosters positive experiences, improves relationships and builds trust. When people's perception of our organization starts to match what we want to be known for, we create positive brand equity.

CMYK – Cyan (blue), Magenta (red), Yellow, Key (black). Used in offset and some digital printing, these four inks are mixed to reproduce colours that are printed on paper or other surfaces.

COATED & UNCOATED – Types of paper stock used for printing. Coated paper contains a high clay content polished to a smooth finish which can be dull, matte or gloss. Uncoated paper contains no clay and has a dull surface (e.g., copy paper). Inks absorb differently on different paper stocks, changing in tone and intensity.

CONTRAST – The difference between light and dark areas in an image. The wider the tonal range in an image, the lower the contrast.

EPS – Encapsulated Post Script. A graphic file format best used for offset printing. Can be vector (line) or pixel (dot) based. Usually created in Adobe Illustrator or Photoshop.

HEX – The hexadecimal number system is a way of representing Web colours in HTML. Each successive digit or number represents a multiple of a power of 16. It uses the digits 0–9 plus the letters A, B, C, D, E, F, and G.

JPG – Joint Photographic Experts Group. Commonly used method of compression for photographic images. Good, all-around format for Word or PowerPoint.

LOGO – A graphic element often locked with a wordmark to form a visual for an organization's brand.

PANTONE – The Pantone Color Matching System (PMS) is a standardized colour reproduction system that allows different manufacturers in different locations to match colours without direct contact with one another.

PNG – Portable Network Graphics. The png format is a popular alternative to gif, using better compression and not limited to 256 colours. Not suitable for professional photo images. Transparent backgrounds will remain transparent, instead of appearing white in a document or presentation.

RGB – Red, green, blue. Additive colours used by electronic displays, such as televisions and computers, to reproduce colours. Colour can vary screen to screen unless all monitors are uniformly calibrated. Image files created in RGB can be embedded into Word or PowerPoint files, which can then be outputted on most inkjet and laser printers.

SERIF – A serif is a small line used to finish off a main stroke of a letter. A typeface that has serifs is called a serif typeface. A typeface without serifs is called sans-serif, from the French *sans*, meaning "without." For body copy serif fonts are generally considered more readable on printed materials, while sans-serif is considered more legible on computer screens.

SIGNATURE – Any combination of a logo or mark and logotype or wordmark, which serves as an official identity element.

TINT – A gradation of a colour made by adding white to it or lightening it to lessen its saturation.

TRADEMARK – One or a combination of words, designs or sounds used to distinguish the goods or services of one person or organization from those of others. A trademark may be unregistered or legally registered, and the owner of the trademark has legal rights which restrict the use of the trademark by others.

WORDMARK – A standardized graphic treatment of a trade name to identify and brand a company, institution or product.

FINDING ASSETS

For access to logos, swatch libraries, artwork templates and other creative files, please direct requests through your communications advisor or contact brandteam@edmonton.ca.

LIST OF AVAILABLE ASSETS:

- Logo in all colour versions and formats including Hex (web), CMYK, RGB, Pantone® in jpg, png, tif, ai, eps
- City Crest in all versions and formats
- Primary colours (PMS values available in this document) as Hex (web), CMYK, RGB, Pantone® in jpg, png, tif, ai, eps
- Complement colours in all versions and formats including Hex (web), CMYK, RGB, Pantone® in jpg, png, tif, ai, eps
- Grid layout templates for InDesign and Adobe Illustrator
- Official fonts (not City-supplied; only available from suppliers listed on P 27 – 28 of this document)

For questions or advice on applying Visual Identity Standards, contact brandteam@edmonton.ca.

** Visual Identity assets may only be used by City of Edmonton employees and their authorized suppliers for the sole purpose of communicating and promoting the policies, services and facilities of the City.*

CONTACT

VISUAL IDENTITY MANAGEMENT / TRADEMARKS & LICENSING

For additional information and inquiries, visit edmonton.ca/visualidentity to learn about the latest updates on City's visual identity standards.

The logo for the City of Edmonton, featuring a stylized 'E' followed by the word 'Edmonton' in a sans-serif font.

City of Edmonton

VISUAL IDENTITY STANDARDS

2 FOUNDATIONAL ELEMENTS

May 2025
© City of Edmonton