



## **REDUCED OR ZERO LOT LINE SIDE YARD WALL and GABLE CONSTRUCTION Policy 14-01**

For Single Detached House and Semi-Detached House

### **INTENT:**

This policy addresses typical configurations of exterior side yard wall and side yard-facing gable construction in **Single Detached and Semi-Detached Houses** featuring reduced lot line or zero lot line (RZLL) development. To obtain building permits for construction in this setting, an alternative solution is often required as building eaves are typically proposed projecting too close to or over a side property line.

Code-compliant construction proposals in RZLL do not require alternative solution.

The policy--for the purposes of affected lot line wall construction characteristics--proposes a “deemed limiting distance”, and follows with an option for acceptable construction details for side yard wall and gable assemblies. It is not the intention that this policy limit design choices or preclude other solutions, as other options (below) are available to permit applicants.

### **POLICY:**

Where Edmonton Zoning Bylaw 12800 permits a side yard for a House to be reduced to as little as zero, resulting in non-code-compliant eave and wall construction proposals, the intent of ABC2014 is deemed to be satisfied for buildings on two adjacent lots if an imaginary “**deemed limiting distance**” line is located between the two buildings in lieu of using the legally-registered property line where

1. a valid legal agreement between adjacent owners is registered against the land titles that
  - a. establishes a permanent easement between the buildings, and
  - b. is to ensure maintenance of the spatial separation between the two buildings over time; and
2. the buildings are otherwise governed by ABC2014:B:9.10.15.

### **PROCEDURE:**

(see Notes below for additional detail)

1. The intention in application of this policy is that where the construction requirements are applied to one House sidewall, then they are to be applied to the facing assembly of the adjacent House. This policy does not apply if there is foreseeable risk that its application to adjacent property cannot be achieved, in which case a variance for each property may be required in order to obtain building permits.
2. Establish an imaginary “deemed limiting distance” line midway between the subject House and adjacent House, and apply ABC14:B:9.10.15. requirements involving:
  - a. 45-minute fire-resistance rated side yard elevations by Type X gypsum board on interior face of
    - i. exterior wood-frame walls and any pony walls,
    - ii. any floor system rim board not protected by ceiling gypsum board, and
    - iii. any side yard wall / gable end construction that encloses an attic or roof space,
  - b. non-combustible cladding -OR- vinyl siding over minimum ½” exterior grade gypsum to exterior house walls and gable ends, and
  - c. closed soffit on eave projections within 1.2m of the “deemed limiting distance”.



3. Accommodate side access to House and daylight needs where “deemed limiting distance” is less than 1.2m by constructing any combination of
  - a. DOORS, as provided in 4., below, that are
    - i. opaque standard exterior doors with **no** glazing, or
    - ii. 20-minute fire-protection rated labeled glazed door assemblies (*closures*) installed and maintained in accordance with NFPA 80 and manufacturer instructions,
  - b. WINDOWS that are
    - i. 20-minute fire-protection rated labeled window assemblies (*closures*) installed and maintained in accordance with NFPA 80 and manufacturer instructions,
    - ii. protected with 20-minute fire-protection rated labeled shutter assemblies installed and maintained in accordance with NFPA 80 and manufacturer instructions, or
    - iii. sprinkler-protected per Standata [14-BCV-018](#).
4. A side yard door and any required exterior landing and access path shall be
  - a. located only where wholly contained within the legal property boundary of the House,
  - b. arranged to not impede surface drainage or access to the side yard for each House as set down in the maintenance easement agreement,
  - c. with a landing, where required, conforming to the requirements of ABC2014:B:9.8.6., and
  - d. with an access path that leads to a public thoroughfare of minimum 1.1m width measured perpendicular from finished exterior frame wall of the House, where the door is intended to serve as the primary entrance to a secondary suite.
5. Submit the **Letter of Construction Intention**, provided near the end of this document, with the permit application. Details of this policy document shall be placed with the drawings for trades guidance.

**Notes about Procedure:**

1. If the two adjacent affected construction proposals are each, in themselves, code-compliant then there is no requirement for policy application or alternative solution.

This policy facilitates a variance for a non-compliant exposing building face per ABC2014:B:9.10.15.5. Like the registered easement agreement, this policy ties the two adjacent properties to one another in some respects. Wall construction more closely aligned with the intent of limit distance concept results where structure walls are measured to a “deemed limit distance” for purposes of wall construction intended to hinder fire spread between buildings.

2. The “deemed limit distance” then informs construction characteristics from 9.10.15.5. for
  - a. interior fire-resistance rating per Sentences (2) and (3) for limit distance <1.2m,
  - b. cladding choices per Sentence (3). Where vinyl siding is selected, fasten the required minimum ½” exterior grade gypsum sheets to the frame per ASTM C1280 (below) on the exterior side walls and any gable walls, and
  - c. soffit treatment per Sentence (10) within 1.2m of the “deemed limiting distance”.
3. Side door and window needs may be met while maintaining controls on standard glazed openings where “deemed limiting distance” <1.2m by installing *closures*, which results in “protected openings”.



*Closure* means a device or assembly for closing an opening through... an exterior wall, such as a door, a shutter, wired glass or glass block, and includes all components such as hardware, closing devices, frames and anchors. Tested *closure* assemblies are identified by a permanent label indicating the fire-protection duration, manufacturer, and so on. (Examples of some labels are shown below.)

ABC2014:B:9.10.15. addresses glazed openings (a subset of all unprotected openings) but is silent about opaque doors (opaque meaning without glazing).

- a. DOORS allows for doors, subject to minimum side yard requirements discussed in 4, below.
- i. allows for standard opaque doors with no glazing in them
  - ii. allows for glazing in doors, so long as the doors with glazing are tested and labeled as having 20-minute (1/3h) or greater fire-protection rating

*Note restriction on placement of the doors with respect to the actual legal property line; see 4, below.*

- b. WINDOWS allows for any of the following
- i. window assemblies (*closures*) with  $\geq 20$ -minute (1/3h) fire-protection rating, labeled, installed and maintained in accordance with NFPA 80 and manufacturer instructions
  - ii. shutter assemblies (*closures*) with  $\geq 20$ -minute (1/3h) fire-protection rating, labeled, installed and maintained in accordance with NFPA 80 and manufacturer instructions, to protect standard windows
  - iii. sprinkler-protected glazing installed per Standata [14-BCV-018](#)

Per 9.10.13.1, *closures* are to be tested in accordance with ABC2014:B:9.10.3.1. which directs to the test methods in Part 3--methods listed in 3.1.8.4.(1) are to the appropriate provisions of

- CAN/ULC-S104, "Fire Tests of Door Assemblies,"
- CAN4-S106-M, "Fire Tests of Window and Glass Block Assemblies," or
- CAN/ULC-S112, "Fire Test of Fire Damper Assemblies," as applicable.

Limitations on size and configurations of tested, labeled closures listed in NFPA 80 will accommodate virtually any design that might be desired in a typical RZLL location. A *closure* with a fire-protection rating exceeding 20 minutes (1/3h) is also acceptable. Hardware must be listed in accordance with NFPA 80.

Roof-mounted skylights and tubular daylighting devices are an option without requiring testing.

The following are NOT tested, labeled closures so are not acceptable without testing:

- wired glass in steel frames, as described in Article 9.10.13.5.,
- glass blocks, as described in Article 9.10.13.7., and
- metal-clad, wood-frame, triple-glazed "outside-10 window"

*Note ABC2014:B:9.36 restricts glass block assembly total aggregate area to  $\leq 1.85m^2 \sim 20 ft^2$ .*

*ABC2014:B:5.10.2.4. relaxation may be applied to fire-protection-rated closure assemblies.*



Standard glazed openings (windows) and standard glazed doors are permitted where “deemed limiting distance”  $\geq 1.2\text{m}$ . For irregular (non-parallel) stepped or skewed lots, clearly and unambiguously illustrate plans in accordance with ABC2014:B: 9.10.15.4.(2) and Appendix, consistently applying “deemed limiting distance” concept.

Mechanical penetrations for ventilation and appliance venting shall be within the respective property boundaries and in accordance with manufacturer installation instructions and [Standata G-01-10-Rev1](#)

4. Industry consultation suggests the main consideration for a side door is for secondary suite access. Most easement agreements do not provide for day-to-day use of the side yard by the owner of the reduced / zero yard; the easement is for construction, maintenance and drainage considerations. So any door is only allowed in a side yard where it and any needed landing can be accommodated without crossing property line.

FRS indicates that a 1.1m wide access path, with unlocked gate width of 0.9m, is the minimum practical clear width for all-season fire and medical emergency responder exterior access to the entrance of a secondary suite where it can not be accessed through a door inside the principal dwelling.

For more clarity, doors in a side yard are permitted only where any required landing and egress path can be established within the legal lot boundaries--**not** within “deemed limit distance” line--and its use does not involve routine use of the adjacent property.

This policy is not intended to contradict the registered easement agreement. An exterior landing must not impede surface drainage arrangements, nor access to and usefulness of the side yard to carry out maintenance and repairs of each House, as set down in the maintenance easement agreement. Any landing exceeding one riser above finished ground shall have steps arranged to allow access to the entire side yard. Minimum exterior landing dimensions are 860mm x 900mm for a secondary suite entrance.

5. The **Letter of Construction Intention** and background documentation will be managed as a Variance. In exceptional circumstances, a safety codes officer may refuse to issue a building permit that incorporates the policy; the permit applicant will be notified of reason for refusal. Non-compliance with requirements of a variance is an offence.

Policy use also achieves compliance with current requirements for Alberta Fire Code-mandated adjacent property protection (APP) under time of construction.

**Options** to construct other than in conformance with this policy include

- prescriptive compliant construction intention: design the zero limit distance House wall with no eaves, projections or any building element extending beyond a vertical plane projected from the property line, and construct it and the adjacent House in accordance with ABC14:B:9.10.15. requirements, or
- alternative solution request demonstrating a level of safety performance approximately equal or greater than acceptable solutions in ABC, (with professional engineer review of proposed wood-based wall sheathing under vinyl siding, ‘bump-in’ configuration, eave protection solutions, etc.).



**Intention** of this policy is to

- provide an acceptable RZLL side yard wall/gable wall construction solution,
- reduce the repetitive variance process paper burden for builders and City staff, and
- promote efficiencies in construction and inspections through consistency and error reduction.

*It is not the intention that this policy unduly limit design choices or preclude other solutions.*

**Information:**

**EXTRACT from ASTM C1280-13 re: EXTERIOR GYPSUM PROTECTION, FASTENING AND APPLICATION**

*Consult document for complete specifications.*

**EXTERIOR GYPSUM PROTECTION**

**Gypsum sheathing board** is a paper faced material shall be covered with a weather-resistive barrier within 30 days if 30-day exposure limit will be exceeded.

**Water-Resistant Exterior Fiber-Reinforced Gypsum Sheathing Panels** and **Glass Mat Gypsum Substrate for Use as Sheathing** each provide a substrate for exterior cladding or other weather-resistive barrier and are not intended for long-term exposure. Follow manufacturer's recommendations for maximum permissible exposure time and cover with a water- resistive barrier if that time will be exceeded.

Install any gypsum sheathing material **not less than 8" above finish grade** in weather- and water-protected siding systems and in properly drained and ventilated crawl spaces.

**FASTENING AND APPLICATION of Gypsum Panel Products**

**Screws:** C1002 for wood. **Use min 1¼" screw for ½" or ⅝" board on wood stud**

**Nails:** 12-ga galvanized, 7/16" (11mm) diameter head. **Use min 1½" for ½" board and 1¾" for ⅝" board**

- space fasteners not more than 8" o.c. along vertical ends or edges and intermediate supports
- fit snugly around all window and door openings
- offset joints minimum of 4" from the edge of any opening
- offset minimum one framing space between adjacent rows of panels
- apply 4-ft wide product either parallel or perpendicular to framing
- seal square edge panel joints where perpendicular to framing, or cover with a water-resistive barrier
- flash at openings so that water will not contact the gypsum panels



**EXAMPLE LABELS FOUND ON TESTED, APPROVED FRAMES** Metal, Mylar or, occasionally, embossed on frame  
Do not paint over the label. Glass in frame of window or door will also have label discretely affixed or etched into glass.



**Terms:**

“**Deemed limiting distance**”, for purpose of this document, means an imaginary line between two buildings on two adjacent properties where a side yard of one or both of the adjacent properties is permitted to be reduced below 1.2m to as little as zero m to property line, resulting in the two buildings being less than 2.4m apart from each other.

**ABC 2014:A:1.4.1.2. Limiting distance** means the distance from an *exposing building face* to a property line, the centre line of a *street*, lane or public thoroughfare, or to an imaginary line between 2 *buildings* or *fire compartments* on the same property, measured at right angles to the *exposing building face*.

**ABC 2014:A:1.4.1.2. Closure** means a device or assembly for closing an opening through a *fire separation* or an exterior wall, such as a door, a shutter, wired glass or glass block, and includes all components such as hardware, closing devices, frames and anchors.

**ABC 2014:A:1.4.1.2. Unprotected opening** (as applying to exposing building face) means a doorway, window or opening other than one equipped with a *closure* having the required *fire-protection rating*, or any part of a wall forming part of the *exposing building face* that has a *fire-resistance rating* less than that required for the *exposing building face*.

“**Protected opening**” is a doorway, window or opening equipped with a *closure* having the required fire-protection rating in conformance with Table 9.10.13.1 corresponding to the fire-resistance rating of the wall.

**ABC 2014:A:1.4.1.2. Fire-protection rating** means the time in minutes or hours that a *closure* will withstand the passage of flame when exposed to fire under specified conditions of test and performance criteria, or as otherwise prescribed in this Code.

*Disclaimer: The information in this policy is not intended to provide professional design advice, and may not address all conditions on a project. If professional expertise is required with respect to a specific issue or circumstance, seek professional advice and guidance.*

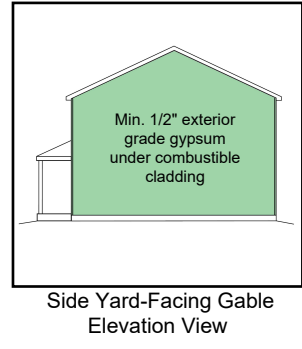
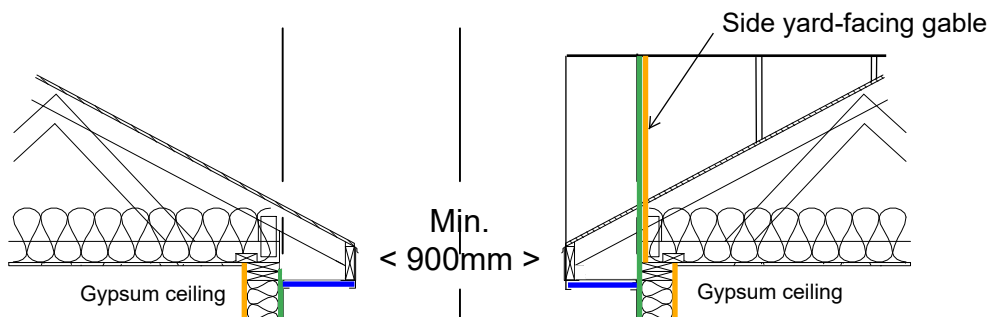

DEEMED LIMITING DISTANCE

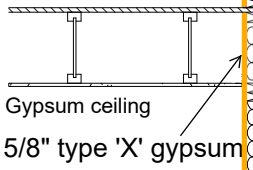
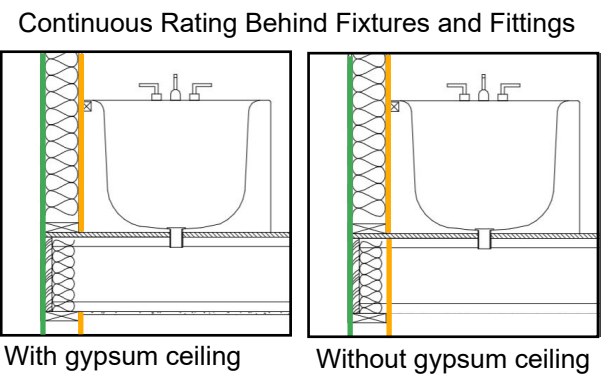

Pony wall protected w/ 5/8" type 'X' gypsum

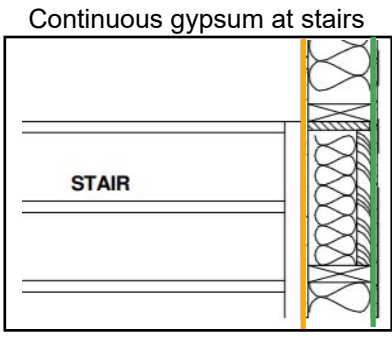

Pony wall protected w/ 5/8" type 'X' gypsum

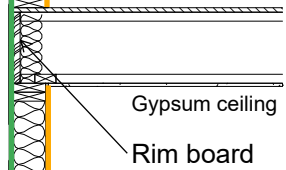
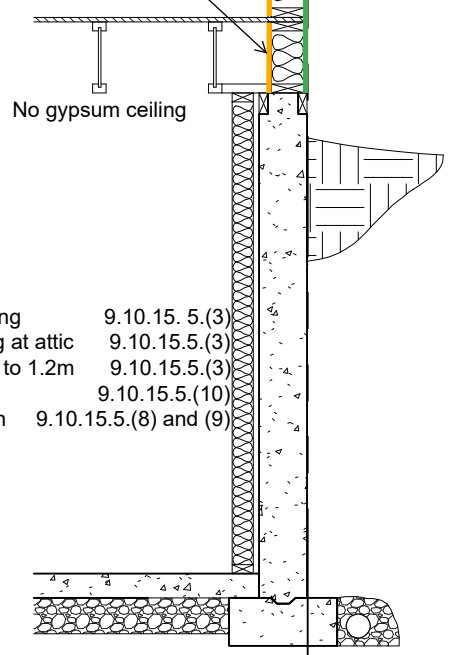

Typical Zero Lot Line Exterior Wall (inside to outside)

- 5/8" type 'X' gypsum
- Wall frame with thermal insulation
- Minimum 1/2" exterior grade gypsum
- Combustible cladding

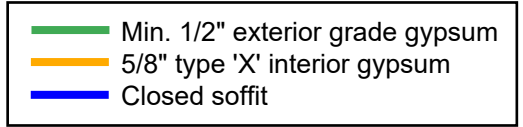
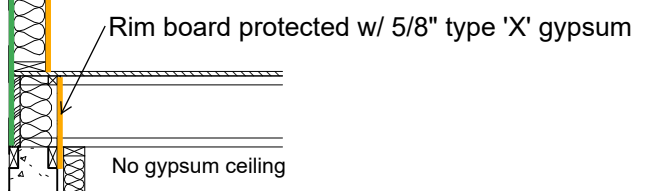

- Interior face: 3/4h fire rating 9.10.15.5.(3)
- Exterior gypsum including at attic 9.10.15.5.(3)
- Comb. cladding: 0.6m up to 1.2m 9.10.15.5.(3)
- Closed soffit 9.10.15.5.(10)
- Eave projection restriction 9.10.15.5.(8) and (9)

**Policy 14-01** 

**ZERO LOT LINE**

**Exterior Wall at Side Yard**

Does not model any air barrier, vapour barrier, thermal barrier or weather barrier

Single Detached and Semi-Detached House  
 REDUCED OR ZERO LOT LINE SIDE YARD WALL and  
 GABLE CONSTRUCTION Policy 14-01  
 Content subject to periodic update.  
 Ensure use of the most recent version. 10 January 2019



**PRINT, READ, SIGN AND SUBMIT THIS LETTER WITH THE BUILDING PERMIT APPLICATION**

Letter of Construction Intention re: Policy 14-01  
Reduced or Zero Lot Line side yard wall and gable construction  
for Single Detached and Semi-Detached Houses

TO: City of Edmonton  
Safety Codes Permits and Inspections  
3<sup>rd</sup> Floor, 10111 – 104 AVE NW  
Edmonton, AB T5J 0J4

DATE: \_\_\_\_\_

RE: PROJECT ADDRESS (or LEGAL DESCRIPTION) \_\_\_\_\_

	<b>Pre-construction Declaration--accompanies building permit application</b>
<p>1. By providing this letter, I confirm I have reviewed this ‘Reduced or Zero Lot Line Side Yard Wall and Gable Construction’ Policy 14-01.</p> <p>2. I give assurance that the side yard exterior walls and side yard gable walls that are located at the above project address will be constructed in accordance with this policy in lieu of requesting an alternative solution for a construction proposal which involves this subject property or adjacent property roof soffits projecting over a property line.</p> <p>3. I confirm that the policy document together with submitted plans, documents and details contain sufficient details to demonstrate conformance with Alberta Building Code 2014:Division C:2.2.5.2.</p> <p>4. I will notify the City of Edmonton if the approved construction intention is modified during the <i>project</i>.</p> <p>SIGNATURE OF BUILDING PERMIT APPLICANT: _____ <i>BUILDING PERMIT APPLICANT SIGNS HERE</i></p>	

**ABC2014:C:2.2.5.2. Information Required on Drawings and Specifications**

1) Information shown on drawings and in specifications shall be clear and legible, and shall contain sufficient details to demonstrate conformance with this Code. (See A-2.2.6.2.(1) in Appendix A.)

**ABC2014:C:2.2.10.9. Responsibility for Compliance**

1) Neither the issuance of a *permit* nor inspections made by the *authority having jurisdiction* shall in any way relieve the *owner* of a *building* from full responsibility for carrying out the construction or having the construction carried out in accordance with the requirements of the Safety Codes Act and regulations made pursuant to that Act, this Code, or the *permit*, including compliance with any special conditions required by the *authority having jurisdiction*.

**ABC2014:C:2.2.13.6. Verification of Compliance**

1) Except as required in Article 2.4.3.2., when required by the *authority having jurisdiction*, an *owner* or a *constructor* shall provide written assurance from the person supervising construction that the construction was in compliance with the requirements of this Code and any *permits* issued.