

THE CITY OF EDMONTON

**PROJECT AGREEMENT
VALLEY LINE WEST LRT**

Schedule 5 – D&C Performance Requirements

Part 2: Sustainable Urban Integration

TABLE OF CONTENTS

PART 2 : SUSTAINABLE URBAN INTEGRATION (SUI)	2-1
SECTION 2-1 – GENERAL SUSTAINABLE URBAN INTEGRATION REQUIREMENTS	2-1
2-1.1 Definition of Sustainable Urban Integration	2-1
2-1.2 Sustainable Urban Integration Compliance	2-1
2-1.3 Key Values.....	2-1
SECTION 2-2 – NOT USED	2-3
SECTION 2-3 – CHARACTER ZONES AND OPPORTUNITY AREAS	2-4
2-3.1 Introduction	2-4
2-3.2 West Edmonton Character Zone	2-4
2-3.3 Meadowlark Park Character Zone	2-5
2-3.4 Jasper Place Character Zone	2-6
2-3.5 Grovenor And Glenora Character Zone.....	2-7
2-3.6 Downtown Character Zone	2-8
SECTION 2-4 – URBAN REALM	2-10
2-4.1 General requirements	2-10
2-4.2 Streetscape.....	2-10
2-4.3 Crossing Treatments	2-11
2-4.4 Amenity Nodes	2-15
2-4.5 Safety Cues, Separations & Barriers	2-15
2-4.6 Crime Prevention Through Environmental Design (CPTED).....	2-22
2-4.7 Downtown Opportunity Area Special Requirements.....	2-23
2-4.8 Jasper Place Opportunity Area Special Requirements.....	2-31
SECTION 2-5 – NOT USED	2-35
SECTION 2-6 – LIGHTING	2-36
2-6.1 General	2-36
2-6.2 Right of Way Lighting.....	2-36
2-6.3 Facility Lighting	2-37
2-6.4 WEM Transit Centre and Lewis Farms Park and Ride Lighting	2-38
SECTION 2-7 – PUBLIC ART	2-39
SECTION 2-8 – BRANDING	2-45
SECTION 2-9 – SUPPORT SYSTEMS	2-46
2-9.1 General	2-46
2-9.2 Electrical Boxes	2-46
2-9.3 Conduit and Cables	2-46
2-9.4 Wayside Equipment Enclosures	2-46

2-9.5	Duct Banks	2-46
2-9.6	Drainage	2-46
2-9.7	Standpipes	2-47
2-9.8	Overhead Catenary System	2-47
2-9.9	Utility Complexes	2-52
2-9.10	Vehicle Arrestors	2-53
SECTION 2-10 – STOPS AND STATIONS		2-54
2-10.1	Introduction	2-54
2-10.2	General Stop and Station Integration	2-54
2-10.3	Stop and Station Specific Requirements	2-58
SECTION 2-11 – STRUCTURES		2-72
2-11.1	General	2-72
2-11.2	87 Avenue Elevated Guideway	2-75
2-11.3	Anthony Henday Drive LRT Bridge	2-81
2-11.4	Stony Plain Road Bridge	2-82
2-11.5	Walls	2-83
SECTION 2-12 – WEM TRANSIT CENTRE		2-86
2-12.1	General	2-86
2-12.2	Transit Shelters and Seating	2-86
2-12.3	Clock Tower	2-86
SECTION 2-13 – MAINTENANCE AND STORAGE FACILITIES		2-88
2-13.1	Gerry Wright OMF	2-88
2-13.2	Lewis Farms Storage Facility	2-89
SECTION 2-14 – LANDSCAPE ARCHITECTURE		2-91
2-14.1	General	2-91
2-14.2	Landscape Architecture Design Standards	2-91
2-14.3	Sustainability	2-91
2-14.4	Landscaped Areas	2-92
2-14.5	Required Planting Setbacks	2-97
2-14.6	West Edmonton Character Zone Landscape Requirements	2-97
2-14.7	Meadowlark Park Character Zone Landscape Requirements	2-111
2-14.8	Jasper Place Character Zone Landscape Requirements	2-115
2-14.9	Grovenor and Glenora Character Zone Landscape Requirements	2-116
2-14.10	Downtown Character Zone Landscape Requirements	2-129
2-14.11	Gerry Wright OMF Parcel B Landscaping	2-135
2-14.12	Utility Complex Site Landscaping	2-135
2-14.13	Existing Stormwater Management Facilities Landscape Requirements	2-139

2-14.14	Isolated Landscape Disturbance	2-139
2-14.15	Tree Retention, Removal, and Protection.....	2-139
2-14.16	Low Impact Development Facilities	2-148
2-14.17	Landscape Sub-Drainage System	2-148
2-14.18	Structural Soil Cells	2-148
2-14.19	Tree Grates.....	2-149
2-14.20	Verges	2-149
2-14.21	Topsoil and LID Soils.....	2-149
2-14.22	Wood Bumper Posts.....	2-150
2-14.23	Irrigation.....	2-150
2-14.24	Shrub Beds.....	2-150
2-14.25	Weed Barrier Fabric.....	2-150
2-14.26	Tree Root Barrier	2-150
2-14.27	Boulders.....	2-151
2-14.28	Mulches	2-151
2-14.29	Plant Material.....	2-151
SECTION 2-15 - LANDSCAPE ESTABLISHMENT		2-162

TABLES AND FIGURES

FIGURE 2-4.3.1: CROSSING TREATMENT, TYPICAL CENTRE PLATFORM STOP	2-13
FIGURE 2-4.3.2: CROSSING TREATMENT, TYPICAL SIDE-LOADING PLATFORM STOPS WITH ROADWAY ON BOTH SIDES	2-13
FIGURE 2-4.3.3: CROSSING TREATMENT, TYPICAL SIDE-LOADING PLATFORM STOP BETWEEN LANDSCAPE AREA AND ROADWAY	2-14
FIGURE 2-4.3.4: CROSSING TREATMENT, DOWNTOWN OPPORTUNITY AREA STOP BETWEEN LANDSCAPE AREA AND ROADWAY	2-14
TABLE 2-4.5.1: SAFETY CUES, SEPARATIONS AND BARRIERS	2-15
TABLE 2-4.5.3.1: PROTECTION RAILINGS	2-18
FIGURE 2-4.5.3.3: LRV BARRIER.....	2-21
FIGURE 2-4.7.1-1: CYCLE TRACK PAINT MARKINGS – HIGH LEVEL CONFLICT ZONE	2-24
FIGURE 2-4.7.1-2: TACTILE WARNING SURFACE INDICATOR LAYOUT, FULL RADIUS CURB RAMP	2-25
FIGURE 2-4.7.2: TACTILE WARNING SURFACE INDICATOR LAYOUT, MID-BLOCK CROSSING.....	2-26
FIGURE 2-4.7.3: TACTILE WARNING SURFACE INDICATOR LAYOUT, SEPARATE CURB RAMPS.....	2-27
FIGURE 2-4.7.4: TACTILE WARNING SURFACE INDICATOR ORIENTATION, OFFSET INTERSECTION	2-27

TABLE 2-6.3: MAINTAINED HORIZONTAL ILLUMINANCE LEVELS FOR INTERIOR SPACES AT STATIONS	2-38
TABLE 2-7: PUBLIC ART	2-39
TABLE 2-9.8: OCS POLE REQUIREMENTS	2-49
FIGURE 2-9.8: OCS POLE ARCHITECTURAL FEATURES	2-51
TABLE 2-10.2.3: STOP PI THEME AND CANOPY TYPE FOR EACH STOP AND STATION	2-55
FIGURE 2-10.2.3: STOP CANOPIES	2-56
FIGURE 2-10.3.5A: FUTURE ENCLOSED GRADE-SEPARATED PEDESTRIAN WALKWAY	2-60
FIGURE 2-10.3.5B: WEM STATION PLATFORM CURVATURE	2-61
FIGURE 2-10.3.5C: WEM STATION CANOPY: CROSS SECTION	2-62
FIGURE 2-10.3.5D: WEM STATION CANOPY: LONGITUDINAL SECTION	2-62
FIGURE 2-10.3.5E: WEM STATION FLOATING TIMBER ROOF DECK	2-63
FIGURE 2-10.3.5F: WEM STATION CEILINGS	2-64
FIGURE 2-10.3.5G: WEM STATION SOFFITS – SECTION VIEW	2-65
FIGURE 2-10.3.5H: WEM STATION SOFFITS – AXONOMETRIC VIEW	2-65
FIGURE 2-10.3.5I: WEM STATION EMERGENCY GENERATOR LOCATION	2-66
FIGURE 2-10.3.6A: MISERICORDIA STATION CANOPY – SECTION AT VERTICAL CIRCULATION	2-67
FIGURE 2-10.3.6B: MISERICORDIA STATION CANOPY – SECTION OUTSIDE OF VERTICAL CIRCULATION	2-68
FIGURE 2-10.3.6C: MISERICORDIA STATION TIMBER ROOF DECK	2-69
FIGURE 2-10.3.6D: MISERICORDIA STATION CEILINGS	2-69
FIGURE 2-10.3.6E: MISERICORDIA STATION SOFFITS – AXONOMETRIC VIEW	2-70
FIGURE 2-10.3.6F: MISERICORDIA STATION EMERGENCY GENERATOR LOCATION	2-71
FIGURE 2-11.2A: 87 AVENUE ELEVATED GUIDEWAY SECTION – BOX GIRDER (DIMENSIONS IN MM)	2-76
FIGURE 2-11.2B: 87 AVENUE ELEVATED GUIDEWAY SECTION – TROUGH GIRDER (DIMENSIONS IN MM)	2-77
FIGURE 2-11.2C: 87 AVENUE ELEVATED GUIDEWAY ELEVATION – VARIABLE-DEPTH GIRDER (DIMENSIONS IN MM)	2-78
FIGURE 2-11.2D: 87 AVENUE ELEVATED GUIDEWAY RAMP PARTIAL SECTION - BOX GIRDER	2-80
FIGURE 2-11.2E: 87 AVENUE ELEVATED GUIDEWAY RAMP PARTIAL SECTION - TROUGH GIRDER	2-81
FIGURE 2-11.4: STONY PLAIN ROAD BRIDGE SYMMETRIC OVERHANG FROM EXTERIOR GIRDERS	2-83

FIGURE 2-11.5.2A: STEPPED WALLS	2-84
FIGURE 2-13.2: LEWIS FARMS STORAGE FACILITY DIMENSION REQUIREMENTS	2-90
FIGURE 2-14.4.1: ILLUSTRATED LANDSCAPED AREA DEFINITIONS.....	2-92
TABLE 2-14.4.2: SPATIAL REQUIREMENTS FOR PLANTING	2-93
TABLE 2-14.5: TREE SETBACKS.....	2-97
TABLE 2-14.8.1.3: JASPER PLACE OPPORTUNITY AREA PLANT LIST.....	2-116
TABLE 2-14.10.2.3: 107 STREET STREETScape PLANT LIST.....	2-132
TABLE 2-14.10.3.3: ALEX DECOTEAU PARK PLANT LIST	2-133
TABLE 2-14.10.4.3: 102 AVENUE STREETScape PLANT LIST	2-134
TABLE 2-14.12.4: UTILITY COMPLEX LANDSCAPING REQUIREMENTS	2-137
FIGURE 2-14.15.4: CRITICAL ROOT ZONES	2-142
TABLE 2-14.29.3: TREE SPECIES FOR LANDSCAPING	2-152
FIGURE 2-14.29.4: STREET TREE SPECIES DIVERSITY	2-154
TABLE 2-14.29.5.1: TREE SPECIES FOR STORMWATER MANAGEMENT FACILITIES	2-154
TABLE 2-14.29.5.2: SHRUB AND PERENNIAL SPECIES FOR STORMWATER MANAGEMENT FACILITIES	2-154
TABLE 2-14.29.6: SHRUB AND PERENNIAL SPECIES FOR LANDSCAPE AREAS.....	2-155
TABLE 2-14.29.10: PERENNIAL SPECIES FOR ROADWAY BOULEVARD LANDSCAPE AREAS, TRACKWAY BOULEVARD LANDSCAPE AREAS AND ROADWAY MEDIAN LANDSCAPE AREAS.....	2-160

APPENDICES

APPENDIX 5-2A - 102 AVENUE – 107 STREET STREETScape DRAWINGS

APPENDIX 5-2B - JASPER PLACE OPPORTUNITY AREA STREETScape

APPENDIX 5-2C - UNDER GUIDEWAY LANDSCAPE AREA

PART 2: SUSTAINABLE URBAN INTEGRATION (SUI)

Section 2-1– GENERAL SUSTAINABLE URBAN INTEGRATION REQUIREMENTS

2-1.1 DEFINITION OF SUSTAINABLE URBAN INTEGRATION

- A. Sustainable Urban Integration (SUI) means a focus on the mutually-supportive integration of the Infrastructure into the urban context within which it exists.
- B. SUI requirements shall be reflected in all aspects of the Design and Construction of the Infrastructure and together provide a high quality, fully accessible, safe, efficient, visually integrated, and environmentally sustainable transportation network that:
 - 1. maximizes Passengers' convenience;
 - 2. supports the City's continuing economic prosperity;
 - 3. serves and in turn is served by transit-oriented land use policies; and
 - 4. is consistent with the City Vision and Strategic Plan, as well as City Plans, including "The Way We Grow", "The Way We Green", and "The Way We Move".
- C. A key SUI goal is to promote a range of planning and design opportunities that will support the overall sustainability and resilience of the City. The low-floor, urban-style LRT system has been selected to support an integrated approach to urban and sustainable planning, while recognizing the importance and value of creating vital, diverse, and pedestrian friendly environments with a strong sense of place.

2-1.2 SUSTAINABLE URBAN INTEGRATION COMPLIANCE

- A. Without limiting the requirements of this Part 2 [*Sustainable Urban Integration*], the Design and Construction of the Infrastructure shall be consistent with the themes, colours, imagery and aesthetics illustrated in the Valley Line West LRT Design Guide.
- B. Unless specifically indicated otherwise, all Building Structures materials, components and equipment described in this Part 2 [*Sustainable Urban Integration*] of this Schedule shall comply with the Valley Line West LRT Facilities Design and Construction Standards.

2-1.3 KEY VALUES

- A. Design and Construction of the Infrastructure shall ensure that the following key values are met:
 - 1. Pedestrians First: Apply a 'Pedestrians First' approach that is safe, facilitates convenient access to the Infrastructure, and creates a vibrant public realm.
 - 2. Sustainable: Conserve and connect to the City parks within the Lands, support the City's goals of sustainability and resilience as set out in the City's environmental strategic plan "The Way We Green", and integrate sustainable technologies and materials wherever possible.
 - 3. Flexible and Adaptable: Incorporate design elements and systems that are flexible, adaptable, and capable of responding to future conditions.
 - 4. Integrated:
 - a. Integrate the Infrastructure into the existing environment, infrastructure and Valley Line LRT Stage 1 using a holistic approach across all design disciplines.
 - b. Optimize the user experience and integrate into the urban context, such that each component presents a positive contribution to the built environment for the Infrastructure's users, neighbours, and passersby.

- c. Given that each SUI component is located within a unique neighbourhood context, design each component to respond to its context and incorporate the Character Zone and Opportunity Area the component is located in.
- d. Minimize visible elements to achieve a coherent and uncluttered appearance through the integration of systems such as street lighting, OCS and Traffic Signals, signage, and Passenger Interface Equipment

Section 2-2 – NOT USED

Section 2-3– CHARACTER ZONES AND OPPORTUNITY AREAS

2-3.1 INTRODUCTION

- A. The urban look and feel of the areas through which the Infrastructure passes has been classified into five distinct Character Zones. Each Character Zone has unique hardscapes and softscapes, history, cultural influences, and community connections, which are to be reflected and incorporated into the Design and Construction of the Infrastructure components located within the relevant Character Zone.
- B. A Character Zone is further divided into one or more Opportunity Areas. Individual components of the Infrastructure shall respond to the context of the Opportunity Area and shall be uniform within an Opportunity Area.
- C. This Section 2-3 [*Character Zones and Opportunity Areas*] outlines the Character Zones and sets out general requirements for each Opportunity Area. These general requirements are complemented with more specific requirements throughout this Part 2 [*Sustainable Urban Integration*] and other Parts of this Schedule.
- D. In addition to responding to the Character Zone and Opportunity Area, specified components at Stops and Stations are also required to reflect specific themes established during the Public Involvement process (“**Stop PI Theme**”). The Stop PI Themes are outlined in Section 2-10.2 [*General Stop and Station Integration*] of this Schedule and illustrated in the Valley Line West LRT Design Guide.

2-3.2 WEST EDMONTON CHARACTER ZONE

- A. The West Edmonton Character Zone extends from the Project limit west of the Lewis Farms Park and Ride to the intersection of 87 Avenue and 161 Street.
- B. The West Edmonton Character Zone shall strengthen established commercial assets with additional pedestrian connectivity to existing destinations and new, higher density mixed-use developments along 87 Avenue.
- C. There are three (3) Opportunity Areas within the West Edmonton Character Zone:
 - 1. Lewis Farms Opportunity Area, as set out in Section 2-3.2.1 [*Lewis Farms Opportunity Area*] of this Schedule;
 - 2. West Edmonton Mall Opportunity Area, as set out in Section 2-3.2.2 [*West Edmonton Mall Opportunity Area*] of this Schedule; and
 - 3. Misericordia Opportunity Area, as set out in Section 2-3.2.3 [*Misericordia Opportunity Area*] of this Schedule.

2-3.2.1 Lewis Farms Opportunity Area

- A. The Lewis Farms Opportunity Area extends from the Project limit at the west side of the Lewis Farms Park and Ride to Aldergrove Park.
- B. Project Co’s Design of the Lewis Farms Opportunity Area shall:
 - 1. include a Pedestrian Priority Zone (PPZ, see Section 2-4.2 [*Streetscape*] of this Schedule) within the Lewis Farms Park and Ride for Passengers changing modes. The PPZ shall be designed and constructed to reflect the Character Zone’s natural and open spaces with direct pedestrian connections to surrounding neighbourhoods, recreational areas, sidewalks, SUPs, and amenity spaces. The Lewis Farms Park and Ride, including the Lewis Farms Storage Facility, shall be screened from the surrounding natural areas by landscaping;
 - 2. include a PPZ at the intersection of Webber Greens Drive and the Lewis Farms Transit Centre entrance to increase connectivity to the adjacent retail centres;

3. enhance and expand the existing SUP to connect the Lewis Farms Transit Centre and Lewis Farms Stop to the Aldergrove/Belmead Stop;
4. include new boulevards and medians with a combination of trees, shrubs, and sod to contribute to the park like setting of the Character Zone; and
5. include a PPZ at the Aldergrove/Belmead Stop.

2-3.2.2 West Edmonton Mall Opportunity Area

- A. The West Edmonton Mall Opportunity Area extends along 87 Avenue from Aldergrove Park to 170 Street. The Trackway in this Opportunity Area is elevated.
- B. Project Co's Design of the West Edmonton Mall Opportunity Area shall:
 1. include a PPZ at the WEM Station and WEM Transit Centre that includes the adjacent 87 Avenue intersections to the east and west to improve pedestrian connections to these facilities;
 2. establish SUPs or sidewalks along both sides of 87 Avenue; and
 3. incorporate an appealing and inviting streetscape below the 87 Avenue Elevated Guideway where it extends adjacent to a pedestrian pathway.

2-3.2.3 Misericordia Opportunity Area

- A. The Misericordia Opportunity Area extends along 87 Avenue from 170 Street to 161 Street. The Trackway in this Opportunity Area is elevated.
- B. Project Co's Design of the Misericordia Opportunity Area shall:
 1. include a PPZ at the Misericordia Station that includes the intersections of 87 Avenue and 169 Street and 87 Avenue and 165 Street to improve pedestrian connections to the surrounding area;
 2. establish a SUP along the north side of 87 Avenue between 170 Street and 165 Street;
 3. establish a sidewalk along the south side of 87 Avenue between 170 Street and 165 Street;
 4. establish sidewalks along both sides of 87 between 165 Street and 161 Street; and
 5. incorporate an appealing and inviting streetscape below the 87 Avenue Elevated Guideway where it extends adjacent to a pedestrian pathway.

2-3.3 MEADOWLARK PARK CHARACTER ZONE

- A. The Meadowlark Park Character Zone extends from 161 Street on 87 Avenue to 100 Avenue on 156 Street.
- B. Project Co's Design of the Meadowlark Park Character Zone shall leverage the LRT Corridor to support existing stable residential and commercial developments while also encouraging transformation into an area of higher intensification.
- C. There are two (2) Opportunity Areas within the Meadowlark Park Character Zone:
 1. Meadowlark Opportunity Area, as set out in Section 2-3.3.1 [*Meadowlark Opportunity Area*] of this Schedule; and
 2. 156 Street Opportunity Area, as set out in Section 2-3.3.2 [*156 Street Opportunity Area*] of this Schedule.

2-3.3.1 Meadowlark Opportunity Area

- A. The Meadowlark Opportunity Area extends from 161 Street on 87 Avenue to 90 Avenue on Meadowlark Road.
- B. Project Co's Design of the Meadowlark Opportunity Area shall:
 - 1. include a PPZ at the intersection of Meadowlark Road and 87 Avenue and improve pedestrian connectivity for the adjacent seniors housing complex;
 - 2. include a PPZ at the Meadowlark Stop that supports increased pedestrian access between the retail and residential community by increasing the number of pedestrian connections between the east and west side of Meadowlark Road; and
 - 3. provide a streetscape that encourages future intensification and/or Transit Oriented Development surrounding the Meadowlark Stop.

2-3.3.2 156 Street Opportunity Area

- A. The 156 Street Opportunity Area extends along 156 Street from 90 Avenue to 100 Avenue.
- B. Project Co's Design of the 156 Street Opportunity Area shall:
 - 1. include a PPZ at the Glenwood/Sherwood Stop that supports access from the surrounding retail and residential community and encourages future infill development of surrounding sites; and
 - 2. provide a streetscape that prioritizes treed boulevards except where parking lanes are required in accordance with Section 3-2.11 [*Area Specific Requirements*] of this Schedule.

2-3.4 JASPER PLACE CHARACTER ZONE

- A. The Jasper Place Character Zone extends from the north curb returns of 100 Avenue on 156 Street to 149 Street on Stony Plain Road.
- B. The Jasper Place Character Zone shall leverage the LRT Corridor to support existing stable residential developments while also transforming into an area of higher intensification with a mixing of uses. The pedestrian realm shall be activated to reinforce local community interaction.
- C. There is one (1) Opportunity Area within the Jasper Place Character Zone:
 - 1. Jasper Place Opportunity Area, as set out in Section 2-3.4.1 [*Jasper Place Opportunity Area*] of this Schedule.

2-3.4.1 Jasper Place Opportunity Area

- A. The Jasper Place Opportunity Area extends from 100 Avenue on 156 Street to 149 Street on Stony Plain Road.
- B. Project Co's Design of the Jasper Place Opportunity Area shall:
 - 1. include a PPZ extending to the limits of this Opportunity Area;
 - 2. maintain or restore the existing Stony Plain Road design themes and streetscape between 149 Street and 156 Street to:
 - a. support the existing Jasper Place Area Redevelopment Plan; and
 - b. support pedestrian access from the surrounding retail and residential community and encourage pedestrian oriented uses and frontage conditions (e.g. café spill out);

3. extend the design themes and streetscape that currently exist on Stony Plain Road between 149 Street to 156 Street onto 156 Street up to the north curb returns on 100 Avenue;
4. incorporate a shared-use corridor on 100A Avenue between the Jasper Place Stop and the east edge of the existing Jasper Place Transit Centre that shall:
 - a. support safe pedestrian connectivity between the two transit modes;
 - b. utilize similar design themes and streetscape that currently exist on Stony Plain Road between 149 Street and 156 Street; and
 - c. be designed as a PPZ;
5. encourage future intensification and/or Transit Oriented Development surrounding the Jasper Place Stop.

2-3.5 GROVENOR AND GLENORA CHARACTER ZONE

- A. The Grovenor and Glenora Character Zone extends from 149 Street on Stony Plain Road to 121 Street on 104 Avenue.
- B. The Grovenor and Glenora Character Zone shall reinforce the early 20th century character of the neighbourhoods while evolving to provide a greater range of community and Transit Oriented Developments adjacent to the LRT corridor.
- C. There are two (2) Opportunity Areas within the Grovenor and Glenora Character Zone:
 1. Grovenor Opportunity Area, as set out in Section 2-3.5.1 [*Grovenor Opportunity Area*] of this Schedule.
 2. Westmount Opportunity Area, as set out in Section 2-3.5.2 [*Westmount Opportunity Area*] of this Schedule.

2-3.5.1 Grovenor Opportunity Area

- A. The Grovenor Opportunity Area extends along Stony Plain Road from 149 Street to the Stony Plain Road Bridge.
- B. Project Co's Design of the Grovenor Opportunity Area shall:
 1. include a PPZ surrounding the Grovenor/142 St. Stop and the adjacent intersections along Stony Plain Road (from 139 Street to 144 Street) to promote connectivity to the surrounding community and existing/future Transit Oriented Development;
 2. provide a streetscape at the Grovenor/142 St. Stop that integrates with the adjacent mixed-use development site;
 3. include a PPZ at the Glenora Stop;
 4. incorporate an enhanced amenity pocket park on the northwest side of Stony Plain Road and 134 Street; and
 5. incorporate a SUP on the south side of the Stony Plain Road Bridge.

2-3.5.2 Westmount Opportunity Area

- A. The Westmount Opportunity Area extends from the Stony Plain Road Bridge to 121 Street on 104 Avenue.
- B. Project Co's Design of the Westmount Opportunity Area shall:

1. include a PPZ at the intersection of Stony Plain Road and 127 Street to help facilitate cyclist crossings of Stony Plain Road;
2. include a PPZ at the 124 Street Stop that extends from 125 Street to the east end of the Opportunity Area to prioritize pedestrian connectivity to the surrounding retail and residential community;
3. establish a SUP along the south side of Stony Plain Road between Connaught Drive and 127 Street; and
4. provide a streetscape that encourages future intensification in the area.

2-3.6 DOWNTOWN CHARACTER ZONE

- A. The Downtown Character Zone extends from 121 Street on 104 Avenue to the Project limit on 102 Avenue.
- B. The Downtown Character Zone shall leverage the introduction of the Infrastructure to support a range of future redevelopment opportunities, particularly at large surface parking lots and other underutilized lots, while increasing pedestrian accessibility to, and connectivity between, a range of community amenities such as parks, post secondary institutions and retail destinations. The design of the Infrastructure within this Character Zone shall preserve and enhance the existing heritage and community character. Landscaping shall introduce new Street Trees, rather than planting beds.
- C. There are two (2) Opportunity Areas within the Downtown Character Zone:
 1. 104 Avenue Opportunity Area, as set out in Section 2-3.6.1 [*104 Avenue Opportunity Area*] of this Schedule.
 2. Downtown Opportunity Area, as set out in Section 2-3.6.2 [*Downtown Opportunity Area*] of this Schedule.

2-3.6.1 104 Avenue Opportunity Area

- A. The 104 Avenue Opportunity Area extends along 104 Avenue from 121 Street to 107 Street.
- B. Project Co's Design of the 104 Avenue Opportunity Area shall:
 1. support the 104 Avenue Area Redevelopment Plan within the LRT Corridor;
 2. consist of a PPZ throughout the Opportunity Area to support increased pedestrian activity;
 3. increase the number of pedestrian connections between the north and south side of 104 Avenue;
 4. maintain the existing pedestrian and bicycle crossings across 104 Avenue at 110 Street to connect the bike network along 105 Avenue to the SUP along 110 Street south of 104 Avenue; and
 5. provide a pedestrian friendly streetscape to encourage future redevelopment and/or Transit Oriented Development in the area.

2-3.6.2 Downtown Opportunity Area

- A. The Downtown Opportunity Area extends from 107 Street on 104 Avenue to the Project limit on 102 Avenue.
- B. Project Co's design of the Downtown Opportunity Area shall:
 1. support the framework established in the *Downtown and Quarters Streetscape Design Manual*;

2. include a PPZ throughout the Opportunity Area to support increased pedestrian activity;
3. include separated bicycle lanes along 102 Avenue to integrate with the downtown bike network;
and
4. provide an enhanced streetscape to create a strong pedestrian corridor.

Section 2-4 – URBAN REALM

- A. This Section 2-4 [*Urban Realm*] sets out the urban realm requirements, which shall be incorporated into the Design and Construction of the Infrastructure.

2-4.1 GENERAL REQUIREMENTS

- A. The Infrastructure shall provide continuity of identity throughout the Lands and shall be consistent with the:
1. City of Edmonton Transit Oriented Development Guidelines;
 2. City of Edmonton ETS Transit Centre Design Guidelines;
 3. Valley Line West LRT Facilities Design and Construction Standards;
 4. Valley Line West LRT Roadways Design and Construction Standards;
 5. Valley Line West LRT Landscape Design and Construction Standards;
 6. Design Guide for a Safer City;
 7. Jasper Place Area Redevelopment Plan;
 8. 104 Avenue Corridor Area Redevelopment Plan;
 9. City of Edmonton Downtown and the Quarters Downtown Streetscape Design Manual;
 10. City of Edmonton Main Streets Guideline;
 11. the Lewis Farms Area Structure Plan;
 12. Potter Greens Neighbourhood Structure Plan (NSP); and
 13. any other area and station area redevelopment plan within or adjacent to the Lands.

2-4.2 STREETSCAPE

- A. A streetscape includes all elements that constitute the cross-section of a street within the Right of Way, including landscaping, boulevards, Roadways, medians, sidewalks and SUPs.
- B. Pedestrian Priority Zones (PPZs) are delineated areas along the LRT Corridor where safe and comfortable pedestrian movement is intended to be prioritized.
- C. Provide a PPZ at the locations, and with the extents, shown in the Valley Line West LRT Design Guide. Within each PPZ:
1. landscaping shall be as set out in Section 2-14 [*Landscape Architecture*] of this Schedule;
 2. lighting shall be as set out in Section 2-6.2K [*Right of Way Lighting*] of this Schedule;
 3. Except as otherwise noted in Section 2-4.7 [*Downtown Opportunity Area Special Requirements*] and Section 2-4.8 [*Jasper Place Opportunity Area Special Requirements*] of this Schedule, Platforms at all Stops, including all curbs and housekeeping pads, shall be cast-in-place Integrally Coloured Concrete reasonably matching the Interstar Ready Mix Goldenrod, J0-7960R (1 bag), and shall be broom finished with sawcut scoring; and
 4. Platforms and pedestrian Track crossings in the Stations shall be naturally coloured cast-in-place concrete, with broom finish and sawcut scoring. The sawcut scoring pattern shall align with the arch ribs, mullions and other vertical features such as doors.

- D. Pedestrian pathways and Transit Centre platforms within the WEM Site and the pedestrian pathways within the Misericordia Site shall conform to the drawings in Appendix 5-2C [*Under Guideway Landscape Area Drawings*] of this Schedule and to the Valley Line West LRT Design Guide.
- E. The following sections of Embedded Trackway slabs (including the concrete infill strip between the Tracks) shall be cast-in-place Integrally Coloured Concrete reasonably matching the mixes noted:
 - 1. Interstar Ready Mix Black Onyx, NR-5790R (2 bags), with sawcut and broom finish between the eastern Project limit to the intersection of 107 Street and 104 Avenue; and
 - 2. Interstar Ready Mix Plum, BN-1616R (1 bag), with sawcut and broom finish from the intersection of 107 Street and 104 Avenue to the east approach of the 87 Avenue Elevated Guideway Ramp.
- F. All exposed to Public View concrete surfaces of Embedded Trackway slabs which are the same colour shall be uniform in colour.
- G. Sidewalks shall comply with the requirements in Section 3-2 [*Roadways, Sidewalks and Shared Use Paths*] of this Schedule.
- H. Integrally Coloured Concrete samples of Interstar Ready Mix Plum, Black Onyx and Goldenrod can be provided by the City upon request.

2-4.3 CROSSING TREATMENTS

- A. Provide refuge areas at the base of all Platform Access Points as shown in Figures 2-4.3.1 [*Crossing Treatment, Typical Centre Platform Stop*] to Figure 2-4.3.4 [*Crossing Treatment, Downtown Opportunity Area Stop Between Landscape Area and Roadway*] and as follows:
 - 1. provide bollards to create a pedestrian refuge area, arranged nominally as shown and as further set out in Section 2-4.5.2 [*Visual, Auditory and Tactile Cues*] of this Schedule. Bollards shall:
 - a. be Reliance Foundry R-8464-RA, coated black (colour code RAL 9011), or alternate acceptable to the City;
 - b. be 900 mm high;
 - c. include lockable and removable bases with inner covers; and
 - d. be visible at night through incorporation of reflective stripping;
 - 2. provide tactile attention indicators for all Track and Roadway crossings as follows:
 - a. extend the same tactile attention indicator used on the Platforms down from the Platform edge to the inside edge of the white coloured concrete edge of the pedestrian crossing furthest from the Platform for all Track crossings; and
 - b. provide the same tactile attention indicator used on the Platforms from the inside edge of the white coloured concrete edge closest to the Platform to the inside edge of the white coloured concrete edge of the pedestrian crossing further from the Platform for all Roadway crossings; and
 - 3. provide broom-finished or troweled cast-in-place concrete, matching the colour of the Platform concrete of the nearest Stop, from the Platform Access Points to the refuge areas and associated crosswalks to provide continuity of surface finish from the Stop Platform to the pedestrian crossings.

- B. Provide treatments of crosswalks within PPZs, except for the crosswalks extending across 149 Street and the crosswalks within the WEM Transit Centre and the Lewis Farms Park and Ride, as follows:
1. provide at both edges of the crosswalk and at edges of refuge areas that are not intended to be crossed by pedestrians a white concrete edge strip, using exclusively white cement for all cementitious materials or other means acceptable to the City to provide “white” concrete, having the same width as the tactile attention indicator used at the associated Platform; and
 2. between the white concrete edges, provide cast-in-place broom-finished or troweled Integrally Coloured Concrete, matching the colour of the Stop Platform concrete.



Figure 2-4.3.1: Crossing Treatment, Typical Centre Platform Stop

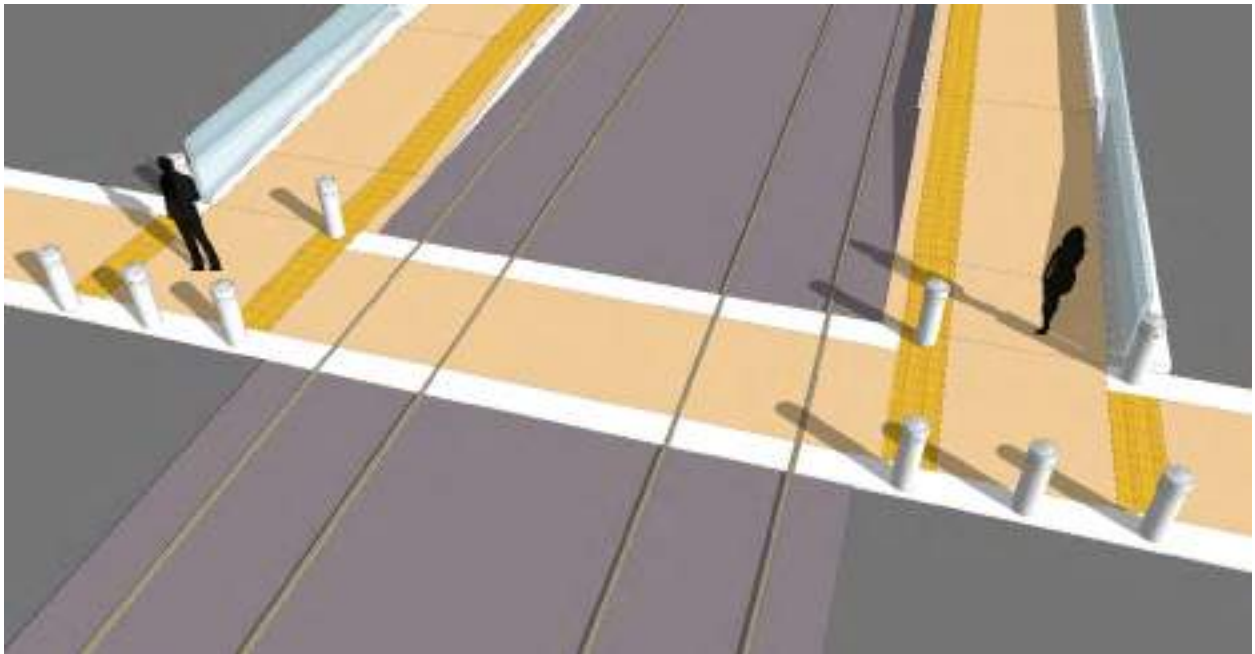

Figure 2-4.3.2: Crossing Treatment, Typical Side-Loading Platform Stops with Roadway on Both Sides

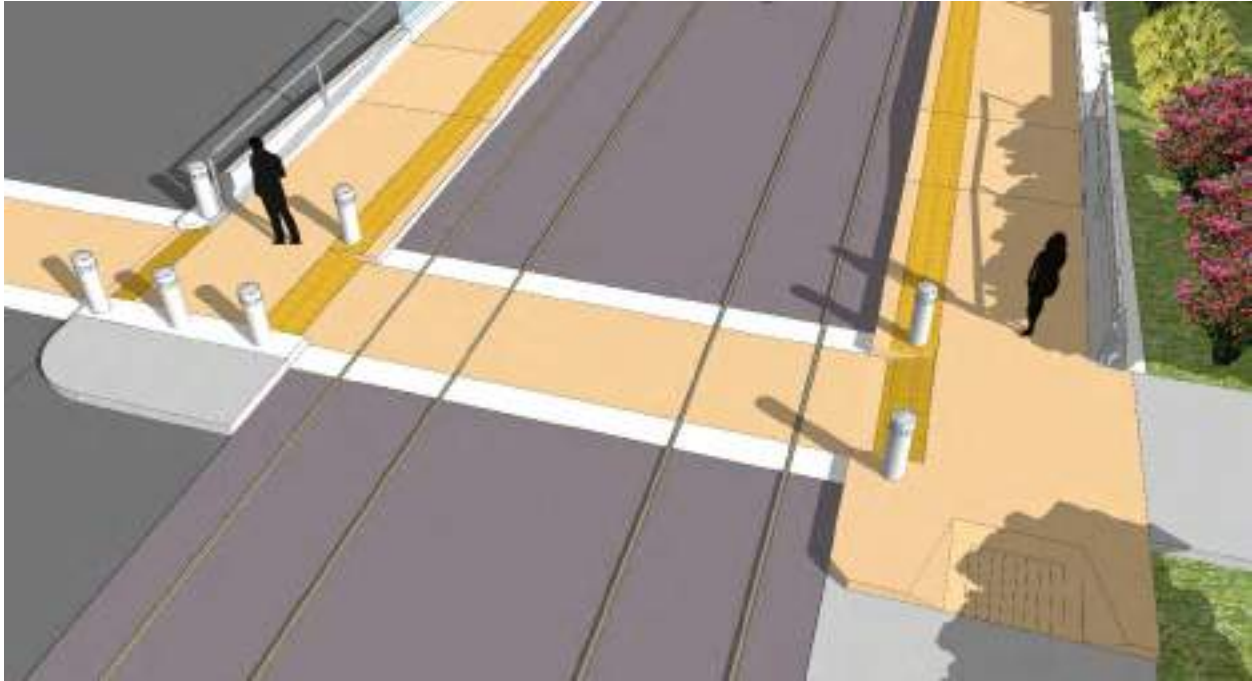

Figure 2-4.3.3: Crossing Treatment, Typical Side-Loading Platform Stop Between Landscape Area and Roadway

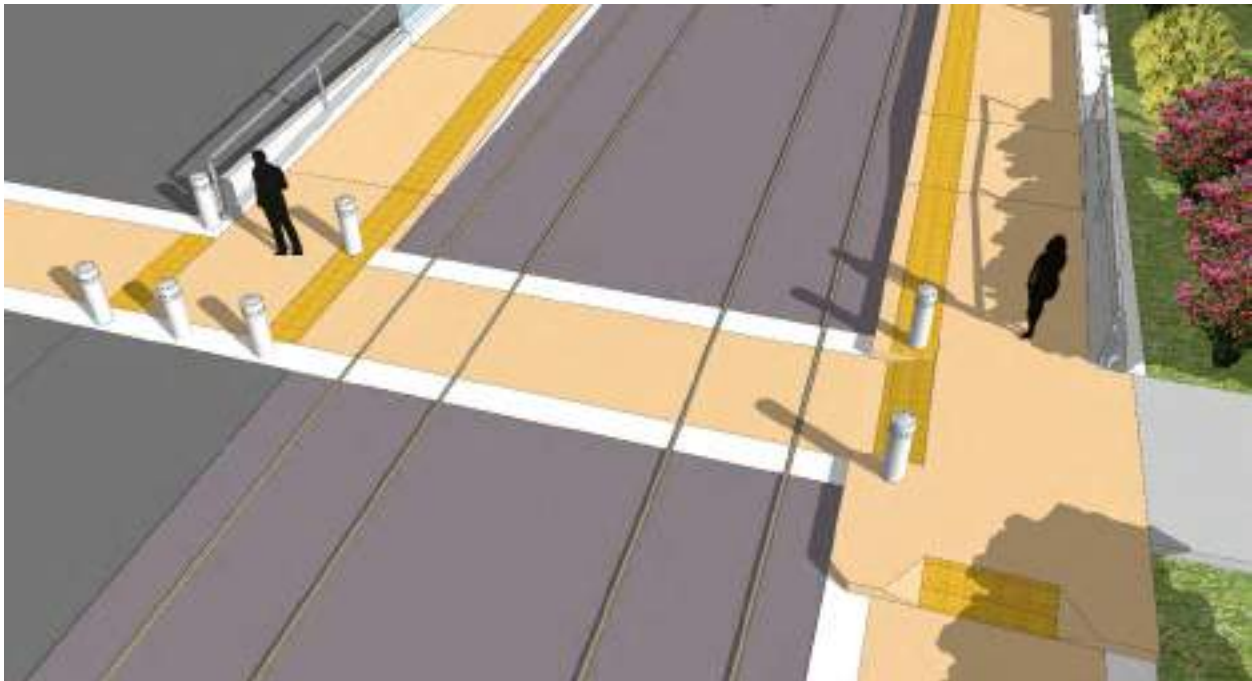

Figure 2-4.3.4: Crossing Treatment, Downtown Opportunity Area Stop Between Landscape Area and Roadway

- C. Notwithstanding the crossing treatments and pedestrian refuge areas detailed in Figure 2-4.3.4 [Crossing Treatment, Downtown Opportunity Area Stop], the paving materials in the Downtown

Opportunity area shall be in accordance with Section 2-4.7 [Downtown Opportunity Area Special Requirements] of this Schedule.

- D. Crosswalks within the WEM Transit Centre shall be in accordance with Section 3-3.3.8 [Crosswalks] of this Schedule.
- E. Crosswalks within the Lewis Farms Park and Ride shall be in accordance with Section 3-4.3.10 [Crosswalks] of this Schedule.

2-4.4 AMENITY NODES

- A. Provide concrete pads for pedestrian Amenity Nodes at the locations shown in Appendix 5-1A [Project Description Drawings] of this Schedule.
- B. Concrete pads for the Amenity Nodes shall comply with Drawings #LA301 and #LA302 of the Valley Line West LRT Landscape Design and Construction Standards.
- C. Provide one (1) bench, one (1) waste receptacle, and one (1) bicycle rack at each Amenity Node; benches, waste receptacles and bicycle racks shall match the ones provided at one (1) of the two (2) adjacent Stops.

2-4.5 SAFETY CUES, SEPARATIONS & BARRIERS

2-4.5.1 General

- A. Provide the least intrusive means necessary, as specified in this Section 2-4.5 [Safety Cues, Separations and Barriers], to provide public safety based on the Safety and Security Certification Program.
- B. Where separations and barriers are provided, they shall be consistent with an open, integrated, and high-quality urban design.
- C. All posts of separations and barriers shall be vertical.
- D. Permitted types of safety cues, separations and barriers and their application are as described in Table 2-4.5.1 [Safety Cues, Separations and Barriers] as a function of their location.

Table 2-4.5.1: Safety Cues, Separations and Barriers

Application	Visual, Auditory, Tactile Cues	Safety Barriers			
		Visual Delineators	Physical Barriers		
			Protection Railings	Fences	LRV and Collision Barriers
Where a Roadway narrows	X				
Where On-track Vehicles share the LRT Corridor with other modes of movement	X				

Application	Visual, Auditory, Tactile Cues	Safety Barriers			
		Visual Delineators	Physical Barriers		
			Protection Railings	Fences	LRV and Collision Barriers
Adjacent to Stops, to direct pedestrians to designated crossing areas	X				
At Kiss and Rides	X				
At pedestrian crossings	X				
Between Trackway and adjacent Roadway	X				
Where visual, auditory or tactile cues are deemed insufficient to provide required safety		X			
Adjacent to Stops, where visual cues are deemed insufficient to provide required safety		X			
Wherever public access is discouraged			X		
On bridges, where cyclists and/or pedestrians are permitted and on top of retaining walls			X		
Where public access is prohibited, and protection of property and equipment is required or where equipment presents a Hazard to public safety				X	
Where required by the Safety and Security Certification Program					X

2-4.5.2 Visual, Auditory and Tactile Cues

- A. Visual, auditory, and tactile cues communicate where persons should, and should not, access or cross the Trackway, Roadway, or bicycle lanes.
- B. Permitted visual, auditory and tactile cues are:
 - 1. differentiated and more prominent paving materials or patterns, such as tactile warnings, to identify where persons are permitted to access or cross the Trackway, Roadway or bicycle lanes;
 - 2. visual and auditory signalization to communicate when it is safe for persons to cross the Trackway, Roadway or bicycle lanes;
 - 3. curbs to separate Trackway from adjacent areas of the LRT Corridor; and
 - 4. bollards shall:
 - a. be Reliance Foundry R-8464-RA or alternate acceptable to the City;
 - b. be 900 mm high;
 - c. be coated with a colour that aesthetically integrates into the overall design of the Stop, Character Zone or streetscape;
 - d. be spaced at a minimum of 2.4 m on centre;
 - e. include lockable and removeable bases with inner covers; and
 - f. be visible at night through incorporation of reflective stripping.

2-4.5.3 Safety Barriers

- A. Safety barriers discourage or prevent access to hazards at locations where less intrusive means is deemed to be insufficient by the Safety and Security Certification Program.
- B. The following safety barriers are not permitted:
 - 1. bedstead barriers, consisting of steel pipe bent in an inverted U-shape with or without one or more horizontal steel pipe members at intermediate height; and
 - 2. safety cages enclosing, or partially enclosing, the walking surface of pedestrian bridges or other pedestrian paths.
- C. Safety barriers shall be one of the following two types:
 - 1. **Visual Delineator:** designed to delineate a boundary between pedestrians or cyclists and hazards.
 - a. Permitted visual delineators are:
 - i. landscaped hedgerows;
 - ii. post and cable fences, with a minimum 3 horizontal rows of vinyl coated cable, with maximum 1000 mm high steel plate posts to be a minimum of 2.4 m on centre (with the short dimension viewed in elevation); and
 - iii. bollards and chains, made of single-braided, grounded stainless steel or PVC rope; and
 - b. Posts shall be installed to the ground surface with concealed or countersunk anchors.
 - 2. **Physical Barrier:** designed as a physical obstacle between pedestrians or cyclists and hazards, enough to resist the applicable forces.

- a. Permitted physical barriers are:
 - i. Protection Railings: refer to Section 2-4.5.3.1 [*Protection Railings*] of this Schedule;
 - ii. fences: refer to Section 2-4.5.3.2 [*Fences*] of this Schedule; and
 - iii. collision barriers: refer to Section 3-2.9 [*Road Appurtenances*] and Section 2-4.5.3.3 [*Collision Barriers*] of this Schedule.

2-4.5.3.1 Protection Railings

- A. Protection Railings shall be visually light and integrate with the architecture of the Structure to which the Protection Railing is attached and to the surrounding context.
- B. A Protection Railing shall be placed adjacent to the skylight on the west side of the Orange Hub. This Protection Railing shall:
 - 1. provide a separation between the sidewalk and the skylight; and
 - 2. resemble Killeshal “Mannus” flat top, Model DFE10/3, stainless steel bollards, tensile cable barrier, utilizing a model that comes with or without handrails, or alternate acceptable to the City.
- C. Gates in Protection Railings shall incorporate the same aesthetic as the Protection Railing.
- D. Except as otherwise specified in this Schedule, Protection Railings shall comply with Table 2-4.5.3.1 [*Protection Railings*]; for the purposes of this Table, the word “transparency” is defined as the percentage of opening size to total area when viewed in elevation.
- E. All steel components of Protection Railings shall be galvanized except as otherwise specified in this Schedule.
- F. Chain link mesh shall not form a component of Protection Railings.
- G. Protection Railings shall be placed as near to the outside edge of a retaining wall as possible to prevent attempts to walk along the exterior side of the Protection Railing.

Table 2-4.5.3.1: Protection Railings

Where Required	Technical Requirements	Aesthetic Requirements
Above a drop height of 1.2 m or greater, where the area above the drop is not designated for public use.	Fall arrest “Guardrail” in accordance with Alberta Occupational Health & Safety Code	Horizontal members shall be cables. Posts shall be steel plate with the short dimension viewed in elevation. Posts shall be spaced at a minimum of 2.4 m. At end conditions, cables shall be tapered downwards to a common anchor point at a slope of 1 vertical: a minimum of 4 horizontal. Minimum transparency: 95%

Where Required	Technical Requirements	Aesthetic Requirements
<p>On SUPs and Roadways where bicycle traffic is permitted above a drop height exceeding 0.6 m and along the outside of the pedestrian sidewalk on the Stony Plain Road Bridge.</p>	<p>Bicycle barrier in accordance with CAN/CSA S6, except that there shall be no opening that permits the passage of a sphere whose diameter is 100 mm or greater</p>	<p>Posts shall be spaced at a minimum of 2.4 m, unless expressly stated otherwise.</p> <p>Protection Railings shall be composed of solid steel bar, closed steel sections, or cables.</p> <p>Minimum transparency: 80%</p>
<p>Above drops exceeding a drop height of 0.6 m on paths where pedestrian traffic is permitted, but bicycle traffic is not permitted.</p>	<p>Pedestrian barrier in accordance with CAN/CSA S6, except that there shall be no opening that permits the passage of a sphere whose diameter is 100 mm or greater</p>	<p>Posts shall be spaced at a minimum of 2.4 m.</p> <p>Protection Railings shall be composed of solid steel bar, closed steel sections, or cables.</p> <p>Minimum transparency: 80%</p>
<p>At the interface of Platforms adjacent to Roadways or to bicycle lanes, where the Platform runs parallel to the Roadway or bicycle lane, except where:</p> <ul style="list-style-type: none"> • a landscaped boulevard of at least 3 m is provided between the Platform and the Roadway or bicycle lane; or • where the Roadway is a service road and the Safety and Security Certification Program demonstrates that a Protection Railing is not required. 	<p>Guard in accordance with NBCAE</p>	<p>Protection Railing shall be composed of solid steel bar or closed steel sections and glass and shall act as splash protection, i.e. be solid for the entire height of the Protection Railing.</p> <p>Minimum transparency: 90%</p> <p>All steel shall be stainless (Grade 316L).</p>
<p>At the interface of Platforms adjacent to pedestrian areas where the drop exceeds 0.3 m.</p>	<p>Guard in accordance with NBCAE</p>	<p>Protection Railing shall be composed of solid steel bar or closed steel sections and glass and shall act as splash protection, i.e. be solid for the entire height of the Protection Railing.</p> <p>Minimum transparency: 90%</p> <p>All steel shall be stainless (Grade 316L).</p>

2-4.5.3.2 Fences

- A. In keeping with the urban-integrated design vision for the Project, the use and extent of fences shall be minimized.
- B. Chain link fence is not permitted, except for existing chain link fences removed during Construction, which shall be replaced with new materials matching the existing chain link fence.
- C. Barbed, razor, and similar wire fencing materials are not permitted, except where an existing fence having barbed, razor, or similar wire fencing materials is removed during Construction, in which case the material shall be replaced with new materials matching the existing fencing.
- D. Fences shall be either standalone ornamental welded wire mesh fencing or ornamental welded wire mesh fencing, integrated with barriers such as Roadway vehicle collision barriers where applicable and shall meet the following requirements:
 - 1. have a transparency of a minimum of 80% when viewed in elevation, where transparency is the percentage of opening size to total fence area for standalone fences and to the fence portion of fences integrated with barriers;
 - 2. have only vertical and horizontal elements when viewed in elevation;
 - 3. have fence posts consisting of closed structural sections, not exceeding 76 mm in width when viewed in elevation;
 - 4. have wires no greater than 5 mm in diameter;
 - 5. have a fence height measured from adjacent ground not exceeding 2.5 m, and being a minimum of 1.8 m for the fences surrounding the Gerry Wright OMF Building B and the Lewis Farms Storage Facility;
 - 6. have posts spaced no less than 2.3 m;
 - 7. be coloured black;
 - 8. follow vertical curves to match the grade without abrupt angular changes; and
 - 9. notwithstanding Section 2-4.5.3.2D.8 [*Fences*], the top of fences may be stepped such that the horizontal measurement between steps is in constant proportion to the vertical change and shall not be steeper than 1 vertical to 6 horizontal; the absolute height change at a discrete step in fence height shall not exceed 300 mm.
- E. Notwithstanding Section 2-4.5.3.2 [*Fences*], provide Property Fences in accordance with Section 1-2.2 [*Property Fences*] of this Schedule.

2-4.5.3.3 LRV and Collision Barriers

- A. Where LRV barriers are required in accordance with Section 4-2.9.2 [*LRV Barriers*] of this Schedule, they shall:
 - 1. consist of a continuous, round, horizontal steel top rail and round, horizontal intermediate rails that are evenly spaced between the top of the concrete curb and the top rail, supported by curved and tapered built-up steel plate posts nominally arranged as shown in Figure 2-4.5.3.3 [*LRV Barrier*];
 - 2. have support posts spaced no less than 2.4 m on centre;
 - 3. have a transparency of a minimum of 60% when viewed in elevation, where transparency is the percentage of opening size to total area using the height “H” shown in Figure 2-4.5.3.3 2-4.5.3.3 [*LRV Barrier*]; and

4. comply with Alberta Occupational Health & Safety Code requirements.

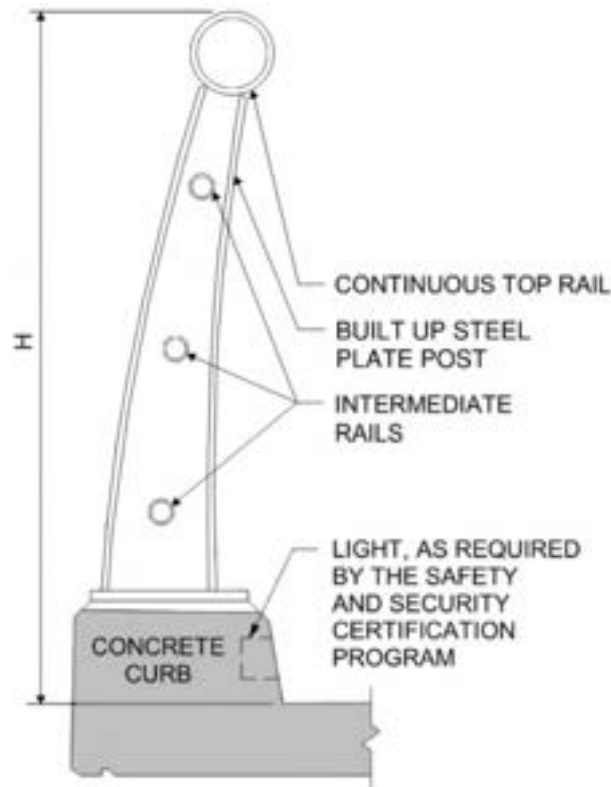

Figure 2-4.5.3.3: LRV Barrier

B. Roadway vehicle collision barriers shall:

1. consist of smooth horizontal and vertical curves nominally consistent with the adjacent Roadway;
2. be concrete;
3. taper linearly in elevation at terminations; and
4. be designed in accordance with Section 3-2.9 [*Road Appurtenances*] of this Schedule and CAN/CSA S6.

2-4.5.4 Intertrack Barriers

- A. Barriers between the Tracks are not permitted.

2-4.5.5 Special Protection Fence

- A. Provide a protection fence along the south side of 87 Avenue between the TUC and 187 Street as shown on Figure 5-1A-04 to Figure 5-1A-05 of Appendix 5-1A [*Project Description Drawings*] of this Schedule, adhering to the following:
1. the requirements of Drawing #LA405 of the Valley Line West LRT Landscape Design and Construction Standards; and
 2. be constructed within 300mm of the property line, on City property.

- B. Where there is an existing Property Fence nominally perpendicular to the protection fence required in accordance with Section 2-4.5.5A [*Protection Fence*] of this Schedule, extend the existing Property Fence with matching construction so as to tie into the new protection fence.

2-4.5.6 Other Separations

- A. Except where demonstrated to be necessary by the Safety and Security Certification Program or as otherwise specified in this Schedule, no barriers, fences, or other physical separations between the Trackway and adjacent amenities, such as sidewalks, SUPs, Roadways, and Landscaped Areas, are permitted.
- B. Except as otherwise specified in Table 2-4.5.3.1 [*Protection Railings*], no barriers, fences, or other physical separations between the Platform and adjacent amenities, such as sidewalks, SUPs and Landscaped Areas, are permitted.

2-4.5.7 TUC Maintenance Fence

- A. Provide a 1380 mm high post and cable fence in accordance with Section 2-4.5.3C.1 [*Safety Barriers*] of this Schedule along the north and south side of the Trackway within the Transportation Utility Corridor as shown on Figure 5-1A-02 to Figure 5-1A-04 of Appendix 5-1A [*Project Description Drawings*] of this Schedule.

2-4.5.8 TUC Farm Fence

- A. Notwithstanding Section 2-4.5.3.2C [*Fences*] of this Schedule, provide a barbed wire farm fence in accordance with Drawing CB-6-2.12M2 [*Class 'B' Fence*] of the Alberta Transportation Highway Geometric Design Guide as shown on Figure 5-1A-04 of Appendix 5-1A [*Project Description Drawings*] of this Schedule.

2-4.6 CRIME PREVENTION THROUGH ENVIRONMENTAL DESIGN (CPTED)

- A. This Section 2-4.6 [*Crime Prevention Through Environmental Design (CPTED)*] sets out the requirements for Crime Prevention Through Environmental Design (CPTED).
- B. CPTED is a multidisciplinary approach to planning, design, and construction that deters criminal behaviour through natural access control (entry and exit points, fences), boundaries (clear ownership, clearly marked private spaces) and natural surveillance (visibility, positive social activities).
- C. The Design and Construction of the Infrastructure shall apply CPTED principles as set out in the City's *Design Guide for a Safer City* and this Section 2-4.6 [*Crime Prevention Through Environmental Design (CPTED)*].
- D. Submit to the City a report twelve (12) months after the Effective Date a report (the "**CPTED Report**") confirming how CPTED principles will be applied to the Project, including but not limited to the following:
 1. information from site visits including a record of observed existing conditions and context along the LRT Corridor;
 2. identify of areas of concern and describe those concerns;
 3. identify possible impacts of the Infrastructure, including associated mitigation recommendations; and
 4. for each area, review of the local crime and safety context on the Neighbourhood Crime Map from the Edmonton Police Service website and include mitigation recommendations.

2-4.6.1 Natural Access Control

- A. Provide natural access control through use of architectural, landscaping, and structural elements to discourage access to areas for uses other than those intended, by:
 - 1. designing indoor and outdoor spaces to discourage public access into dark and unmonitored areas;
 - 2. providing visual cues to prevent unauthorized pedestrian and vehicular access;
 - 3. using lighting to define pedestrian pathways at night; and
 - 4. where the use of items 1, 2 and 3 are not feasible, employing target hardening techniques.

2-4.6.2 Natural Boundaries

- A. Provide territorial reinforcement through use of physical cues to identify and reinforce secure or restricted areas, by:
 - 1. providing clearly marked transitional zones to acknowledge movement into a restricted space and clearly define the boundaries of the restricted space;
 - 2. using elements such as signage, landscaping, tactile surfaces, low walls, artwork, seating, and similar elements to define desired movement areas; and
 - 3. where the use of items 1 and 2 are not feasible, employing target hardening techniques.

2-4.6.3 Natural Surveillance

- A. Provide natural surveillance through use of features that maximize visibility of Platform areas, Stops and Stations, parking areas, pathways, building perimeters and building entrances, by:
 - 1. designing site elements (landscaping, walls, bridges, guideway ramps, piers, etc.) to eliminate or minimize hidden places or areas for concealment such as hidden corners, blind spots and bends that create places of concealment or limit choices;
 - 2. maximizing transparency of transit shelters and elevators to allow observation of activity within and outside of the Structure;
 - 3. designing building facades to achieve a minimum of 50% transparency and use glazing to encourage passive surveillance of exterior areas;
 - 4. avoiding recesses, alcoves and concealed areas suitable for hiding;
 - 5. avoiding dead end corridors and areas having only one (1) exit;
 - 6. placing services, such as TVMs, bicycle racks, and emergency phones in safe locations that are widely observable from other locations on the site;
 - 7. locating areas, such as accessible parking, confined circulation systems (such as guideway ramps, lifts, escalators and stairs) and gathering places, where they are easily observable;
 - 8. creating spaces with large fields and long lines of vision;
 - 9. maximizing natural lighting of areas during daylight hours; and
 - 10. providing adequate night time lighting to minimize shadows and glare.

2-4.7 DOWNTOWN OPPORTUNITY AREA SPECIAL REQUIREMENTS

- A. This Section 2-4.7 [*Downtown Opportunity Area Special Requirements*] sets out special requirements for the Downtown Opportunity Area; in the event of any conflict, ambiguity or inconsistency between or among the requirements of this Section 2-4.7 [*Downtown Opportunity Area Special Requirements*]

and any other provision of the Project Agreement, the requirements of this Section 2-4.7 [*Downtown Opportunity Area Special Requirements*] shall prevail.

- B. The urban realm and streetscaping in the Downtown Opportunity Area west of 103 Street shall conform to Appendix 5-2A [*102 Avenue – 107 Street Streetscape Drawings*] of this Schedule and to the Valley Line West LRT Design Guide, including:

1. paving materials:
 - a. sidewalk and Platform pavers: Unilock Umbriano Granada White™;
 - b. cycle track pavers: Unilock Umbriano Midnight Sky™ or alternate acceptable to the City;
 - c. green cycle track paint markings through intersections shall be as shown in Figure 2-4.7.1-1 [*Cycle Track Paint Markings – High Level Conflict Zone*] and shall be applied to pavers specified in this Section 2-4.7 [*Downtown Opportunity Area Special Requirements*] of this Schedule;

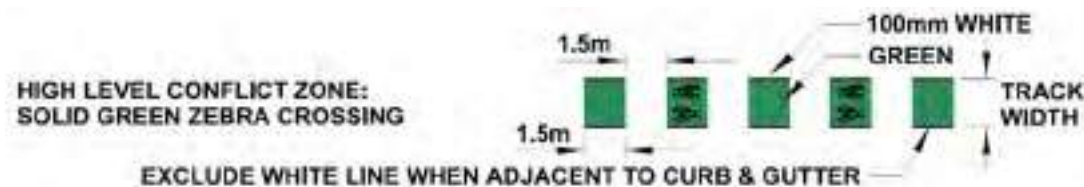

Figure 2-4.7.1-1: Cycle Track Paint Markings – High Level Conflict Zone

- d. delineation pavers between east - and westbound bicycle traffic, and vehicular and cycle track stop bars: Unilock Series 3000 Glacier™ or alternate acceptable to the City;
- e. roadway pavers: Unilock Umbriano French Grey™ except:
 - i. on 107 Street, the vehicle travel lane and fire lane shall be cast-in-place concrete;
- f. pavers for transverse bands: Unilock Il Campo Heritage Brown™ or alternate acceptable to the City;
- g. pavers for amenity zones at the sidewalk edges away from buildings: Unilock Il Campo Heritage Brown™ or alternate acceptable to the City;
- h. Trackway: Interstar Ready Mix Black Onyx (NR-5790R 2 bag) Integrally Coloured Concrete with sawcut and broom finish;
- i. delineation between cycle track and Roadway: according to Section 3.-2.11.11 [*102 Avenue (107 Street to 102 Street)*] and Section 2-4.7 [*Downtown Opportunity Area Special Requirements*] of this Schedule;
- j. delineation between Roadway and Trackway: according to Section 3.-2.4.6 [*Curb and Gutter*] of this Schedule;
- k. delineation between Roadway and planted median: curb and gutter according to drawing #5023 or #5024 in the Valley Line West LRT Roadways Design and Construction Standards;
- l. bicycle safe zone: pavers specified in Section 2-4.7.B.1.b painted with nominally Pantone 354 and subject to Section 3-2.8.3.A [*Pavement Markings*] of this Schedule;
- m. crosswalks, 5.0 m wide:

- i. 480 mm wide white concrete edge strips, using exclusively white cement for all cementitious materials or other means acceptable to the City to provide “white” concrete at both outside edges of the crosswalk; and
 - ii. pavers for the 4.04 m wide area between the white concrete strips: Unilock II Campo Heritage Brown™ or alternate acceptable to the City;
- n. curb ramps: as shown in Figures 2-4.7.1-1-2 [*Tactile Warning Surface Indicator Layout, Full Radius Curb Ramp*] to Figure 2-4.7.4 [*Tactile Warning Surface Indicator Orientation, Offset Intersection*]; tactile warning surface indicators shall:
- i. be Advantage® Cast Iron Premier plates with an uncoated natural patina finish or alternate acceptable to the City;
 - ii. be installed in accordance with the manufacturer’s written instructions and specifications and in compliance with ISO 23599 *Assistive products for blind and vision-impaired persons -- Tactile walking surface indicators*; and
 - iii. be surrounded by white concrete, using exclusively white cement for all cementitious materials or other means acceptable to the City to provide a “white” concrete;

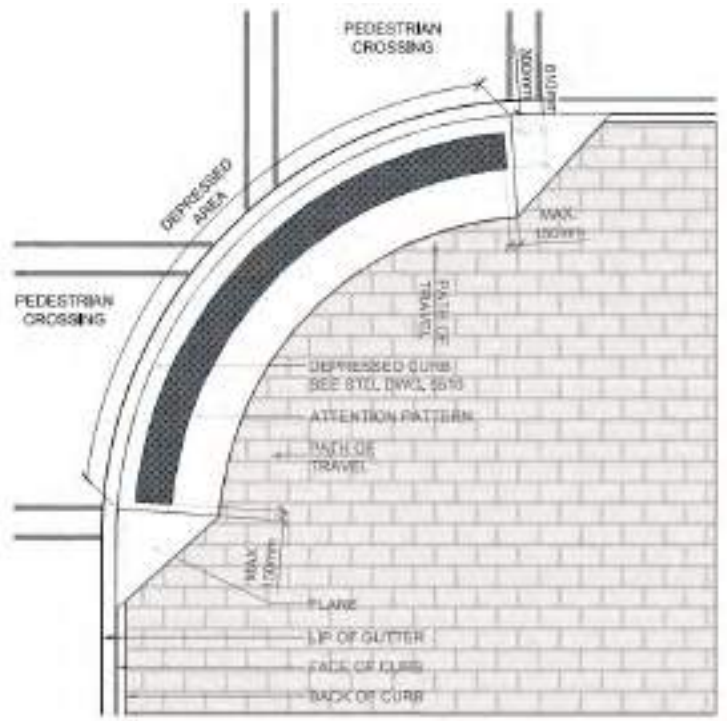

Figure 2-4.7.1-2: Tactile Warning Surface Indicator Layout, Full Radius Curb Ramp

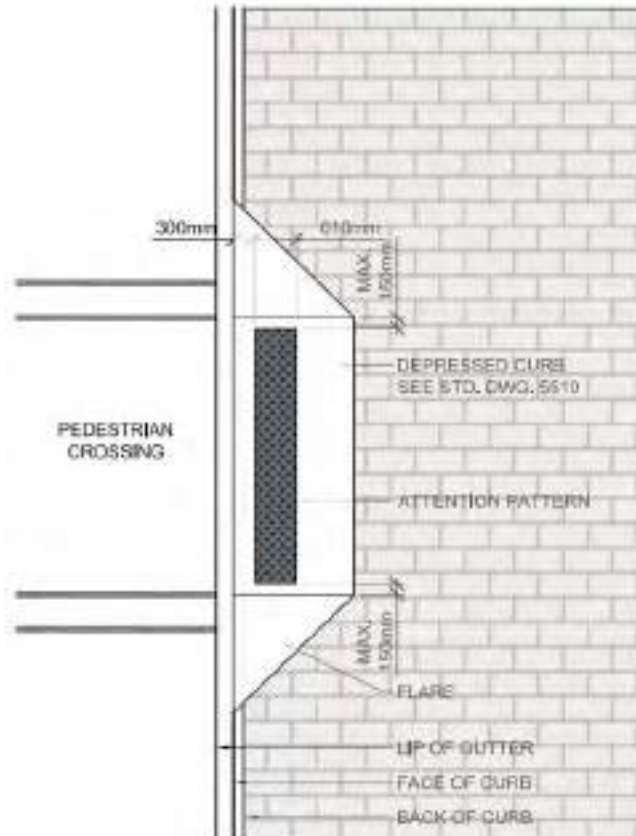

Figure 2-4.7.2: Tactile Warning Surface Indicator Layout, Mid-Block Crossing

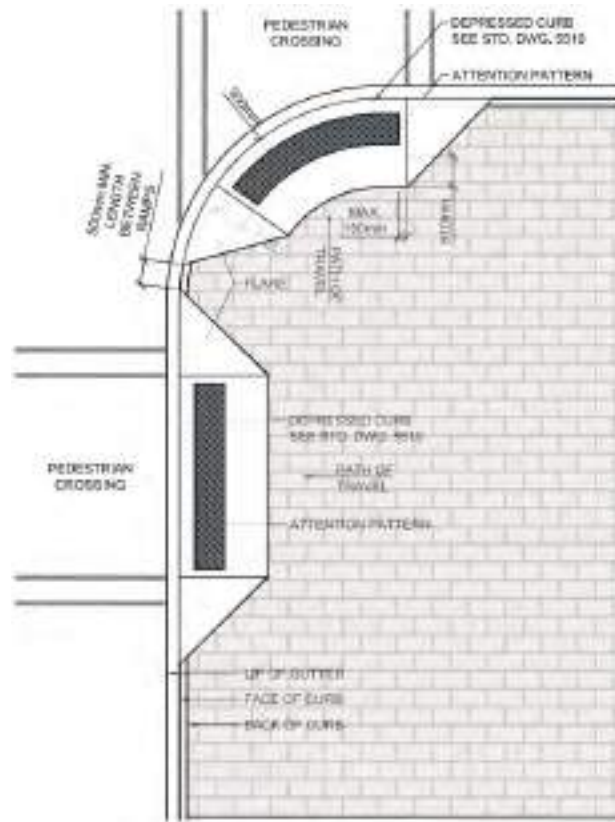

Figure 2-4.7.3: Tactile Warning Surface Indicator Layout, Separate Curb Ramps

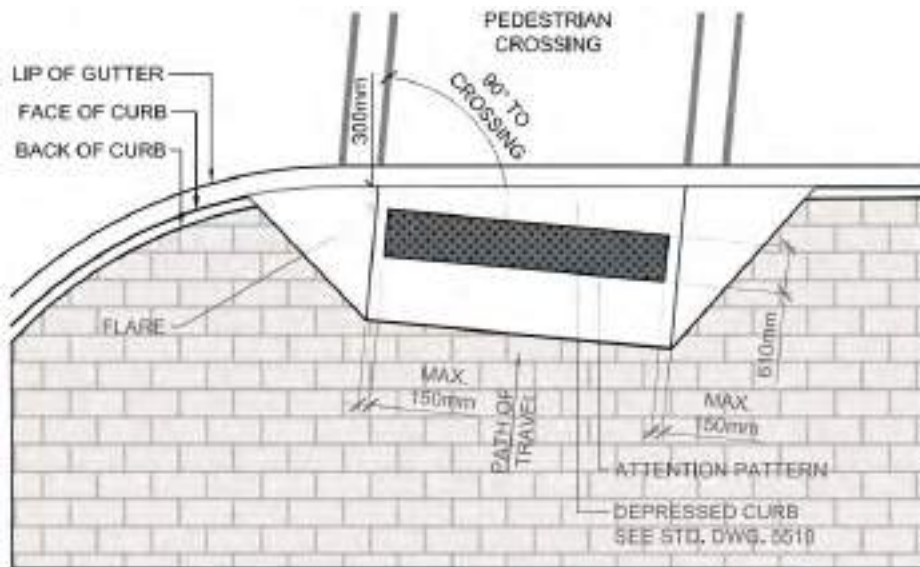

Figure 2-4.7.4: Tactile Warning Surface Indicator Orientation, Offset Intersection

- o. curbs, gutters and headers between sidewalk and cycle track, between sidewalk and Roadway, between cycle track and Roadway, and between Trackway and sidewalk: white concrete, using exclusively white cement for all cementitious materials or other means acceptable to the City to provide a “white” concrete;

- p. curbs, gutters and headers between Roadway and Trackway: natural coloured concrete;
 - q. supply and install all pavers in accordance with Section 02783 of the Valley Line West LRT Roadways Design and Construction Standards and the manufacturer's written instructions and specifications;
 - r. all pavers shall be installed with a 1/3 offset running bond pattern;
 - s. sidewalk pavers shall extend to building face, except where grade changes occur between the sidewalk and the building face, such as at stairs and accessibility ramps, in which case the sidewalk pavers shall only extend to start of the grade change; and
 - t. pavers shall extend down side streets as shown in Appendix 5-2A [*102 Avenue – 107 Street Streetscape Drawings*];
2. Amenity areas in the amenity zones shown in Appendix 5-2A [*102 Avenue – 107 Street Streetscape Drawings*] shall:
- a. be designed and constructed to include soils, planting, a concrete slab, and benches;
 - b. include a 300 mm wide x 150 mm high above-grade precast concrete curb exposed to Public View around planted amenity areas along the edge adjacent to the Roadway or cycle track; curbs shall be made of Integrally Coloured Concrete with a colour and finish matching the Unilock II Campo Heritage Brown™ pavers;
 - c. include 200 mm wide x 150 mm high above-grade precast concrete curbs exposed to Public View around planted amenity areas along any edges which abut the sidewalk; curbs shall be made of concrete with a colour and finish matching the Unilock II Campo Heritage Brown™ pavers; and
 - d. integrate benches as shown in Appendix 5-2A [*102 Avenue – 107 Street Streetscape Drawings*] of this Schedule into amenity areas;
3. OCS and light poles:
- a. OCS shared use poles, in-fill Roadway light poles and pedestrian light poles with light arms and fixtures shall be consistent with the imagery shown in the Valley Line West LRT Design Guide, and as follows:
 - i. OCS shared use pole light fixtures: LIGMAN Lighting Steamer Large Rectangular Streetlight USE 90012, metallic silver (colour code RAL 9006) or alternate acceptable to the City;
 - ii. in-fill Roadway light pole light fixtures: LIGMAN Lighting Steamer Large Rectangular Streetlight USE 90012, black (colour code RAL 9011) or alternate acceptable to the City; and
 - iii. pedestrian light pole light fixtures: LIGMAN Lighting Steamer Medium Rectangular Streetlight USE 90002, black (colour code RAL 9011) or alternate acceptable to the City;
 - b. All light poles and traffic signal poles, including all attached supporting arms, shall be galvanized and coated to have an appearance matching the light fixtures, black (colour code RAL 9011), in accordance with Section 2.2 [*Coatings for Galvanized Steel (B2010.10)*] in the Valley Line West LRT Facilities Design and Construction Standards;
 - c. Traffic signal poles shall be cantilevered structures;

- d. OCS and in-fill Roadway light poles shall only be placed:
 - i. on the north sidewalk and in the median space between the Trackway and the Roadway from the east project boundary to the Track curve between 106 and 107 Street on 102 Avenue, lining up with a pedestrian light pole on the south sidewalk; and
 - ii. within the Trackway between the Track curves from 102 Avenue to 104 Avenue on 107 Street, lining up with the pedestrian light poles on the sidewalks;
- e. free-standing pedestrian light poles on the north and south sidewalks of 102 Avenue and east and west sidewalks of 107 Street shall be placed at a 10 m spacing rhythm and as follows:
 - i. attachments of the pedestrian light poles to the base shall be designed and constructed such that pole verticality can be easily adjusted when required;
 - ii. where an OCS pole is provided on a sidewalk, pedestrian light fixtures shall be integrated with the shared-use OCS pole and shall match the colour and finish of the OCS pole;
 - iii. where no amenity areas are provided, free standing pedestrian poles shall be provided along the edge of the sidewalk adjacent to the Trackway, Roadway or cycle track to maximize the clear width of sidewalk for pedestrians;
 - iv. where amenity areas are provided along the south sidewalk of 102 Avenue, the free-standing pedestrian light poles shall be located in the middle of the amenity area curb, adjacent to the Roadway or cycle track;
 - v. where amenity areas are provided along the west sidewalk of 107 Street, the free-standing pedestrian light poles shall be centered between amenity areas along the edge of the sidewalk adjacent to the Trackway to maximize the clear width of sidewalk for pedestrians; and
 - vi. free standing pedestrian poles on both sides of 102 Avenue and 107 Street shall be aligned;
- f. provide power to pedestrian street lights and LED amenity areas;
 - i. all pedestrian lighting and bench lighting cable terminations shall be performed inside the hand hole of the closest shared use or pedestrian light pole;
 - ii. power feed shall be provided from power lines running in the median between the Trackway and the Roadway and branching out nominally perpendicular to the line of OCS and in-fill Roadway light poles; and
 - iii. electrical connections to the amenity areas shall be provided with disconnect capabilities;
- g. provide neighbourhood banner supports for all OCS and in-fill Roadway light poles not adjacent to a Roadway or within the Trackway, and to all pedestrian light poles that are in line transversely to the LRT Corridor with an OCS or in-fill Roadway light pole. The banner supports shall:
 - i. be designed such that the upper banner support is below the pedestrian light arms, where provided;
 - ii. be installed so that the bottom of the banner is at least 3.0 m above the grade around the pole;

- iii. be consistent in shape and proportional with the pedestrian light arms;
 - iv. be mounted at a consistent height along the LRT Corridor;
 - v. be designed to accommodate banners with a maximum size of 0.6 m wide and 1.5 m long;
 - vi. have fasteners that are concealed and comply with all other SUI Principles regarding shared use and integration of components;
 - vii. be perpendicular to the Roadway and oriented towards the pedestrian area;
 - viii. be consistent with the colour and finish of the pole to which they are mounted to; and
 - ix. be designed such that the distance from the outside edge of the proposed banner to the curb face shall be a minimum of 0.4m;
4. bike racks: Reliance Foundry R-7906, coated black (colour code RAL 9011) or alternate acceptable to the City;
5. benches:
- a. Oliver James Site Furnishings, model Heritage Park Bench, or alternate acceptable to the City;
 - b. minimum 2438 mm long;
 - c. surface mounted;
 - d. Ipe slats; and
 - e. coated black (colour code RAL 9011) or alternate acceptable to the City;
6. cycle track along 102 Avenue at the same level as the Roadway;
7. bollards:
- a. where required in accordance with Section 2-4.3 [*Crossing Treatments*] of this Schedule:
 - i. Reliance Foundry R-8464-RA, coated black (colour code RAL 9011), or alternate acceptable to the City;
 - ii. 900 mm high;
 - iii. include lockable and removable bases with inner covers; and
 - iv. be visible at night through incorporation of reflective stripping.
 - b. between the cycle track and the Roadway at each side of an intersection:
 - i. four (4) green 1067 mm high Pexco FG 300 UR flex posts with Metro Bases, or alternate acceptable to the City;
 - ii. mounted to low-height concrete parking curbs;
 - iii. aligned with the transverse bands;
 - iv. be visible at night through incorporation of reflective stripping; and

- v. spaced at 2.5 m; and
- c. elsewhere in the Downtown Opportunity Area, as required by the Safety and Security Certification Program:
 - i. Reliance Foundry R-7691, coated black (colour code RAL 9011), or alternate acceptable to the City; and
 - ii. 990 mm high.
- 8. waste receptacles consistent with the waste and recycling receptacles provided at the Stops in the Downtown Opportunity Area;
- 9. tree grates:
 - a. In Alex Decoteau Park and along 102 Avenue between 102 Street and 103 Street:
 - i. “Jamison” by Urban Accessories or alternate acceptable to the City; and
 - ii. cast iron, raw natural finish; and
 - b. elsewhere within the Downtown Opportunity Area:
 - i. R-8710 or R-8811 by Norwood Foundry Limited or alternate acceptable to the City; and
 - ii. cast iron, raw natural finish; and
- 10. replace concrete infill panels at existing in-ground vaults and air intakes with cast-in-place Integrally Coloured Concrete of a consistent colour and design, integrated with the adjacent streetscaping.
- C. The transition from the north sidewalk to the Trackway along 102 Avenue between 103 Street and 107 Street and from the west sidewalk to the Trackway along 107 Street between 102 Avenue and 104 Avenue shall comply with Section 3-2.11.10 [*107 Street (104 Avenue to 102 Avenue)*] and Section 3-2.11.11 [*102 Avenue (107 Street to 102 Street)*] of this Schedule.
- D. Refer to the Valley Line West LRT Design Guide and Section 1-2.10.8 [*Interface with Valley Line LRT Stage 1 along 102 Avenue*] and Appendix 5-2A [*102 Avenue – 107 Street Streetscape Drawings*] of this Schedule for paving materials and furnishings to be used along 102 Avenue between 102 Street and 103 Street, which shall be procured by the City as part of the Valley Line Stage 1 contract and supplied to Project Co for use in that segment.
- E. The top of concrete of the Embedded Trackway in the Downtown Opportunity Area shall be the same on either side of a rail.

2-4.8 JASPER PLACE OPPORTUNITY AREA SPECIAL REQUIREMENTS

- A. This Section 2-4.8 [*Jasper Place Opportunity Area Special Requirements*] sets out special requirements for the Jasper Place Opportunity Area. In the event of any conflict, ambiguity or inconsistency between or among the requirements of this Section 2-4.8 [*Jasper Place Opportunity Area Special Requirements*] and any other provision of the Project Agreement, the requirements of this Section 2-4.8 [*Jasper Place Opportunity Area Special Requirements*] shall prevail.
- B. The urban realm and streetscaping in the Jasper Place Opportunity Area shall conform to Appendix 5-2B [*Jasper Place Opportunity Area Streetscape Drawings*] of this Schedule and to the Valley Line West LRT Design Guide, including:
 - 1. paving materials:

- a. sidewalks: combination of Integrally Coloured Concrete in the following colours and finishes or alternates acceptable to the City:
 - i. Interstar Monsoon (NR-5157R 2 bags), sawcut and broom finish. Sawcuts spaced in general conformance with existing sawcuts;
 - ii. Interstar Fox Red (NR-2815R 2 bags), sawcut and broom finish. Sawcuts spaced in general conformance with existing sawcuts;
 - iii. Interstar Gold (JN-4010R 2 bags), sawcut and broom finish. Sawcuts spaced in general conformance with existing sawcuts; and
 - iv. Interstar Balsam Wood (BN-2680R 2 bags), broom finish, hand troweled at 200mm on centre;
- b. Platforms: Integrally Coloured Concrete in Interstar Gold (JN-4010R 2 bags) sawcut and broom finish;
- c. Roadways: asphalt, with asphalt stamped in Euro Fan pattern in colour Pewter to match existing as shown in Appendix 5-2B [*Jasper Place Opportunity Area Streetscape Drawings*] of this Schedule, or alternate acceptable to the City;
- d. delineation between Roadway and Trackway: according to Section 3-2.4.5.A.2 [*Curb and Gutter*] of this Schedule;
- e. crosswalks, 5.0 m wide;
 - i. 480 mm wide white concrete edge strips, using exclusively white cement for all cementitious materials or other means acceptable to the City to provide a “white” concrete at both outside edges of the crosswalk; and
 - ii. Integrally Coloured Concrete for the 4.04 m wide area between the white concrete strips: Interstar Gold (JN-4010R 2 bags) with sawcut broom finish;
- f. curb ramps: concrete with sawcut broom finish and in accordance with drawing #5510 of the Valley Line West LRT Roadways Design and Construction Standards;
- g. curbs:
 - i. provide new concrete curbs, including gutter and header, between Roadway and Trackway and between sidewalk and Roadway, in areas disrupted by Construction;
 - ii. the header shall be typically 600 mm; and
 - iii. where the total sidewalk width is to be increased, and the existing walk is retained, a new header may be constructed to accommodate the increased width;
- h. where there is a Utility Right of Way agreement, sidewalk paving treatments shall extend to building face, except where grade changes occur between the sidewalk and the building face, such as at stairs and accessibility ramps, in which case the paving treatment shall extend only to the start of the grade change;
- i. new stairs and accessibility slopes shall be constructed with Integrally Coloured Concrete matching the predominant colour of the adjacent sidewalk surfaces;
- j. steps shall be provided with a contrasting tread edge;

- k. paving on sidewalks shall extend down the side streets to match the limits of the corresponding roadway tie-in locations and shall match any existing pattern;
2. OCS and Light poles:
 - a. OCS shared use poles, in-fill Roadway light poles and pedestrian light poles with light arms and fixtures shall be consistent with the imagery shown in the Valley Line West LRT Design Guide, and as follows:
 - i. Roadway/Trackway light fixtures: Lumec Renaissance RN30 flat lens luminaire and Lumec Renaissance RNS30 lens guard, pearl dark grey (colour code RAL 9023) or alternate acceptable to the City; and
 - ii. pedestrian light fixtures: Lumec UrbanScape MPTC luminaire, pearl dark grey (colour code RAL 9023) or alternate acceptable to the City;
 - b. all OCS shared use poles, light poles and traffic signal poles, including all supporting arms, shall be galvanized, and coated in colour pearl dark grey (colour code RAL 9023), reasonably matching the existing poles, in accordance with Section 2.2 [*Coatings for Galvanized Steel (B2010.10)*] in the Valley Line West LRT Facilities Design and Construction Standards;
 - c. free-standing pedestrian light poles on the sidewalks shall be placed at maximum 24 m spacing along the edge of the sidewalk adjacent to the Roadway or Trackway to maximize the clear width of sidewalk for pedestrians and shall align with OCS shared use poles and/or in-fill Roadway light poles, and:
 - i. where an OCS pole is provided on a sidewalk, pedestrian lights shall be integrated with the shared-use OCS pole instead of free standing;
 - ii. where a clear width of sidewalk for pedestrians of at least 1.5 m cannot be achieved, pedestrian light poles need not be provided; and
 - iii. free standing pedestrian poles on both sides of Stony Plain Road and 156 Street shall be aligned;
 - d. existing lighting control systems for roadway and pedestrian lighting shall be maintained in accordance with Section 6-6.3.2 [*Jasper Place Opportunity Area Specific Requirements*];
 3. bike racks: City of Edmonton post and ring style “Q” rack, or alternate acceptable to the City;
 4. benches:
 - a. Landscape Forms model Arcata, backed or backless, or alternate acceptable to the City;
 - b. minimum 1900 mm long;
 - c. with end and intermediate arm rests;
 - d. surface mounted; and
 - e. coated pearl dark grey (colour code RAL 9023) or alternate acceptable to the City;
 5. cluster seating:
 - a. Landscape Forms model Arcata Picnic Table;
 - b. surface mounted; and

- c. coated pearl dark grey (colour code RAL 9023) or alternate acceptable to the City;
6. bollards:
- a. where required in accordance with Section 2-4.3 [*Crossing Treatments*] of this Schedule or the drawings in Appendix 5-2B [*Jasper Place Opportunity Area Streetscape Drawings*] of this Schedule:
 - i. Forms+Surfaces, Helio model, coated in pearl dark grey (colour code RAL 9023);
 - ii. 1016 mm high;
 - iii. include lockable and removable bases with inner covers;
 - iv. visible at night through incorporation of reflective stripping or integral LED lighting where applicable; and
 - v. spaced at 2.5 m and aligned with the transverse bands where applicable;
 - 7. waste receptacles consistent with the waste and recycling receptacles provided at the Stops in the Jasper Place Opportunity Area;
 - 8. bistro tables consistent with the existing bistro tables in the Jasper Place Opportunity Area;
 - 9. concrete seat walls consistent with the existing concrete seat walls in the Jasper Place Opportunity Area;
 - 10. tree grates consistent with the existing custom tree grates in the Jasper Place Opportunity Area, including the 100 mm square opening for electrical equipment for secondary lighting as described in Section 6-6.3.2 [*Jasper Place Opportunity Area Specific Requirements*] of this Schedule; and
 - 11. newspaper corrals, decorative screens, posting kiosks, parkette trellises and illuminated concrete street monuments or “street identifiers” salvaged from the existing streetscape in accordance with Section 1-7.5.6A [*Jasper Place Opportunity Area Furnishings*] of this Schedule.
- C. The top of concrete of the Embedded Trackway in the Jasper Place Opportunity Area shall be the same on either side of a rail.
- D. Reinstall the existing Jasper Place Opportunity Area furnishings identified in Section 1-7.5.6 [*Jasper Place Opportunity Area Furnishings*] of this Schedule in accordance with the drawings in Appendix 5-2B [*Jasper Place Opportunity Area Streetscape Drawings*] of this Schedule such that the materials and components are not damaged during the reinstallation.
- E. Extend the design themes and streetscape shown in Appendix 5-2B [*Jasper Place Opportunity Area Streetscape Drawings*] of this Schedule from the east side of 156 Street into the Orange Hub courtyard fronting 156 Street.
- F. Notwithstanding Appendix 5-2B [*Jasper Place Opportunity Area Streetscape Drawings*], all street furniture, trees, lighting columns, signage and any other above-ground appurtenances on Stony Plain Road between 156 Street and 151 Street shall be located within the Roadway right of way. They are not permitted within the URW portion of the City Lands.

Section 2-5 – NOT USED

Section 2-6 – LIGHTING

2-6.1 GENERAL

- A. Lighting for major Structures, including Stations, Stops, Utility Complexes, Maintenance and Storage Facilities and Elevated Guideways, shall be integrated with the architectural and structural systems.
- B. Architectural accent lighting shall highlight architectural, interior design and Public Art features, provide a sense of welcoming, and illuminate public spaces and shall make use of complementary colours.
- C. Lighting designed for illuminating Passenger information shall be:
 - 1. visually organized and integrated with wall or ceiling treatments;
 - 2. selected to achieve optimal colour accuracy; and
 - 3. concealed from Public View.
- D. The point-by-point method, utilizing computer generated calculations, shall be used to validate illumination levels and boundaries.
 - 1. The software used shall follow IESNA procedures. Calculation results shall include maximum, minimum, and average illumination levels along with the uniformity ratios and lighting power densities in accordance with ASHRAE 90.1.
 - 2. Calculations shall also include luminaire locations, mounting heights, wattage, lumens, color rendering index, color temperature, reflectance values, light loss factors, and photometric file used.

2-6.2 RIGHT OF WAY LIGHTING

- A. This Section 2-6.2 [*Right of Way Lighting*] sets out the requirements for lighting along Roadways, Elevated Guideways, SUPs, and sidewalks throughout the Lands as required by Section 3-7 [*Street Lighting Requirements*] of this Schedule.
- B. Lighting in the Downtown Opportunity Area and Jasper Place Opportunity Area shall comply with the requirements in Section 2-4.7B.3 [*Downtown Opportunity Area Special Requirements*] and Section 2-4.8.B.2 [*Jasper Place Opportunity Area Special Requirements*] of this Schedule, respectively.
- C. All luminaires shall be LED.
- D. Except as otherwise specified in this Schedule, all light poles and all related lighting components, including luminaires, pole bases and breakaway bases, coat finishes, lighting control cabinets, lighting controller bases, photo cells, receptacles, and surge suppression shall comply with the *Valley Line West Road and Walkway Lighting Construction and Materials Standards*.
- E. Where shared-use poles “Type 1”, “Type 2”, or “Type 3” are used, pursuant to Table 2-9.8 [*OCS Pole Requirements*] of this Schedule, all in-fill Roadway and pedestrian lighting shall:
 - 1. be provided with poles that are consistent in shape, colour and texture with the applicable shared-use pole; with pedestrian light poles having a constant diameter not exceeding 150 mm; and
 - 2. include LED luminaires, lighting control cabinets, lighting controller bases, photo cells, receptacles, and surge suppression that comply with the *Valley Line West Road and Walkway Lighting Construction and Materials Standards*.
- F. Light standards along SUPs shall be installed with a clear distance of nominally 600 mm between the light pole and the edge of the SUP.

- G. Do not provide walkway light standards for SUPs lit by Roadway light standards, unless required illuminance cannot be achieved without additional walkway light standards.
- H. Lighting of the SUP and the sidewalk of the Stony Plain Road Bridge shall be achieved by means of LED lighting integrated with the Protection Railings.
- I. Provide lighting on all Elevated Guideways with illumination for safe evacuation of Passengers in case of an emergency, if required by the Safety and Security Certification Program:
 - 1. lighting shall be integrated into the Structures and shall not be surface mounted;
 - 2. if a box section is used for the 87 Avenue Elevated Guideway, lighting shall be incorporated into the curbs as schematically shown in Figure 2-4.5.3.3 [*LRV Collision Barrier*]; and
 - 3. if a trough girder is used for the 87 Avenue Elevated Guideway, lighting shall be incorporated into the webs.
- J. Maintain uniform spacing and luminance where lighting is provided on both sides of the Roadway.
- K. Provide the following maintained illuminance levels at ground level of PPZs and throughout the Under Guideway Landscape Area, as described in Section 2-14.6.5 [*Under Guideway Landscape Area Special Requirements*] of this Schedule, and place luminaires such that light trespass onto adjacent private properties is minimized:
 - 1. minimum average horizontal of 20 lux, with a uniformity ratio of 4:1 (average to minimum); and
 - 2. minimum average vertical of 10 lux.
- L. The Jasper Place Opportunity Area shall be designed to include the electrical systems required for secondary lighting to street tree beds so that the City can re-establish the existing tree lighting, as described in Section 6-6-.3.2 [*Jasper Place Opportunity Area Specific Requirements*] of this Schedule.

2-6.3 FACILITY LIGHTING

- A. This Section 2-6.3 [*Facility Lighting*] sets out the requirements for lighting at Stops, Stations and Maintenance and Storage Facilities.
- B. Lighting for Stops and Stations shall be visually integrated with Canopy structures and associated ceiling treatments at a consistent datum that implies a continuous visual surface and conceals the lighting infrastructure. All lighting systems shall be coordinated with architectural, landscaping, and signage designs.
- C. Lighting fixture colour rendering temperature shall be consistent throughout the Infrastructure in accordance with the Valley Line West LRT Facilities Design and Construction Standards.
- D. Lighting fixture Colour Rendering Index (CRI) shall be consistent throughout the Infrastructure in accordance with the Valley Line West LRT Facilities Design and Construction Standards.
- E. Lighting levels for facilities shall define and differentiate between task areas, decision and transition points, Platform edges and areas of potential hazard. Lighting design shall minimize glare and provide uniform distribution of illumination. Luminaires shall be selected, located, and aimed to accomplish their primary purpose while producing a minimum of objectionable glare and interference with task accuracy, vehicular traffic, and neighbouring areas.
- F. Provide maintained horizontal illuminance levels at Stations meeting the criteria listed in Table 2-6.3 [*Maintained Horizontal Illuminance Levels for Interior Spaces at Stations*].

Table 2-6.3: Maintained Horizontal Illuminance Levels for Interior Spaces at Stations

Location	Minimum Average (Lux)	Uniformity (Ave./Min.)	Emergency (Lux)
All Areas not Identified Below	200	3 : 1	10
Ticket/Information Kiosk	300	2.5 : 1	10
Stairs, sloped walkways, accessibility ramps, Escalators	200	2 : 1	10
Designated Waiting Areas	220	3 : 1	10
Washrooms	300	3 : 1	10

- G. Provide maintained horizontal illuminance levels at Maintenance and Storage Facilities in accordance with Section 8-2.4B *[General Requirements]* and Section 8-3.4B *[General Requirements]* of this Schedule.
- H. Lightning protection systems meeting the requirements of CAN/CSA-B72 Installation Code for Lightning Protection Systems shall be visually integrated into the roof Canopies of the Stations.
- I. Notwithstanding Section 2-6.2K.1 *[Right of Way Lighting]* of this Schedule, the maintained minimum average horizontal illuminance at ground level of Stations, Stop Platforms, and at bicycle parking locations shall be 30 lux.

2-6.4 WEM TRANSIT CENTRE AND LEWIS FARMS PARK AND RIDE LIGHTING

- A. This Section 2-6.4 *[WEM Transit Centre and Lewis Farms Park and Ride Lighting]* sets out the requirements for lighting at the WEM Transit Centre and Lewis Farms Park and Ride as required by Section 3-7 *[Street Lighting Requirements]* of this Schedule.
- B. Locate luminaires in parking areas to reduce shadows between rows of automobiles.
- C. Provide automatic lighting control devices capable of reducing light levels or being shut off, based on pre-set schedules, occupancy sensors or available measured daylight.
- D. Energize all lighting with Utility fed 600/347V AC, or 208/120V AC, 3 phase, 4 wire, 60 Hz.
- E. Lighting fixtures shall be LED type with minimum IP65 rating.

Section 2-7– PUBLIC ART

- A. Except as noted in Section 2-71 *[Public Art]*, the City will procure, supply, and install all Public Art for the Project.
1. Project Co shall design and construct all required foundations and supports, including embedded plates, hanging points and connections, for Public Art that is not integral to the artwork.
- B. Public Art meeting the descriptions provided in Table 2-7 *[Public Art]*, and more specifically described in the applicable Draft Public Art Calls, shall be integrated into the Project at the locations described in Table 2-7 *[Public Art]*.

Table 2-7: Public Art

Location	Opportunities	Draft Public Art Call Reference	Art Installation or Delivery	Earliest Installation or Delivery after Submission of the Public Art Integration Schedule	Minimum Art Installation or Delivery Window ^(Note 1)	Concept Design Provided by City at the Latest Before Start of Art Installation or Delivery Window	Early Art Call Release ^(Note 2)	Power Required for Art (lighting, digital displays, etc.) ^(Note 3)
Stony Plain Road Bridge	Inset into pedestrian sidewalk concrete AND/OR Post-applied Platform concrete slab finishes AND/OR Integrated into pedestrian guardrails	Stony Plain Road Bridge	Delivery Installation Installation	30 months	14 days 30 days 30 days	23 months	No	No
WEM Station	Opportunities selected by artist: Artwork integrated into the south glazing of the L3 Platform Level AND Artwork painted onto the south facing solar shade screen AND Two pre-existing, exterior, wall-mounted Public Art pieces from the WEM transit centre (Thing 1 & Thing 2) to be reinstalled inside the heated waiting area of the WEM Station at the L1 Ground Level	West Edmonton Mall Station	Delivery Installation	30 months	14 days 75 days	23 months	Yes	No

Location	Opportunities	Draft Public Art Call Reference	Art Installation or Delivery	Earliest Installation or Delivery after Submission of the Public Art Integration Schedule	Minimum Art Installation or Delivery Window ^(Note 1)	Concept Design Provided by City at the Latest Before Start of Art Installation or Delivery Window	Early Art Call Release ^(Note 2)	Power Required for Art (lighting, digital displays, etc.) ^(Note 3)
Misericordia Station	Opportunities selected by artist: Stand-alone artwork(s) on the L1 Ground Level AND Replacement of various interior fixtures and furnishings (e.g. door handles, handrails, seating) with tactile versions	Misericordia Station	Installation	30 months	30 days	23 months	Yes	Yes
	Installation		30 days		No			
87 Avenue Elevated Guideway Ramp at Aldergrove Park	Integrated concrete relief design onto the sides of the Elevated Guideway Ramp	87 Avenue Elevated Guideway Ramp at 164 Street and Aldergrove Park	Delivery	30 months	14 days	23 months	Yes	No
87 Avenue Elevated Guideway Ramp at 164 Street	Integrated concrete relief design onto the sides of the Elevated Guideway Ramp	87 Avenue Elevated Guideway Ramp at 164 Street and Aldergrove Park	Delivery	30 months	14 days	23 months	Yes	No
Lewis Farms Stop	At each Stop, either:	14 Stops- Discoveries	Installation	24 months	30 days	18 months	No	No
Aldergrove/ Belmead Stop	Lightweight stand-alone artwork(s) on the Platform(s) OR Inset into Platform concrete							
Meadowlark Stop	OR Lightweight, low-relief artwork Inset into Shelter glazing frames		Installation		30 days			
Glenwood/ Sherwood Stop	OR Art post-applied to shelter glass		Installation		30 days			
Jasper Place Stop	OR							
Stony Plain Road/149 St. Stop								
Grovenor/ 142 St. Stop								

Location	Opportunities	Draft Public Art Call Reference	Art Installation or Delivery	Earliest Installation or Delivery after Submission of the Public Art Integration Schedule	Minimum Art Installation or Delivery Window ^(Note 1)	Concept Design Provided by City at the Latest Before Start of Art Installation or Delivery Window	Early Art Call Release ^(Note 2)	Power Required for Art (lighting, digital displays, etc.) ^(Note 3)
Glenora Stop	Post-applied Platform concrete slab finishes OR Decorative elements attached to Canopies		Installation		30 days			
124 Street Stop			Installation		30 days			
Brewery/120 St. Stop								
The Yards/116 St. Stop								
MacEwan Arts/112 St. Stop								
NorQuest Stop								
Alex Decoteau Stop								
Lewis Farms Storage Facility	Artwork attached to the east and south facing walls of facility	Lewis Farms Storage Facility	Installation	30 months	30 days	23 months	No	Yes
Every Above Ground Utility Complex	Art panel(s) attached to most prominent perimeter wall of all above-grade Utility Complexes	Utility Complex Murals	Installation	20 months	30 days	14 months	No	No
Gerry Wright OMF Building B	Artwork attached to the Southeast surface that faces Whitemud Drive	Gerry Wright Operations and Maintenance Facility Building	Installation	30 months	30 days	23 months	No	Yes

Notes:

1: The “Minimum Art Installation or Delivery Window” describes the minimum continuous period to be allocated to the City in each Public Art Integration Schedule for the City to install the Public Art or to deliver the Public Art information to Project Co. The column titled “Art Installation or Delivery” in Table 2-7 [*Public Art*] outlines whether the window is an art installation window or an art delivery window for each Public Art opportunity.

2: Public Art opportunities designated for early art call release were released in March 2020 and artists were engaged by the City in May 2020. Draft concept designs have been provided to the City; refer to Appendix 1 of the applicable Draft Public Art Calls for additional information.

3: Power supply shall be provided by Project Co.

- C. Design and construct the Infrastructure such that it can be safely operated (this includes not blocking camera angles), in compliance with all other requirements set out in this Schedule and the Operability and Maintainability Parameters, notwithstanding:
1. any delay in delivery, damage to, incompatibility of, or other unavailability of, any Public Art; and
 2. vandalism or other damage to any Public Art, requiring removal and repair or replacement thereof.
- D. Design the Infrastructure such that any Public Art can be readily accessed, maintained and removed without adverse impact to the availability of the Infrastructure.
- E. Protect against damage from the environment and vandalism, any completed Public Art from the time that is delivered in place to the time it is turned over to the City at the Construction Completion Date.
- F. The City will manage and administer its Public Art contracts and manage:
1. all communications with the artists; and
 2. the scheduling of installation and delivery of the Public Art in accordance with Section 6 [*Public Art Integration Schedule*] of Schedule 3 [*Construction Schedule*] and Table 2-7 [*Public Art*].
- G. The City will provide Project Co with a concept design for each work of Public Art. The concept design will:
1. be provided for the applicable work of Public Art no later than the number of months specified in the column titled "Concept Design Provided by City at the Latest Before Start of Art Installation or Delivery Window" in Table 2-7 [*Public Art*]; and
 2. include all the information required to be submitted by the City as set out in the applicable Draft Public Art Call.
- H. Provide two interior wall spaces, in accordance with Section 5-2.10.3C [*General Station Requirements*] of this Schedule, at the L1 Ground level of WEM Station to accommodate the two (2) existing pieces of Public Art from the existing WEM transit centre (Thing 1 & Thing 2), de-constructed and transported in accordance with Section 1-7.5.4 [*Special Items*] of this Schedule and:
1. transport the Public Art pieces from the Edmonton Arts Council storage facility located at 11470 156 Street to the WEM Station such that the materials and components are not damaged during the transportation; and
 2. re-install the Public Art pieces in the accepted spaces under the supervision of the City.
- I. Project Co shall be responsible for:
1. the procurement, fabrication and installation of the following Public Art:
 - a. the precast panels with integrated Public Art concrete relief design at the 87 Avenue Elevated Guideway Ramps at Aldergrove Park and 164 Street; and

- b. the art glazing at the L3 Platform Level of the south side of the WEM Station;
- 2. the procurement and fabrication of the following Public Art:
 - a. south facing solar shade screen at the WEM Station, which shall be painted and finished by the City in accordance with Section 2-7P [*Public Art*] of this Schedule; and
- 3. The installation of the following Public Art:
 - a. any art required to be integrated into the pedestrian sidewalk concrete of the Stony Plain Road Bridge; and
 - b. any art required to be integrated into the Platform concrete slabs of Stops.
- J. Notwithstanding Section 2-7I [*Public Art*] of this Schedule, Project Co may proceed with the fabrication and installation of standard infrastructure if the information for the applicable Public Art that is to be applied to the elements has not been provided by the City to Project Co by the end date of the art delivery window as specified in the applicable Public Art Integration Schedule.
- K. For Public Art installed by the City, provide the City with unimpeded and uninterrupted access to the relevant Infrastructure for the Public Art installation window of the applicable Public Art installation as set out in the Public Art Integration Schedule.
- L. Upon reasonable request, Project Co's Public Art Lead and other relevant Project Co Persons shall meet with the City's Representative and other City Persons to coordinate the design, installation and integration of the Public Art into the Infrastructure and open spaces. This includes but is not limited to site meetings.
- M. To the extent necessary to facilitate the proper integration of Public Art into the Project, Project Co shall, upon reasonable request, provide the City with:
 - 1. access to electronic dwg format files showing the then current state of applicable designs;
 - 2. specifications of materials that Public Art is attached to;
 - 3. access parameters for Public Art locations; and
 - 4. any other information required by the City to provide the Public Art.
- N. Project Co shall submit to the City within sixty (60) days of the Submission of each Public Art Integration Schedule in accordance with Section 6 [*Public Art Integration Schedule*] of Schedule 3 [*Construction Schedule*] or a longer period as accepted by the City:
 - 1. all the drawings and images included in the applicable Draft Public Art Call, updated to reflect Project Co's design, in pdf or jpg format; and
 - 2. any updates to the text in the applicable Draft Public Art Call, reflecting Project Co's design.
- O. Project Co shall deconstruct, transport, store and reinstall an Alberta Foundation for the Arts Public Art piece currently located on Misericordia lands in accordance with Section 1-7.5.4 [*Special Items*] of this Schedule.
- P. Project Co shall prepare and submit the following Public Art mock-ups at least ninety (90) days prior to the start of the fabrication of the applicable elements, where mock-ups Accepted by the City may be used for Construction:
 - 1. two (2) full width (width) x 3 m (height) precast concrete panels with integrated Public Art for the 87 Avenue Elevated Guideway Ramp at Aldergrove Park;

2. one (1) full width (width) x 3 m (height) precast concrete panel with integrated Public Art for the south side of the 87 Avenue Elevated Guideway Ramp at 164 Street;
 3. one (1) full width (width) x 3 m (height) precast concrete panel with integrated Public Art for the north side of the 87 Avenue Elevated Guideway Ramp at 164 Street; and
 4. one (1) full width (width) x full height (height) glazing unit with integrated Public Art for the L3 Platform Level of WEM Station.
- Q. Throughout the applicable art installation window, Project Co shall provide an interior, temperature controlled, ventilated location within City of Edmonton limits for the City to apply a painted mural and finish coat to the south solar shade screen of the WEM Station.
1. Project Co shall deliver the solar shade screen, which shall be primed and have one intermediate coat, to the designated location and place it such that it is fully supported to prevent damage and allows convenient access to the entirety of the outside, south facing, face. The solar shade screen may be delivered fully assembled or in segments.
 2. Project Co shall conceal any attachment areas of the solar shade screen that should not receive any paint or finish coat such that they remain protected from coating.
 3. Once the solar shade screen painting has been finished by the City, all required transportation of the art piece(s) shall be carried out by a transport company experienced in movement of large-scale fine art pieces.
 4. Project Co shall install the painted solar shade screen onto the WEM Station.
- R. Project Co shall notify the City of any damage to Public Art for which Project Co is responsible to transport and install and which occurs during transport or installation within eight (8) hours of discovery.
1. No attempt shall be made by Project Co to repair any such damage to Public Art.
 2. Any such damage will be assessed and repaired by the City.
 3. Project Co shall be responsible for any costs incurred by the City in performing any such repairs. Project Co shall pay such costs upon receipt of an invoice from the City.

Section 2-8 – BRANDING

Project Co shall utilize the unique Valley Line LRT specific branding developed for Valley Line LRT Stage 1, which includes applications on elements such as the Stops and Stations and the Gerry Wright OMF Building A.

Section 2-9– SUPPORT SYSTEMS

2-9.1 GENERAL

- A. This Section 2-9 [*Support Systems*] sets out the SUI requirements for all Support Systems exposed to Public View.
- B. All Support Systems shall be:
 - 1. visually integrated into the overall design; and
 - 2. placed to maximize pedestrian flow and accessibility.

2-9.2 ELECTRICAL BOXES

- A. Electrical boxes, such as outlet, pull, or junction boxes, shall be flush mounted and their form, location and colour shall be integrated into the architecture of the surface they are mounted to.

2-9.3 CONDUIT AND CABLES

- A. All conduit, cables and ductwork at Stops, Stations, any shelters, Utility Complex screening walls, and Transportation Structures shall be concealed within structural elements or behind wall and ceiling finishes, except that:
 - 1. conduit, cables and ductwork for the Anthony Henday Drive LRT Bridge need not be concealed within structural elements if a concrete trough girder superstructure is used, provided that the conduit, cables and ductwork remain not exposed to Public View.

2-9.4 WAYSIDE EQUIPMENT ENCLOSURES

- A. Wayside Equipment Enclosures shall be designed to integrate into the site context and the Character Zone they are located in.
- B. Wayside Equipment Enclosures located on the ground shall be treated with a graphic wrap or screened by landscaping.
- C. Wayside Equipment Enclosures not located on the ground shall be co-located on poles with other equipment, such as signals, and their conduits and cables shall not be exposed to Public View.
- D. Infill poles to support Wayside Equipment Enclosures are not permitted.
- E. Wayside Equipment Enclosures shall co-locate as many system components as possible to minimize the number of discrete enclosures.

2-9.5 DUCT BANKS

- A. Duct banks shall not be exposed to Public View, except that:
 - 1. a duct bank is permitted underneath the deck of the Stony Plain Road Bridge, which may be visible from Groat Road below; the duct bank shall be installed between girders as close as possible to the deck soffit and shall not extend below the soffit of the bridge girders at any point.

2-9.6 DRAINAGE

- A. Longitudinal drainage pipes mounted to Structures and exposed to Public View are not permitted.
- B. Drainage up to a 1:5 year storm event shall not outfall onto or drain at-grade across any pedestrian areas.

- C. Drains on Elevated Guideways shall be hidden from view from ground level and shall receive a finish that causes them to blend into the structure when viewed from the Elevated Guideway.
- D. Drainage downspouts shall be concealed by means of:
 1. recesses set back into the smaller width dimension at the face of concrete piers or columns, such that drain pipes are concealed when the pier/column is viewed when looking along the long axis of the superstructure; the colour of the downspouts shall be consistent with the colour of the concrete at the applicable pier/column; or
 2. running through hollow section columns.
- E. Drainage elements, such as gutters, eaves troughs and rainwater leaders, shall be concealed or integrated into the overall design of the structure on which they are installed.

2-9.7 STANDPIPES

- A. Standpipes, where required on Elevated Guideways, shall be concealed by means of:
 1. recesses set back into the smaller width dimension at the face of concrete pier columns, such that standpipes are concealed when the column is viewed when looking along the long axis of the superstructure; and
 2. running standpipes longitudinally within the void of the superstructure box girder or visually integrated along the top deck of the trough girder.
- B. Standpipes for the Stations shall be concealed by means of utility chaseways, except where access to the standpipe is required by code.

2-9.8 OVERHEAD CATENARY SYSTEM

- A. OCS shall comply with the requirements set out in this Section 2-9.8 [*Overhead Catenary System*].
- B. OCS in the Downtown Opportunity Area and Jasper Place Opportunity Area shall also adhere to the requirements in Section 2-4.7B.3 [*Downtown Opportunity Area Special Requirements*] and Section 2-4-8B.2 [*Jasper Place Opportunity Area Special Requirements*] of this Schedule, respectively.
- C. All OCS structures and associated equipment shall be of lightweight mechanical and structural design.
 1. The OCS shall comply with Section 6-3.3.2 [*Overhead Catenary System Configuration*] of this Schedule. Where additional electrical reinforcing cabling is required, it shall be provided by means of parallel underground feeders.
- D. Notwithstanding the requirements in Section 2-4.7B.3 [*Downtown Opportunity Area Special Requirements*] of this Schedule, OCS poles shall be mounted between the Tracks, except for Tracks not on Elevated Guideways where clearance constraints do not permit installation between the Tracks. Where installation between the Tracks is not possible due to clearance constraints, OCS poles shall be side mounted.
- E. Where OCS poles are side mounted, they shall be combined with any required lighting and Traffic Signal poles.
- F. Where OCS poles are combined with lighting, spacing between poles shall be optimized with the lighting and catenary design. Infill lighting poles will only be accepted by the City if Project Co can demonstrate to the City, acting reasonably, that lighting levels in pedestrian areas and the Roadways cannot be achieved, as required for the lighting design, solely through the use of shared use poles.

- G. Except for wires spanning between two poles, all wires, services, conduits, cables, and balance-weights shall be internally concealed in poles and support arms.
- H. Subject to Section 4 [*Land Matters*] of the Agreement, building fixings may be used instead of poles to reduce street clutter.
- I. OCS poles shall be free standing, and shall not use a guy wire and foundation unless otherwise Accepted by the City.
- J. The spacing of OCS poles on Elevated Guideways shall be:
 - 1. coordinated such that the nearest OCS pole to a pier or abutment aligns nominally with that pier or abutment when viewed in elevation; and
 - 2. distributed symmetrically between two piers or a pier and an abutment, i.e., at mid-span (for one pole per span), or two poles at the third points of a span (for two poles per span).
- K. OCS poles shall be one of the following four types:
 - 1. **Type 1: Typical Urban Shared-use Pole** – all centre-mounted OCS poles for use along the LRT corridor, except where Type 2, Type 3, or Type 4 poles are used;
 - 2. **Type 2: Jasper Place Shared-use Pole** – all centre-mounted and side-mounted OCS poles for use in the Jasper Place Opportunity Area;
 - 3. **Type 3: Downtown Shared-use Pole** – all centre-mounted and side-mounted OCS poles for use in the Downtown Opportunity Area; and
 - 4. **Type 4: Non-Shared-use Pole** – all centre-mounted OCS poles for use along 87 Avenue (except east of the east 87 Avenue Elevated Guideway ramp) and Webber Greens Drive, including the above grade section of trackway and the Anthony Henday Drive Bridge and all side-mounted OCS poles for use outside the Downtown Opportunity Area and Jasper Place Opportunity Area.
- L. The features of each OCS pole type shall be as described in Table 2-9.8 [*OCS Pole Requirements*].

Table 2-9.8: OCS Pole Requirements

OCS Type	Pole Height	Street Lighting	Pedestrian Lighting	Pole Cap	Neighborhood Banner Support
Type 1: Typical Urban Shared-use Pole (centre-mounted)	shared-use	included	not applicable	Standard Dome	not required
Type 2: Jasper Place Shared-Use Pole (centre-mounted or side-mounted)	shared-use	included	included (if required)	Custom	not required
Type 3: Downtown Shared-Use Pole (centre-mounted or side-mounted)	shared-use	included	included (if required)	Custom	required
Type 4: Non-Shared-Use Pole (centre-mounted or side-mounted)	typical	not applicable	not applicable	Standard Dome	not required

M. All OCS poles shall:

1. be plain galvanized closed steel sections;
2. be of circular cross-section;
3. be a maximum of 410 mm in diameter;
4. have a taper from ground up resulting in a reduction in radius of nominally 6 mm per metre, except for balance weight anchor poles, which may be straight;
5. have either a typical or shared-use pole height as follows:
 - a. the typical pole height shall be as functionally required for center-running OCS support arms; and
 - b. the shared-use pole height shall be as functionally required by OCS, lighting, and Traffic Signal pole requirements, with all poles of the shared-use type within an Opportunity Area having the same height; and
6. where they are shared-use, have luminaires and horizontal luminaire supports with similar styling matching with the appearance of those constructed on Valley Line LRT Stage 1.

- N. Pole access panels shall be a minimum of 290 mm by 120 mm and shall be located near the base of the pole and with the bottom of the access panel not being higher than 300 mm from the base of the pole.
- O. Where the OCS pole is surrounded by hardscaping, such as sidewalks and Platforms, the top of the pole foundations shall be:
 - 1. within +/- 5 mm of the level of the surrounding hardscaping anywhere around the pole foundation;
 - 2. at least 125 mm above the surrounding hardscaping anywhere around the pole foundation; or
 - 3. sufficiently recessed so that hardscaping extends to the pole base and:
 - a. no cracks or ledges occur in the hardscaping;
 - b. differential long-term settlements within 1 m of the pole are smaller than 5 mm; and
 - c. water is effectively drained from the top of the pole foundation.
- P. OCS poles shall have either a standard dome or a custom pole cap, as specified in Table 2-9.8 [*OCS Pole Requirements*].
- Q. OCS pole caps shall be as shown in Figure 2-9.8 [*OCS Pole Architectural Features*].
- R. OCS pole caps shall match the material, colour, and finish of the OCS pole.
- S. OCS support arms shall match the colour, and finish of the OCS pole and be the same across the Infrastructure, matching the appearance of the OCS support arms constructed for Valley Line LRT Stage 1 as illustrated in the Valley Line West LRT Design Guide.

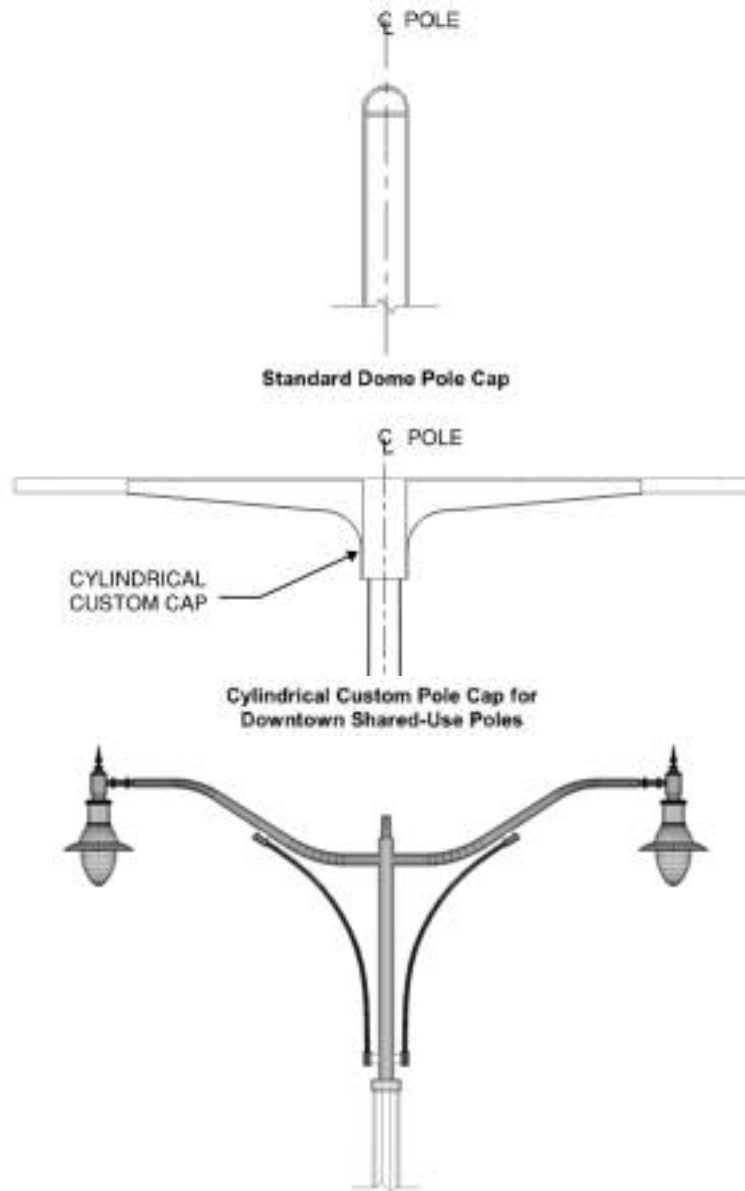

Custom pole caps for Jasper Place Opportunity Area

Figure 2-9.8: OCS Pole Architectural Features

- T. OCS protection screening, where demonstrated to be necessary by the Safety and Security Certification Program, shall be visually light, simple, and integrate aesthetically with the Structure to which the screening is affixed.
- U. Jasper Place Opportunity Area OCS pole caps shall be reasonably sized to be similar to the existing pole caps and shall have an overall aspect ratio proportion similar to Figure 2-9.8 [OCS Pole Architectural Features].
- V. OCS pole base covers are not permitted.
- W. Where breakaway connections are used for OCS pole bases, the gap between the underside of the OCS pole baseplate and the top of the OCS pole foundation shall be minimized and shall be

concealed with a continuous galvanized metal skirt that projects downwards perpendicularly from the edges of the OCS pole baseplate and that shall:

1. be a minimum of 3mm in thickness; and
2. match the material, colour and finish of the OCS pole.

2-9.9 UTILITY COMPLEXES

- A. This Section 2-9.9 [*Utility Complexes*] sets out the SU1 requirements for Utility Complexes.
- B. Utility Complexes shall be provided with perimeter walls on all sides of the Utility Complex to ensure their integration with the applicable Character Zone and Opportunity Area, as illustrated in the Valley Line West LRT Design Guide.
- C. Utility Complex perimeter walls shall:
1. have maximum outside dimensions of either 30.0 m by 10.2 m or 21.6 m by 15.5 m, except for the 89 Avenue/Meadowlark Road Utility Complex whose dimensions shall be in accordance with the setback criteria shown in Appendix 5-1A [*Project Description Drawings*] of this Schedule;
 2. extend a minimum of 600 mm above the highest point of all Infrastructure within the perimeter walls;
 3. be of a constant height along the entire perimeter, except for the 107 Street and 104 Avenue Utility Complex, the Oliver Square Utility Complex, and the 87 Avenue and 165 Street Utility Complex, which shall have varying perimeter wall heights for added visual interest;
 4. be positioned to minimize the Utility Complex's visual presence; and
 5. be setback from neighbouring property lines shown in Appendix 5-1A [*Project Description Drawings*] of this Schedule.
- D. All Utility Complex perimeter walls shall have an exterior cladding of brick, except:
1. the 107 Street and 104 Avenue Utility Complex exterior cladding shall incorporate brick, metal panel and stucco and/or precast concrete to integrate with the surrounding structures;
 2. the Oliver Square Utility Complex exterior cladding shall incorporate brick with a precast concrete and Tyndall stone base that nominally matches the precast concrete and Tyndall stone bases that are typical to the building structures within the Edmonton Brewery District (north of 104 Avenue from 118 Street to 121 Street); and
 3. the 87 Avenue and 165 Street Utility Complex exterior cladding shall incorporate brick, metal panel, precast concrete, and decorative metal louvres to integrate with the design of the Misericordia Station.
- E. The colour and overall design language of the Utility Complex perimeter wall exterior cladding shall be selected to integrate with the adjacent infrastructure and into the applicable Character Zone and Opportunity Area.
1. The colour of the perimeter wall brick exterior cladding for the Oliver Square Utility Complex shall nominally match the colour of the brick cladding typically used within the Edmonton Brewery District (north of 104 Avenue from 118 Street to 121 Street).

- F. Openings in Utility Complex perimeter walls, such as doors, shall have a wood finish on the publicly visible face; the colour of the wood finish shall be selected to integrate with the exterior cladding colour and the surrounding area.
 - 1. The wood finish for the Oliver Square Utility Complex shall be charcoal grey, nominally matching the charcoal grey trims typically used within the Edmonton Brewery District (north of 104 Avenue from 118 Street to 121 Street).
- G. Driveway accesses and the number of Parking stalls of dimension 3.0 m x 5.5 m shall be provided as shown in Appendix 5-1A [*Project Description Drawings*] of this Schedule.
- H. All driveway accesses shall be a maximum 5.0 m wide, except the 87 Avenue/165 Street Utility Complex which shall be a maximum of 5.9 m wide and the 144 Street Utility Complex access which shall be provided as shown in Appendix 5-1A [*Project Description Drawings*] of this Schedule.
- I. Utility Complex site landscaping shall be provided as described in Section 2-14.12 [*Utility Complex Site Landscaping*] of this Schedule and shall provide a space for landscaping screening a minimum of 2.0 m wide between parking spaces and the Utility Complex perimeter wall as shown in Appendix 5-1A [*Project Description Drawings*] of this Schedule.

2-9.10 VEHICLE ARRESTORS

- A. Where vehicle arrestors are required pursuant to Section 3-1.3.7 [*Vehicle Overrun Protection*] of this Schedule, each shall respond to, and be integrated with, the site context and the Character Zone, as illustrated in the Valley Line West LRT Design Guide.

Section 2-10 – STOPS AND STATIONS

2-10.1 INTRODUCTION

- A. Section 2-10.2 [*General Stop and Station Integration*] of this Schedule sets out the general SUI requirements applicable to all Stops and Stations, including the design elements that may be varied between Stops. Section 2-10.3 [*Stop Specific Requirements*] of this Schedule sets out additional SUI requirements that are specific to individual Stops and Stations.

2-10.2 GENERAL STOP AND STATION INTEGRATION

2-10.2.1 Design Context

- A. The Stops and Stations, are the primary interfaces between the public and the Infrastructure. Accordingly, each Stop and Station shall be designed to optimize the user experience and integrate into its urban context, such that it presents a positive contribution to the built environment for Passengers, as well as neighbours, and passersby.
- B. As further specified in this Section 2-10.2 [*General Stop and Station Integration*], each Stop and Station shall:
1. be “pedestrian first” and include intuitive wayfinding and provisions for a comfortable user experience, considering Edmonton’s winter climate;
 2. include the Canopy type specified in Table 2-10.2.3 [*Stop PI Theme and Canopy Type for each Stop and Station*];
 3. include customized Platform elements to provide a coordinated Stop aesthetic in order to express the applicable Stop PI Theme set out in Table 2-10.2.3 [*Stop PI Theme and Canopy Type for each Stop and Station*];
 4. comply with SUI Principles;
 5. achieve a coherent and uncluttered appearance through the integration of all Infrastructure, including signage and Passenger Interface Equipment, into the fewest possible visible elements;
 6. have a composed and tightly coordinated arrangement of all Platform elements;
 7. have elements, such as stairs, escalators, seating, Ticket Vending Machines and waste and recycling receptacles, placed in locations that direct and aid Passengers in accessing and travelling through the Stop or Station;
 8. be located as shown in Appendix 5-1A [*Project Description Drawings*] of this Schedule; and
- C. The Stop PI Themes are as follows:
1. **Park-Like:** Home to natural features such as parks, trails, SUPs and other recreational amenities, these areas tend to be dominated by landscaping, with low-density residential developments set back from the street, thus contributing to the park-like setting. Park-Like design shall be consistent with the naturalistic and rustic character of the area.
 2. **Historic:** Characterized by early 20th century neighbourhoods with mainly single detached homes. The initial building typology and grid layout inherent to these neighbourhoods has strongly influenced the subsequent development of an assortment of other historic buildings and destinations. Historic design shall complement the existing traditional character of the area.

3. **Contemporary:** Characterized by high-density and a mix of uses and given their location, Contemporary Stops and Stations will experience higher levels of regular usage and activity. Contemporary design shall reflect a modern high-use setting.

2-10.2.2 Design Constants and Variables

- A. The design of each Stop and Station shall include a combination of elements that are constant across all Stops and Stations, and elements that are customized to reflect the relevant Stop PI Theme. Only the elements set out in Section 5-2.3 [*Stop Design Variables*] of this Schedule may be varied between Stops. Design variable Stop elements as follows:
 1. varying all elements identified as variable is not compulsory; however, Stop PI Theme-responsive design variation is required;
 2. Stop PI Themes shall be clearly differentiated from one another;
 3. all Stops with the same Stop PI Theme shall be similar, and identifiable as being of the same Stop PI Theme; and
 4. all variable Stop elements within the same Stop shall be consistent.

2-10.2.3 Canopies

- A. Each Platform shall include Canopies meeting the requirements of Section 5-2.6.6 [*Canopies*] of this Schedule.
- B. Stop Canopies shall be of either “Urban” or “Neighbourhood” style and Station Canopies shall be “special case”, as specified in Table 2-10.2.3 [*Stop PI Theme and Canopy Type for each Stop and Station*].

Table 2-10.2.3: Stop PI Theme and Canopy Type for each Stop and Station

Stop/Station	Stop PI Theme	Canopy Type
Lewis Farms Stop	Park-Like	Neighbourhood
Aldergrove/Belmead Stop	Park-Like	Neighbourhood
WEM Station	Contemporary	Special case
Misericordia Station	Park-Like	Special case
Meadowlark Stop	Park-Like	Neighbourhood
Glenwood/Sherwood Stop	Park-Like	Neighbourhood
Jasper Place Stop	Park-Like	Neighbourhood
Stony Plain Road/149 St. Stop	Park-Like	Neighbourhood
Grovenor/142 St. Stop	Park-Like	Neighbourhood
Glenora Stop	Historic	Neighbourhood
124 Street	Historic	Neighbourhood

Stop/Station	Stop PI Theme	Canopy Type
Brewery/120 St. Stop	Contemporary	Urban
The Yards/116 St. Stop	Contemporary	Urban
MacEwan Arts/112 St. Stop	Contemporary	Urban
NorQuest Stop	Contemporary	Urban
Alex Decoteau Stop	Contemporary	Urban

C. The indicative profile of each Stop Canopy type is shown in Figure 2-10.2.3 [Stop Canopies].

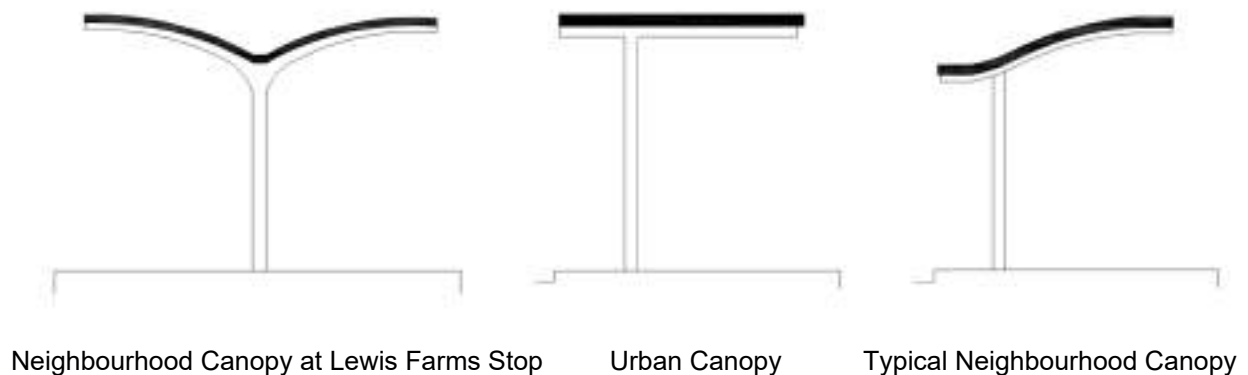

Figure 2-10.2.3: Stop Canopies

D. All Stop Canopies shall:

1. be supported by a single row of steel columns spaced at a minimum of 3000 mm on centre, with cantilevering steel beams at each column location:
 - a. the Lewis Farms Stop Canopies shall be nominally aligned with the midpoint of the short plan dimension of the Platform. A single, non-spliced steel beam shall be cantilevered symmetrically to either side at each column location; and
 - b. Canopies on side-loading Stop Platforms shall have a single, non-spliced steel beam cantilevering at each column; column location shall be at the non-Track side edge of the Platform;
2. utilize rectangular hollow sections, coated black (colour code RAL 9011), for all columns and beams; and
3. conceal all required service runs within the structural members.

2-10.2.3.2 Neighbourhood Canopy

A. Neighbourhood Canopies shall:

1. have a metal roofing system designed to accommodate water shedding to integrated gutters and rain water leaders;
2. have a soffit made entirely out of wood with a natural wood colour that is consistent with the colour of other wood elements at the Stop;
3. have no visible connections between the wood soffit and the steel structure;
4. have a curved profile when viewed in section as shown in Figure 2-10.2.3 [*Stop and Station Canopies*]; and
5. provide up-lighting to softly and evenly illuminate the wood soffit at night.

2-10.2.3.3 Urban Canopy

A. Urban Canopies shall:

1. be nominally flat, as indicated in Figure 2-10.2.3 [*Stop and Station Canopies*], with a roof slope away from the Track edge of no more than 2%;
2. have a mullion-less structural silicone glazing roof connected to the steel beam structure by point-connected fittings;
3. accommodate water shedding to integrated gutters and rain water leaders; and
4. include tinting, etching, or fritting glazing treatments to achieve a nominal translucency of 50% light transmission.

2-10.2.4 Enclosed Shelters

- A. Each Stop Platform shall include enclosed Shelters meeting the requirements of Section 5-2.6.7 [*Shelters*] of this Schedule.
- B. Glass for vertical glazing panels may incorporate decorative applications associated with the Character Zone, Opportunity Area or Stop PI Theme provided such applications comply with CPTED requirements.

2-10.2.5 Seating

- A. Provide seating on each Stop Platform in accordance with Section 5-2.6.8 [*Seating*] of this Schedule and the Stop PI Theme.
- B. Steel elements of seating shall be coated back (colour code RAL 9011),

2-10.2.6 Leaning Rails

- A. Provide leaning rails on each Stop Platform in accordance with Section 5-2.6.9 [*Leaning Rails*] of this Schedule and the Stop PI Theme.
- B. Steel elements of leaning rails shall be coated black (colour code RAL 9011).

2-10.2.7 Waste and Recycling Receptacles

- A. Provide waste and recycling receptacles on each Stop Platform in accordance with Section 5-2.6.10 [*Waste and Recycling Receptacles*] of this Schedule and the Stop PI Theme.
- B. Steel elements of leaning rails shall be coated black (colour code RAL 9011).

2-10.2.8 Protection Railings

- A. Protection Railings shall meet the requirements of Section 2-4.5.3 [*Safety Barriers*] of this Schedule.
- B. Protection Railings and other obstructions are not permitted between a Platform and a sidewalk, SUP, park, or pedestrian plaza unless there is a grade change greater than 300 mm.

2-10.2.9 Platform Paving Material

- A. The finish of Platform paving materials shall comply with the requirements of Section 2-4.2 [*Streetscape*] of this Schedule.

2-10.2.10 Bicycle Racks

- A. Bicycle racks shall be free standing, galvanized, standard weight, surface-mount Hoop Bike Rack by Dero Bike Rack Co. with lean bar, or alternate acceptable to the City.
- B. Bicycle racks shall be spaced a minimum of 900mm apart or in accordance with the manufacturer's recommendations, whichever is greater, and each bicycle parking space shall have a minimum clear length of 1.8 m and a minimum vertical clearance of 2.0 m.
- C. Bicycle rack quantities shall be in accordance with Section 3-2.7 [*Bicycle Parking*] of this Schedule.
- D. Where required by Section 3-3.3.5 [*West Edmonton Mall Station Bicycle Parking*] and Section 3-4.3.2 [*Lewis Farms Stop Bicycle Facilities*] of this Schedule, provide bicycle shelters by Daytech Ltd., over bicycle racks to create Covered Bicycle Racks. Covered Bicycle Racks shall have an appearance similar to a Daytech Ltd. Vangarde transit and bus shelter.
- E. Access to and exit from bicycle parking spaces shall be provided with an aisle of not less than 1.5 m in clear width, including between rows of bicycle parking.
- F. Bicycle parking spaces and accesses shall be located on hard-surfaced areas.
- G. Bicycle parking shall be separated from vehicular parking by a minimum 1.5 m of open space.
- H. Bicycle racks shall be situated to maximize visibility and shall be placed within clear sight of the applicable Stop or Station or directional signage shall be displayed indicating their location.

2-10.2.11 On-Platform Poles

- A. All on-Platform poles shall use hollow steel cross-sections with the same surface finish as the Stop Canopies, and shall be coated black (colour code RAL 9011) with required services concealed within.

2-10.3 STOP AND STATION SPECIFIC REQUIREMENTS

2-10.3.1 Jasper Place Stop

- A. The Jasper Place Stop shall conform to the special requirements in Section 2-4.8 [*Jasper Place Opportunity Area Special Requirements*] of this Schedule.

2-10.3.2 Grovenor/142 St. Stop

- A. The Grovenor/142 St. Stop shall be integrated with the existing fabric of the West Block Glenora development to the north.
- B. The existing West Block Glenora development paving material, pattern and colouring shall be matched and integrated onto the new sidewalks.
- C. Coordinate with West Block Glenora developers so that the Platforms of the Grovenor/142 St. Stop are designed to visually integrate with the character of the West Block Glenora development consisting of similar paving materials, patterns, and colourings.

2-10.3.3 NorQuest Stop

- A. The NorQuest Stop shall conform to the special requirements in Section 2-4.7 [*Downtown Opportunity Area Special Requirements*] of this Schedule.
- B. Crosswalks and sidewalks at the NorQuest Stop will serve high volumes of transit users and pedestrians, which combined with the constrained width in this part of the LRT Corridor places a high priority on the free-flow of pedestrian movement and on the quality of the urban streetscape.
- C. The west Platform of the NorQuest Stop shall be integrated with the existing west sidewalk of 107 Street and all OCS and lighting poles, Passenger Interface Equipment, and structural supports for Canopies shall be coordinated with existing building elements of adjacent buildings.

2-10.3.4 Alex Decoteau Stop

- A. The Alex Decoteau Stop shall conform to the special requirements in Section 2-4.7 [*Downtown Opportunity Area Special Requirements*] of this Schedule.
- B. Crosswalks and sidewalks at the Alex Decoteau Stop will serve high volumes of transit users and pedestrians, which combined with the constrained width in this part of the LRT Corridor places a high priority on the free-flow of pedestrian movement and on the quality of the urban streetscape.
- C. The north Platform of the Alex Decoteau Stop shall be integrated with the existing north sidewalk of 102 Avenue and all OCS and lighting poles, Passenger Interface Equipment, and structural supports for Canopies shall be coordinated with existing park elements.
- D. Structures, furnishings, poles, and other Stop elements on the north Platform shall be positioned so as to compositionally relate to the streetscape features of Alex Decoteau Park, including pedestrian pathways.

2-10.3.5 WEM Station

- A. WEM Station shall be integrated with the WEM Transit Centre and shall comply with SUI Principles
- B. The design of the WEM Station shall optimize pedestrian flow within the WEM Station and shall take into consideration pedestrian flows for a future enclosed grade-separated pedestrian walkway tying into the L2 Mezzanine level and linking WEM Station to the WEM parkade on the north side of the Trackway as shown in Figure 2-10.3.5A [*Future Enclosed Grade-separated Pedestrian Walkway*].

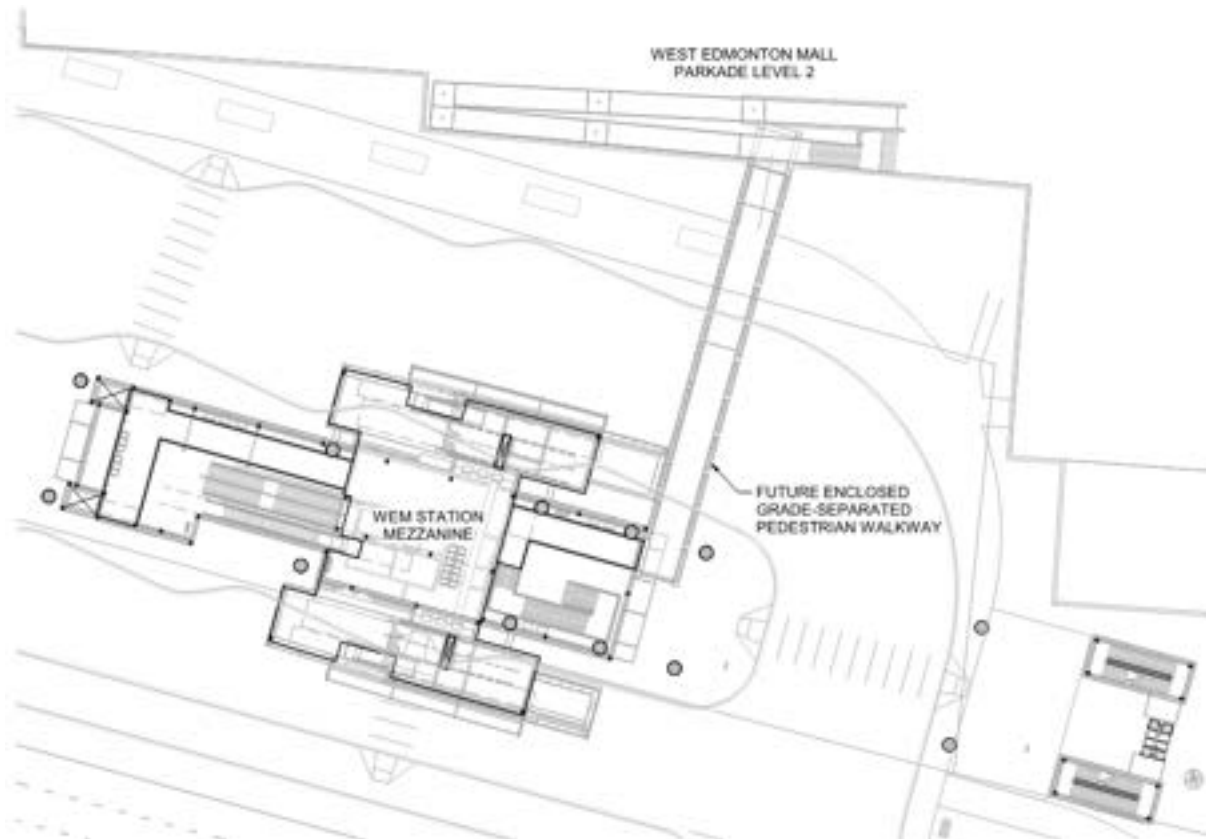

Figure 2-10.3.5A: Future Enclosed Grade-separated Pedestrian Walkway

- C. The design of the Platform level at the WEM Station shall be open with minimal sight-line obstructions along the Platforms.
- D. The design of the WEM Station shall incorporate architectural features that visually reinforce Passenger egress points and vertical circulation systems, from within the WEM Station and from the exterior.
- E. The primary architectural finishes of the WEM Station shall be concrete, glass, wood, steel and metal panel.
- F. Maximize the use of glass for the heated waiting areas at the L1 Ground level, L2 Mezzanine level and maximize the use of glass for the L3 Platform level for the Stations in accordance with CPTED principles as per Section 2-4.6 [*Crime Prevention Through Environmental Design (CPTED)*] of this Schedule.
 - 1. White spandrel glass shall be used where an interior wall is located parallel to the glass surface such that the interior of the glass is not accessible for custodial maintenance.
 - a. If the interior wall that precludes custodial maintenance is enclosing the area below a staircase or escalator, the spandrel glass shall nominally terminate along the diagonal line formed by the top of the stair stringer or the escalator truss, respectively.
- G. The non-trackside edges of the WEM Station Platforms shall be curved in plan such that their radii do not exceed the maximum (shown in millimetres) indicated in Figure 2-10.3.5B [*WEM Station Platform Curvature*].

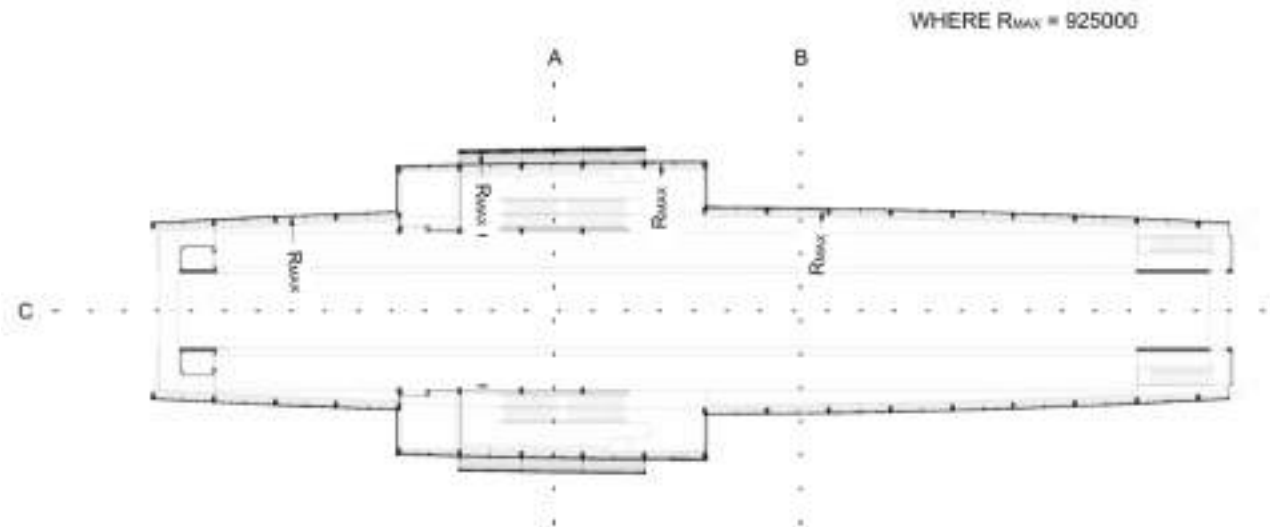

Figure 2-10.3.5B: WEM Station Platform Curvature

- H. The WEM Station Canopy shall be curved in both plan, cross section, and longitudinal section, such that it is nominally consistent with the proportions and its radii do not exceed the maximums (shown in millimetres) indicated in Figure 2-10.3.5B [*WEM Station Platform Curvature*], Figure 2-10.3.5C [*WEM Station Canopy: Cross Section*] and Figure 2-10.3.5D [*WEM Station Canopy: Longitudinal Section*], and shall comply with the following:
1. steel arch ribs, spaced at 6000 mm on centre, shall provide the primary structural support of the Canopy and façade;
 - a. the steel arch ribs shall be closed sections exposed to Public View; and
 - b. except for the exterior face of the cantilevered vertical circulation elements, there shall be no bracing exposed to Public View between the steel arch ribs;
 2. a symmetrical clerestory with transparent or open side walls, subject to Section 5-2.10.3B.2 [*General Station Requirements*] of this Schedule, shall be provided along the full length of the Platform for the WEM Station for natural light penetration, which shall;
 - a. be supported by closed steel sections that are in turn supported on the arch ribs; and
 - b. include a clerestory roof that cantilevers over the Platform Canopy roof by an amount nominally equal to the elevation difference between the clerestory roof and Canopy roof; and
 3. the walls of the Platform level and the walls of the cantilevered vertical circulation elements shall be glass, conforming to the following:
 - a. adequate glazing panels shall be used such that the curvatures of the glass walls appear to be nominally consistent with specified curvatures of the Canopy, without necessitating the use of curved glass;
 - b. vertical glazing supports along the Platforms shall be limited to one (1) support between each steel arch rib; and

- c. any glazing supports shall be smoothly curved such that they are nominally consistent with the radii indicated in Figure 2-10.3.5B [WEM Station Platform Curvature] through Figure 2-10.3.5D [WEM Station Canopy: Longitudinal Section] of this Schedule.

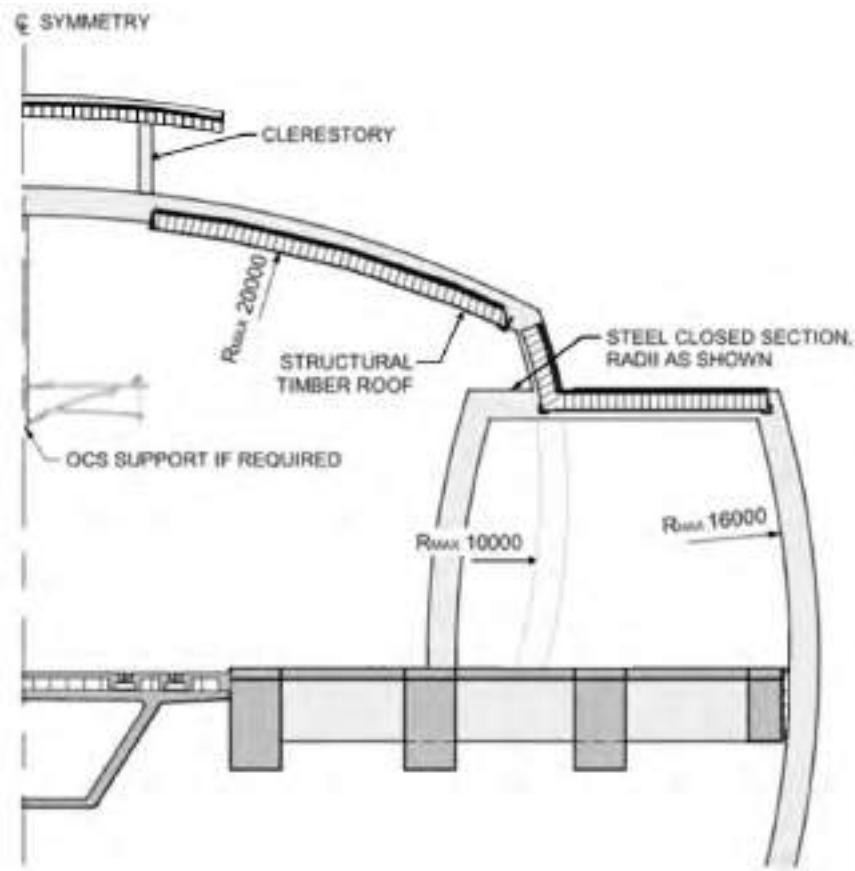

Figure 2-10.3.5C: WEM Station Canopy: Cross Section

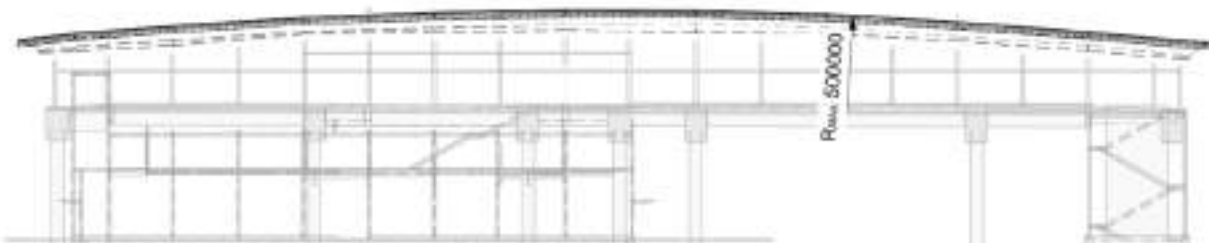

Figure 2-10.3.5D: WEM Station Canopy: Longitudinal Section

- I. The structural roof deck for the WEM Station, including the clerestory roof, shall consist entirely of structural timber construction and shall:
 1. span without additional supports between or over the arch ribs;
 2. span without additional supports between or over any clerestory supports; and

3. be exposed to form the entire soffit between each arch rib and any clerestory supports.
- J. The vertical circulation elements between the L2 Mezzanine level and L3 Platform level on the north and south side of the Station shall be provided with a solar shade screen secondary façade system, as nominally shown in Figure 2-10.3.5F [WEM Station Ceilings] and in Figure 2-10.3.5H [WEM Station Soffits – Axonometric View], such that:
1. the solar shade screens consists of perforated matte white metal panels supported by structural steel framing;
 2. the structural steel framing for the solar shade screens shall align with the supports for the glass cladding of the vertical circulation elements;
 3. the solar shade screen system shall be uniformly offset from the glass cladding of the vertical circulation elements by a minimum of 800 mm; and
 4. the solar shade screen system on each side shall extend the full height of wall of the vertical circulation elements and at least 18 m horizontally.
- K. The underside of the Canopy roof deck, including the clerestory roof deck, shall hang below the underside of the steel supports with concealed connections to create the appearance of a floating wood ceiling in accordance with Figure 2-10.3.5E [WEM Station Floating Timber Roof Deck]. The structural timber roof deck over the vertical circulation elements may be supported a minimum of 100 mm above the underside of the steel arch ribs with concealed connections in accordance with Figure 2-10.3.6C [Misericordia Station Timber Roof Deck].

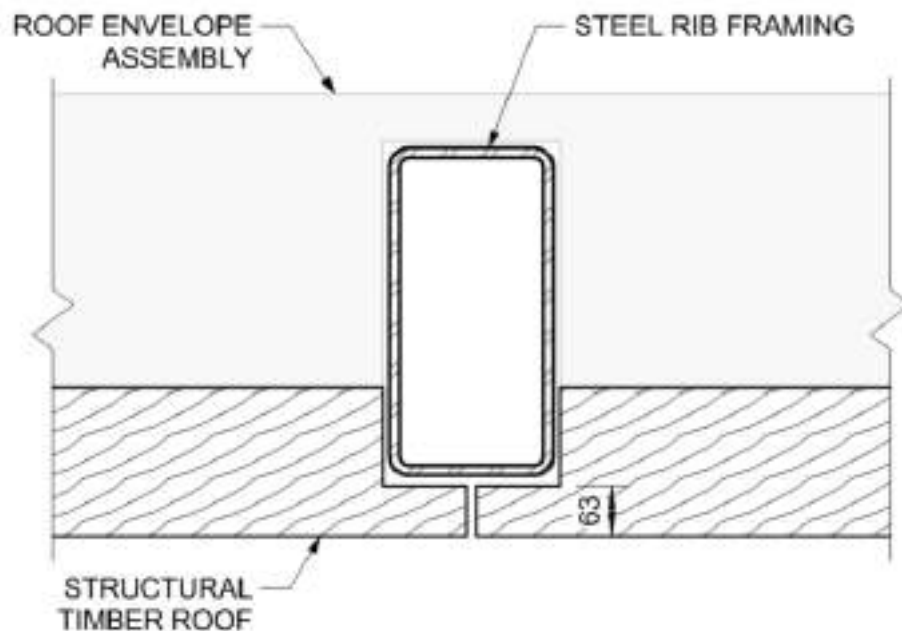

Figure 2-10.3.5E: WEM Station Floating Timber Roof Deck

- L. The OCS shall be supported off the steel arch ribs with no secondary framing, and OCS poles are not permitted within the Station.

- M. The interior ceiling over the heated waiting areas at the L1 Ground level and L2 Mezzanine level shall consist of acoustic metal panels and shall be nominally as shown in Figure 2-10.3.5F [WEM Station Ceilings], such that:
1. the ceiling shall form a “V” shape in section perpendicular to the Trackway;
 2. the lowest point of the ceiling shall be consistent for the entire ceiling and shall be a minimum of 3000 mm from top of architectural floor finish at the L2 Mezzanine level; and
 3. the size of the ceiling panels shall be a consistent increment of the spacing between the curtain wall mullions that enclose the heated waiting area on L1 Ground level, with joints aligning with the curtain wall mullions.

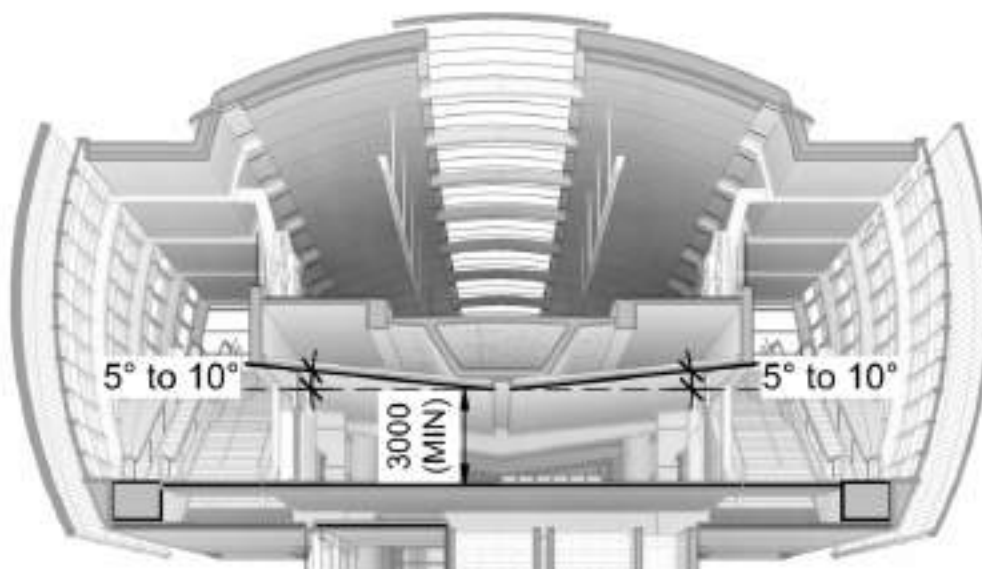

Figure 2-10.3.5F: WEM Station Ceilings

- N. The exterior soffits at the underside of the guideway/Platform shall be nominally as shown in Figure 2-10.3.5G [WEM Station Soffits – Section View] and Figure 2-10.3.5H [WEM Station Soffits – Axonometric View], such that:
1. the soffit shall consist of matte white metal panels except below the vertical circulation elements between the L2 Mezzanine level and L3 Platform level, where the soffit shall consist of exposed wood;
 2. the soffit panels shall form a “V” shape in section perpendicular to the Trackway with the angle and the lowest point being consistent with the ceiling panels shown in Figure 2-10.3.5F [WEM Station Ceilings]; and
 3. the size of the soffit panels shall be a consistent increment of the spacing between the curtain wall mullions that enclose the heated waiting area on L1 Ground level, with joints aligning with the curtain wall mullions.

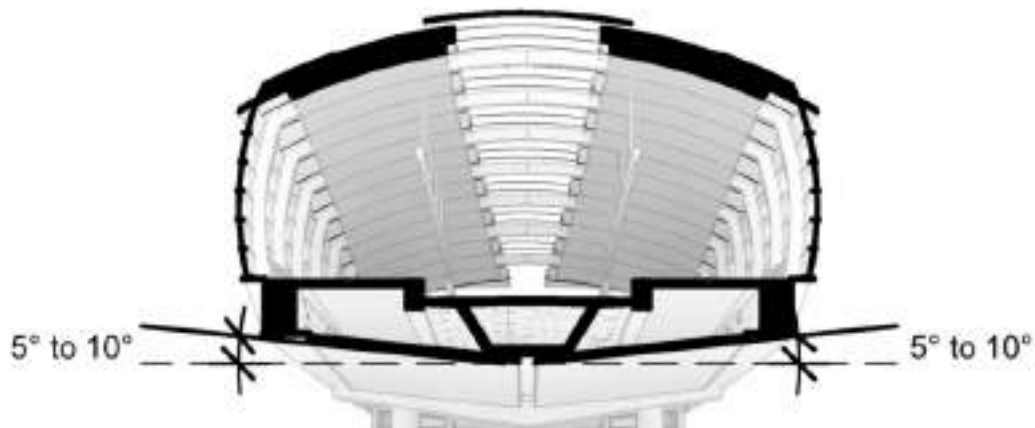

Figure 2-10.3.5G: WEM Station Soffits – Section View

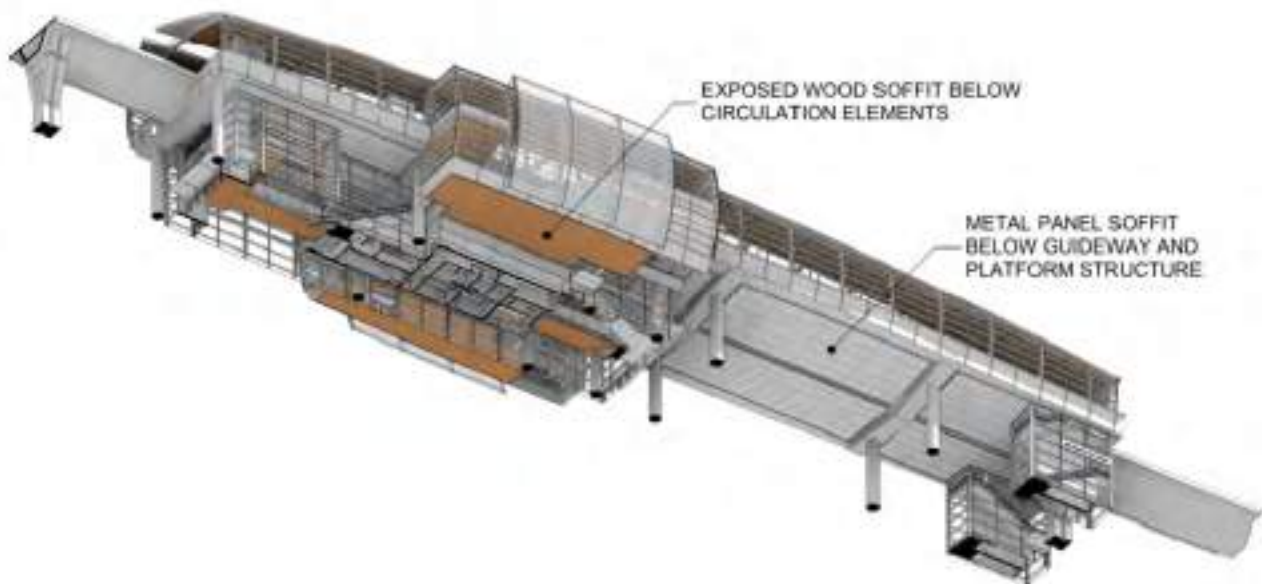

Figure 2-10.3.5H: WEM Station Soffits – Axonometric View

- O. All amenities, such as waste and recycling receptacles and benches shall be integrated with the overall design of the Stations and be consistent in quality to the amenities at the Stops.
- P. In addition to the requirements of Section 5-2.11.1 [*Program Requirements*] of this, emergency generators for the Station shall be:
 1. located exterior to the Station and WEM Transit Centre as shown in Figure 2-10.3.5I [*WEM Station Emergency Generator Location*] in a location that does not conflict with pedestrian traffic; and
 2. treated as Wayside Equipment Enclosures in accordance with Section 2-9.4 [*Wayside Equipment Enclosures*] of this Schedule.

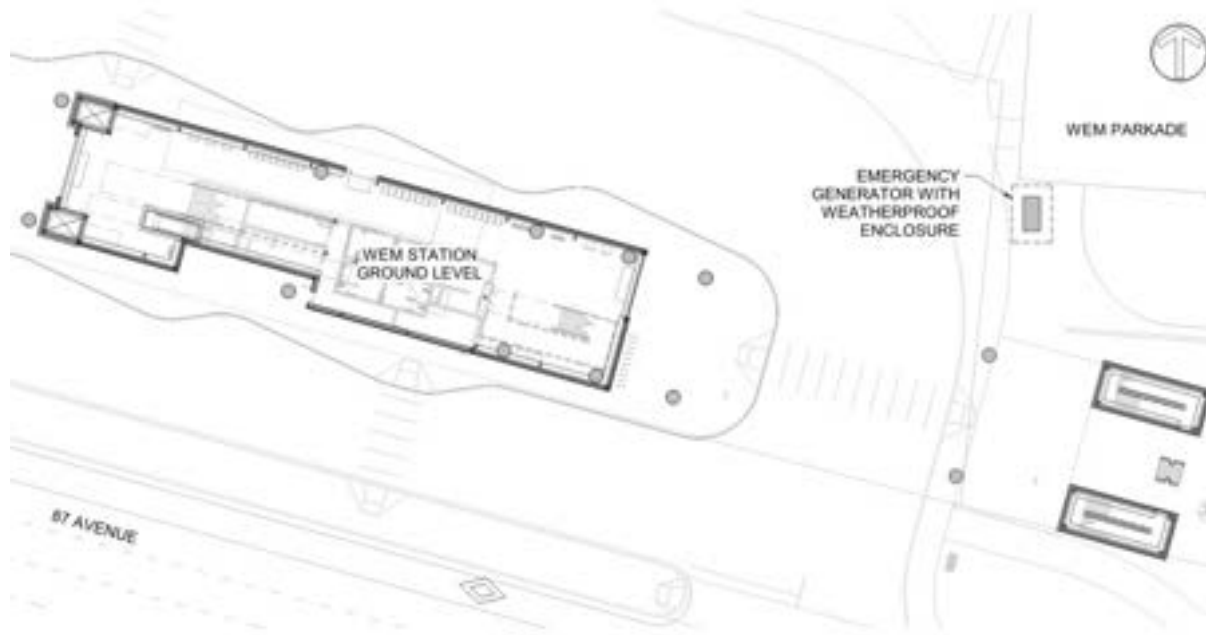

Figure 2-10.3.5I: WEM Station Emergency Generator Location

Q. Rooftop equipment shall not be permitted at the WEM Station.

2-10.3.6 Misericordia Station

- A. The design of the Misericordia Station shall optimize pedestrian flow within the Misericordia Station.
- B. The design of the Platform level at the Misericordia Station shall be open with minimal sight-line obstructions along the Platforms.
- C. The design of the Misericordia Station shall incorporate architectural features that visually reinforce Passenger egress points and vertical circulation systems, from within the Misericordia Station and from the exterior.
- D. The primary architectural finishes of the Misericordia Station shall be concrete, glass, wood, steel and metal panel.
- E. Maximize the use of glass for the heated waiting areas at the L1 Ground level, L2 Mezzanine level and maximize the use of glass for the L3 Platform level for the Stations in accordance with CPTED principles as per section 2-4.6 [*Crime Prevention Through Environmental Design (CPTED)*] of this Schedule.
 - 1. White spandrel glass shall be used where an interior wall is located parallel to the glass surface such that the interior of the glass is not accessible for custodial maintenance.
 - a. If the interior wall that precludes custodial maintenance is enclosing the area below a staircase or escalator, the spandrel glass shall nominally terminate along the diagonal line formed by the top of the stair stringer or the escalator truss, respectively.
- F. The Misericordia Station Canopy shall be curved in section such that it is nominally consistent with the proportions and its radii do not exceed the maximums (shown in millimetres) indicated in Figure 2-

10.3.6A [Misericordia Station Canopy – Section at Vertical Circulation] and Figure 2-10.3.6B [Misericordia Station Canopy – Section at Vertical Circulation], and shall comply with the following:

1. steel arch ribs, spaced at 6000 mm on centre, shall provide the primary structural support of the Canopy and facade;
 - a. the steel arch ribs shall be closed sections exposed to Public View; and
 - b. except for the exterior face of the cantilevered vertical circulation elements, there shall be no bracing exposed to Public View between the steel arch ribs; and
2. the walls of the Platform level and the walls of the cantilevered vertical circulation elements shall be glass, conforming to the following:
 - a. adequate glazing panels shall be used such that the curvature of the glass walls appears to be nominally consistent with specified curvature of the Canopy, without necessitating the use of curved glass;
 - b. vertical glazing supports along the Platforms shall be limited to one (1) support between each steel arch rib; and
 - c. any glazing supports shall be smoothly curved such that they are nominally consistent with the radii indicated in Figure 2-10.3.6A [Misericordia Station Canopy – Section at Vertical Circulation] and Figure 2-10.3.6B [Misericordia Station Canopy – Section Outside of Vertical Circulation] of this Schedule.

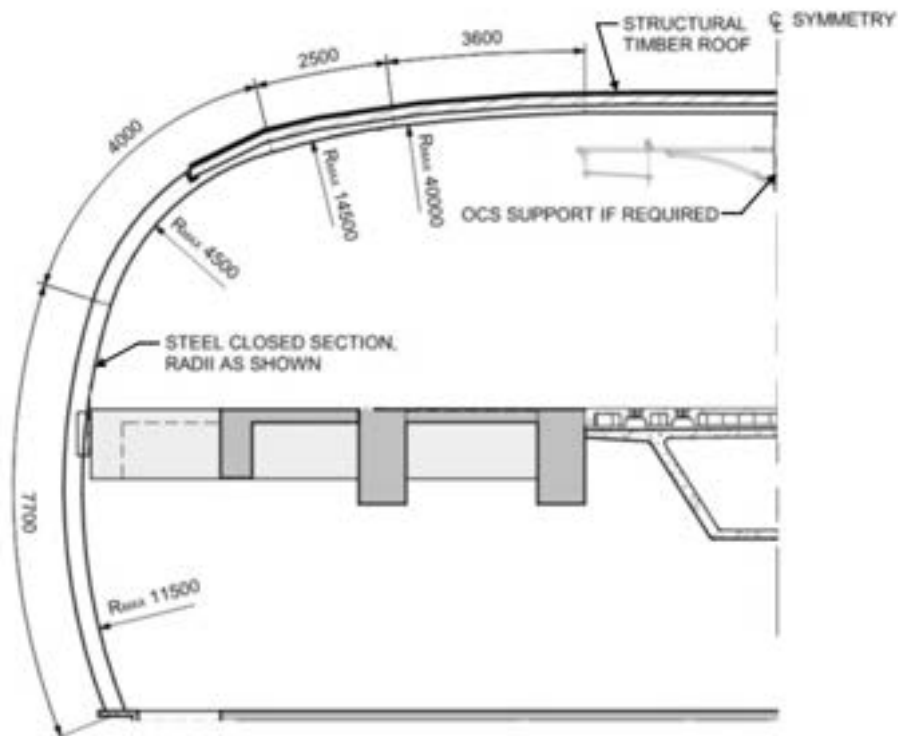

Figure 2-10.3.6A: Misericordia Station Canopy – Section at Vertical Circulation

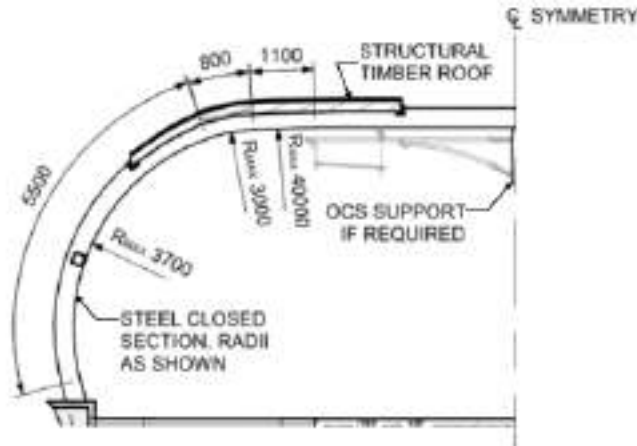

Figure 2-10.3.6B: Misericordia Station Canopy – Section Outside of Vertical Circulation

- G. The vertical circulation elements between the L2 Mezzanine level and L3 Platform level on the south side of the Misericordia Station shall be provided with matte white metal fins as nominally shown in Figure 2-10.3.6D [*Misericordia Station Ceilings*] and Figure 2.10.3.6E [*Misericordia Station Soffits – Axonometric View*], such that:
1. the metal fins shall be oriented horizontally along the main cladding of the vertical circulation element;
 2. the metal fins shall be uniformly spaced by maximum centre to centre dimension of 500 mm;
 3. the metal fins shall be minimum 300 mm wide; and
 4. the metal fins shall not preclude convenient access to the glass cladding for cleaning or maintenance purposes.
- H. The structural roof deck for the Misericordia Station shall consist entirely of structural timber construction and shall:
1. span without additional supports between or over the arch ribs;
 2. be exposed to form the entire soffit between each arch rib; and
 3. be constructed in accordance with Section 5-2.9.2 [*Structural Timber Construction*] of this Schedule.
- I. The underside of the Canopy roof deck shall be supported a minimum of 100 mm above the underside of the steel supports with concealed connections in accordance with Figure 2-10.3.6C [*Misericordia Station Timber Roof Deck*].

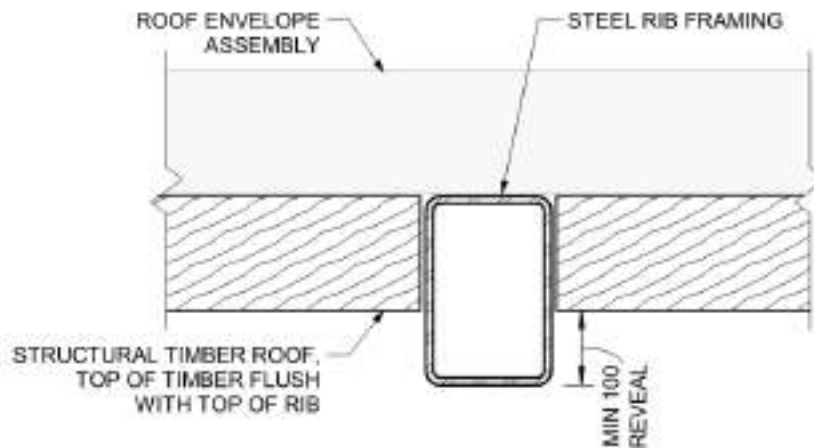

Figure 2-10.3.6C: Misericordia Station Timber Roof Deck

- J. The OCS shall be supported off the steel arch ribs with no secondary framing, and OCS poles are not permitted within the Station.
- K. The interior ceilings over the heated waiting areas at the L1 Ground level and L2 Mezzanine level shall consist of acoustic metal panels and shall be nominally as shown in Figure 2-10.3.6D [*Misericordia Station Ceilings*], such that:
 1. the ceiling of the heated waiting area at the L1 Ground level L2 Mezzanine level shall align with the exposed underside of the guideway structure;
 2. the minimum clear ceiling height at the L2 Mezzanine level shall be 3000 mm; and
 3. the size of ceiling panels shall be a consistent increment of the spacing between the curtain wall mullions that enclose the heated waiting area on L1 Ground level, with joints aligning with the curtain wall mullions.

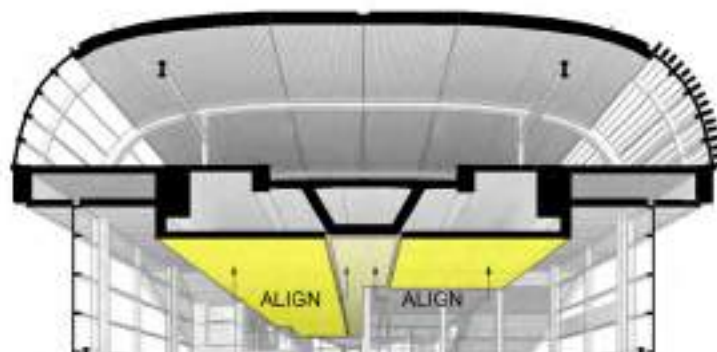

Figure 2-10.3.6D: Misericordia Station Ceilings

- L. The Platform structure of the Misericordia Station shall consist of a maximum of two (2) girders per Platform, which shall each be rectangular with an aspect ratio of one (1) wide to at least two (2) deep;
 1. the Platform structure shall be symmetrical with respect to the centerline of the Trackway.

- M. The Elevated Guideway superstructure cross-section within the length of the Misericordia Station shall extend a minimum of 300mm below the underside of the track-side Platform girders and shall:
1. be in accordance with Figure 2-11.2A [87 Avenue Elevated Guideway Section – Box Girder] of this Schedule and shall be of constant depth, which may be different than the depth of the superstructure for the rest of the 87 Avenue Elevated Guideway; or
 2. consist of two (2) identical rectangular girders below the Trackway that are arranged symmetrically with respect to the centerline of the Trackway and shall:
 - a. be equal in depth; and
 - b. have the same width as the trackside-edge Platform girders.
- N. The exterior soffits at the underside of the Elevated Guideway/Platform shall nominally be as shown in Figure 2-10.3.6E [Misericordia Station Soffits – Axonometric View], such that:
1. there is no applied soffit outside of the portion of the Station that houses the vertical circulation except if the Elevated Guideway superstructure cross section within the length of the Station is provided in accordance with Section 2-10.3.6M.2 [Misericordia Station] of this Schedule, in which case a dark grey metal panel soffit shall be provided between the two (2) Elevated Guideway girders, aligned with the underside of the girders and leaving the full underside of the girders exposed to Public View; and
 2. the soffit within the portion of the station that houses the vertical circulation shall consist of matte white metal panels, except directly below the cantilevered stairs and escalators, where the soffit shall consist of exposed wood:
 - a. the size of the soffit panels shall be a consistent increment of the spacing between the curtain wall mullions that enclose the heated waiting area on L1 Ground level, with joints aligning with the curtain wall mullions.

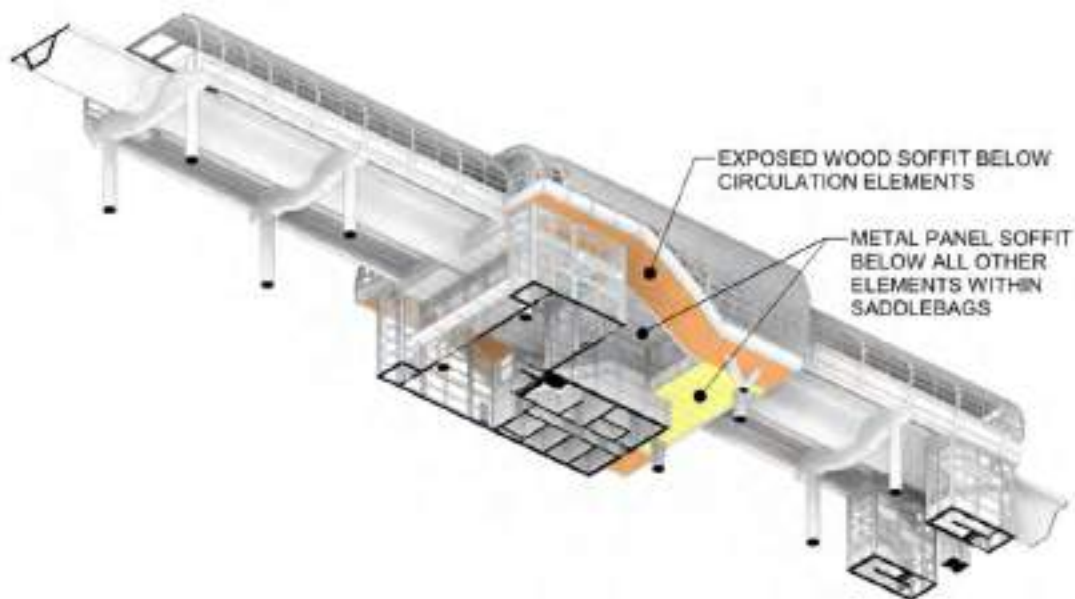

Figure 2-10.3.6E: Misericordia Station Soffits – Axonometric View

- O. All amenities, such as waste and recycling receptacles and benches shall be integrated with the overall design of the Stations and be consistent in quality to the amenities at the Stops.

- P. In addition to the requirements of Section 5-2.11.2.2 [*Program Requirements*] of this Schedule, emergency generators for the Station shall be:
1. located exterior to the Station in a location as shown in Figure 2-10.3.6F [*Misericordia Station Emergency Generator Location*] that does not conflict with pedestrian traffic; and
 2. treated as Wayside Equipment Enclosures in accordance with Section 2-9.4 [*Wayside Equipment Enclosures*] of this Schedule.



Figure 2-10.3.6F: Misericordia Station Emergency Generator Location

- Q. Rooftop equipment shall not be permitted at the Misericordia Station.

Section 2-11– STRUCTURES

2-11.1 GENERAL

- A. The overall configuration of each Building Structure and Transportation Structure shall reflect a simple elegance without the use of applied decoration.
- B. Details, textures, and colour shall incorporate and reflect the applicable Character Zone and Opportunity Area within which the Building Structure and Transportation Structure is located.
- C. Elements, such as Protection Railings, reveals and shadow lines shall be consistent and flow together to provide visual continuity, particularly at transitions between Structures and at terminations.
- D. Transitions in superstructure width shall either occur gradually with a slope of 1 short dimension perpendicular to the direction of travel to a minimum of 4 long dimensions parallel to the direction of travel in plan or be integrated into the design of the pier or, where permitted, the straddle bent.
- E. Transitions in superstructure depth shall:
 - 1. maintain the continuity of the line formed by the topmost element at the Structure's edge (either girder or barrier), and the bottommost element at the Structure's edge (girder soffit) and shall have a slope of 1 short dimension to a minimum of 4 long dimensions in elevation of the topmost and bottommost lines; or
 - 2. be integrated into the design of the pier or, where permitted, the straddle bent.
- F. Staining, including corrosion staining, of exposed to Public View concrete surfaces is not permitted.
- G. Provide curtain walls at Elevated Guideway abutment locations to cover the entire area from:
 - 1. the front of the abutment seat to;
 - a. the abutment backwall, for Structures without an Elevated Guideway Ramp; and
 - b. the low point of the ramp, for Structures with an Elevated Guideway Ramp;
 - 2. from bottom of the abutment seat to top of the abutment seat, when viewed perpendicular to the Elevated Guideway; and
 - 3. from the top of the abutment seat to the underside of deck when viewed parallel to the Elevated Guideway.
- H. If bearings are exposed to view when the Elevated Guideway is viewed in elevation, the top of adjacent bearing pedestals shall be at nominally equal height to each other.
- I. Subject to Section 2-11.1E.2 *[General]* of this Schedule, the line formed by the soffit of an Elevated Guideway, when viewed in elevation, shall be visually continuous, with no steps.
- J. Open box girder ends are not permitted.
- K. The height of the Elevated Guideway Ramps at both ends of the 87 Avenue Elevated Guideway shall be no more than 5 m measured from adjacent grade to top of rail.
- L. The exposed clear distance between grade and the soffit of an Elevated Guideway shall be a minimum of 1.5 m.
- M. Deck overhangs on Elevated Guideways that extend wider than the typical cross section is not permitted, except at switch locations, where the overhangs shall be tapered, transitioning along the

deck edge in accordance with Section 2-11.1.D [*General*] of this Schedule, without the use of struts to support the deck overhang.

- N. Straddle bents are not permitted, except within the length of the Platforms at the Stations. For the purpose of this Agreement, a straddle bent shall mean any Transportation Structure girder support consisting of two or more piers/columns capped by a beam, which in turn supports the superstructure girder.
- O. Emergency egress/maintenance pathways on Elevated Guideways shall be integrated into the deck cross-section. Pathways overhanging the outside of girders are not permitted.
- P. For Elevated Guideways, the elevation difference from the top of the lowest rail to the top of the Protection Railing, the collision barrier, or the superstructure for Structures with through primary load carrying members, shall not exceed 1260 mm.
- Q. Roadway work may necessitate modifications to the MacKinnon Ravine pedestrian bridge. Project Co shall be responsible for implementing such modifications. Modifications shall adhere to SUI Principles and maintain the look and feel of the existing bridge structure.
- R. Graffiti and stain resistant coatings shall be applied to all exposed to Public View surfaces of Transportation Structures to a minimum height of 3000 mm above finished grade; and
 - 1. the application of graffiti and stain resistant coatings shall not alter the colour of the surface to which it is applied such that it creates a visually apparent line between surfaces which have been treated and those which have been left untreated.

2-11.1.2 Finish of exposed structure surfaces

2-11.1.2.1 Concrete Finish

- A. For the purpose of this Section 2-11.1.2.1 [*Concrete Finish*], “*Architectural Concrete*” means all exposed to Public View concrete surfaces of Building Structures and Other Structures.
- B. Exposed to Public View concrete finishes for Transportation Structures shall comply with Section 4-4.5.21 [*Concrete Surface*] of this Schedule.
- C. Notwithstanding Sections 2-11.1.2.1A to 2-11.1.2.1B, top surfaces of sidewalks, Platforms, and Trackways shall comply with the requirements set out in Section 2-4.2 [*Streetscape*] of this Schedule.
- D. Architectural Concrete shall comply with ACI 303R Guide to Cast-in-Place Architectural Concrete Practice.
- E. Architectural Concrete shall as a minimum:
 - 1. have dense concrete finishes, free of deficiencies as set out in Section 4-4.4.20 [*Concrete Deficiencies*] of this Schedule, such as deep or extreme honeycombing, inconsistencies in plane, cold joint lines and loss of fines;
 - 2. be uniform in colour;
 - 3. exhibit sharp, accurate definition at corners, generally free of chipped or spalled areas;
 - 4. have plane surfaces without protuberances, indentations, ridges or bulges; and
 - 5. comply with the tolerances specified in ACI 347 *Guide for Formwork of Concrete*:
 - a. use Class A for surfaces within 3600 mm proximity of pedestrians;

- b. use Class B for surfaces between 3600 mm and 6000 mm of pedestrians; and
 - c. use Class C for finishes more than 6000 mm away from pedestrians, and for rough or textured formwork or surface treatments at any height.
- F. Finish tops of walls, horizontal offsets and similar unformed surfaces adjacent to formed Architectural Concrete surfaces trowelled smooth or with pattern and texture matching adjacent surfaces.
- G. Form ties for Architectural Concrete shall as a minimum:
- 1. be spaced regularly; and
 - 2. use tapered tie cone spreaders that, when removed, will leave holes not larger than 40mm in diameter on concrete surface.

2-11.1.2.2 Architectural Concrete Unit Masonry

- A. For the purpose of this Section 2-11.1.2.2 [*Architectural Concrete Unit Masonry*] “*Architectural Concrete Unit Masonry*” means all modular concrete masonry units that are exposed to Public View.
- B. Architectural Concrete Unit Masonry shall as a minimum:
- 1. use masonry units having uniform texture and colour, or having a uniform blend within a chosen colour range;
 - 2. use mortar of uniform quality and colour; and
 - 3. be free of staining.

2-11.1.2.3 Architecturally Exposed Structural Steel

- A. For the purpose of this Section 2-11.1.2.3 [*Architecturally Exposed Structural Steel*], “*Architecturally Exposed Structural Steel (AESS)*” means all steel surfaces for Transportation Structures and Other Structures which are exposed to Public View and located up to six (6) metres from any area designated for pedestrian access and all steel surfaces of Building Structures which are exposed to Public View.
- B. AESS shall comply with the requirements for “feature” or “showcase” elements in the *Canadian Institute of Steel Construction Code of Standard Practice for Structural Steel, Appendix I*;
- C. At all Stops and Stations, bolted connection joints for AESS shall generally occur at concealed locations. Where the design requires an unconcealed connection:
- 1. use architectural connections, such as acorn headed bolts and nuts, of consistent size and shape covering bolt threads completely; and
 - 2. align exposed nut and bolt heads, turned to the same position within the actual connection and aligned across groups of connections.
- D. Notwithstanding Section 2-11.1.2.3C [*Architecturally Exposed Structural Steel*], provide concealed connections for all timber and structural wood panel connections joining to steel.
- E. Stainless AESS shall comply with the *International Molybdenum Association and the Nickel Institute* requirements for specifying, selecting and fabricating austenitic stainless-steel sheet, bar or castings meeting ASTM material standards and:
- 1. shall be Type 316;

2. notwithstanding this Section 2-11.1.2.3E.1, may be Type 316L for welded connections; and
3. shall have finishes that are consistent with the requirements set out in Sections 2-11.1.2.3B to 2-11.1.2.3E of this Schedule.

2-11.2 87 AVENUE ELEVATED GUIDEWAY

2-11.2.1 Design Context

- A. This Section 2-11.2 [*87 Avenue Elevated Guideway*] sets out the SUI requirements for the 87 Avenue Elevated Guideway.
- B. The 87 Avenue Elevated Guideway passes through a mix of mature residential and commercial developments; from east to west, the Trackway becomes elevated in a single family residential neighbourhood, enters the Misericordia Station adjacent to the Misericordia Hospital in a medium density residential site that may experience future redevelopment and densification, extends over 170 Street through a single family residential neighbourhood bordered by WEM, enters the WEM Station, and then extends over 178 Street through further single family residential neighbourhood before returning to grade prior to 182 Street.

2-11.2.2 General Requirements

- A. The 87 Avenue Elevated Guideway shall be a slender, modern-appearing structure with clean lines and minimal visual complexity.
- B. The area under the 87 Avenue Elevated Guideway which are exposed to Public View shall use landscape and hardscape suitable for the site and environment including cast-in-place sidewalk, as required in accordance with Section 2-14.6.5 [*Under Guideway Landscape Area Special Requirements*] of this Schedule.
- C. The 87 Avenue Elevated Guideway Ramp at Aldergrove Park shall be located west of the crosswalk located on 87 Avenue between 180 Street and 181 Street, while maintaining a safe LRV stopping distance for the intersection of 87 Avenue and 182 Street.

2-11.2.3 Piers

- A. Piers shall be spaced no closer than 30 m, measured along the centerline of the 87 Avenue Elevated Guideway alignment.
- B. Except for the piers through the Stations, which shall be circular, the pier geometry of the 87 Avenue Elevated Guideway shall comply with Figure 2-11.2A [*87 Avenue Elevated Guideway Section – Box Girder*] and Figure 2-11.2B [*87 Avenue Elevated Guideway Section – Trough Girder*]:
 1. the top portion of the pier shall be nominally 4.7 m high with a sloped face and as follows:
 - a. for piers that are shorter than the constant triangular shape, the bottom of the triangular shape shall be cut off at grade;
 - b. the top portion shall include a triangular opening, with the opening faces parallel to the sides and top of the pier, respectively;
 - c. the dimension from the top of the opening to the top of pier shall not exceed 1 m;
 - d. the thickness of the two inclined pier shafts viewed in section shall not exceed 0.9 m; and
 - e. the width at the top of the pier viewed in section shall not exceed 4.5 m.

2. the lower portion of the pier shall be of variable length as required by the overall height of the pier and:
 - a. shall be tapered at 1 horizontal and between 12 and 15 vertical (dimension "T" in Figure 2-11.2A [87 Avenue Elevated Guideway Section – Box Girder] and Figure 2-11.9B [87 Avenue Elevated Guideway Section – Trough Girder]), with the width of the transition between the top and lower portions viewed in section (dimension "W" in Figure 2-11.2A and Figure 2-11.9B) not exceeding 2.0 m; or
 - b. shall be tapered at 1 horizontal and 15 vertical (dimension "T" in Figure 2-11.2A [87 Avenue Elevated Guideway Section – Box Girder] and Figure 2-11.9B [87 Avenue Elevated Guideway Section – Trough Girder]), with the width of the transition between the top and lower portions viewed in section (dimension "W" in Figure 2-11.2A and Figure 2-11.9B) not exceeding 2.2 m.
3. Provide full height recesses on the elevation face of piers to conceal down-pipes for drainage, standpipes, and any other Utilities.

2-11.2.4 Superstructure

- A. The cross-section of the superstructure shall meet the requirements of Figure 2-11.2A [87 Avenue Elevated Guideway Section – Box Girder] or of Figure 2-11.2B [87 Avenue Elevated Guideway Section – Trough Girder].

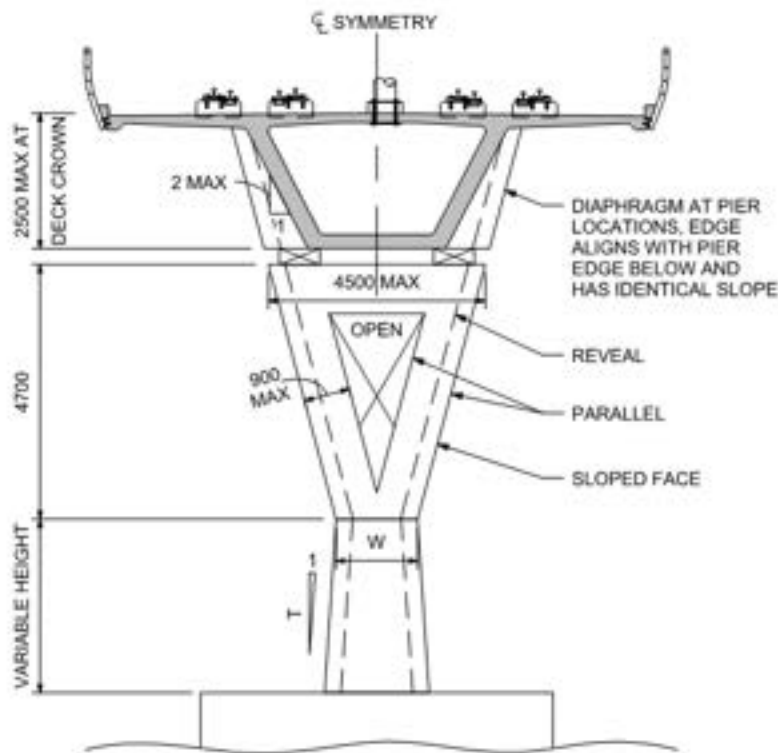

Figure 2-11.2A: 87 Avenue Elevated Guideway Section – Box Girder (dimensions in mm)

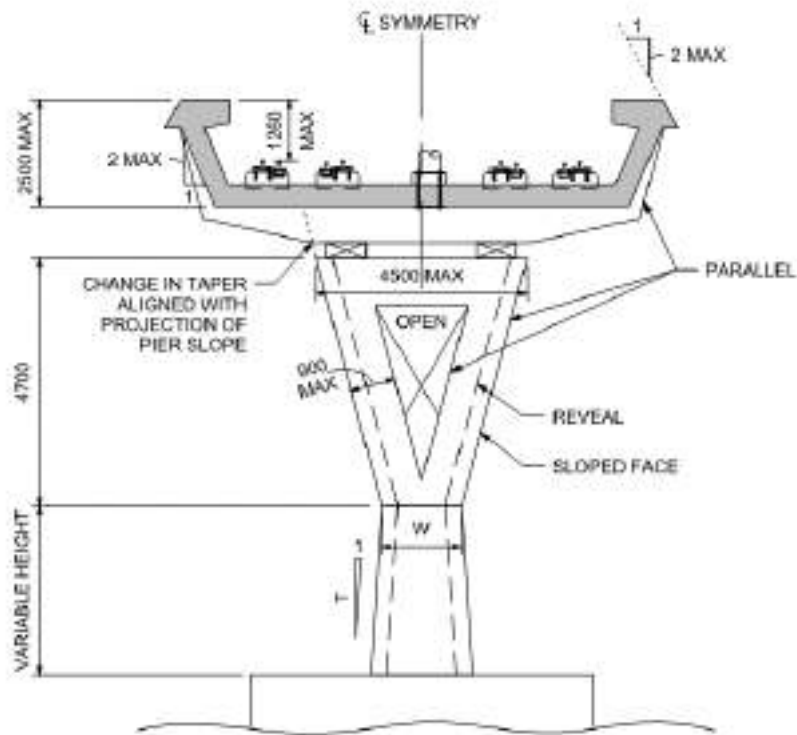

Figure 2-11.2B: 87 Avenue Elevated Guideway Section – Trough Girder (dimensions in mm)

- B. The girder cross-section shall use the same type and be of constant depth from the east abutment to the west abutment, except for the Platform lengths of the Misericordia Station and the WEM Station, and shall be no more than 2.5 m from girder soffit to the top of the superstructure.
- C. Notwithstanding Section 2-11.2.B [87 Avenue Elevated Guideway], a variable depth girder with a curved soffit is permitted for spans where a 2.5 m maximum depth girder cannot be achieved, provided that:
 1. the depth from girder soffit to the top of the superstructure at the two piers immediately east and west of the applicable span shall be no more than 3.5 m as shown in Figure 2-11.3C [87 Avenue Elevated Guideway Elevation – Variable Depth Girder];
 2. the depth from girder soffit to the top of the superstructure at mid-span of the applicable span and at the piers at the far end of the spans immediately adjacent to the applicable spans shall be no more than 2.5 m as shown in Figure 2-11.3C [87 Avenue Elevated Guideway Elevation – Variable Depth Girder];

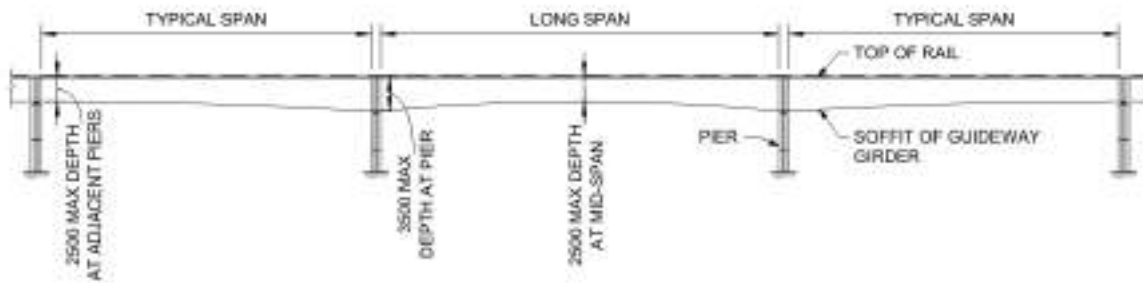

Figure 2-11.2C: 87 Avenue Elevated Guideway Elevation – Variable-Depth Girder (dimensions in mm)

3. the cross-section shall appear as a single concrete box girder if a box girder is used on the other portions of the 87 Avenue Elevated Guideway or appear as a single concrete trough girder if a trough girder is used on the other portions of the 87 Avenue Elevated Guideway, with webs for both types of girders having an inclination of 1 horizontal to maximum 4 vertical; and
 4. The curved transition of the variable depth girder soffit from the 3.5 m maximum depth at piers to the 2.5 m maximum girder depth at mid-spans shall occur over a minimum length of 9 m parallel to the 87 Avenue Elevated Guideway.
- D. The visual depth, seen in elevation, from the top to the bottom of the top flanges shall be constant over the length of the 87 Avenue Elevated Guideway, including the 87 Avenue Elevated Guideway Ramps.
- E. The lines of the top and bottom of the top flanges, as seen in elevation, shall be visually continuous at the junction of the superstructure with the abutment and down the entire length of the 87 Avenue Elevated Guideway Ramp.
- F. The superstructure of the 87 Avenue Elevated Guideway shall appear as:
1. a single concrete box girder and shall have:
 - a. access hatches from the deck level;
 - b. the top of the superstructure taken as the deck crown;
 - c. webs having an inclination of 1 horizontal to maximum 2 vertical;
 - d. girder diaphragms at pier locations, aligning with the pier edges when viewed both in section and in elevation and having the same slope as the top portions of the piers;
 - e. a tapered soffit at maximum 20 horizontal to 1 vertical at the overhangs; and
 - f. slab thickening at the overhang edges; or
 2. a single concrete trough girder and shall have:
 - a. the top of the superstructure taken as the highest point of the top flanges;
 - b. webs having an inclination of 1 horizontal to maximum 2 vertical;
 - c. girder diaphragms at pier locations:

- i. aligning with the pier edges when viewed in elevation;
 - ii. having the same slope as the top portions of the piers; and
 - iii. having a change in taper that lines up with the projection of the pier edges when viewed in section; and
- d. top flanges that have:
- i. a slope of the outside edge of 1 horizontal to maximum 2 vertical; and
 - ii. an overhang creating a distinct shadow line.

2-11.2.5 87 Avenue Elevated Guideway Ramps

- A. The outside face of the 87 Avenue Elevated Guideway Ramp walls shall:
- 1. have a maximum of one (1) horizontal to fifty (50) vertical batter; and
 - 2. be a minimum of 500 mm inset from the outside edge of deck curb, with the deck curb matching the deck curb or top flange of the rest of the 87 Avenue Elevated Guideway, as shown in Figure 2-11.2D [*87 Avenue Elevated Guideway Ramp Partial Section - Box Girder*] and Figure 2-11.2E [*87 Avenue Elevated Guideway Ramp Partial Section - Trough Girder*].
- B. The 87 Avenue Elevated Guideway Ramp walls along 87 Avenue shall be precast concrete panels of consistent 3 m width with no horizontal joints (i.e., panel size shall be full Elevated Guideway Ramp height).
- C. The abutments (transition from bridge Structure to the 87 Avenue Elevated Guideway Ramps) shall have a vertical face perpendicular to the Track and match the width of the bridge Structure.

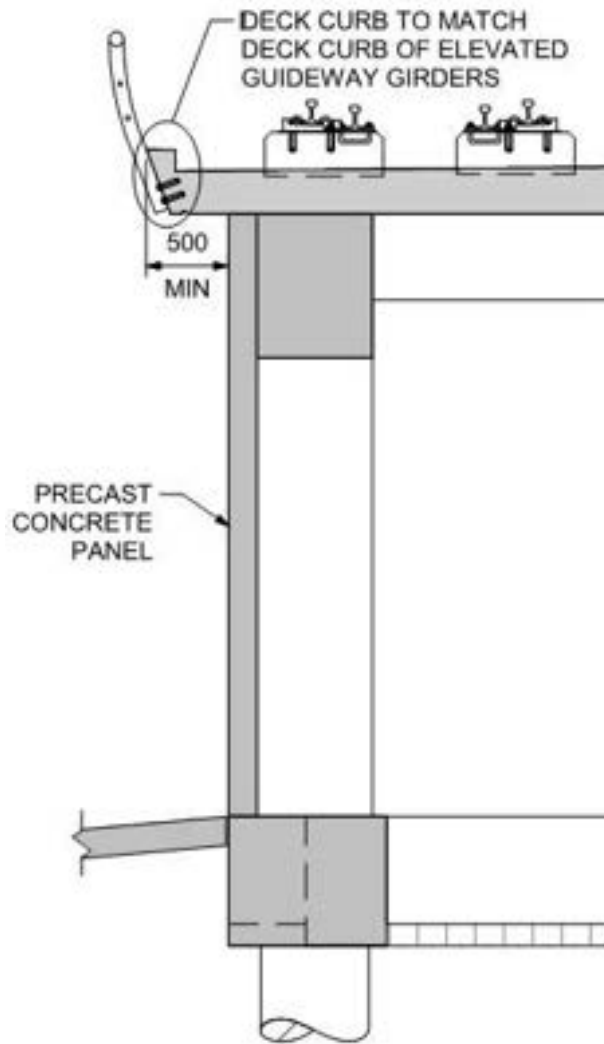

Figure 2-11.2D: 87 Avenue Elevated Guideway Ramp Partial Section - Box Girder

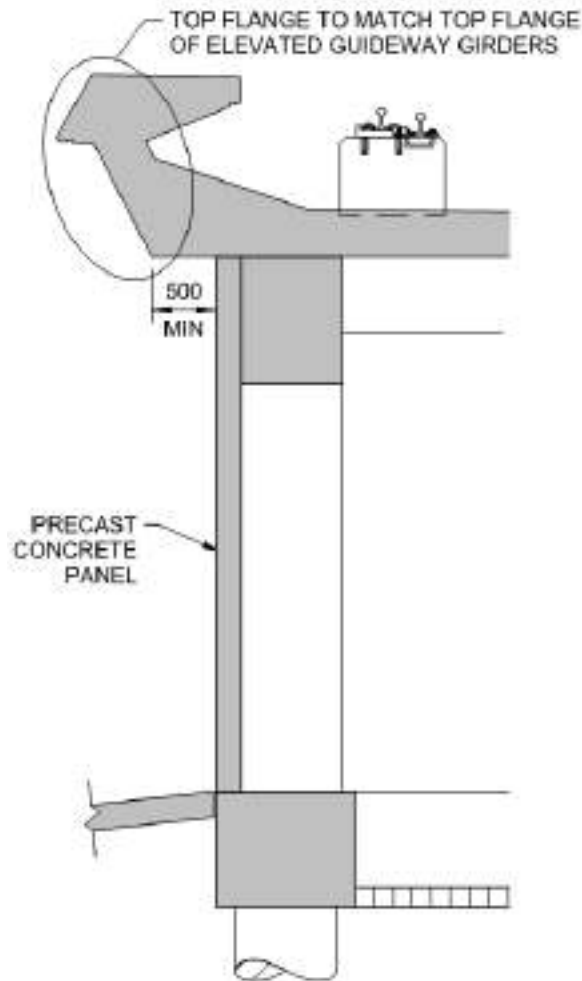

Figure 2-11.2E: 87 Avenue Elevated Guideway Ramp Partial Section - Trough Girder

2-11.3 ANTHONY HENDAY DRIVE LRT BRIDGE

- A. This Section 2-11.3 [*Anthony Henday Drive LRT Bridge*] sets out the SUI requirements for the Anthony Henday Drive LRT Bridge.
- B. The Anthony Henday Drive LRT Bridge abutments, piers and girder shall be concrete.
- C. The aesthetic features of the Anthony Henday Drive LRT Bridge shall be nominally consistent with the Anthony Henday Drive Traffic Bridge, including:
 - 1. the form, colour, and texture of the pier and pier cap;
 - 2. the colour and texture of the superstructure and abutments; and
 - 3. the skew of the superstructure, piers, and abutments.
- D. A curtain wall shall be used to conceal the interfaces between the superstructure and the abutments of the Anthony Henday Drive LRT Bridge, and shall be nominally consistent with the color, texture,

and form of the curtain walls of the Existing Anthony Henday Drive Bridge and shall include a matching wild rose relief on the southeast and northwest curtain wall.

- E. New retaining wall structures shall be consistent with the form, design, and colour of the existing retaining walls adjacent to the Existing Anthony Henday Drive Bridge.
 - 1. Where new retaining walls adjoin to existing retaining walls, they shall be visually and physically integrated with the existing retaining walls with construction joints located at existing control joints.
- F. The visual transition from the bridge barrier, to the approach span railing, to no railing, shall be such that they flow together to provide visual continuity with no abrupt vertical faces.
- G. Notwithstanding Section 2-11.1P *[General]* of this Schedule the elevation difference from the top of the lowest rail to the top of the Protection Railing, the collision barrier, or the superstructure for Structures with through primary load carrying members may exceed 1260 mm for the Anthony Henday Drive LRT Bridge.

2-11.4 STONY PLAIN ROAD BRIDGE

- A. This Section 2-11.4 *[Stony Plain Road Bridge]* sets out the SUI requirements for the Stony Plain Road Bridge.
- B. The aesthetic features of the superstructure, abutments, protection rails and barriers of the Stony Plain Road Bridge shall be nominally consistent with the existing 102 Avenue Bridge over Groat Road.
- C. The Stony Plain Road Bridge shall consist of a concrete deck on haunched steel girders that span over Groat Ravine with no piers.
- D. The haunched girders shall:
 - 1. taper to two thirds of their maximum height along the centreline of Groat Road through smoothly varying the elevation of the bottom flanges based on a vertical parabolic curve with no steps;
 - 2. have a horizontal profile that is either straight between the two abutments or curved with a constant radius; and
 - 3. be separated by equal spacing which may vary along the length of the girders.
- E. The exterior girders shall be positioned so that the width of the north and south deck overhangs on the east and west side of the longitudinal bridge centreline are equal, as indicated by dimensions “A” and “D” in Figure 2-11.4 *[Stony Plain Road Bridge Symmetric Overhang from Exterior Girders]*.

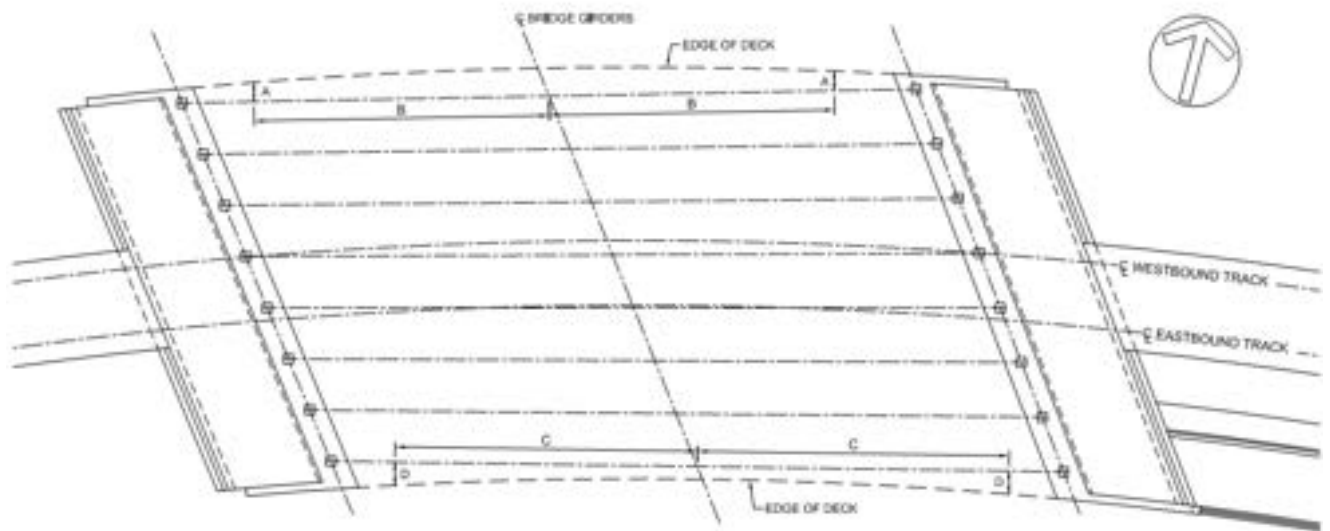

Figure 2-11.4: Stony Plain Road Bridge Symmetric Overhang from Exterior Girders

- F. Vertical stiffeners, except for bearing stiffeners, are not permitted on the exterior face of the outer girders.
- G. A Wildlife Crossing Bench shall be provided on each abutment slope, to allow for wildlife crossing in accordance with Section 22.3 [*Permanent Accommodation of Wildlife Movement*] of Schedule 10 [*Environmental Performance Requirements*] and Section 2-14.9.3.5C [*Park Parcel Specific Requirements*] and Section 4-3.2.14 [*Wildlife Crossing*] of this Schedule.
- H. Any walls adjoining with the abutments of the Stony Plain Road Bridge shall be visually integrated with the abutments and shall match the colour, finish, and texture of the abutments.

2-11.5 WALLS

2-11.5.1 General

- A. This Section 2-11.5 [*Walls*] sets out the SU requirements for all walls forming part of the Infrastructure, including retaining walls, abutment walls, Elevated Guideway Ramp walls, Noise Attenuation Walls and landscaping walls.
- B. Wall form, material, colour and texture shall integrate into and be reflective of the applicable site context.
- C. Overall wall configuration shall reflect simple elegance.
- D. The length and height of walls shall be minimized by use of slopes and landscaped terraces.
- E. Protection Railings on walls shall have post spacing coordinated with the aesthetic of the wall.
- F. Corrugated steel walls are not permitted.
- G. The base of all walls shall be buried a minimum of 300 mm below adjacent finished grade.
- H. If pilasters form a component of a wall:

1. spacing of pilasters shall be uniform; and
2. a transition from the wall face to the pilaster face shall be provided.

2-11.5.2 Alignment and Geometry

- A. Retaining walls shall not be located to create a barrier to pedestrian or cyclist connections between upper and lower grades.
- B. Walls shall follow horizontal and vertical curves to match the upper grade without abrupt angular changes.
- C. Notwithstanding Section 2-11.5.2B [*Alignment and Geometry*], the top of modular walls, may be stepped; the horizontal measurement between steps shall be in constant proportion to the vertical change and shall not be steeper than 1 vertical to 6 horizontal; the absolute height change at a discrete step in wall height shall not exceed 300 mm.
- D. Top of barriers and fences on walls shall be parallel to the top of wall; for stepped walls, the top of barriers and fences shall not have a step, and the top of the barrier or fence at each step location shall be a constant height above the top of wall as shown in Figure 2-11.5.2A [*Stepped Walls*].
- E. Retaining walls shall not protrude more than 200 mm above the adjoining grade.
- F. Align walls in continuous horizontal curves related to adjacent Roadways, Trackways, and landforms.

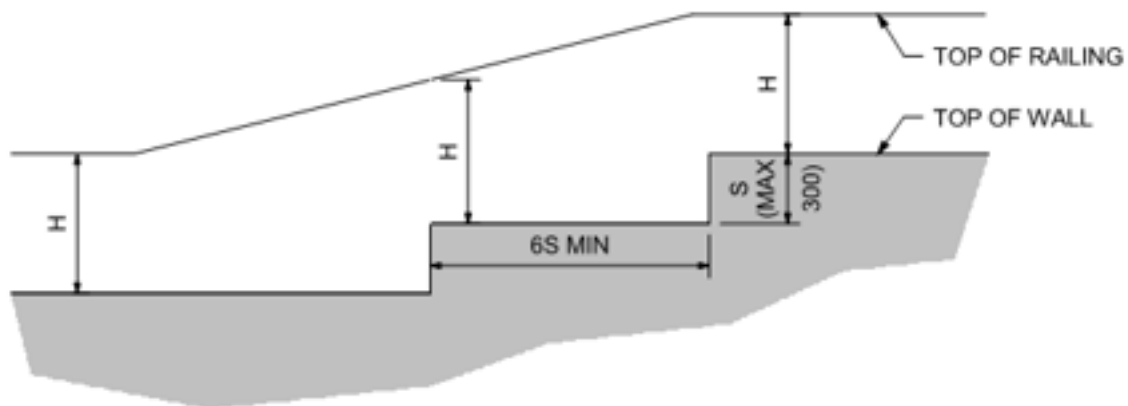

Figure 2-11.5.2A: Stepped Walls

2-11.5.3 Texture

- A. Wall finish shall be:
 1. concrete;
 2. wood;
 3. stone; or
 4. masonry.
- B. Primary support members may be steel.
- C. Wall finishes and support members shall have no lustre.

- D. Design scale and content of wall textures in response to the proximity and speed of the observer.
- E. Continuous walls shall have a consistent aesthetic theme and character.
- F. Patterning of walls shall emphasize horizontal flow and reduce the perceived height of the wall.
- G. Walls higher than 1.2 m and longer than 20 m shall be designed to create visual interest and to reduce the visual mass of the wall by using one of the following strategies:
 - 1. continuous horizontal elements that undulate along the wall face to create a flowing pattern; or
 - 2. a pattern of regularly repeating elements that create a rhythmic progression along the wall.
- H. Freestanding walls shall be textured on both sides, with each side responding to its adjacent context.
- I. Locate construction joints in exposed concrete surfaces to minimize visual intrusion.
- J. Conceal construction joints in exposed concrete surfaces by use of reveals or other architectural details.
- K. Any new retaining wall adjacent to the road along the west side of 170 Street, south of 87 Avenue, shall be consistent with the material, colour and texture of the existing retaining wall that it ties into.
- L. Any new retaining wall required on the north side of 104 Avenue between 116 Street and 118 Street shall be constructed with Allan Block and appear substantially similar to the existing retaining wall in the same location.

Section 2-12 – WEM TRANSIT CENTRE

2-12.1 GENERAL

- A. The WEM Transit Centre is a prominent transit hub adjacent to 87 Avenue and West Edmonton Mall. The WEM Transit Centre shall reflect the character and identity of the West Edmonton Character Zone and the West Edmonton Mall Opportunity Area with a modern, forward-thinking design that makes a positive contribution to the Valley Line and the ETS brand and its design shall comply with SUI Principles.
- B. This Section 2-12 [*WEM Transit Center*] sets out SUI requirements in addition to other Project Requirements for the WEM Transit Centre.

2-12.2 TRANSIT SHELTERS AND SEATING

- A. Shelters and all amenities, such as waste and recycling receptacles, benches, and bicycle racks, shall be integrated with the overall site context and be consistent in quality to the shelters and amenities at the Stops.
- B. Provide transit shelters in accordance with Section 3-3.3.2 [*Passenger Loading Platforms*] of this Schedule that each accommodate:
 - 1. seating for a minimum of four (4) persons, with each seat having arm rests; and
 - 2. space for two (2) Reference Wheelchairs.
- C. The side walls of the concrete planting beds specified in Section 2-14.6.5.3D [*Area Specific Requirements*] of this Schedule shall serve as seating and shall include wood sitting surfaces and arm rests between each seat.
- D. In addition to the seating in the transit shelters and surrounding the concrete planting beds, provide three (3) seating areas on the WEM North Passenger Loading Area, four (4) seating areas of the WEM South Passenger Loading Area, and four (4) seating areas on the WEM Central Passenger Loading Area for a total of eleven (11), such that:
 - 1. each seating area shall accommodate a minimum of three (3) persons, for a total of thirty-three (33) persons for all areas;
 - 2. seating shall be in accordance with the WEM Station PI Theme;
 - 3. each seating area shall allow for a mix of bench types (armrests/armless, backrests/ backless) and heights in accordance with the City of Edmonton Access Design Guide;
 - 4. no less than 50% of seating shall be designed for seniors in accordance with the City of Edmonton Access Design Guide; and
 - 5. seating shall be conveniently located for bus users outside of bus boarding/alighting areas and orientated to face bus traffic with clear sightlines to all adjacent bus stops served by the seating.
- E. Provide a minimum of two (2) waste receptacles on the WEM North Passenger Loading Area, two (2) waste receptacles on the WEM Central Passenger Loading Area outside of the WEM Station, and two (2) waste receptacles on the WEM South Passenger Loading Area.

2-12.3 CLOCK TOWER

- A. Provide a Clock Tower complying with Section 5-2.6.13 [*Clock Tower*] of this Schedule placed adjacent to the Roadway northeast of the east bus access to the WEM Transit Centre off 87 Avenue

such that it is easily viewable from both sides of 87 Avenue, with the following alterations and details to the Clock Tower:

1. do not include the line name panel;
2. write "West Edmonton Mall Transit Centre" in the stop name panel;
3. orient the Clock Tower such that its long dimension is perpendicular to 87 Avenue;
4. orient the high side of the Clock Tower to the south; and
5. have the same surface finish for the structural elements and use the same type of steel cross section as the Clock Tower at Misericordia Station as specified in Section 5-2.6.13.F [*Clock Tower*] of this Schedule.

Section 2-13 – MAINTENANCE AND STORAGE FACILITIES

2-13.1 GERRY WRIGHT OMF

- A. The Gerry Wright OMF Site is a prominent location adjacent to a city-wide freeway, Whitemud Drive, and two (2) arterial roads, 75 Street and 51 Avenue.
- B. The Gerry Wright OMF Building B shall integrate with the common identity of the existing Gerry Wright OMF Building A campus with a modern, forward-thinking design that makes a positive contribution to the Valley Line and the ETS brand, particularly when viewed from Whitemud Drive and 51 Avenue, and shall satisfy the requirements of Section 8-2.6 [*Gerry Wright OMF Building B*] of this Schedule.
- C. The Gerry Wright OMF Building B shall:
 1. utilize metal panel wall cladding with background and accent colours that match those of the Gerry Wright OMF Building A, including:
 - a. background colour: medium grey, Pantone 428C;
 - b. accent colour: dark grey, Pantone Cool Grey 6C;
 - c. accent colour: light blue, Pantone 653C; and
 - d. accent colour: dark blue, Pantone 294C;
 2. utilize LRV, loading and service doors that are coloured to match the LRV, loading and service doors of the Gerry Wright OMF Building A (green, Pantone 355C);
 3. utilize architectural screening to fully conceal any required rooftop equipment from view;
 4. incorporate glazed clerestories that are continuous over the length of maintenance, cleaning and storage areas and are oriented to introduce daylighting while mitigating glare from direct sunlight:
 - a. clerestory glazing shall be vertical and minimum 2.0 m high over maintenance and cleaning areas and minimum 1.2 m high over storage areas;
 - b. clerestory glazing may be shaded to mitigate glare;
 - c. light shelves shall be used to assist with daylighting;
 - d. where there are flat roof areas adjacent to clerestories, roofing materials shall have a minimum initial reflectance of 0.65 and a minimum 3-year aged reflectance of 0.5;
 - e. interior roof structure, decking and ceiling mounted ductwork shall be painted white, with a minimum initial reflectance of 0.8;
 - f. ducts and other systems shall be placed to minimize interference with daylight from clerestories;
 - g. electric lighting controls shall be integrated to incorporate daylight harvesting;
 - h. clerestories shall be designed such that glazing is accessible for ongoing maintenance and cleaning (interior and exterior); and
 - i. clerestories shall not be provided over LRV entrance areas where the OCS prevents safe glazing maintenance and cleaning, based on the Safety and Security Certification Program;

5. utilize roofing that matches the background colour of the exterior walls (medium grey, Pantone 428C), with matching prefinished metal edging, trims, and flashings, where required; and
 6. incorporate sloped roof surfaces to complement the form of the Gerry Wright OMF Building A.
- D. The design of the Gerry Wright OMF Building B shall:
1. use landscape, berming and building massing to screen open material storage and soften the industrial function of the site; and
 2. locate perimeter barriers, fences and walls, and building edges that front onto Whitemud Drive and 51 Avenue such that they integrate with the existing site design.
- E. The form, colours, and materials of the AVIS facility and any other standalone structures, such as exterior storage facilities, on Gerry Wright OMF Parcel B shall integrate with the form, colours and materials of the Gerry Wright OMF Building B.
- F. Rooftop mechanical equipment shall be minimized by maximizing the amount of mechanical equipment concealed within a central, louvered mechanical penthouse.

2-13.2 LEWIS FARMS STORAGE FACILITY

- A. The proposed Lewis Farms Storage Facility is in a prominent location within the Lewis Farms Park and Ride, adjacent to a residential community, an open space recreational area, and a major provincial highway (Anthony Henday Drive).
- B. The design of the Lewis Farms Storage Facility shall:
1. integrate with the West Edmonton Character Zone and make a positive contribution to the Valley Line and the ETS brand;
 2. consist of a single building that satisfies the requirements of Section 8-3.6 [*Lewis Farms Storage Facility Building*] of this Schedule, with a repeating sawtooth roof profile that has continuous, vertical glazed clerestories on the north exposures, a flush mounted solar photovoltaic array system on the sloped surfaces, and adheres to the dimensional requirements shown in Figure 2-13.2 [*Lewis Farms Storage Facility Dimension Requirements*].
 - a. The glazed clerestories:
 - i. shall be placed on upstand curbs that are minimum 400 mm high;
 - ii. shall be designed such that glazing is accessible for ongoing maintenance and cleaning (interior and exterior); and
 - iii. may be shaded to mitigate glare;

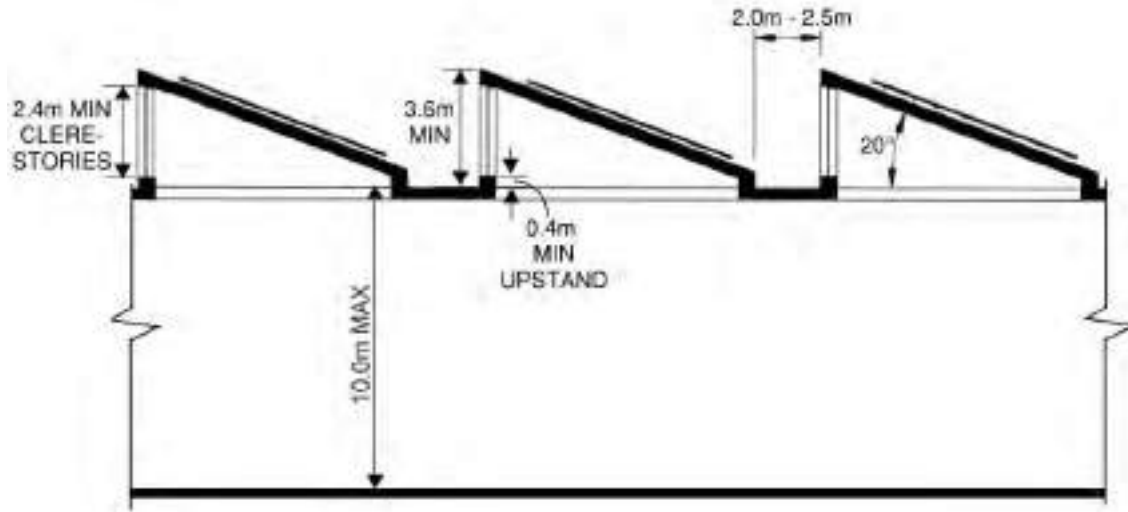

Figure 2-13.2: Lewis Farms Storage Facility Dimension Requirements

3. utilize matte white coloured metal panel wall cladding and roof cladding, with charcoal coloured metal panel accents in the following locations:
 - a. the vertical banding provided between the sawtooth masses on the east and west elevations; and
 - b. the portions of the north elevation that contain the LRV, loading and service doors;
 4. utilize LRV, loading and service doors that are coloured to match the charcoal coloured metal panel accents;
 5. utilize roofing that matches the matte white colour of the exterior, with matching prefinished metal edging, trims and flashings, where required; and
 6. utilize architectural screening to conceal any required rooftop equipment from view.
- C. The roofing materials for the flat areas between the sawtooth masses shall have a minimum initial reflectance of 0.65 and a minimum 3-year aged reflectance of 0.5.
- D. Electric lighting controls shall be integrated to incorporate daylight harvesting.
- E. Ducts and other systems shall be placed to minimize interference with daylight from clerestories.
- F. The design of the Lewis Farms Storage Facility shall:
 1. use landscape, berming and building massing to screen open material storage and soften the industrial function of the site; and
 2. use landscaping to disrupt the south face of the building when viewed from the open space recreational area to the south in accordance with Section 2-14.6.2 [*Lewis Farms Storage Facility*] of this Schedule.
- G. Mechanical heating, ventilation and air conditioning units for the Lewis Farms Storage Facility shall be located on an accessible second level catwalk within the LRV Storage Area.

Section 2-14 – LANDSCAPE ARCHITECTURE

2-14.1 GENERAL

- A. This Section 2-14 [*Landscape Architecture*] sets out Design and Construction requirements for the Landscaped Areas.
- B. The Landscaped Areas shall:
1. be comprised of landscaping that is generally consistent with landscaping as provided on Valley Line LRT Stage 1;
 2. reinstate the functional performance of existing landscaped and natural areas adjacent to the LRT Corridor that are impacted during Construction;
 3. provide a positive experience for neighboring residents, pedestrians, cyclists, drivers, and Passengers;
 4. display a recognizably higher level of landscape architecture than that of typical arterial Roadway corridors in the City;
 5. integrate the Infrastructure into existing neighborhoods;
 6. support the City's SUP and sidewalk network by providing support amenities for pedestrians, cyclists and Passengers; and
 7. maximize the number of trees retained and planted along the LRT Corridor by supporting and integrating the landscape architecture with the Infrastructure design.

2-14.2 LANDSCAPE ARCHITECTURE DESIGN STANDARDS

- A. All landscape architecture design components and layouts within the Landscape Areas shall comply with the requirements, guidelines and standards in the Valley Line West LRT Landscape Design and Construction Standards.

2-14.3 SUSTAINABILITY

- A. The Design and Construction of the Landscaped Areas shall incorporate sustainable best practices to the fullest extents possible by:
1. incorporating the best practices and strategies in accordance with the City of Edmonton Low Impact Development Best Practices Design Guide, and the City of Edmonton Low Impact Development Construction, Inspection & Maintenance Guide; and
 2. providing green infrastructure and sustainable neighborhoods by:
 - a. incorporating tree-lined and shaded streets;
 - b. minimising potable water consumption through integrated rain water management;
 - c. actively reducing the heat island effect; and
 - d. minimising the use of non-certified tropical wood.

2-14.4 LANDSCAPED AREAS

2-14.4.1 Landscape Planting Area Definitions

- A. Figure 2-14.4.1 [*Illustrated Landscaped Area Definitions*] illustrates and defines areas of the Lands along the LRT Corridor which constitute the Landscaped Areas, including the various planting areas that they consist of. These planting areas are referenced throughout this Section 2-14 [*Landscape Architecture*].

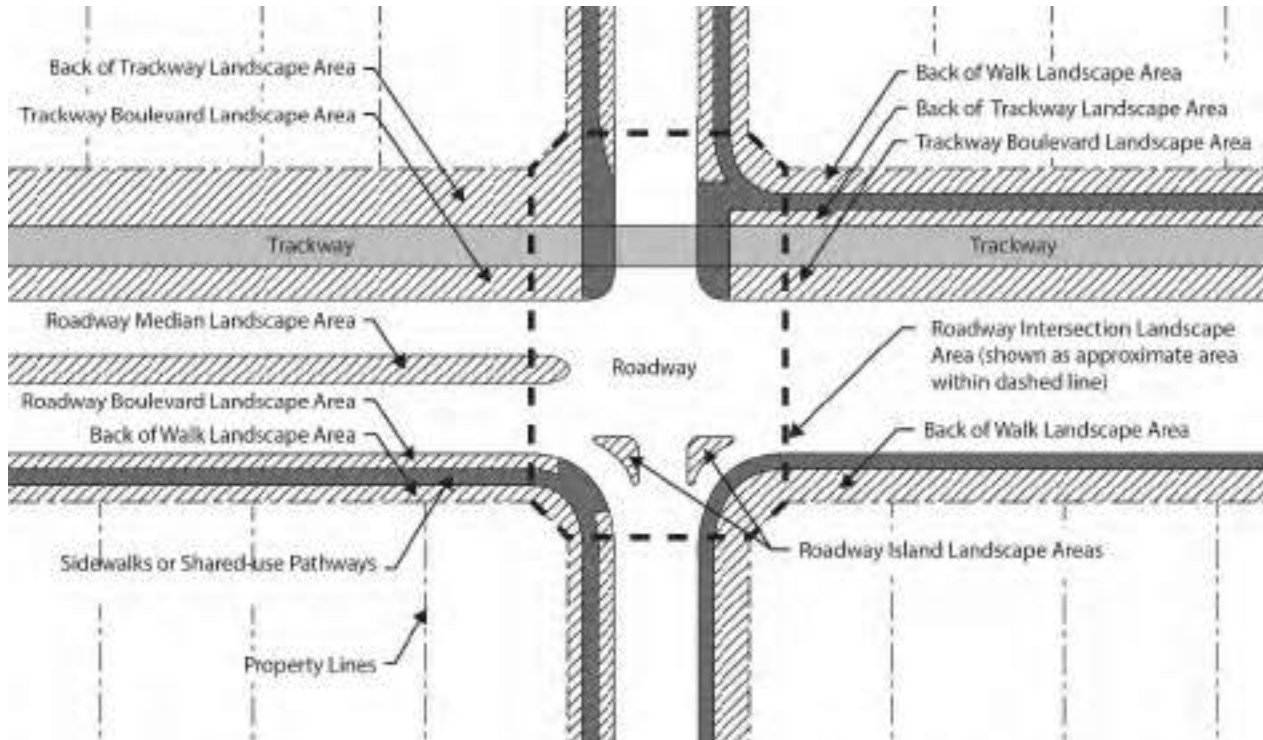

Figure 2-14.4.1: Illustrated Landscaped Area Definitions

2-14.4.2 General Planting Requirements for Landscaped Areas

- A. Table 2-14.4.2 [*Spatial Requirements for Planting*] shows the general spatial requirements for different landscape treatments in Roadway Boulevard Landscape Areas, Roadway Median Landscape Areas, Roadway Island Landscape Areas and Trackway Boulevard Landscape Areas, depending on the boulevard/median width available along the LRT Corridor. Area specific landscape requirements for Roadway Boulevard Landscape Areas, Roadway Median Landscape Areas and Trackway Boulevard Landscape Areas in each Character Zone are set out in Section 2-14.6 [*West Edmonton Character Zone Landscape Requirements*] through Section 2-14.10 [*Downtown Character Zone Landscape Requirements*]. Dimensions specified in Sections 2-14.6 [*West Edmonton Character Zone Landscape Requirements*] to 2-14.10 [*Downtown Character Zone Landscape Requirements*] of this Schedule shall supersede the dimensions specified in Table 2-14.4.2 [*Spatial Requirements for Planting*] of this Schedule.

Table 2-14.4.2: Spatial Requirements for Planting

Boulevard/Median Width	Planting Requirements
Roadway Boulevard Landscape Areas	
≥ 2.6 m width	Street trees, shrub beds and/or boulevard and median plant materials, including concrete verge along the back of curb
≥ 2.6 m width	Street Trees in sod
1.75 - 2.6 m width	Street Trees and/or boulevard and median plant materials in a shrub bed, including concrete verge along the back of curb
1.2 - 1.75 m width	Boulevard and median plant materials, Street Trees in hardscape, or sod
< 1.2 m width	Hardscape only
Trackway Boulevard Landscape Areas	
≥ 6 m or 2 m + ½ width of Canopy Tree at maturity, whichever is greater	Canopy Trees, shrub beds and/or boulevard and median plant materials, including concrete verge
≥ 4.0 m	Columnar Trees, shrub beds and/or boulevard and median plant materials, including concrete verge along the back of curb
≥ 2.0 m	Shrub bed and/or boulevard and median plant materials, including concrete verge
< 2.0 m width	Hardscape only
Roadway Median Landscape Areas and Roadway Island Landscape Areas	
≥ 3.2 m in width	Street Trees, shrub beds and/or boulevard and median plant materials, including concrete verges on both sides of median/island
3.2 m to 2.75 m width	Shrub bed and/or boulevard and median plant materials, including concrete verges on both sides of median/island
< 2.75 m width	Hardscape and/or boulevard and median plant materials, including concrete verges on both sides of median/island

- B. Refer to Section 2-14.29.7 [Tree, Shrub and Perennial Plant Spacing] for typical tree spacing at tree maturity.

- C. Street Trees shall not be provided at intersections, crosswalks or driveways where sightlines are determined to be impeded in accordance with Valley Line West LRT Roadways Design and Construction Standards and the Safety and Security Certification Program.
- D. Where existing Utilities within required setbacks are parallel to, and in direct conflict with, a potential continuous row of Street Trees, the trees shall be reallocated to segments of boulevards, medians, or islands.
- E. Notwithstanding Section 2-14.4.2 [*General Planting Requirements for Landscaped Areas*] of this Schedule, all street lighting power lines conflicting with Street Trees shall be relocated to accommodate Street Tree planting.
- F. Concrete verges, where required, shall adhere to the requirements of Section 2-14.20 [*Verges*] of this Schedule.

2-14.4.3 Street Tree Planting in Roadway Boulevard Landscape Areas

- A. Provide Street Trees in all Roadway Boulevard Landscape Areas as identified in Table 2-14.4.2 [*Spatial Requirements for Planting*] and according to the following requirements:
 - 1. provide Street Trees as required within the Roadway Boulevard Landscape Areas except where:
 - a. an existing tree is located in the applicable Roadway Boulevard Landscape Area, in which case the Street Tree patterning shall accommodate the existing tree; or
 - b. the required setback to a Utility crossing, driveway, walkway, bus pad or Structure prevents tree planting, in which case tree spacing shall be adjusted by up to 3 m to accommodate setbacks. Where two or more setback conflicts overlap or occur concurrently along a section of the LRT Corridor, a maximum of one (1) Street Tree may be omitted from the affected section.
 - 2. Street Trees in the Roadway Boulevard Landscape Area shall be:
 - a. Canopy Trees;
 - b. planted in a continuous row along the full length of the Roadway Boulevard Landscape Area; and
 - c. spaced according to the mature tree canopy sizes listed in Table 2-14.29.3 [*Tree Species for Landscaping*].

2-14.4.4 Street Tree Planting in the Back of Walk Landscape Area

- A. Provide Street Trees in the Back of Walk Landscape Areas according to the following requirements:
 - 1. provide Street Trees as required within the Back of Walk Landscape Area, except where:
 - a. an existing tree is located in the applicable Back of Walk Landscape Area, in which case the Street Tree patterning shall be adjusted to accommodate the existing tree; or
 - b. the required setback to a Utility crossing, driveway, walkway or Structure prevents tree planting, in which case tree spacing shall be adjusted by up to 3 m to accommodate setbacks. Where two or more setback conflicts overlap or occur concurrently along a section of the LRT Corridor, a maximum of one (1) Street Tree may be omitted from the affected section; or
 - c. the Back of Walk Landscape Area width is less than 1.5m, where the width is measured from back of walk to adjacent property line; and

2. Street Trees in the Back of Walk Landscape Area shall be:
 - a. Canopy Trees;
 - b. planted in a continuous row along the full length of the Back of Walk Landscape Area; and
 - c. spaced according to the mature tree canopy sizes listed in Table 2-14.29.3 [*Tree Species for Landscaping*].

2-14.4.5 Street Tree Planting in the Roadway Median and Roadway Island Landscape Area

- A. Provide Street Trees in the Roadway Median Landscape Area and Roadway Island Landscape Area as identified in Table 2-14.4.2 [*Spatial Requirements for Planting*] and according to the following requirements:
 1. provide Street Trees as required within the Roadway Median Landscape Area and Roadway Island Landscape Area, except where:
 - a. an existing tree is located in the applicable Roadway Median Landscape Area or Roadway Island Landscape Area, in which case Street Tree patterning shall be adjusted to accommodate the existing tree; or
 - b. the required setback to a Utility crossing, driveway, walkway or Structure prevents tree planting, in which case tree spacing shall be adjusted by up to 3 m to accommodate setbacks. Where two or more setback conflicts overlap or occur concurrently along a section of the LRT Corridor, a maximum of one (1) Street Tree may be omitted from the affected section; and
 2. Street Trees in the Roadway Median Landscape Area and Roadway Island Landscape Area shall be:
 - a. Canopy Trees;
 - b. planted in a continuous row along the full length of the Roadway Median Landscape Area or Roadway Island Landscape Area; and
 - c. spaced according to the mature tree canopy sizes listed in Table 2-14.29.3 [*Tree Species for Landscaping*].

2-14.4.6 Street Tree Planting in the Trackway Boulevard Landscape Area

- A. Provide Street Trees in the Trackway Boulevard Landscape Area as identified in Table 2-14.4.2 [*Spatial Requirements for Planting*] and according to the following requirements:
 1. provide Street Trees as required within the Trackway Boulevard Landscape Area, except where:
 - a. an existing Street Tree is located in the applicable Trackway Boulevard Landscape Area, in which case Street Tree patterning shall be adjusted to accommodate the existing tree; or
 - b. the required setback to a Utility crossing, driveway, walkway or Structure prevents tree planting, in which case tree spacing shall be adjusted by up to 3 m to accommodate setbacks. Where two or more setback conflicts overlap or occur concurrently along a section of the LRT Corridor, a maximum of one (1) Street Tree may be omitted from the affected section; and
 2. Street Trees in the Trackway Boulevard Landscape Area shall be in accordance with Section 2-14.5 [*Required Planting Setbacks*] of this Schedule and as follows:

- a. provide Canopy Trees within the Trackway Boulevard Landscape Area if the width of the Trackway Boulevard Landscape Area is sufficient to accommodate Canopy Trees; otherwise, provide Columnar Trees within the Trackway Boulevard Landscape Area;
 - i. Canopy Trees shall be planted in a continuous row along the full length of the Trackway Boulevard Landscape Area and spaced according to the mature tree canopy sizes listed in Table 2-14.29.3 [*Tree Species for Landscaping*]; and
 - ii. Columnar Trees shall be planted in groups of at least three (3) trees, with trees being spaced according to the mature tree canopy sizes listed in Table 2-14.29.3 [*Tree Species for Landscaping*], with a 9.0 m maximum space between groups of trees.

2-14.4.7 Pedestrian Priority Zones

- A. The landscape design in all PPZs shall be distinct from other Landscaped Areas along the LRT Corridor, highlighting the applicable Stop(s), Station and immediately adjacent intersection(s). Landscape design differentiation shall be created by modifications in planting patterning, layout design, or foliage and flower colour. Plantings shall provide the effect of colour and texture through all four (4) seasons.

2-14.4.8 Landscape Treatment of Remnant Land Parcels

- A. If a Remnant Land Parcel is a Vacant Lot, implement the landscape provisions of the Character Zones as set out in Section 2-14.6 [*West Edmonton Character Zone Landscape Requirements*] through Section 2-14.10 [*Downtown Character Zone Landscape Requirements*] of this Schedule.
- B. If a Vacant Lot is not identified within the Character Zones requirements as set out in Section 2-14.6 [*West Edmonton Character Zone Landscape Requirements*] through Section 2-14.10 [*Downtown Character Zone Landscape Requirements*] of this Schedule, then for each such Vacant Lot:
 - 1. provide sod;
 - 2. provide wood bumper posts in accordance with Section 2-14.22 [*Wood Bumper Posts*] of this Schedule along the perimeter of the Vacant Lot, conforming to the requirements of Drawing #LA404 of the Valley Line West LRT Landscape Design and Construction Standards, except:
 - a. do not provide wood bumper posts where Landscape Fences are provided;
 - b. do not provide wood bumper posts where vehicular access is required;
 - c. provide chains with locks between wood bumper posts where service access is required; and
 - d. do not provide wood bumper posts along shared property lines where two (2) or more Vacant Lots adjoin one another;
 - 3. provide Landscape Fences in accordance with Section 1-2.2.3 [*Landscape Fences*] of this Schedule along all sides of the Vacant Lots abutting private property;
 - 4. provide a minimum 4.0 m wide shrub bed adjacent to all Landscape Fences where space permits; and
 - 5. all landscaping shall be arranged around and integrated with any existing trees remaining in the Vacant Lot which are determined to be healthy by the Arborist after completing a health assessment.
- C. At Remnant Land Parcels where an existing building is to remain or that have still not been designated as a Vacant Lot following a date that is two (2) years prior to the Target Construction Completion Date:

1. provide landscaping in accordance with Section 2-14.14 [*Isolated Landscape Disturbance*] of this Schedule.

2-14.5 REQUIRED PLANTING SETBACKS

- A. Provide tree, shrub and perennial setbacks to Utilities, property lines, walkways, Roadways, Trackway, SUPs and sidewalks in accordance with the Valley Line West LRT Landscape Design and Construction Standards.
- B. Without limiting Section 2-14.5 [*Required Planting Setbacks*] of this Schedule, provide tree setbacks to Roadways and Trackway in accordance with Table 2-14.5 [*Tree Setbacks*].

Table 2-14.5: Tree Setbacks

Scenario	Tree Setbacks
Between 102 Street and 102 Avenue to 156 Street and 99 Avenue, from Roadways at boulevards and medians	Minimum: 1.25 m Preferred: 1.60 m
Between 156 Street and 99 Avenue to Lewis Farms, from Roadways at boulevards and medians	Minimum: 1.60 m
From the Dynamic Envelope	For Canopy Trees: at least half the width of Canopy Tree at maturity* For Columnar Trees: at least 2 m or half the width of the Columnar Tree at maturity*, whichever is greater, +1 m to allow for service space. *Dimensions of tree at maturity are according to Table 2-14.29.3 [<i>Tree Species and Spread</i>].

- C. All tree setback measurements identified Table 2-14.5 [*Tree Setbacks*] shall be measured from centre of trunk to face of curb.

2-14.6 WEST EDMONTON CHARACTER ZONE LANDSCAPE REQUIREMENTS

2-14.6.1 Lewis Farms Park and Ride

2-14.6.1.1 Location

- A. This Section 2-14.6.1 [*Lewis Farms Park and Ride*] sets out landscape requirements for the Lewis Farms Park and Ride site and surrounding areas.

2-14.6.1.2 Design Intent

- A. The landscaping shall provide a pedestrian focused landscape that highlights pedestrian movement corridors, shades parking and pedestrian areas, and manages water through aesthetically designed Low Impact Development Facilities.

- B. The landscaping shall be contemporary with a bold, geometric design of mass-planted colourful shrub planting blocks.

2-14.6.1.3 Area Specific Requirements

- A. Landscaping is not permitted in the Lewis Farms Temporary Parking Facility within the TUC, except as noted in Section 2-14.6.3.3A.1 [*Area Specific Requirements*] of this Schedule.
- B. Provide the following landscaping in the area east of the Lewis Farms Transit Centre, north of the Trackway, south of Webber Greens Drive and west of Anthony Henday Drive:
 - 1. a minimum of ten (10) Canopy Trees, planted in shrub beds or in grass areas;
 - 2. a minimum of ten (10) ornamental coniferous trees, planted in shrub beds;
 - 3. a minimum of twenty-four (24) deciduous ornamental trees, planted in shrub beds or in grass areas;
 - 4. a minimum of 700 m² of shrub beds, arranged in a park like manner; and
 - 5. sod for the remainder, such that grass areas are contiguous and create useful open spaces.
- C. Provide single rows of Canopy Trees with shrub beds in all Roadway Boulevard Landscape Areas within the Lewis Farms Park and Ride site.
- D. In addition to the requirements of Section 2-14.6.1.3C [*Area Specific Requirements*] of this Schedule, provide single rows of Canopy Trees in the Back of Walk Landscape Area adjacent to all SUPs within the Lewis Farms Park and Ride site except:
 - 1. where Naturalization occurs adjacent to the Muskakosi Natural Area, Canopy Trees may be substituted with trees that are to be planted as part of the Naturalization Area.
- E. Parking lot islands within the Lewis Farms Park and Ride shall be provided with a minimum of one (1) Canopy Tree and shrub beds.
- F. Parking lot end caps within the Lewis Farms Park and Ride shall be provided with a minimum of two (2) Canopy Trees and shrub beds.
- G. Trees within parking areas of the Lewis Farms Park and Ride shall have a minimum 8 m diameter tree canopy width at maturity.
- H. Not Used.
- I. Provide bioswales (Stormwater Management Facilities) within the Lewis Farms Park and Ride site as follows:
 - 1. bioswales shall be part of, or in addition to, the required Landscaped Areas;
 - 2. all bioswales shall have a continuous row of Street Trees; and
 - 3. all bioswales shall have shrub beds.
- J. Provide Naturalization in accordance with the Valley Line West LRT Landscape Design and Construction Standards, to all areas in the Lands at the Lewis Farms Park and Ride site that do not receive other landscape treatments and are not identified as Naturalization Areas or Native Forest Reclamation Areas in Schedule 10 [*Environmental Performance Requirements*].
- K. Provide the following public amenities within the Lewis Farms Park and Ride site:

1. ten (10) benches substantially similar to those provided at the Lewis Farms Stop:
 - a. benches shall be in addition to benches provided for Amenity Nodes; and
 - b. benches shall be installed on a concrete pad and be located adjacent to, but not in, pedestrian through zones; and
 2. eight (8) waste and recycling receptacles substantially similar to those provided at the Lewis Farms Stop:
 - a. waste and recycling receptacles shall be installed on a concrete pad and be located adjacent to, but not in, pedestrian through zones.
- L. Notwithstanding Section 2-14.6.1.3B [*Area Specific Requirements*] of this Schedule, sod is not permitted within the Lewis Farms Park and Ride site.

2-14.6.2 Lewis Farms Storage Facility

2-14.6.2.1 Location

- A. This Section 2-14.6.2 [*Lewis Farms Storage Facility*] sets out landscape requirements for the Lewis Farms Storage Facility site.

2-14.6.2.2 Design Intent

- A. Landscaping, at plant maturity, shall screen views of the Lewis Farms Storage Facility from the communities to the south and from Anthony Henday Drive to the maximum extent possible.
- B. Landscaping shall create useful outdoor spaces for users of the Lewis Farms Storage Facility.
- C. All landscaping on the Lewis Farms Storage Facility site shall be designed to support the LEED® certification of the Lewis Farms Storage Facility.

2-14.6.2.3 Area Specific Requirements.

- A. Provide the following landscaping within the Lewis Farms Storage Facility site:
1. along the south side of the Lewis Farms Storage Facility:
 - a. four (4) Street Trees;
 - b. nine (9) evergreen, coniferous trees; and
 - c. shrub beds;
 2. in the parking areas along the west and north sides of the Lewis Farms Storage Facility site:
 - a. nine (9) Canopy Trees; and
 - b. shrub beds; and
 3. within the non public outdoor spaces of the Lewis Farms Storage Facility:
 - a. shrub beds; and
 - b. sod for the remainder, such that grass areas are contiguous and create useful open spaces.
- B. Provide Naturalization in accordance with the Valley Line West LRT Landscape Design and Construction Standards, to all areas in the Lands at the Lewis Farms Storage Facility site that do not

receive other landscape treatments and are not identified as Naturalization Areas or Native Forest Reclamation Areas in Schedule 10 [*Environmental Performance Requirements*].

2-14.6.3 87 Avenue West

2-14.6.3.1 Location

- A. This Section 2-14.6.3 [*87 Avenue West*] sets out landscape requirements for 87 Avenue from the Lewis Farms Site to Aldergrove Park, including the TUC.

2-14.6.3.2 Design Intent

- A. The landscaping shall reflect the aesthetics of adjacent residential landscapes and open park style landscapes.
- B. Boulevard and median plant materials shall be arranged in large flowing masses.

2-14.6.3.3 Area Specific Requirements

- A. Provide the following landscaping within the TUC:
1. grass in any areas disturbed by Construction conforming to Alberta Transportation's Standard Specifications for Highway Construction.
- B. All landscaping and landscape materials used in the TUC shall conform with Alberta Transportation's Standard Specifications for Highway Construction.
- C. Provide the following landscaping along 87 Avenue from the east boundary of the TUC to 189 Street:
1. single rows of Canopy Trees and shrub beds in the Trackway Boulevard Landscape Areas;
 2. planted medians with 120 m² of shrub beds and a staggered double row of ornamental deciduous trees in the Roadway Median Landscape Areas;
 3. provide a protection fence to the portions of the lots that back onto the Infrastructure along the south side of 87 Avenue from Lot 14, Block 70 through to Lot 7, Block 71, as required in accordance with Section 2-4.5.5 [*Special Protection Fence*] of this Schedule; and
 4. Utility Complex Landscaping in accordance with Section 2-14.12 [*Utility Complex Site Landscaping*] of this Schedule at W279, as set out in Schedule 14 [*City Lands*].
- D. Provide the following landscaping along 87 Avenue from 189 Street to Decoteau Trail:
1. a single row of Canopy Trees and shrub beds in the Back of Walk Landscape Areas along the north side of 87 Avenue;
 2. Canopy Trees and shrub beds in the Roadway Boulevard Landscape Area;
 3. Street Trees and shrub beds in the Roadway Median Landscape Area;
 4. a minimum of 110 Columnar Trees and shrub beds in the Trackway Boulevard Landscape Area along the north side of the Trackway;
 5. sod in the Trackway Boulevard Landscape Area along the south side of the Trackway;
 6. a single row of Street Trees and a minimum of 1000 m² of shrub beds in the Back of Walk Landscape Areas along the south side of 87 Avenue;

7. at W262, as set out in Schedule 14 [*City Lands*]:
 - a. a minimum 4 m wide shrub bed along the length of each property line, arranged in a curvilinear form;
 - b. a minimum of three (3) Canopy Trees, arranged in groups within grass spaces;
 - c. a minimum of three (3) ornamental coniferous trees, arranged towards the property lines within shrub beds;
 - d. a minimum of ten (10) deciduous ornamental trees, arranged in a colonnade along the walk;
 - e. Landscape Fences in accordance with Section 1-2.2.3 [*Landscape Fences*] of this Schedule along the north and south sides of the lot; and
 - f. sod, such that grass areas are contiguous and create useful open spaces; and
8. to the east of W262, as set out in Schedule 14 [*City Lands*]:
 - a. a minimum 4 m wide shrub bed along the length of the property line, arranged in a curvilinear form;
 - b. a minimum 2 m wide shrub bed arranged around the Amenity Node;
 - c. a minimum of six (6) deciduous trees, arranged in clusters in a park like manner;
 - d. a minimum of five (5) coniferous trees located near the property lines within shrub beds; and
 - e. sod, such that grass areas are contiguous and create useful open spaces.

2-14.6.3.4 Intersection Specific Requirements

- A. Without limiting the requirements of Section 2-14.6.3.3 [*Area Specific Requirements*] of this Schedule, this Section 2-14.6.3.4 [*Intersection Specific Requirements*] provides the landscape requirements for intersections along 87 Avenue from Lewis Farms to Aldergrove Park.
- B. At the intersection of 87 Avenue and 182 Street:
 1. in the northwest corner of the Back of Walk Landscape Area, provide a minimum 100 m² of shrub beds; and
 2. in the northeast corner of the Back of Walk Landscape Area, provide a minimum 75 m² of shrub beds.

2-14.6.4 Aldergrove Park

2-14.6.4.1 Location

- A. This Section 2-14.6.4 [*Aldergrove Park*] sets out landscape requirements for Aldergrove Park within the area of W209, as set out in Schedule 14 [*City Lands*].

2-14.6.4.2 Design Intent

- A. The landscaping shall integrate with and improve upon the existing landscape in Aldergrove Park.

2-14.6.4.3 Area Specific Requirements

- A. Provide the following landscaping at Aldergrove Park:

1. at W209, as set out in Schedule 14 [*City Lands*]:
 - a. a minimum of twelve (12) Canopy Trees, arranged in a continuous row along the east to west walk;
 - b. a minimum 60 m² shrub bed; and
 - c. sod, such that grass areas are contiguous and create useful open spaces; and
 2. at the south side of the 87 Avenue Elevated Guideway Ramp in the Back of Walk Landscape Area:
 - a. a minimum of fifty-four (54) Columnar Trees; and
 - b. a minimum 300 m² shrub bed.
- B. Provide Utility Complex landscaping in accordance with Section 2-14.12 [*Utility Complex Site Landscaping*] of this Schedule.
- C. New landscaping shall not disrupt the normal function of the existing Aldergrove Park Stormwater Management Facility.
- D. New landscaping shall not disrupt the normal function of the existing sports fields.

2-14.6.5 Under Guideway Landscape Area Special Requirements

2-14.6.5.1 Location

- A. Section 2-14.6.5 [*Under Guideway Landscape Area Special Requirements*] sets out landscape requirements for the area below the 87 Avenue Elevated Guideway (denoted as the “Under Guideway Landscape Area”).
- B. The landscaping in the Under Guideway Landscape Area shall conform to the requirements of this Section 2-14.6.5 [*Under Guideway Landscape Area Special Requirements*] of this Schedule, the drawings in Appendix 5-2C [*Under Guideway Landscape Area Drawings*] of this Schedule and to the Valley Line West LRT Design Guide.
- C. In the event of any conflict, ambiguity or inconsistency between or among the requirements of this Section 2-14.6.5 [*Under Guideway Landscape Area Special Requirements*] and any other provision of the Project Agreement, the requirements of this Section 2-14.6.5 [*Under Guideway Landscape Area Special Requirements*] shall prevail.

2-14.6.5.2 Design Intent

- A. Provide a landscape design that creates public amenities and responds to the unique sun, snow and rain shadow areas of the Under Guideway Landscape Area.
- B. Mitigate CPTED concerns through creative landscape design and lighting.
- C. Lighting shall highlight desirable landscape, architectural, and structural features.
- D. Landscaping shall screen adjacent privately-owned parking areas from pedestrian areas and the Roadway to the maximum extent possible.
- E. Plant materials shall be designed to be passively irrigated by exclusively using rainwater runoff from the 87 Avenue Elevated Guideway and naturally occurring rain fall.

2-14.6.5.3 Area Specific Requirements

- A. Roadway Boulevard Landscape Areas and Back of Walk Landscape Areas shall be composed of the following, at a minimum, in accordance with Appendix 5-2C [*Under Guideway Landscape Area Drawings*] of this Schedule:
1. plant materials in accordance with Section 2-14.6.5.3H [*Area Specific Requirements*] of this Schedule;
 2. maintenance pathways in accordance with Section 2-14.6.5.3F [*Area Specific Requirements*] of this Schedule;
 3. rock mulch;
 4. boulders in accordance with Section 2-14.6.5.3G [*Area Specific Requirements*] of this Schedule;
 - a. provide a minimum of sixty (60) boulders, each of which shall measure at least 1 m at their smallest dimension, and a minimum of one hundred and eighty (180) boulders, each of which shall measure at least 0.5 m at their smallest dimension;
 5. passive irrigation systems in accordance with Section 2-14.6.5.3C [*Area Specific Requirements*] of this Schedule; and
 6. other amenities as identified on the drawings in Appendix 5-2C [*Under Guideway Landscape Area Drawings*].
- B. Roadway Median Landscape Areas shall be composed of the following, at a minimum, in accordance with Appendix 5-2C [*Under Guideway Landscape Area Drawings*] of this Schedule:
1. plant materials in accordance with Section 2-14.6.5.3H [*Area Specific Requirements*] of this Schedule;
 2. maintenance pathways in accordance with Section 2-14.6.5.3F [*Area Specific Requirements*] of this Schedule;
 3. rock mulch;
 4. boulders in accordance with Section 2-14.6.5.3G [*Area Specific Requirements*] of this Schedule;
 - a. provide a minimum of forty (40) boulders, each of which shall measure at least 1 m at their smallest dimension, and a minimum of one hundred and twenty (120) boulders, each of which shall measure at least 0.5 m at their smallest dimension;
 5. passive irrigation systems in accordance with Section 2-14.6.5.3C [*Area Specific Requirements*] of this Schedule; and
 6. other amenities as identified on the drawings in Appendix 5-2C [*Under Guideway Landscape Area Drawings*].
- C. Passive irrigation systems in the Under Guideway Landscape Area shall be composed of the following, at a minimum, in accordance with Appendix 5-2C [*Under Guideway Landscape Area Drawings*] of this Schedule:
1. a Permavoid™ capillary action sub-surface drainage system, or alternate acceptable to the City, each location of the capillary action drainage system shall:
 - a. not physically attach to the Elevated Guideway drainage downspouts described in Section 2-9.6D [*Drainage*] of this Schedule;

- b. provide convenient access for the clean out of all Elevated Guideway drainage and passive irrigation system components;
- c. incorporate a concrete catch basin with a steel grate lid that measures at least 600 mm in diameter to allow for maintenance access and is capable of grit collection;
- d. incorporate a concrete splash pad that is designed to allow overflow of stormwater into the adjacent landscaping, dissipates storm water energy and minimize erosion;
- e. include a sedimentation area which includes a double layer of Structural Soil Cells for sedimentation collection and includes a cleanout port with a lockable cap that measures at least 600 mm in diameter to allow for maintenance access;
- f. include at least one (1) layer of Structural Soil Cells for passive irrigation and stormwater collection;
- g. include appropriate wicking geotextiles, capillary cylinders, waterproof membranes, and separation geotextiles to provide capillary action water migration between the soil media and the Structural Soil Cell system;
- h. include a waterproof geomembrane underneath and along the sides of the passive irrigation system;
- i. incorporate depressed landscaped areas around the concrete splash pad to collect stormwater overflow:
 - i. depressed landscaped areas shall be between 150 mm and 200 mm lower than adjacent grades; and
 - ii. depressed landscaped areas shall cover between 65% and 80% of the passive irrigation system area; and
- j. include a controlled discharge outlet pipe that connects to the City's Stormwater Management System:
 - i. the outlet pipe shall be PVC pipe that measures at least 200 mm in diameter and uses 90 degree, long radius bends to connect with adjacent drainage catch basins; and
 - ii. the connection to the City's Stormwater Management System shall comply with the access and clean out requirements in the EPCOR Water Service Inc. (Drainage) July 2020 LID Design Standards; and
- k. use soils to support capillary irrigation of plan material:
 - i. soil media shall be capable of maintaining consistent moisture levels at the root zones of plant material;
 - ii. soils for the application shall be selected in accordance with the manufacturer's written instructions;
 - iii. soils for the application shall be selected in accordance with the EPCOR Water Service Inc. (Drainage) July 2020 LID Design Standards; and
 - iv. soil depths shall be between 450 mm and 1000 mm; and
- l. be setback from sidewalks and SUPs by a minimum of 1 m;
- m. be setback from Roadways by a minimum of 1.5 m;

- n. be designed to appropriately distribute run off from each Elevated Guideway pier; and
 - o. dissipate all anticipated peak runoff amounts from each Elevated Guideway pier;
2. overland stormwater flows shall be directed away from pedestrian and maintenance pathways, unless stormwater is passed below pedestrian and maintenance pathways in contained channels;
 3. overland stormwater shall not pond on pedestrian or maintenance pathways;
 4. be coordinated with Utility Companies such that:
 - a. where Utilities are pre-existing, setback Structural Soil Cells at least 1.5 m from any buried utility with a series of connecting drainage pipes:
 - i. drainage pipes shall be at least 200 mm in diameter; and
 - b. where Utility relocations are required, relocated Utilities shall not be permitted within the zones identified for the capillary action sub-surface drainage system; and
 - c. they are registered as buried Utilities with the City.
- D. Provide benches and seat walls as follows, in accordance with Appendix 5-2C [*Under Guideway Landscape Area Drawings*] of this Schedule:
1. benches:
 - a. bench types shall be selected in accordance with the Stop PI Theme of the nearest Stop or Station;
 2. integrated planting beds that are surrounded with concrete seat walls complete with permanent, durable wood seating such that:
 - a. planting beds and seat walls are accessible to pedestrians; and
 - b. each seat wall shall accommodate seating for a minimum of six (6) persons.
- E. Provide walkways and plazas in accordance with Appendix 5-2C [*Under Guideway Landscape Area Drawings*] of this Schedule, which shall:
1. be concrete; and
 2. be located a minimum of 2.0 m away from all 87 Avenue Elevated Guideway piers and other Structures.
- F. Provide maintenance pathways to allow for maintenance and inspection of each of the 87 Avenue Elevated Guideway pier, which shall:
1. be at least 1.8 m wide;
 2. be designed for and accommodate all anticipated vehicle loads; and
 3. connect with SUPs and walkways in a subtle manner that minimizes the appearance of the maintenance pathways.
- G. Boulders provided within the Under Guideway Landscape Area shall:
1. be placed individually, or in groups, in locations that best enhance the appearance of the Under Guideway Landscape Area;

2. not be placed within 5.0 m of an 87 Avenue Elevated Guideway pier; and
3. not be placed on top of the passive irrigation system

H. Plant materials provided within the Under Guideway Landscape Area:

1. shall be designed and arranged to create useful, practical open spaces; and
2. may be designed such that it can be removed to allow for future, occasional, maintenance access; and
3. trees shall not be placed within passive irrigation systems.

2-14.6.6 87 Avenue from 182 Street to 178 Street

2-14.6.6.1 Location

- A. This Section 2-14.6.6 [87 Avenue from 182 Street to 178 Street] sets out landscape requirements for 87 Avenue from 182 Street to 178 Street, excluding the Under Guideway Landscape Area as described in Section 2-14.6.5 [Under Guideway Landscape Area Special Requirements] of this Schedule.

2-14.6.6.2 Design Intent

- A. The landscaping is intended to screen views of the 87 Avenue Elevated Guideway from the adjacent private residences.
- B. Boulevard and median plant materials shall be arranged in large flowing masses.

2-14.6.6.3 Area Specific Requirements

- A. Provide the following landscaping along 87 Avenue from 182 Street to 178 Street:
1. a single row of Street Trees and shrub beds in the Back of Walk Landscape Areas along the north side of 87 Avenue;
 2. a single row of Canopy Trees and shrubs beds in the Roadway Boulevard Landscape Area;
 3. a single row of Street Trees and shrubs beds in the Roadway Median Landscape Area; and
 4. trees and shrub beds in the Back of Walk Landscape Areas along the south side of 87 Avenue shall be comprised of a planting mix that is 70% coniferous trees and 30% deciduous ornamental trees to provide landscape screening.

2-14.6.7 87 Avenue from 178 Street to 170 Street

2-14.6.7.1 Location

- A. This Section 2-14.6.7 [87 Avenue from 178 Street to 170 Street] sets out landscape requirements for 87 Avenue from 178 Street to 170 Street, excluding the Under Guideway Landscape Area as described in Section 2-14.6.5 [Under Guideway Landscape Area Special Requirements] of this Schedule.

2-14.6.7.2 Design Intent

- A. The landscaping is intended to screen the views of the 87 Avenue Elevated Guideway from the adjacent private residences.
- B. Boulevard and median plant materials shall be arranged in large flowing masses.

2-14.6.7.3 Area Specific Requirements

- A. Provide the following landscaping along 87 Avenue from 178 Street to 175 Street:
 - 1. sod in the Back of Walk Landscape Areas along the north side of 87 Avenue;
 - 2. a single row of Canopy Trees and shrub beds in the Roadway Boulevard Landscape Area along the north side of 87 Avenue;
 - 3. a single row of Canopy Trees and shrub beds in the Roadway Boulevard Landscape Area along the south side of 87 Avenue; and
 - 4. trees and shrub beds in the Back of Walk Landscape Areas along the south side of 87 Avenue.
- B. Provide the following landscaping along 87 Avenue from 175 Street to the West Edmonton Mall entrance east of WEM Transit Centre:
 - 1. a single row of Canopy Trees and shrub beds in the Roadway Boulevard Landscape Area along the north side of 87 Avenue; and
 - 2. sod in the Roadway Boulevard Landscape Area along the south side of 87 Avenue.
- C. Provide the following landscaping along 87 Avenue from the West Edmonton Mall entrance east of WEM Transit Centre, to 170 Street:
 - 1. Street Trees or rows of ornamental deciduous trees and shrub beds in the Roadway Median Landscape Area;
 - 2. sod in the Roadway Boulevard Landscape Area along the south side of 87 Avenue; and
 - 3. sod in the Back of Walk Landscape Areas along the south side of 87 Avenue.
- D. Provide the following landscaping along 170 Street north and south of 87 Avenue:
 - 1. sod in Roadway Boulevard Landscape Areas.
- E. Provide the following landscaping along 87 Avenue from 170 Street to Misericordia Station:
 - 1. a row of Street Trees or rows of ornamental deciduous trees and at least 500 m² of shrub beds in the Roadway Boulevard Landscape Area on the south side of the Misericordia Hospital parking lot;
 - 2. a row of Canopy Trees and shrub beds in the Roadway Boulevard Landscape Area along the north side of 87 Avenue;
 - 3. Street Trees or rows of ornamental deciduous trees and shrub beds in the Roadway Median Landscape Area; and
 - 4. a single row of Canopy Trees and shrub beds in the Roadway Boulevard Landscape Area along the south side of 87 Avenue.

2-14.6.7.4 Intersection Specific Requirements

- A. Without limiting Section 2-14.6.7.3 [*Area Specific Requirements*] of this Schedule, this Section 2-14.6.7.4 [*Intersection Specific Requirements*] provides landscape requirements for intersections along 87 Avenue from 178 Street to 170 Street.
- B. At the intersection of 87 Avenue and 178 Street:

1. in the northwest corner in the Back of Walk Landscape Area, provide a minimum 200 m² of shrub beds;
 2. in the northwest corner in the Roadway Boulevard Landscape Area, provide sod;
 3. in the northeast corner in the Back of Walk Landscape Area, provide a minimum 120 m² of shrub beds;
 4. in the northeast corner in the Roadway Boulevard Landscape Area, provide sod;
 5. in the southeast corner in the Back of Walk Landscape Area, provide 8 Coniferous Trees and a minimum 250 m² of shrub beds;
 6. in the southeast corner in the Roadway Boulevard Landscape Area, provide Canopy Trees and shrub beds;
 7. in the southeast corner intersection island, provide a minimum 17 m² shrub and perennial bed and a minimum 40 m² shrub and perennial bed;
 8. in the southwest corner intersection island, provide a minimum 16 m² shrub bed; and
 9. in the southwest corner in the Back of Walk Landscape Area, provide 12 Coniferous Trees and a minimum 450 m² shrub bed.
- C. At the intersection of 87 Avenue and 175 Street:
1. in the southeast corner in the Back of Walk Landscape Area, provide sod;
 2. in the southwest corner in the Back of Walk Landscape Area, provide sod; and
 3. at W259, as set out in Schedule 14 [*City Lands*]:
 - a. a minimum 4 m wide shrub bed along the private property lines;
 - b. sod; and
 - c. wood bumper posts to the north and west sides of the lot.
- D. At the intersection of 87 Avenue and 172 Street:
1. in the southeast corner in the Back of Walk Landscape Area, provide sod;
 2. in the southwest corner in the Back of Walk Landscape Area, provide sod; and
 3. at W260, as set out in Schedule 14 [*City Lands*]:
 - a. a minimum 4 m wide shrub bed along the private property lines;
 - b. sod; and
 - c. wood bumper posts to the north and east sides of the lot.
- E. At the intersection of 87 Avenue and 170 Street:
1. in the northwest corner in the Roadway Boulevard Landscape Area along 170 Street, provide a minimum 125 m² shrub bed, and a minimum of eight (8) trees;

2. in the northeast corner in the Roadway Boulevard Landscape Area along 170 Street, provide a minimum 90 m² shrub bed and a minimum of eight (8) trees;
3. in the southeast corner in the Back of Walk Landscape Area, provide three (3) trees and a minimum 100 m² shrub bed; and
4. in the southwest corner in the Back of Walk Landscape Area, provide three (3) trees and a minimum 100 m² shrub bed.

2-14.6.8 Misericordia Hospital Landscape Area

2-14.6.8.1 Location

- A. This Section 2-14.6.8 [*Misericordia Hospital Landscape Area*] sets out landscape requirements for the Misericordia Site, excluding the Under Guideway Landscape Area as described in Section 2-14.6.5 [*Under Guideway Landscape Area Special Requirements*] of this Schedule.

2-14.6.8.2 Design Intent

- A. The landscaping shall substantially restore the existing landscaping found in areas near the Misericordia Hospital.

2-14.6.8.3 Area Specific Requirements

- A. Replace any disturbed landscaping like-for-like.
- B. Replace any disturbed fences like-for-like, including along:
 1. the south side of the Misericordia Hospital helipad; and
 2. the south of Capital Care McConnell Place West.
- C. Provide Utility Complex landscaping in accordance with Section 2-14.12 [*Utility Complex Site Landscaping*] of this Schedule.

2-14.6.9 87 Avenue East

2-14.6.9.1 Location

- A. This Section 2-14.6.9 [*87 Avenue East*] sets out landscape requirements for 87 Avenue from Misericordia Hospital to Meadowlark Road, excluding the Under Guideway Landscape Area as described in Section 2-14.6.5 [*Under Guideway Landscape Area Special Requirements*] of this Schedule.

2-14.6.9.2 Design Intent

- A. The landscaping shall retain and build upon the existing 1960s suburban residential typology of the area.
- B. Boulevard and median plant materials shall be arranged in large flowing masses.

2-14.6.9.3 Area Specific Requirements

- A. Provide the following landscaping along 87 Avenue from 170 Street to 165 Street:
 1. a single row of Canopy Trees and shrub beds in the Roadway Boulevard Landscape Area along the south side of 87 Avenue; and
 2. sod in the Back of Walk Landscape Areas along the south side of 87 Avenue.

- B. Provide the following landscaping along 87 Avenue from 165 Street to 163 Street:
 - 1. a single row of trees and sod in the Back of Walk Landscape Areas on the north side of 87 Avenue; and
 - 2. shrub beds and Columnar Trees along the south side of the Trackway in the Trackway Boulevard Landscape Area.
- C. Provide the following landscaping along 87 Avenue from 163 Street to 159 Street:
 - 1. a single row of Canopy Trees and sod in the Back of Walk Landscape Areas along the north side of 87 Avenue;
 - 2. a single row of Canopy Trees and shrub beds in the Roadway Boulevard Landscape Area along the south side of 87 Avenue; and
 - 3. a single row of Street Trees and sod in the Back of Walk Landscape Areas on the south side of 87 Avenue.

2-14.6.9.4 Intersection Specific Requirements

- A. Without limiting Section 2-14.6.9.3 [*Area Specific Requirements*] of this Schedule, this Section 2-14.6.9.4 [*Intersection Specific Requirements*] provides landscape requirements for intersections along 87 Avenue from Misericordia Hospital to Meadowlark Road.
- B. At the intersection of 87 Avenue and 164 Street:
 - 1. in the southeast corner in the Back of Walk Landscape Areas, provide sod;
 - 2. in the southwest corner in the Roadway Boulevard Landscape Area, provide a minimum 5 m² of shrub bed; and
 - 3. in the southwest corner in the Back of Walk Landscape Areas, provide sod.
- C. At the intersection of 87 Avenue and 163 Street:
 - 1. in the northwest corner in the Roadway Boulevard Landscape Area, provide a minimum of two (2) ornamental deciduous trees and a minimum 125 m² of shrub beds; and
 - 2. in the northeast corner in the Roadway Boulevard Landscape Area, provide a minimum of two (2) ornamental deciduous trees and a minimum 125 m² of shrub beds.
- D. At the intersection of 87 Avenue and 159 Street:
 - 1. in the northeast corner in the Back of Walk Landscape Area, provide a minimum 50 m² shrub bed;
 - 2. in the Roadway Median Landscape Areas east of 159 Street/Meadowlark Road on 87 Avenue, provide a minimum 160 m² shrub bed;
 - 3. in the Roadway Median Landscape Areas south of 87 Avenue on 159 Street, provide a minimum of 3 Street Trees and a minimum 230 m² shrub bed; and
 - 4. in the southwest corner in the Roadway Boulevard Landscape Area, provide a minimum 40 m² shrub bed.

2-14.7 MEADOWLARK PARK CHARACTER ZONE LANDSCAPE REQUIREMENTS

2-14.7.1 Meadowlark Park Area

2-14.7.1.1 Location

- A. This Section 2-14.7.1 [*Meadowlark Park Area*] sets out landscape requirements for the Meadowlark Stop and surrounding area along Meadowlark Road from 87 Avenue to 91 Avenue.

2-14.7.1.2 Design Intent

- A. Landscaping shall restore and build upon the existing 1960s suburban residential typology of the Meadowlark Park area.
- B. In areas near the Jasper Place Library, design the landscape so that the design compliments the existing landscaping found near the library.
- C. Boulevard and median plant materials shall be arranged in large flowing masses.

2-14.7.1.3 Area Specific Requirements

- A. Provide the following landscaping along Meadowlark Road from 87 Avenue to 88A Avenue:
1. a single row of trees and sod in the Back of Walk Landscape Areas along the west side of Meadowlark Road;
 2. a single row of Canopy Trees and shrub beds in the Roadway Boulevard Landscape Area along the east side of Meadowlark Road; and
 3. sod in the Back of Walk Landscape Areas along the east side of 156 Street.
- B. Provide the following landscaping along Meadowlark Road from 88A Avenue to 88BA Avenue:
1. shrubs in shrub beds in the Roadway Boulevard Landscape Area along the north side of Meadowlark Road;
 2. a single row of Canopy Trees with tree grates and Soil Cells in the Roadway Boulevard Landscape Area along the south side of Meadowlark Road; and
 3. shrub beds may be provided in lieu of tree grates in Roadway Boulevard Landscape Areas where there is sufficient hard surface area between Canopy Trees to accommodate all required bike racks, fire access, signage and other furnishings.
- C. Provide the following landscaping along Meadowlark Road from 88B Avenue to 89 Avenue:
1. sod in the Back of Walk Landscape Areas along the north side Meadowlark Road;
 2. shrub beds in the Roadway Boulevard Landscape Area along the north side of Meadowlark Road;
 3. ornamental deciduous trees in Soil Cells with tree grates in the Trackway Boulevard Landscape Area;
 4. shrubs in a minimum 7 m² shrub bed along the south side of the Trackway Boulevard Landscape Area;
 5. a single row of trees and shrub beds in the Roadway Boulevard Landscape Area along the south side of Meadowlark Road; and

6. Utility Complex landscaping in accordance with Section 2-14.12 [*Utility Complex Site Landscaping*] of this Schedule at W263, as set out in Schedule 14 [*City Lands*].
- D. Provide the following landscaping along Meadowlark Road from 89 Avenue to 90 Avenue:
 1. sod in the Back of Walk Landscape Areas along the north side Meadowlark Road; and
 2. a single row of trees and shrub beds in the Roadway Boulevard Landscape Area along the south side of Meadowlark Road.
 - E. Provide the following landscaping along Meadowlark Road from 90 Avenue to 156 Street:
 1. sod in the Back of Walk Landscape Areas along the north side Meadowlark Road; and
 2. shrub beds in the Roadway Boulevard Landscape Area along the south side of Meadowlark Road.
 - F. Provide the following landscaping along Meadowlark Road from 156 Street to 91 Avenue:
 1. a single row of trees and shrub beds in the Back of Walk Landscape Area along the north side of Meadowlark Road; and
 2. a single row of trees and shrub beds in the Roadway Boulevard Landscape Area along the south side Meadowlark Road.

2-14.7.1.4 Intersection Specific Requirements

- A. Without limiting Section 2-14.7.1.3 [*Area Specific Requirements*] of this Schedule, this Section 2-14.7.1.4 [*Intersection Specific Requirements*] provides the landscape requirements for intersections along Meadowlark Road from 87 Avenue to 91 Avenue.
- B. At the intersection of 89 Avenue and Meadowlark Road:
 1. in the northeast corner in the Back of Walk Landscape Area, provide sod;
 2. in the southeast corner (facing 89 Avenue) in the Roadway Boulevard Landscape Area, provide sod; and
 3. in the northwest corner (facing Meadowlark Road) in the Roadway Boulevard Landscape Area, provide a minimum 8 m² shrub bed.
- C. At the intersection of 90 Avenue and Meadowlark Road:
 1. in the southeast corner in the Back of Walk Landscape Area, provide shrub beds and/or sod to best compliment the existing landscaping surrounding the Jasper Place Library.

2-14.7.2 156 Street

2-14.7.2.1 Location

- A. This Section 2-14.7.2 [*156 Street*] sets out landscape requirements for 156 Street from 91 Avenue to 100 Avenue.

2-14.7.2.2 Design Intent

- A. To enhance the pedestrian feel of 156 Street through the incorporation of separated sidewalks and heavily planted boulevards.
- B. Boulevard and median plant materials shall be arranged in large flowing masses.

2-14.7.2.3 Area Specific Requirements

- A. Provide the following landscaping along 156 Street from 91 Avenue to 92 Avenue:
1. a single row of trees in the Back of Walk Landscape Area along the west side of 156 Street;
 2. a single row of trees and sod in the Roadway Median Area along the west side of 156 Street; and
 3. a single row of trees and shrub beds in the Roadway Boulevard Landscape Area along the east side of 156 Street.
- B. Provide the following landscaping along 156 Street from 92 Avenue to 93A Avenue:
1. a single row of trees and sod in the Back of Walk Landscape Area along the west side of 156 Street; and
 2. a single row of trees and shrub beds in the Roadway Boulevard Landscape Area along the east side of 156 Street.
- C. Provide the following landscaping along 156 Street from 93A Avenue to mid-block between 94 Avenue and 95 Avenue:
1. a single row of trees and sod in the Back of Walk Landscape Area along the west side of 156 Street, up to W27 as set out in Schedule 14 [*City Lands*]; and
 2. a single row of trees and shrub beds in the Roadway Boulevard Landscape Area along the east side of 156 Street up to W39 as set out in Schedule 14 [*City Lands*].
- D. Provide the following landscaping along 156 Street from mid-block between 94 Avenue to 95 Avenue:
1. Utility Complex Landscaping in accordance with Section 2-14.12 [*Utility Complex Site Landscaping*] of this Schedule at W27 and W28, as set out in Schedule 14 [*City Lands*];
 2. ornamental deciduous trees in Soil Cells with tree grates in the Trackway Boulevard Landscape Area along the west side of 156 Street;
 3. a single row of Canopy Trees with tree grates and Soil Cells in the Roadway Boulevard Landscape Area along the west side of 156 Street. Where trees are located directly across from a Stop they shall be set back from the non-trackside Platform edge a minimum of 6.5 m to center of trunk;
 4. shrub beds may be provided in lieu of Tree Grates in Roadway Boulevard Landscape Areas where there is sufficient hard surface area between Canopy Trees to accommodate all required bike racks, fire access, signage and other furnishings; and
 5. At W33 through to W36, as set out in Schedule 14 [*City Lands*]:
 - a. sod;
 - b. wood bumper posts along the perimeter of each lot or group of lots where two (2) or more lots are adjacent to each other; and
 - c. at W34, a paved area to accommodate covered bike parking.
- E. Provide a single row of Canopy Trees with tree grates and Soil Cells in the Roadway Boulevard Landscape Area on the east side of 156 Street at W39, W40 and W41 as set out in Schedule 14 [*City Lands*].
- F. Provide the following landscaping along 156 Street from 95 Avenue to 96 Avenue:

1. a single row of trees and shrub beds in the Roadway Boulevard Landscape Area along the west side of 156 Street;
 2. ornamental deciduous trees in Soil Cells with tree grates in the Trackway Boulevard Landscape Area along the east side of 156 Street;
 3. ornamental deciduous trees in Soil Cells with tree grates in the Trackway Boulevard Landscape Area along the east side of 156 Street;
 4. a single row of Canopy Trees with tree grates and Soil Cells in the Roadway Boulevard Landscape Area along the east side of 156 Street. Where trees are located directly across from a Stop they shall be set back from the non-trackside Platform edge a minimum of 6.5 m to center of trunk; and
 5. shrub beds may be provided in lieu of tree grates in Roadway Boulevard Landscape Areas where there is sufficient hard surface area between Canopy Trees to accommodate all required bike racks, fire access, signage and other furnishings.
- G. Provide the following landscaping along 156 Street from 96 Avenue to 98 Avenue:
1. a single row of trees and shrub beds in the Roadway Boulevard Landscape Area along the east side of 156 Street.
- H. Provide the following landscaping along 156 Street from 98 Avenue to 99 Avenue:
1. a single row of Canopy Trees and shrub beds in the Roadway Boulevard Landscape Area along the west side of 156 Street; and
 2. a single row of Canopy Trees and shrub beds in the Roadway Boulevard Landscape Area along the east side of 156 Street.
- I. Provide the following landscaping along 156 Street from 99 Avenue to 100 Avenue:
1. a single row of Canopy Trees and sod in the Back of Walk Landscape Area along the west side of 156 Street;
 2. shrub beds in the Back of Trackway Landscape Area along the west side of 156 Street; and
 3. a single row of Canopy Trees and shrub beds in the Roadway Boulevard Landscape Area along the east side of 156 Street.

2-14.7.2.4 Intersection Specific Requirements

- A. Without limiting Section 2-14.7.2.3 [*Area Specific Requirements*] of this Schedule, this Section 2-14.7.2.4 [*Intersection Specific Requirements*] provides the landscape requirements for intersections along 156 Street from 91 Avenue to 100 Avenue.
- B. At the intersection of 156 Street and 91 Avenue:
1. on the west side of 156 Street, just north of 91 Avenue, provide a minimum of 80 m² of shrub/perennial beds.
- C. At the intersection of 156 Street and 92 Avenue:
1. in the northwest corner in the Back of Walk Landscape Area, provide a minimum 100 m² of shrub/perennial beds;
 2. in the northwest corner along 156 Street in the Roadway Boulevard Landscape Area, provide a minimum 10 m² of shrub/perennial beds;

3. in the northwest corner along 92 Avenue in the Roadway Boulevard Landscape Area, provide three (3) Street Trees and sod;
 4. in the southeast corner along 92 Avenue in the Roadway Boulevard Landscape Area, provide three (3) Street Trees and shrub beds; and
 5. in the southwest corner along 92 Avenue in the Roadway Boulevard Landscape Area, provide sod.
- D. At the intersection of 156 Street and 93A Avenue:
1. in the northwest corner in the Roadway Boulevard Landscape Area, provide a minimum 9 m² of shrub/perennial beds; and
 2. in the southwest corner in the Roadway Boulevard Landscape Area, provide a minimum 9 m² of shrub/perennial beds.
- E. At the intersection of 156 Street and 95 Avenue:
1. in the northwest corner in the Roadway Boulevard Landscape Area, provide a minimum 20 m² of shrub/perennial beds; and
 2. in the southwest corner along 95 Avenue in the Roadway Boulevard Landscape Area, provide sod.
- F. At the intersection of 156 Street and 96 Avenue:
1. in the southwest corner in the Roadway Boulevard Landscape Area, provide a minimum of one (1) Street Trees and sod.
- G. At the intersection of 156 Street and 97 Avenue:
1. in the northeast corner in the Roadway Boulevard Landscape Area, provide a minimum of one (1) Street Trees in sod.

2-14.8 JASPER PLACE CHARACTER ZONE LANDSCAPE REQUIREMENTS

2-14.8.1 Jasper Place Opportunity Area

2-14.8.1.1 Location

- A. This Section 2-14.8.1 [*Jasper Place Opportunity Area*], in conjunction with the drawings in Appendix 5-2B [*Jasper Place Opportunity Area Streetscape Drawings*] of this Schedule, sets out landscape requirements for the Jasper Place Opportunity Area, which extends from 100 Avenue on 156 Street to 149 Street on Stony Plain Road.

2-14.8.1.2 Design Intent

- A. Reinststate and improve the existing streetscape in the Jasper Place Opportunity Area to the fullest extent possible.
- B. Retain and preserve the existing Street Trees in the Jasper Place Opportunity Area to the fullest extent possible.

2-14.8.1.3 Area Specific Requirements

- A. Provide Street Trees and shrub beds in accordance with the patterns, types and locations identified in Appendix 5-2B [*Jasper Place Opportunity Area Streetscape Drawings*] of this Schedule and as identified in Table 2-14.8.1.3 [*Jasper Place Opportunity Area Plant List*] of this Schedule.

Table 2-14.8.1.3: Jasper Place Opportunity Area Plant List

Scientific Name	Common Name
Canopy Trees	
Fraxinus mandshurica	Manchurian Ash
Ulmus Americana 'Brandon':	American Elm
Deciduous Ornamental Trees	
Acer tataricum ginnala	Amur Maple
Sorbus aucuparia 'Fastigiata'	Pyramidal Mountain Ash
Malus x 'Thunderchild'	Thunderchild Crabapple
Columnar Trees	
Populus tremula 'Erecta'	Swedish Columnar Aspen
Shrubs	
Berberis thunbergii 'Rose Glow'	Rose Glow Barberry
Berberis x 'Tara'	Emerald Carousel Barberry
Juniperus horizontalis 'Blue Prince'	Blue Prince Juniper
Physocarpus opulifolius 'diablo'	Diablo Ninebark
Potentilla fruticosa	White Flowering Cultivars
Spiraea x arguta 'Compacta'	Dwarf Garland Spirea
Syringa patula 'Miss Kim'	Miss Kim Lilac
Viburnum opulus 'Nanum'	Dwarf European Cranberry
Perennials	
Festuca glauca	Blue Fescue Cultivars
Hemerocallis 'Stella de Oro'	Stella de Oro Daylily
Panicum virgatum 'Shenandoah'	Shenandoah Red Switch Grass
Bergenia cordifolia 'Eden's Dark Margin'	Eden's Dark Margin Bergenia

- B. Provide Utility Complex landscaping in accordance with Appendix 5-2B [*Jasper Place Opportunity Area Streetscape Drawings*] of this Schedule.
- C. At W84, W85, W86, and W88, each as set out in Schedule 14 [*City Lands*], provide:
1. sod; and
 2. wood bumper posts along the perimeter of each lot or group of lots where two (2) or more lots are adjacent to each other.

2-14.9 GROVENOR AND GLENORA CHARACTER ZONE LANDSCAPE REQUIREMENTS

2-14.9.1 149 Street to 143 Street

2-14.9.1.1 Location

- A. This Section 2-14.9.1 [*149 Street to 143 Street*] sets out landscape requirements for the area along Stony Plain Road from 149 Street to 143 Street.

2-14.9.1.2 Design Intent

- A. Provide landscaping along Stony Plain Road that integrates with, and builds upon, the existing heritage character of the Grovenor area.
- B. Provide landscaping in Remnant Land Parcels that creates a continuous heritage aesthetic, drawing reference from classical Edwardian landscape practices.
- C. Provide landscaping near 142 Street that is contemporary and draws reference from the landscape design of Transit Oriented Developments in the area.
- D. Landscaping shall transition from heritage to contemporary in a blended, thoughtful manner.
- E. Boulevard and median plant materials shall be arranged in large flowing masses.

2-14.9.1.3 Area Specific Requirements

- A. Provide the following landscaping along Stony Plain Road from 149 Street to 146 Street:
 - 1. Canopy Trees in the Back of Walk Landscape Area along the north side of Stony Plain Road in accordance with Appendix 5-2B [*Jasper Place Opportunity Area Streetscape Drawings*] of this Schedule; and
 - 2. Naturalization in accordance with Schedule 10 [*Environmental Performance Requirements*], along the south side of Stony Plain Road to all areas in the Lands that do not receive other landscape treatments.
- B. Provide the following landscaping along Stony Plain Road from 146 Street to 144 Street:
 - 1. a single row of Street Trees and shrub beds in the Roadway Boulevard Landscape Area along the north side of Stony Plain Road; and
 - 2. a minimum of five (5) Street Trees and minimum 240 m² of shrub beds in the Back of Walk Landscape Area along the south side of Stony Plain Road.
- C. Provide the following landscaping along Stony Plain Road from 144 Street to 143 Street:
 - 1. a single row of Canopy Trees with tree grates and Soil Cells in the Roadway Boulevard Landscape Area along the north side of Stony Plain Road;
 - 2. shrub beds may be provided in lieu of tree grates in Roadway Boulevard Landscape Areas where there is sufficient hard surface area between Canopy Trees to accommodate all required bike racks, fire access, signage and other furnishings;
 - 3. Utility Complex Landscaping in accordance with Section 2-14.12 [*Utility Complex Site Landscaping*] of this Schedule at W100 and W101, as set out in Schedule 14 [*City Lands*];
 - 4. at W102 through to W108, as set out in Schedule 14 [*City Lands*]:
 - a. sod; and
 - b. wood bumper posts along the perimeter of each lot or group of lots where two (2) or more lots are adjacent to each other; and
 - 5. a single row of Street Trees with tree grates and Soil Cells in the Roadway Median Landscape Area; and

6. a minimum of four (4) Street Trees and a minimum 100 m² of shrub beds in the Roadway Boulevard Landscape Area on the south side of Stony Plain Road.

2-14.9.1.4 Intersection Specific Requirements

- A. Without limiting Section 2-14.9.1.3 [*Area Specific Requirements*] of this Schedule, this Section 2-14.9.1.4 [*Intersection Specific Requirements*] provides the landscape requirements for intersections along Stony Plain Road from 149 Street to 143 Street.
- B. At the intersection of 147 Street and Stony Plain Road:
 1. in the northeast corner in the Roadway Boulevard Landscape Area, provide a minimum of one (1) Street Tree and sod.
- C. At the intersection of 145 Street and Stony Plain Road:
 1. in the northwest corner in the Back of Walk Landscape Area, provide a minimum 20 m² of shrub/perennial beds.

2-14.9.2 142 Street Area

2-14.9.2.1 Location

- A. This Section 2-14.9.2 [*142 Street Area*] sets out landscape requirements for the areas from 143 Street to 139 Street along Stony Plain Road.

2-14.9.2.2 Design Intent

- A. To provide a high quality, contemporary urban aesthetic that uses the public realm to foster existing and future Transit Oriented Development opportunities adjacent to 142 Street on Stony Plain Road.
- B. Boulevard and median plant materials shall be arranged in geometric and structured patterns.

2-14.9.2.3 Area Specific Requirements

- A. Create a pedestrian link at 143 Street on the north side of Stony Plain Road, incorporating the following landscaping into the design of the pedestrian link:
 1. preserved existing mature elms;
 2. a minimum of four (4) trees, arranged in a linear style;
 3. a minimum of 200 m² of shrub/perennial beds, arranged in a geometric, rectilinear pattern;
 4. a minimum 80 m² of paved area, which shall:
 - a. be predominantly concrete that is:
 - i. finished with a broom, raked or sandblasted finish; and
 - ii. saw cut in geometric patterns aligning with trees, tree grates or other site elements;
 - b. include decorative pavers that shall complement the character of the Grovenor/142 Street Stop; and
 - c. not include asphalt; and
 5. sod, such that grass areas are contiguous and create useful open spaces;

- B. Provide the following landscaping along Stony Plain Road from 143 Street to 142 Street:
1. a single row of Street Trees with tree grates and Soil Cells in the Back of Walk Landscape Area along the north side of Stony Plain Road;
 2. a single row of Street Trees and shrub beds in the Roadway Median Landscape Area;
 3. a single row of Canopy Trees with tree grates and Soil Cells in the Roadway Boulevard Landscape Area along the south side of Stony Plain Road; and
 4. at W109 through to W116, each as set out in Schedule 14 [*City Lands*]:
 - a. sod; and
 - b. wood bumper posts along the perimeter of each lot or group of lots where two (2) or more lots are adjacent to each other.
- C. Provide the following landscaping along Stony Plain Road from 142 Street to 102 Avenue:
1. in the Trackway Boulevard Landscape Area:
 - a. a minimum of six (6) Canopy Trees, arranged in a curve matching the Track alignment;
 - b. a minimum of six (6) deciduous ornamental trees, arranged in a curve matching the Track alignment; and
 - c. a minimum of 700m² of shrub beds, arranged in a contemporary geometric pattern;
 - i. shrub beds shall be arranged around the Amenity Node in a manner that enhances pedestrian comfort;
 2. a single row of Canopy Trees and shrub beds in the Roadway Boulevard Landscape Area along the north side of Stony Plain Road;
 - a. boulevard plantings shall be complimentary to plantings in the Trackway Boulevard Landscape Area; and
 3. trees and a minimum of 80 m² of shrub beds in the Roadway Boulevard Landscape Area along the south side of Stony Plain Road;
 - a. trees shall be placed to fill gaps within the existing treed boulevard.
- D. Provide the following landscaping at 140 Street, north of the SUP:
1. a minimum of five (5) deciduous ornamental trees, arranged in a manner complimentary to Section 2-14.9.2.3.C.1 [*Area Specific Requirements*]; and
 2. a minimum of 120 m² of shrub beds, arranged in a contemporary geometric pattern.
- E. Provide the following landscaping along Stony Plain Road from 102 Avenue to 139 Street:
1. a single row of Canopy Trees and sod in the Roadway Boulevard Landscape Area along the southeast side of Stony Plain Road.
- F. Provide the following landscaping along 102 Avenue from Stony Plain Road to 138 Street:
1. a single row of Canopy Trees and shrubs beds in the Roadway Median Landscape Area.

2-14.9.3 Glenora Stop Area

2-14.9.3.1 Location

- A. This Section 2-14.9.3 [*Glenora Stop Area*] sets out landscape requirements for the area along 102 Avenue from 139 Street to 138 Street and along Stony Plain Road from 139 Street to Connaught Drive.

2-14.9.3.2 Design Intent

- A. Provide a landscape that respects the residential and heritage character of the Glenora area.
- B. Preserve existing trees to the fullest extent possible.
- C. Restore the existing Street Tree canopy to the fullest extent possible.
- D. Boulevard and median plant materials shall be arranged in large flowing masses, except when near the Glenora Stop where plantings shall be more traditionally arranged.

2-14.9.3.3 Area Specific Requirements

- A. Provide the following landscaping along 102 Avenue from 139 Street to 138 Street:
1. a single row of Street Trees or double row of ornamental deciduous trees and shrub beds in the Roadway Median Landscape Area; and
 2. a minimum of seven (7) trees and a minimum of 90 m² of shrub beds in the Roadway Median Landscape Area on the south side of 102 Avenue.
- B. Provide the following landscaping along Stony Plain Road from 139 Street to 136 Street:
1. a single row of Canopy Trees and shrubs beds in the Roadway Boulevard Landscape Area along the north side of Stony Plain Road;
 2. at W264, as set out in Schedule 14 [*City Lands*]:
 - a. a minimum of two (2) Canopy Trees, arranged in open grass spaces at the south of the site;
 - b. a minimum of three (3) ornamental coniferous trees, arranged at the north of the site;
 - c. a minimum of four (4) deciduous ornamental trees, located in shrub beds;
 - d. a minimum of 150 m² of shrub beds, located at the property line;
 - e. sod, such that grass areas are contiguous and create useful open spaces:
 - i. grass areas shall be arranged to create a continuous pedestrian corridor; and
 - f. Landscape Fences in accordance with Section 1-2.2.3 [*Landscape Fences*] of this Schedule along the east and west sides of the lot; and
 3. at W195, as set out in Schedule 14 [*City Lands*]:
 - a. a minimum of four (4) Canopy Trees, arranged around existing trees, and in a continuous row at the back of the walk;
 - b. a minimum of three (3) ornamental coniferous trees, located near the property lines;
 - c. a minimum of three (3) deciduous ornamental trees, located in the shrub beds;

- d. a minimum of 170 m² of shrub beds, located at the property lines and arranged around existing trees; and
 - e. sod, such that grass areas are contiguous and create useful open spaces;
 - 4. at W213, as set out in Schedule 14 [*City Lands*]:
 - a. sod; and
 - b. a minimum of 20 m² of shrub beds; and
 - 5. at W200, as set out in Schedule 14 [*City Lands*]:
 - a. a minimum of three (3) Canopy Trees, arranged in a row along the back of walk;
 - b. a minimum of three (3) ornamental coniferous trees, in shrub beds along the property line;
 - c. a minimum of four (4) deciduous ornamental trees, in shrub beds along the property line;
 - d. a minimum of 110 m² of shrub beds, located along the property lines;
 - e. sod, such that grass areas are contiguous and create useful open spaces; and
 - f. all landscape elements shall be arranged around the Amenity Node in a manner that enhances pedestrian comfort.
- C. Provide the following landscaping along Stony Plain Road from 136 Street to 135 Street:
- 1. sod in the Roadway Boulevard Landscape Area along the north side of Stony Plain Road;
 - 2. a single row of Street Trees and a shrub bed in the Roadway Boulevard Landscape Area along the south side of Stony Plain Road;
 - 3. a decorative wrought iron fence along the north property line of Glenora School conforming to Drawing #LA410 of the Valley Line West LRT Landscape Design and Construction Standards, subject to the approval of Glenora School and Alberta Infrastructure; and
 - 4. a decorative wrought iron fence adjacent to the walk at the EPCOR substation conforming to Drawing #LA410 of the Valley Line West LRT Landscape Design and Construction Standards.
- D. Provide the following landscaping along Stony Plain Road from 135 Street to 134 Street:
- 1. a single row of Street Trees and shrub beds in the Roadway Boulevard Landscape Area on the north side of Stony Plain Road;
 - 2. at W135, as set out in Schedule 14 [*City Lands*]:
 - a. a continuous row of Canopy Trees in the Back of Walk Landscape Area;
 - b. a minimum of three (3) ornamental coniferous trees, arranged in a group at the property line;
 - c. a minimum of three (3) deciduous ornamental trees, located in grass areas;
 - d. a minimum of 135 m² of shrub beds, located adjacent to the property lines; and
 - e. sod, such that grass areas are contiguous and create useful open spaces.
- E. Provide the following landscaping along Stony Plain Road from 134 Street to 133 Street:

1. a single row of Canopy Trees with tree grates and Soil Cells in the Roadway Boulevard Landscape Area on the north side of Stony Plain Road. Where trees are located directly across from a Stop they shall be set back from the non-trackside Platform edge a minimum of 6.5 m to center of trunk;
 2. shrub beds may be provided in lieu of Tree Grates in Roadway Boulevard Landscape Areas where there is sufficient hard surface area between Canopy Trees to accommodate all required bike racks, fire access, signage and other furnishings;
 3. a single row of Columnar Trees in grates in the Trackway Boulevard Landscape Area;
 4. a single row of Street Trees and shrub beds in the Roadway Boulevard Landscape Area along the south side of Stony Plain Road;
 5. at W181 as set out in Schedule 14 [*City Lands*]:
 - a. a Landscape Fence in accordance with Section 1-2.2.3 [*Landscape Fences*] of this Schedule along the north side of the lot; and
 6. at W138 as set out in Schedule 14 [*City Lands*]:
 - a. a continuous row of Canopy Trees in the Back of Walk Landscape Area;
 - b. a minimum of five (5) deciduous ornamental trees, arranged in open grass spaces;
 - c. a minimum of 65 m² of shrub beds located adjacent to the property line; and
 - d. sod, such that grass areas are contiguous and create useful open spaces.
- F. Provide the following landscaping along Stony Plain Road from 133 Street to 132 Street:
1. ornamental deciduous trees in Soil Cells with tree grates in the Trackway Boulevard Landscape Area along the north side of Stony Plain Road;
 2. a single row of Canopy Trees with tree grates and Soil Cells in the Roadway Boulevard Landscape Area along the south side of Stony Plain Road. Where trees are located directly across from a Stop they shall be set back from the non-trackside Platform edge a minimum of 6.5 m to center of trunk;
 3. shrub beds may be provided in lieu of tree grates in Roadway Boulevard Landscape Areas where there is sufficient hard surface area between Canopy Trees to accommodate all required bike racks, fire access, signage and other furnishings;
 4. at W203 as set out in Schedule 14 [*City Lands*]:
 - a. a continuous row of Canopy Trees in the Back of Walk Landscape Area;
 - b. a minimum of four (4) deciduous ornamental trees, located in shrub beds;
 - c. a minimum 4 m wide shrub bed along the north property line; and
 - d. sod, such that grass areas are contiguous and create useful open spaces.
 5. at W140 as set out in Schedule 14 [*City Lands*]:
 - a. a minimum of 100 m² of shrub beds;
 - i. shrub beds shall be arranged around the Amenity Node in a manner that enhances pedestrian comfort.

- G. Provide the following landscaping along Stony Plain Road from 132 Street to Glenora Crescent:
1. a single row of Canopy Trees and shrub beds in the Roadway Boulevard Landscape Area along the north side of Stony Plain Road;
 2. Columnar Trees in Soil Cells with tree grates in the Trackway Boulevard Landscape Area along the south side of Stony Plain Road;
 3. a single row of Canopy Trees and sod in the Roadway Boulevard Landscape Area along the south side of Stony Plain Road; and
 4. Utility Complex landscaping in accordance with Section 2-14.12 [*Utility Complex Site Landscaping*] of this Schedule at W302 and W142 as set out in Schedule 14 [*City Lands*].
- H. Provide the following landscaping along Stony Plain Road from Glenora Crescent to Connaught Drive:
1. a single row of Street Trees and shrub beds in the Roadway Boulevard Landscape Area along the north side of Stony Plain Road.

2-14.9.3.4 Intersection Specific Requirements

- A. Without limiting Section 2-14.9.3.3 [*Area Specific Requirements*] of this Schedule, this Section 2-14.9.3.4 [*Intersection Specific Requirements*] provides the landscape requirements for intersections along Stony Plain Road.
- B. At the intersection of 136 Street and Stony Plain Road:
1. in the southwest corner at the Back of Walk Landscape Area, provide a minimum 30 m² of shrub/perennial beds.

2-14.9.3.5 Park Parcel Specific Requirements

- A. At W137, extending up to W181, each as set out in Schedule 14 [*City Lands*], not including any planting in the Roadway Boulevard Landscape Area adjacent to these properties:
1. the landscape shall incorporate traditional design references borrowed from Alexander Circle Park;
 2. provide a minimum of twenty (20) deciduous ornamental trees in Soil Cells with tree grates:
 - a. tree grates may be omitted where trees are planted in shrub beds;
 3. provide a minimum of 120 m² to a maximum of 200 m² of shrub beds, where:
 - a. roses shall comprise a minimum of 30% of the total quantity of shrubs;
 4. provide a minimum of 680 m² of contiguous paved area, where paving shall:
 - a. be predominantly concrete and:
 - i. provide multiple routes of pedestrian travel;
 - ii. provide dedicated locations for seating;
 - iii. provide locations for mounting bicycle racks;
 - iv. be finished with a broom, raked or sandblasted finish; and

- v. be saw cut in geometric patterns aligning with trees or tree grates; and
 - b. include decorative bands of brick paving, where:
 - i. pavers shall be complimentary to the heritage character of Glenora; and
- 5. provide the following public amenities:
 - a. six (6) benches substantially similar to those provided at the Glenora Stop;
 - b. two (2) waste receptacles substantially similar to those provided at the Glenora Stop; and
 - c. decorative pedestrian lighting including:
 - i. a minimum of six (6) illuminated bollards; and
 - ii. sufficient decorative pedestrian lighting to meet the required illumination levels.

B. At Samuel Dickson Rotary Park provide:

- 1. landscaping which incorporates traditional design references borrowed from Alexander Circle Park;
- 2. site furnishings matching those that exist in the park, excluding the existing monument, and install furnishings in locations appropriate to their use, and in general alignment with their original function;
- 3. concrete walks that connect logically to existing pedestrian routes;
- 4. a minimum of 250 m² of shrub beds, where:
 - a. a minimum of 130 m² of shrub beds shall be dedicated to roses and flowering perennials;
- 5. a minimum of 400 m² of contiguous sodded open space;
- 6. a minimum of 100 m² of contiguous concrete paved open space, where paving shall:
 - a. be predominantly concrete and:
 - i. provide multiple routes of pedestrian travel;
 - ii. provide dedicated locations for seating;
 - iii. be finished with a broom, raked or sandblasted finish; and
 - iv. be saw cut in geometric patterns; and
 - b. include decorative bands of brick paving, where:
 - i. pavers shall be complimentary to the heritage character of Glenora;
- 7. the following trees:
 - a. a minimum of nine (9) ornamental coniferous trees;
 - b. a minimum of nine (9) Canopy Trees; and
 - c. a minimum of seventeen (17) deciduous ornamental trees; and
- 8. the following public amenities:

- a. two (2) benches substantially similar to those that are currently provided in Samuel Dickson Rotary Park, in addition to the one (1) to be provided at the Amenity Node;
- b. one (1) waste receptacle substantially similar to those that are currently provided in Samuel Dickson Rotary Park, in addition to the one (1) to be provided at the Amenity Node; and
- c. decorative pedestrian lighting, including:
 - i. a minimum of five (5) illuminated bollards; and
 - ii. sufficient decorative pedestrian lighting to meet the required illumination levels.

C. At the Stony Plain Road Bridge:

- 1. provide Naturalization in accordance with Schedule 10 [*Environmental Performance Requirements*] to all areas in the Lands that do not receive other landscape treatments;
- 2. provide a Wildlife Crossing Bench for each bridge abutment in accordance with the functional requirements of Section 22.3 [*Permanent Accommodation of Wildlife Movement*] of Schedule 10 [*Environmental Performance Requirements*], the structural requirements in Section 4-3.2.14 [*Wildlife Crossing*] of this Schedule, and the following:
 - a. along each Wildlife Crossing Bench, provide a mix of boulders and logs, placed randomly and positioned within a maximum of 100 mm from the edge of the downslope abutment. Boulder/log mix shall be approximately 60% boulders and 40% logs:
 - i. place boulders such that the minimum spacing between boulders is 0.3 m and the maximum spacing between boulders is 2.0 m. Boulder spacing shall be measured from the outside face of each boulder at ground level;
 - ii. boulders shall be a minimum of 0.3 m tall and a maximum of 0.6 m tall. Boulder height shall be measured from the top of the compacted clay to the top of the boulder;
 - iii. boulders shall be securely embedded in the compacted clay and shall be immovable through normal means;
 - iv. logs shall be placed in locations that provide shelter for small animals;
 - v. logs shall be securely mounted and shall be immovable by normal means;
 - vi. logs shall be sourced from local hardwoods and have a minimum dimension of 250 mm. All cut edges shall be clean, bark shall be peeled, and jagged edges minimized; and
 - vii. logs shall be placed parallel to the path of wildlife travel and shall be located in a manner that minimizes trip hazards; and
 - b. naturally occurring and Naturalization plant materials at the periphery of the Wildlife Crossing Bench crossing shall be encouraged to encroach into the Wildlife Crossing Bench.
- 3. if concrete slope protection is not required for the headslopes of the Stony Plain Road Bridge, provide:
 - a. naturally occurring and Naturalization plant materials encroaching into the edges of the headslope areas;
 - b. boulders, which shall be:

- i. securely embedded in compacted clay such that they are immovable through normal means; and
- ii. a minimum of 0.3 m tall and a maximum of 0.6 m tall, measured from the top of the compacted clay to the top of the boulder; and
- c. a minimum of 150 mm of rock material of the same rock composition as the boulders, which shall be restricted from moving through the use of geotextile material as needed.

2-14.9.4 Stony Plain Road Bridge to 126 Street Area

2-14.9.4.1 Location

- A. This Section 2-14.9.4 [*Stony Plain Road Bridge to 126 Street Area*] sets out landscape requirements for the area along Stony Plain Road from the Stony Plain Road Bridge to 125 Street.

2-14.9.4.2 Design Intent

- A. To provide a landscape that respects the residential and heritage character of the Westmount area.
- B. To preserve existing trees to the fullest extent possible.
- C. To restore the existing street tree canopy to the fullest extent possible.
- D. Boulevard and median plant materials shall be arranged in large flowing masses.

2-14.9.4.3 Area Specific Requirements

- A. Provide the following landscaping along Stony Plain Road from the Stony Plain Road Bridge to Woodbend Place:
 - 1. a single row of Street Trees and shrub beds in the Roadway Boulevard Landscape Area along the north side of Roadway;
 - 2. a single row of Street Trees and shrub beds in the Roadway Boulevard Landscape Area along the south side of Roadway;
 - 3. Naturalization in accordance with Schedule 10 [*Environmental Performance Requirements*] at portions of W145, W146, W146A, W146B, and W146C, as set out in Schedule 14 [*City Lands*], that are not receiving other landscape treatments; and
 - 4. at W146D as set out in Schedule 14 [*City Lands*]:
 - a. a continuous row of Canopy Trees in the Back of Walk Landscape Area;
 - b. sod; and
 - c. a minimum 4 m wide shrub bed along the south side of the lot.
- B. Provide the following landscaping along Stony Plain Road from Woodbend Place to 126 Street:
 - 1. a single row of Canopy Trees and shrub beds in the Roadway Boulevard Landscape Area along the north side of Roadway;
 - 2. a single row of Canopy Trees and shrub beds in the Roadway Boulevard Landscape Area along the south side of Roadway;

3. a single row of trees and a minimum of 260 m² of shrub beds in the Back of Walk Landscape Area along the south side of Roadway;
 4. at W205 and W147A as set out in Schedule 14 [*City Lands*]:
 - a. a continuous row of Canopy Trees in the Roadway Boulevard Landscape Area and in the Back of Walk Landscape Area:
 - i. trees shall be planted in the grass areas on each side of the SUP, in a staggered manner and shall follow the curve of the SUP;
 - b. a minimum of 150 m² of shrub beds, located in the Back of Walk Landscape Area;
 - c. a minimum of 60 m² of shrub beds located adjacent to the south property line; and
 - d. sod, such that grass areas are contiguous and create useful open spaces.
 5. at W282 and W148 as set out in Schedule 14 [*City Lands*]:
 - a. a continuous row of Canopy Trees in the Roadway Boulevard Landscape Area and the Back of Walk Landscape Area;
 - i. trees shall be planted in the grass areas on each side of the SUP, in a staggered manner and shall follow the curve of the SUP;
 - b. a minimum of 140 m² of shrub beds, located at the south side of the lots; and
 - c. sod, such that grass areas are contiguous and create useful open spaces.
 6. at W149, as set out in Schedule 14 [*City Lands*]:
 - a. sod; and
 - b. wood bumper posts around the perimeter of each lot or group of lots where two (2) or more lots are adjacent to each other.
- C. Provide the following landscaping along Stony Plain Road from 126 Street to 125 Street:
1. a single row of Street Trees with sod in the Roadway Boulevard Landscape Area along the north side of Roadway.

2-14.9.4.4 Intersection Specific Requirements

- A. Without limiting Section 2-14.9.4.3 [*Area Specific Requirements*] of this Schedule, this Section 2-14.9.4.4 [*Intersection Specific Requirements*] provides the landscape requirements for intersections along Stony Plain Road from the Stony Plain Road Bridge to 125 Street.
- B. At the intersection of 127 Street and Stony Plain Road in the northeast corner of the Back of Walk Landscape Area, provide a minimum of three (3) trees and a minimum 130 m² shrub/perennial bed; Landscaping shall be complimentary to adjacent existing landscape.
- C. At the intersection of 126 Street and Stony Plain Road in the northwest corner of the Roadway Boulevard Landscape Area, provide a minimum of two (2) Canopy Trees in tree grates with Soil Cells.

2-14.9.4.5 Park Parcel Specific Requirements

- A. At W295, as set out in Schedule 14 [*City Lands*], provide sod.

2-14.9.5 124 Street Area

2-14.9.5.1 Location

- A. This Section 2-14.9.5 [*124 Street Area*] sets out landscape requirements for the area along Stony Plain Road from 125 Street to 121 Street.

2-14.9.5.2 Design Intent

- A. Provide a high-quality urban aesthetic that references and improves the existing 124 Street pedestrian realm.
- B. Boulevard and median plant materials shall be arranged in large flowing masses, except when near 124 Street where plantings shall be more geometric and structured.

2-14.9.5.3 Area Specific Requirements

- A. Provide the following landscaping along Stony Plain Road from 125 Street to 121 Street:
1. a single row of Canopy Trees with tree grates and Soil Cells in the Roadway Boulevard Landscape Area along the north side of Stony Plain Road;
 2. a single row of Canopy Trees with tree grates and Soil Cells in the Trackway Boulevard Landscape Area along the north side of Stony Plain Road;
 3. a single row of Street Trees with tree grates and Soil Cells in the Roadway Boulevard Landscape Area along the south side of Stony Plain Road;
 4. shrub beds may be provided in lieu of tree grates in Roadway Boulevard Landscape Area where there is sufficient hard surface area between Street Trees to accommodate all required bike racks, fire access, signage and other furnishings;
 5. Utility Complex landscaping in accordance with Section 2-14.12 [*Utility Complex Site Landscaping*] of this Schedule;
 6. at W156, as set out in Schedule 14 [*City Lands*]:
 - a. sod;
 7. at W157, as set out in Schedule 14 [*City Lands*]:
 - a. sod; and
 - b. wood bumper posts around the perimeter of each lot or group of lots where two (2) or more lots are adjacent to each other;
 8. at W158, as set out in Schedule 14 [*City Lands*]:
 - a. a minimum of two (2) ornamental deciduous trees;
 - b. a minimum 60 m² shrub bed, located along the property line; and
 - c. sod.
 9. at W159, as set out in Schedule 14 [*City Lands*]:
 - a. sod; and

10. at W160, as set out in Schedule 14 [*City Lands*]:
 - a. a minimum of three (3) Canopy Trees, planted in a row at the back of walk;
 - b. a minimum of two (2) ornamental deciduous trees;
 - c. a minimum 90m² shrub bed, located along the property line;
 - i. the shrub bed shall stop in alignment with the block face; and
 - d. sod.

2-14.9.5.4 Intersection Specific Requirements

- A. Without limiting Section 2-14.9.5.3 [*Area Specific Requirements*] of this Schedule, this Section 2-14.9.5.4 [*Intersection Specific Requirements*] provides the landscape requirements for intersections along Stony Plain Road from 125 Street to 121 Street.
- B. At the intersection of 124 Street and Stony Plain Road:
 1. in the northwest corner in the Roadway Boulevard Landscape Area, provide a single row of Street Trees and shrub beds; and
 2. in the northeast corner in the Roadway Boulevard Landscape Area, provide a single row of Street Trees with tree grates and Soil Cells.

2-14.10 DOWNTOWN CHARACTER ZONE LANDSCAPE REQUIREMENTS

2-14.10.1 104 Avenue

2-14.10.1.1 Location

- A. This Section 2-14.10.1 [*104 Avenue*] sets out landscape requirements for the area on 104 Avenue from 121 Street to 105 Street.
- B. Boulevard and median plant materials shall be arranged in contemporary, geometric masses.

2-14.10.1.2 Design Intent

- A. Provide landscaping that presents a contemporary aesthetic complementing nearby developments.

2-14.10.1.3 Area Specific Requirements

- A. Provide the following landscaping along 104 Avenue between 121 Street and 119 Street:
 1. a single row of Street Trees with tree grates and Soil Cells in the Roadway Boulevard Landscape Area along the north side of Roadway;
 2. a minimum of thirty-five (35) Columnar Trees and shrub beds in the Trackway Boulevard Landscape Area along the north side of the Trackway;
 3. a minimum of twenty (20) Columnar Trees and shrub beds in the Trackway Boulevard Landscape Area along the south side of the Trackway;
 4. a single row of Street Trees with shrub beds in the Roadway Boulevard Landscape Area along the south side of Roadway; and

5. shrub beds may be provided in lieu of tree grates in Roadway Boulevard Landscape Areas where there is sufficient hard surface area between Street Trees to accommodate all required bike racks, fire access, signage and other furnishings.
- B. Provide the following landscaping along 104 Avenue between 119 Street and 118 Street:
1. a single row of Street Trees with tree grates and Soil Cells in the Roadway Boulevard Landscape Area along the north side of Roadway;
 2. a minimum of forty (40) Columnar Trees and shrub beds in the Trackway Boulevard Landscape Area;
 3. a single row of Street Trees with tree grates and Soil Cells in the Roadway Boulevard Landscape Area along the south side of Roadway;
 4. shrub beds may be provided in lieu of tree grates in Roadway Boulevard Landscape Areas where there is sufficient hard surface area between Street Trees to accommodate all required bike racks, fire access, signage and other furnishings; and
 5. Utility Complex landscaping in accordance with Section 2-14.12 [*Utility Complex Site Landscaping*] of this Schedule.
- C. Provide the following landscaping along 104 Avenue between 118 Street and 117 Street:
1. a minimum of thirty (30) Columnar Trees and shrub beds in the Trackway Boulevard Landscape Area.
- D. Provide the following landscaping along 104 Avenue between 117 Street and 116 Street:
1. a single row of Street Trees with tree grates and Soil Cells in the Roadway Boulevard Landscape Area along the south side of Roadway; and
 2. shrub beds may be provided in lieu of tree grates in Roadway Boulevard Landscape Areas where there is sufficient hard surface area between Street Trees to accommodate all required bike racks, fire access, signage and other furnishings.
- E. Provide the following landscaping along 104 Avenue between 116 Street and 114 Street:
1. a minimum of twenty (20) Columnar Trees and shrub beds in the Trackway Boulevard Landscape Area.
- F. Provide the following landscaping along 104 Avenue between 114 Street and 112 Street:
1. a minimum of thirty (30) Columnar Trees and shrub beds in the Trackway Boulevard Landscape Area.
- G. Provide the following landscaping along 104 Avenue between 112 Street and 107 Street:
1. a single row of Street Trees with shrub beds in the Roadway Boulevard Landscape Area along the north side of Roadway; and
 2. a minimum of thirty-five (35) Columnar Trees and shrub beds in the Trackway Boulevard Landscape Area.
- H. Provide the following landscaping along 104 Avenue between 107 Street and 105 Street:
1. a single row of Street Trees with shrub beds in the Roadway Boulevard Landscape Area along the north side of Roadway; and

2. three (3) staggered rows of ornamental deciduous trees and a minimum of 350 m² of shrub beds in the Roadway Median Landscape Area.

2-14.10.1.4 Intersection Specific Requirements

- A. Without limiting Section 2-14.10.1.3 [*Area Specific Requirements*] of this Schedule, this Section 2-14.10.1.4 [*Intersection Specific Requirements*] provides the landscape requirements for intersections along 104 Avenue from 121 Street to 105 Street.
- B. At the intersection of 120 Street and 104 Avenue:
 1. in the northwest corner, provide Street Trees with tree grates and Soil Cells in the Roadway Boulevard Landscape Area; and
 2. in the southwest corner, provide Street Trees with shrub beds in the Roadway Boulevard Landscape Area.
- C. At the intersection of 119 Street and 104 Avenue:
 1. in the southeast corner, provide Street Trees with tree grates and Soil Cells in the Roadway Boulevard Landscape Area.
- D. At the intersection of 116 Street and 104 Avenue:
 1. in the northeast corner, provide a minimum of five (5) Canopy Trees in the Back of Walk Landscape Area.

2-14.10.1.5 Park Parcel Specific Requirements

- A. At Oliver Park:
 1. provide sod in the Back of Walk Landscape Area.

2-14.10.2 107 Street

2-14.10.2.1 Location

- A. This Section 2-14.10.2 [*107 Street*], in conjunction with the drawings in Appendix 5-2A [*102 Avenue – 107 Street Streetscape Drawings*] of this Schedule, sets out landscape requirements for the area on 107 Street from 104 Avenue to 102 Avenue.

2-14.10.2.2 Design Intent

- A. To establish new Street Trees in the streetscape.

2-14.10.2.3 Area Specific Requirements

- A. Provide Street Trees in Soil Cells with tree grates in the Roadway Boulevard Landscape Area on the east side of 107 Street, which shall be placed as close as possible to the edge of the sidewalk adjacent to the Roadway to maximize the clear width of sidewalk for pedestrians.
 1. Where the Street Trees in the Roadway Boulevard Landscape Area on the east side of 107 Street align in cross-section with the NorQuest Stop, they shall be set back a minimum of 6.5 m from the trackside Platform edge, measured to the centre of the tree trunk.
- B. Provide Utility Complex landscaping in accordance with Section 2-14.12 [*Utility Complex Landscaping*] of this Schedule.

- C. At W219, as set out in Schedule 14 [*City Lands*], provide:
1. sod; and
 2. wood bumper posts around the perimeter of the lot or group of lots where two (2) or more lots are adjacent to each other.
- D. Provide Street Trees and shrub beds in accordance with the patterns, types and locations identified in Appendix 5-2A [*102 Avenue – 107 Street Streetscape Drawings*] of this Schedule and as identified in Table 2-14.10.2.3 [*107 Street Streetscape Plant List*] of this Schedule.

Table 2-14.10.2.3: 107 Street Streetscape Plant List

Scientific Name	Common Name
Canopy Trees	
<i>Fraxinus pensylvanica</i>	'Prairie Spire' or 'Patmore'
<i>Ulmus americana</i> & cultivars	American Elm, Brandon Elm
Shrubs	
<i>Berberis thunbergii</i>	Rosy Glow Barberry
<i>Berberis x 'Tara'</i>	Emerald Carousel Barberry
<i>Juniperus horizontalis</i>	Horizontal juniper cultivars
<i>Symphoricarpos sp</i>	Snowberry
<i>Spiraea x arguta 'Compacta'</i>	Dwarf Garland Spirea
<i>Viburnum opulus 'nana'</i>	Compact Cranberries
<i>Physocarpus opulifolius 'Tiny Wine', 'Little Devil' or approved equal</i>	Dwarf Ninebark cultivars
Perennials	
<i>Hemerocallis sp.</i>	Daylily
<i>Rudbeckia fulida 'Goldsturm'</i>	Goldstrum Black-Eyed Susan
<i>Sedum spectabile 'Abbeydore', 'Autumn Fire' or approved equal</i>	Autumn/Showy Sedum
Perennial Ornamental Grasses	
<i>Calamagrostis x acutiflora</i>	Feather Reed Grass Cultivars
<i>Festuca glauca</i>	Blue Fescue Cultivars
<i>Helictotricon sempervirens</i>	Blue Oat Grass
<i>Deschampsia cespitosa</i>	Tufted Hairgrass cultivars

2-14.10.3 Alex Decoteau Park

2-14.10.3.1 Location

- A. This Section 2-14.10.3 [*Alex Decoteau Park*], in conjunction with the drawings in Appendix 5-2A [*102 Avenue – 107 Street Streetscape Drawings*] of this Schedule, sets out landscape requirements for the area on the north side of 102 Avenue from the lane west of Alex Decoteau Park to 105 Street.

2-14.10.3.2 Design Intent

- A. To integrate the Alex Decoteau Stop and the 102 Avenue streetscape with the existing Alex Decoteau Park.

2-14.10.3.3 Area Specific Requirements

- A. Provide Street Trees and shrub beds in accordance with the patterns, types and locations identified in Appendix 5-2A [102 Avenue – 107 Street Streetscape Drawings] of this Schedule and as identified in Table 2-14.10.3.3 [Alex Decoteau Plant List] of this Schedule.

Table 2-14.10.3.3: Alex Decoteau Park Plant List

Scientific Name	Common Name
Canopy Trees	
<i>Acer saccharinum</i>	Silver Maple
<i>Gleditsia tricanthos var inermis</i>	'Dursan', 'Shademaster' or 'Northern Acclaim' Honeylocust
<i>Ulmus Americana:</i>	American Elm
<i>Quercus borealis</i>	Northern Red Oak
<i>Quercus macrocarpa</i>	Bur Oak
Shrubs	
<i>Cornus alba</i>	'Kesselring' Dogwood
<i>Cronus alba</i>	'Gouchaultii'
<i>Spirea x bumalda</i>	'Goldflame'
Perennials	
<i>Rudbeckia fulgida 'Goldsturm'</i>	Goldstrum Black-Eyed Susan
<i>Hemerocallis sp.</i>	Daylily
<i>Sedum spectabile 'Abbeydore', 'Autumn Fire' or approved equal</i>	Autumn/Showy Sedum
Perennial Ornamental Grasses	
<i>Calamagrostis x acutiflora</i>	Feather Reed Grass Cultivars
<i>Festuca glauca</i>	Blue Fescue Cultivars
<i>Helictotricon sempervirens</i>	Blue Oat Grass

- B. Return all existing irrigation systems to their original function.
- C. Re-install or reconstruct all furnishings that are moved during construction.
- D. Provide a minimum 600 mm wide Platform extension to the north Platform of the Alex Decoteau Stop adjacent to all areas where grass will be provided along the existing Alex Decoteau Park.
- E. Provide concrete pathways leading into Alex Decoteau Park from the north Platform of the Alex Decoteau Stop in accordance with Appendix 5-2A [102 Avenue – 107 Street Streetscape Drawings] of this Schedule. New and reconstructed concrete pathways leading in to the park shall:
1. be tied to existing concrete at locations that naturally align with existing saw cut, tool line or pattern geometry;
 2. have no slopes greater than 6%;
 3. have no slopes less than 2%;
 4. be patterned to match existing; and
 5. have no steps with greater than 150 mm rise, or less than 350 mm run.

- F. Grass areas connecting the Alex Decoteau Stop to the Alex Decoteau Park shall not have slopes steeper than 6% or flatter than 2%.
- G. Tree spacing within Alex Decoteau Park shall be as shown in Appendix 5-2A [102 Avenue – 107 Street Streetscape Drawings] of this Schedule, which corresponds to the spacing between the existing trees within the park.

2-14.10.4 102 Avenue

2-14.10.4.1 Location

- A. This Section 2-14.10.4 [102 Avenue], in conjunction with the drawings in Appendix 5-2A [102 Avenue – 107 Street Streetscape Drawings] of this Schedule, sets out landscape requirements for the area of 102 Avenue from 107 Street to 102 Street.

2-14.10.4.2 Design Intent

- A. The landscaping shall be simple and contemporary to reflect the urban character of the Downtown Character Zone and shall be used to highlight the Stops.

2-14.10.4.3 Area Specific Requirements

- A. Colourful mass-planted shrub and/or perennial beds shall be used to highlight the PPZ and all Stops along 102 Avenue.
- B. Provide Street Trees and shrub beds in accordance with the patterns, types and locations identified in Appendix 5-2A [102 Avenue – 107 Street Streetscape Drawings] of this Schedule and as identified in Table 2-14.10.4.3 [102 Avenue Streetscape Plant List] of this Schedule.

Table 2-14.10.4.3: 102 Avenue Streetscape Plant List

Scientific Name	Common Name
Canopy Trees	
<i>Ulmus Americana:</i>	American Elm
Shrubs	
<i>Juniperus horizontalis</i>	Horizontal juniper cultivars
<i>Symphoricarpos sp</i>	Snowberry
<i>Viburnum opulus 'nana'</i>	Compact Cranberries
<i>Physocarpus opulifolius 'Tiny Wine', 'Little Devil' or approved equal</i>	Dwarf Ninebark cultivars
Perennials	
<i>Rudbeckia fulgida 'Goldstrum'</i>	Goldstrum Black-Eyed Susan
<i>Hemerocallis sp.</i>	Daylily
<i>Sedum spectabile 'Abbeydore', 'Autumn Fire' or approved equal</i>	Autumn/Showy Sedum
Perennial Ornamental Grasses	
<i>Calamagrostis x acutiflora</i>	Feather Reed Grass Cultivars
<i>Festuca glauca</i>	Blue Fescue Cultivars
<i>Helictotricon sempervirens</i>	Blue Oat Grass
<i>Deschampsia cespitosa</i>	Tufted Hairgrass cultivars

2-14.11 GERRY WRIGHT OMF PARCEL B LANDSCAPING

2-14.11.1 Location

- A. This Section 2-14.11 [*Gerry Wright OMF Parcel B Landscaping*] sets out landscape requirements for Gerry Wright OMF Parcel B.

2-14.11.1 Design Intent

- A. The landscaping shall consist of a low maintenance landscape and shall screen the views of the Gerry Wright OMF Stage 2 working and storage areas from 51 Avenue.
- B. All landscaping on the Gerry Wright OMF Building B site shall be designed to support the LEED® certification of the Gerry Wright OMF Building B.
- C. Landscaping shall create useful outdoor spaces for users of the Gerry Wright OMF Building B.

2-14.11.2 Area Specific Requirements

- A. The existing perimeter landscaping along Whitemud Drive south of Gerry Wright OMF Parcel A and B shall be protected and:
 - 1. if Infrastructure is required to be constructed on Gerry Wright OMF Parcel C in accordance with Section 8-2.7 [*Gerry Wright OMF Part C Yard*] of this Schedule, perimeter landscaping similar to the existing perimeter landscaping south of Gerry Wright OMF Parcel A and B shall be provided south of Gerry Wright OMF Parcel C along Whitemud Drive.
- B. Provide Landscaped Areas within Gerry Wright OMF Parcel B, as follows:
 - 1. trees in shrub beds:
 - a. at the north portion of the Gerry Wright OMF Building B site:
 - i. provide a minimum of fourteen (14) Street Trees;
 - ii. provide a minimum of ten (10) coniferous trees; and
 - 2. sod for the remainder of the site, such that grass areas are contiguous and create useful open spaces.
- C. Parking lot islands within the Gerry Wright OMF Parcel B Site shall be provided with a minimum of one (1) Canopy Tree and shrub beds.
- D. Parking lot end caps within the Gerry Wright OMF Parcel B Site shall be provided with a minimum of two (2) Canopy Trees and shrub beds.

2-14.12 UTILITY COMPLEX SITE LANDSCAPING

2-14.12.1 Location

- A. This Section 2-14.12 [*Utility Complex Site Landscaping*] sets out landscape requirements for each Utility Complex Site.

2-14.12.2 Design Intent

- A. The landscape shall visually integrate the Utility Complex into the adjacent neighbourhood character by screening, to the fullest extents possible, the Utility Complex and associated utilities and parking areas from adjacent land uses.

- B. The landscape design aesthetic and materials shall correspond to the Character Zone in which it is situated in accordance with the requirements provided in Section 2-14.6 [*West Edmonton Character Zone Landscape Requirement*] through Section 2-14.10 [*Downtown Character Zones Landscape Requirement*] of this Schedule.
- C. Landscaping surrounding Utility Complexes shall screen, at a minimum, the following percentage of each Utility Complex wall, not including openings or Public Art, at plant maturity:
 - 1. walls adjacent to residential properties: 90%;
 - 2. walls adjacent to Roadways or alleys: 75%;
 - 3. walls adjacent to commercial or industrial properties: 50%; and
 - 4. walls adjacent to parkland or a natural area: 75%.

2-14.12.3 Landscape Screening Requirements

- A. Landscaping shall be distributed around the Utility Complexes, but need not be provided where openings, such as doors and louvres, or Public Art would be blocked.
- B. Plant materials for Utility Complex landscaping shall be complementary to plant materials within the applicable Character Zone or PPZ.
- C. The landscaping shall accommodate Utility Complex operations, Maintenance and access in accordance with Appendix 5-1D [*Operability and Maintainability Parameters*] of this Schedule.
- D. Provide Landscape Fences in accordance with Section 1-2.2.3 [*Landscape Fences*] of this Schedule on Utility Complex sites where required by Section 2-14.6 [*West Edmonton Character Zone Landscape Requirement*] through Section 2-14.10 [*Downtown Character Zones Landscape Requirement*] of this Schedule and as shown on Figures 5-1A-01 to 5-1A-44 of Appendix 5-1A [*Project Description Drawings*] of this Schedule.

2-14.12.4 Location-Specific Requirements

- A. Provide landscaping at each Utility Complex site in accordance with requirements for each quadrant of the site in accordance with Table 2-14.12.4 [*Utility Complex Landscaping Requirements*].

Table 2-14.12.4: Utility Complex Landscaping Requirements

Utility Complex	Minimum requirement (by quadrant)				Other Requirements
	NW	NE	SE	SW	
87 Avenue and 190 Street	n/a	A continuous row of columnar trees along the east side of the Utility Complex	50 m ² of shrub beds, a continuous row of columnar trees along the east side of the Utility Complex and at least one (1) ornamental deciduous tree	30 m ² of shrub beds	Provide grass over the remainder of the site. Trees are not required where the minimum functional width of a landscape bed is 1.2 m or less. In these areas, provide perennial vines complete with permanent supportive structures along the Utility Complex perimeter walls.
87 Avenue and 182 Street	100 m ² of shrub beds, at least one (1) ornamental deciduous tree and at least two (2) ornamental coniferous trees	150 m ² of shrub beds, a continuous row of columnar trees along the north side of the Utility Complex and at least two (2) ornamental coniferous trees	170 m ² of shrub beds and at least seven (7) ornamental coniferous trees	40 m ² of shrub beds and a continuous row of columnar trees along the west side of the Utility Complex	Provide grass over the remainder of the site.
87 Avenue and 165 Street	As identified in Appendix 5-2C [<i>Under Guideway Landscape Area Drawings</i>] of this Schedule				
89 Avenue and Meadowlark Road	10 m ² of shrub beds and a continuous row of columnar trees along the north side of the Utility Complex	20 m ² of shrub beds, a continuous row of columnar trees along the north side of the Utility Complex, at least one (1) ornamental coniferous tree	180 m ² of shrub beds, a continuous row of columnar trees along the south side of the Utility Complex, at least three (3) ornamental deciduous trees and at least three (3) ornamental coniferous trees	10 m ² of shrub beds and a continuous row of columnar trees along the south side of the Utility Complex	Provide grass over the remainder of the site. Trees are not required where the minimum functional width of a landscape bed is 1.2 m or less. In these areas, provide perennial vines complete with permanent supportive structures along the Utility Complex perimeter walls.

Utility Complex	Minimum requirement (by quadrant)				Other Requirements
	NW	NE	SE	SW	
156 Street and 94 Avenue	190 m ² of shrub beds, a continuous row of columnar trees along the north side of the Utility Complex, at least two (2) ornamental coniferous trees and at least one (1) ornamental deciduous tree	130 m ² of shrub beds, a continuous row of columnar trees along the north side of the Utility Complex and at least three (3) ornamental deciduous trees	80 m ² of shrub beds, a continuous row of columnar trees along the south side of the Utility Complex and at least three (3) ornamental deciduous trees	110 m ² of shrub beds, a continuous row of columnar trees along the south side of the Utility Complex, at least one (1) ornamental deciduous tree and at least two (2) ornamental coniferous trees	Provide grass over the remainder of the site.
100A Avenue and 156 Street	As identified in Appendix 5-2B [<i>Jasper Place Opportunity Area Streetscape Drawings</i>] of this Schedule				
Stony Plain Road and 144 Street	50 m ² of shrub beds and a continuous row of columnar trees along the west and north sides of the Utility Complex	25 m ² of shrub beds and a continuous row of columnar trees along the east side of the Utility Complex	50 m ² of shrub beds, a continuous row of columnar trees along the east side of the Utility Complex, at least one (1) ornamental deciduous tree and at least two (2) ornamental coniferous trees	90 m ² of shrub beds a continuous row of columnar trees along the west side of the Utility Complex, at least one (1) ornamental deciduous tree and at least two (2) ornamental coniferous trees	Provide grass over the remainder of the site.
Stony Plain Road and 132 Street	60 m ² of shrub beds, a continuous row of columnar trees along the north side of the Utility Complex, at least two (2) ornamental deciduous trees and at least one (1) ornamental coniferous tree	40 m ² of shrub beds, a continuous row of columnar trees along the north side of the Utility Complex	90 m ² of shrub beds, at least one (1) ornamental deciduous tree and at least one (1) ornamental coniferous tree	230 m ² of shrub beds, at least five (5) ornamental deciduous trees and at least one (1) ornamental coniferous trees	Provide grass over the remainder of the site.
125 Street and 105 Avenue	38 m ² of shrub beds, and a continuous row of columnar trees	40 m ² of shrub beds, and a continuous row of columnar trees	48 m ² of shrub beds, a continuous row of columnar trees along the east side of the Utility Complex, at least one (1) ornamental deciduous tree and at least one (1) ornamental coniferous trees	34 m ² of shrub beds, and a continuous row of columnar trees	Provide grass over the remainder of the site.

Utility Complex	Minimum requirement (by quadrant)				Other Requirements
	NW	NE	SE	SW	
Oliver Square	60 m ² of shrub beds, and a continuous row of columnar trees	32 m ² of shrub beds, and a continuous row of columnar trees	32 m ² of shrub beds, and a continuous row of columnar trees	60 m ² of shrub beds, and a continuous row of columnar trees	Provide grass over the remainder of the site.
107 Street and 104 Avenue	As identified in Appendix 5-2A [102 Avenue – 107 Street Streetscape Drawings] of this Schedule				

- B. Shrub beds and trees required by Table 2-14.12.4 [Utility Complex Landscaping Requirements] of this Schedule may be re-distributed between planting quadrants at the same Utility Complex site as required to adhere to Section 2-14.12.3A [Landscape Screening Requirements] of this Schedule.

2-14.13 EXISTING STORMWATER MANAGEMENT FACILITIES LANDSCAPE REQUIREMENTS

- A. Parts of existing Storm Water Management Facilities within the Lands shall be landscaped to best match existing surrounding landscapes.

2-14.14 ISOLATED LANDSCAPE DISTURBANCE

- A. Areas of isolated landscape disturbance that are not otherwise identified in the Agreement shall be restored to conditions present at the time of the start of Construction of the applicable Work Package, and subject to the following:

1. restore all existing landscaped areas in accordance with the Valley Line West LRT Landscape Design and Construction Standards.

2-14.15 TREE RETENTION, REMOVAL, AND PROTECTION

- A. This Section 2-14.15 [Tree Retention, Removal, and Protection] sets out the tree retention, removal, and protection (TRRP) requirements for the Project.

- B. Within 180 days of the Effective Date, submit to the City a plan (the “TRRP Plan”) that:

1. incorporates the Tree Valuation Inventory tables included in the Proposal Extracts and includes the following information for all existing trees within the Lands:

a. Table 1:

- i. Tree Identification Number;
- ii. tree species;
- iii. Dbh - caliper diameter at breast height;
- iv. assessment value;
- v. Preservation Trees;
- vi. Project Co’s selections for removal; and

b. Table 2:

- i. Forested Area;

- ii. assessment value unit rate;
 - iii. existing area of each Forested Area; and
 - iv. Project Co's selections for areas of removal;
 - 2. identifies the physical locations of all existing trees and Forested Areas using the Tree Valuation Inventory drawings included in the Proposal Extracts, which:
 - a. identify whether each tree or Forested Area or portion thereof will be retained and protected, or removed; and
 - b. match the Tree Valuation Inventory tables described in Section 2-14.15B.1 [*Tree Retention, Removal, and Protection*];
 - 3. identifies the mitigation strategies employed to ensure the health and longevity of all Protected and Preservation Trees; and
 - 4. complies with the Valley Line West LRT Landscape Design and Construction Standards.
- C. The assessment value of trees and Forested Areas identified for relocation or removal in the TRRP Plan submitted within 180 days of the Effective Date shall sum to the Target Tree Compensation Value.
- D. Within 180 days of the Effective Date, survey all trees within the Lands and show the surveyed locations on the updated TRRP for the applicable Work Package.
- 1. if the survey identifies additional trees within the Lands that were not previously identified on the Tree Valuation Inventory tables, the City may, at its discretion, choose to relocate the trees within sixty (60) working days, during the transplant window of May 1 to October 31.
- E. Tree Status Changes:
- 1. Protected Tree to Removal Tree:
 - a. Project Co shall submit an updated TRRP Plan for the applicable Work Package that identifies all revisions to the selections of Removal Tree as identified in the Tree Valuation Inventory tables and a reference to the applicable Final Design;
 - 2. Removal Tree to Protected Tree:
 - a. Project Co shall submit documentation from the Arborist confirming that no more than 30% of the tree has been damaged;
 - b. if no more than 30% of the tree has been damaged, the City will approve, or not approve, the recommended tree status change; and
 - c. Removal Trees shall be protected in the same manner as Protected Trees until the City has confirmed the tree status change.
- F. Prior to the start of Construction of any applicable Work Package:
- 1. submit to the City a letter confirming the current TRRP Plan is accurate for the applicable Work Package; or
 - 2. submit to the City an updated TRRP Plan for the applicable Work Package, which shall identify all revisions to the selections of Preservation Tree, Protection Tree or Removal Tree in the Tree Valuation Inventory tables and a reference to the applicable Final Design;

The Tree Removal Adjustment will be calculated in accordance with Section 2.5 [*Tree Removal Adjustment*] of Schedule 16 [*Payment Mechanism*], based on the Final Tree Reconciliation Report.

- G. Submit to the City a monthly tree reconciliation report, which includes:
1. a list of tree removals completed since the last monthly reconciliation and a cumulative total value of tree removals based on the value of trees established in the Tree Valuation Inventory since Financial Close;
- H. Submit to the City an annual tree reconciliation report, on the anniversary of the Effective Date, which includes:
1. compiled modifications to the TRRP Plan for the year since the Effective Date anniversary;
 2. a list of tree removals completed since the last Effective Date anniversary and a cumulative total value of tree removals based on the value of trees established in the Tree Valuation Inventory since the Effective Date;
 3. all Tree Management Logs since the last Effective Date anniversary; and
 4. all Tree Risk Assessments since the last Effective Date anniversary.
- I. Submit to the City no later than twenty (20) Business Days before the Construction Completion Date a final tree reconciliation report (the "**Final Tree Reconciliation Report**"), which shall be confirmed by the Independent Certifier and include:
1. all modifications to the TRRP Plan since the Effective Date;
 2. a record of tree removals completed during the Construction of the Project; and
 3. a record of the aggregate value of tree removals based on the value of trees established in the Tree Valuation Inventory since the Effective Date.
- J. Commemorative Trees, if identified within the Lands and if removed, shall be replaced with a new tree of the same species planted within 10 m of its original location. Replacement trees shall be 60 mm caliper deciduous or 3 m high coniferous/ evergreen at time of planting.

2-14.15.1 NOT USED

2-14.15.2 Tree Retention

- A. The Tree Valuation Inventory identifies Preservation Trees within the Lands that must not be removed and shall be protected in accordance with Section 2-14.15.4 [*Tree Protection in Critical Root Zones*] of this Schedule.
- B. If there is a change to the Lands boundary, and a tree formerly outside of the Lands is now inside of the Lands, the tree shall be deemed a Preservation Tree.

2-14.15.3 Tree and Vegetation Removal Procedures

- A. Conform to the following tree and vegetation removal procedure requirements, except in Native Forest Reclamation Areas and Naturalization Areas, which are dealt with in Schedule 10 [*Environmental Performance Requirements*]:
1. all removals shall be carried out by an Arborist; and
 2. all tree stumps shall be removed, grubbed, or ground down a minimum of 300 mm below grade.

2-14.15.4 Tree Protection in Critical Root Zones

- A. The Critical Root Zones of all Protected Trees and Removal Trees (before declaration as a Removal Tree) shall be protected from compaction and damage to tree trunks, canopy and root systems. Figure 2-14.15.4 [Critical Root Zones] illustrates the Critical Root Zones A, B and C, which shall be determined as follows:
1. Critical Root Zone A is calculated as half the diameter of the existing tree canopy (dripline).
 2. Critical Root Zone B is calculated as equal to the diameter of the existing tree canopy (dripline).
 3. Critical Root Zone C is calculated as twice the diameter of the existing tree canopy (dripline).

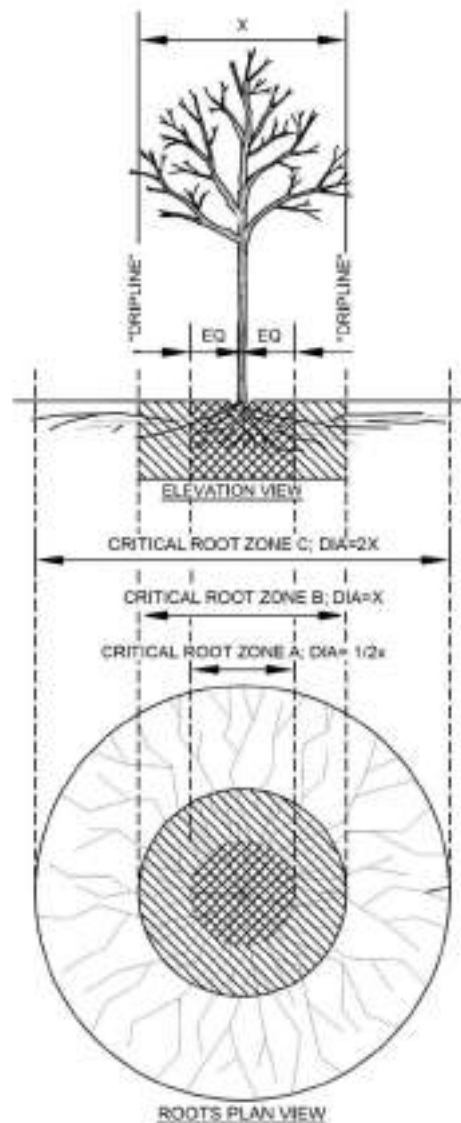

Figure 2-14.15.4: Critical Root Zones

- B. Critical Root Zones A and B shall be protected with an 1800 mm high temporary metal construction fence, installed and pinned in place along the outer perimeter of Critical Root Zone B prior to any construction within 20 m of the tree, except where Critical Zone B:

1. overlaps an active lane of traffic. In this case, the perimeter fence shall be installed within 500 mm of the back of curb;
 2. overlaps an active walkway or SUP. In this case, the perimeter fence shall be installed 300 mm from the edge of a sidewalk or 600 mm from the edge of an SUP; or
 3. overlaps a primary access to a residential property. In this case, the perimeter fence shall be installed such that a minimum 1500 mm access path is maintained to each residential property.
- C. A sign with yellow background and minimum size of 300 mm x 500 mm shall be mounted on each tree protection fence. The signs shall include:
1. a diagram illustrating the tree protection zone in accordance with Figure 2-14.15.4 [*Critical Root Zones*];
 2. contact information, including phone number, for the Arborist who is responsible for modifications to tree protection fence and tree damage evaluation;
 3. Tree Identification Number and assessment value for each tree within the temporary construction fence; and
 4. the following text: "This fence protects the trees within its perimeter. This fence shall not be removed or adjusted."
- D. The following activities are not permitted in Critical Root Zone A:
1. stockpiling of materials, refuse or debris;
 2. storage of chemicals;
 3. staging area or storage of equipment;
 4. use as haul road or construction access area;
 5. trenching;
 6. raising or lowering existing grade; or
 7. root pruning.
- E. The following activities are not permitted in Critical Root Zone B:
1. stockpiling of refuse, debris or materials;
 2. storage of chemicals;
 3. staging area or storage of equipment;
 4. use as haul road or construction access area, except when:
 - a. using an existing concrete or pavement surface that is designed to support required loading; or
 - b. using steel plates or timbers to support required loading and prevent soil compaction;
 5. trenching or excavation, except:
 - a. when less than one-third (1/3) of Critical Root Zone B will be disturbed;

6. raising or lowering existing grade, except when:
 - a. grade is raised or lowered less than 100 mm from existing grade; or
 - b. less than one-third (1/3) of Critical Root Zone C is raised or lowered more than 100 mm from existing grade; or
 7. root pruning.
- F. The following activities are not permitted in Critical Root Zone C:
1. stockpiling of refuse, debris or materials that may be harmful to the health of the tree;
 2. stockpiling of any material for more than four (4) weeks;
 3. storage of chemicals;
 4. staging area or storage of equipment;
 5. use as haul road or construction access area, except when:
 - a. using an existing concrete or pavement surface that is designed to support the required loading; or
 - b. using steel plates, timbers or minimum 200 mm depth shredded wood mulch to support required loading and prevent soil compaction;
 6. trenching or excavation, except:
 - a. when less than two-thirds (2/3) of Critical Root Zone C will be disturbed; or
 7. raising or lowering existing grade, except when:
 - a. grade is raised or lowered less than 100 mm from existing grade; or
 - b. less than two-thirds (2/3) of Critical Root Zone C is raised or lowered more than 100 mm from existing grade.
- G. Work within Critical Root Zone A shall be conducted in the following manner:
1. at a minimum, while work is occurring within Critical Root Zone A, a layer of 200 mm depth shredded wood mulch on geotextile fabric shall be installed over Critical Root Zone A.
 2. equipment and activities within Critical Root Zone A must not compact soil or have a tire or track pressure exceeding 42 kPa, with maximum axle loads below 5.5 tonnes. Driving on soils that are wetter than their plastic limit, as defined in ASTM Standard D 4318, is not permitted.
- H. Work within Critical Root Zone B shall be conducted in the following manner:
1. equipment and activities within Critical Root Zone B must not compact soil or have a tire or track pressure exceeding 42k Pa, with maximum axle loads below 5.5 tonnes. Driving on soils that are wetter than their plastic limit, as defined in ASTM Standard D 4318, is not permitted.
- I. Record the date, description and details of all tree protection procedures and measures in Critical Root Zones in the Tree Management Log.

2-14.15.5 Root Management Procedures

- A. Prior to construction within a Work Package, identify tree roots within Critical Root Zone C that will require root pruning to accommodate construction activities such as excavation and trenching.
 - 1. Provide the City with a five (5) month window to root prune trees identified by Project Co.
- B. If roots of Protected Trees or Removal Trees (before declaration as a Removal Tree), are encountered in Critical Root Zone C during Construction, the following shall apply:
 - 1. any roots between 10 mm and 50 mm in diameter damaged during Construction shall be exposed to sound tissue and cleanly cut with a saw or pruning shears.
 - 2. any roots over 50 mm in diameter damaged or encountered during Construction shall be dealt with according to the following procedure:
 - a. the Arborist shall evaluate the root to determine the resulting level of damage to the overall tree if the root is cut;
 - b. the Arborist shall review the Tree Management Log to ensure that severing the root will not cause cumulative tree damage equal to or greater than 30%;
 - c. the Arborist shall determine whether these roots need to be cut or avoided;
 - d. if the root is to be cut, Project Co shall notify the City at least forty-eight (48) hours prior to providing a five (5) Business Day window for the City to prune the root; and
 - e. the Arborist shall record the following information in the Tree Management Log:
 - i. the date when the root was encountered;
 - ii. the construction procedures and/or circumstances leading to the root being encountered;
 - iii. the level of anticipated tree damage, shown as percentage of entire tree including tree trunk, canopy and root system, if the root is cut; and
 - iv. the decision made regarding cutting or avoiding the root.
- C. If roots of Preservation Trees are encountered in Critical Root Zone C during Construction, the following shall apply:
 - 1. any roots between 10 mm and 50 mm in diameter damaged during Construction shall be exposed to sound tissue and cleanly cut with a saw or pruning shears;
 - 2. if any roots greater than 50 mm in diameter are encountered, Project Co shall notify the City at least forty-eight (48) hours prior to providing a five (5) Business Day window for the City to evaluate the root; and
 - 3. at the discretion of the City, the City may prune the root or require Project Co to avoid the root during Construction.
- D. Tree roots exposed in Critical Root Zones A, B, and C during Construction shall:
 - 1. be covered in layers of wet burlap;
 - 2. be monitored daily by the Arborist with respect to tree health and burlap moisture level; and
 - 3. be maintained by soaking the burlap at a minimum every three (3) days.

- E. Record the date, description and details of all root pruning procedures in the Tree Management Log.

2-14.15.6 Branch Management Procedures

- A. Prior to Construction within a Work Package, identify tree branches that will require pruning to accommodate construction access and other construction activities, and provide the City with a five (5) month window to prune trees identified by Project Co.
- B. During Construction, if additional branches of Protection Trees or Removal Trees (before declaration as a Removal Tree), require pruning to accommodate access or other construction activities, notify the City forty-eight (48) hours prior to providing a five (5) Business Day window for the City to complete pruning activities.
- C. Subject to the provisions of this Section 2-14.15.6 [*Branch Management Procedures*] and at the discretion of the City, the City may prune the branch of a Preservation Tree or require Project Co to avoid damaging the branch of a Preservation Tree.
- D. Project Co shall be responsible for ensuring that the pruning windows in this Section 2-14.15.6 [*Branch Management Procedures*] comply with the following seasonal requirements:
 - 1. elms shall only be pruned between October 1 and March 31;
 - 2. deciduous trees, not including maples and birches, shall only be pruned between October 1 and May 1;
 - 3. coniferous trees, maples and birches shall only be pruned between June 1 and July 31; and
 - 4. shrub pruning and minor tree branch pruning, except for elms, may be conducted in any season.
- E. Record the date, description and details of all pruning procedures in the Tree Management Log.

2-14.15.7 Procedures for Trees Damaged During Construction

- A. This section applies after the start of work in the applicable work area.
- B. Damage to trees is defined as any injury or physical damage occurring to the trunk, canopy or root system of a Protected Tree, Preservation Tree, Removal Tree or a tree located outside of the Lands. This includes damage from:
 - 1. Construction activities; and
 - 2. root or branch pruning, as identified by Project Co, to accommodate construction or access, regardless of who conducted the pruning.
- C. Damage to any part of a Protected Tree, Preservation Tree, Removal Tree or a tree located outside of the Lands, including roots, trunk and canopy, shall be evaluated by the Arborist within twenty-four (24) hours of damage incident. Depending on the level of damage to the tree, the following procedures shall occur:
 - 1. the Arborist shall conduct a Tree Risk Assessment and include a detailed Tree Risk Assessment report in the Tree Management Log. The Tree Risk Assessment report shall include photo documentation with, at a minimum:
 - a. an image of the entire tree; and
 - b. images of the damaged areas of the tree, including a ruler or tape measure to indicate scale;

2. all tree work shall be carried out in compliance with *ANSI Z133 – for Arboricultural Operations – Safety Requirements*;
3. Project Co shall submit detailed written recommendations to rectify tree damage based on the Tree Risk Assessment;
4. if damage to a Protected Tree is less than 30% of the entire tree, including tree trunk, canopy and root system the following procedures shall apply:
 - a. the Arborist shall determine, based on records in the Tree Management Log, whether cumulative damage to the tree during Construction has resulted in total damage equal or greater than 30% of the entire tree, including tree trunk, canopy and root system and:
 - i. if cumulative damage is equal or greater than 30%, procedures listed in Section 2-14.15.7C.5 [*Procedures for Trees Damaged During Construction*] shall apply;
 - b. the Arborist shall evaluate and record the following information in the Tree Management Log:
 - i. species;
 - ii. date of damage incident;
 - iii. construction procedures and/or circumstances causing the damage;
 - iv. level of damage, shown as percentage of entire tree, including tree trunk, canopy and root system; and
 - v. methods used to rectify damage and any additional measures required to protect the tree from further damage; and
 - c. the Arborist shall determine and perform tree damage correction measures within six (6) Business Days of the damage incident; and
5. if damage to a Protected Tree is equal to or greater than 30% of the entire tree, including tree trunk, canopy and root system the following procedures shall apply:
 - a. notify the City of the damage incident within forty-eight (48) hours of damage incident;
 - b. the Arborist shall evaluate and record the following information in the Tree Management Log:
 - i. species;
 - ii. date of damage incident;
 - iii. construction procedures and/or circumstances causing the damage; and
 - iv. level of damage, shown as percentage of entire tree, including tree trunk, canopy and root system; and
 - c. provide the City with uninterrupted access to the tree for a four (4) Business Day window commencing immediately after notifying the City of the damage incident. During this window, the City will perform tree damage correction measures and post Construction care. If the City determines that the damage to a Protected Tree requires its removal, then that tree shall be deemed removed in the calculation of the Actual Tree Compensation Value.

2-14.16 LOW IMPACT DEVELOPMENT FACILITIES

- A. LID Facilities shall be designed and constructed in accordance with the following standards and guidelines (in the event of any conflict, ambiguity or inconsistency between or among the requirements of such standards and guidelines, the requirements shall apply in the order listed): the LID Design Standards, the City of Edmonton Low Impact Development Best Management Practices Design Guide Edition 1.1, and the City of Edmonton Low Impact Development Construction Inspection & Maintenance Guide Edition 1.0. In the event of any conflict, ambiguity or inconsistency between or among the requirements for LID Facilities set out in this Section 2-14 [*Landscape Architecture*] and the above referenced standards and guidelines, the requirements of this Section 2-14 [*Landscape Architecture*] shall prevail.
- B. Notwithstanding Section 2-14.16A [*Low Impact Development Facilities*], all LID Facilities located in the Under Guideway Landscape Area as described in Section 2-14.6.5 [*Under Guideway Landscape Area Special Requirements*] shall be in accordance with 2-14.6.5.3C [*Area Specific Requirements*] and Appendix 5-2C [*Under Guideway Landscape Area Drawings*] of this Schedule.
- C. Major outlets and inlets of LID Facilities shall be landscaped with plant materials and boulders to provide visual screening.

2-14.17 LANDSCAPE SUB-DRAINAGE SYSTEM

- A. A sub-drainage system shall be provided in all locations where trees, including trees in soil cells, are to be planted in Roadway Boulevard Landscape Areas and Roadway Median Landscape Areas, except that:
 - 1. the sub-drainage system is not required in locations where five (5) or less trees are planted in a single trench.
- B. The sub-drainage system shall be connected to, but is not part of, the City drainage infrastructure and shall gravity discharge to a City catch basin or storm manhole, whichever is closer.
- C. Provide a Manufacturer Warranty for sub-drainage systems for a minimum of twenty (20) years.

2-14.18 STRUCTURAL SOIL CELLS

- A. Submit detailed technical maintenance and operations plans for all Structural Soil Cell systems and components within the Infrastructure:
 - 1. the plans shall be submitted with each applicable landscape Final Design submission;
- B. Structural Soil Cell system components shall:
 - 1. have been manufactured and on the market for a minimum of ten (10) years;
 - 2. include a Manufacturer Warranty for Soil Cell System components for a minimum of twenty (20) years;
 - 3. include inlets, including sediment basins, for Structural Soil Cells used as Stormwater Management Facilities;
 - 4. include soil inspection ports with direct access to the soil to permit access for “Guelph Permeameter” testing, and soil grab sampling;
 - 5. where trees are not irrigated as part of a LID drainage system, include aeration/irrigation vents and perforated air/water distribution piping;

6. include an under-drainage system and outlets for Structural Soil Cells used as Stormwater Management Facilities or for tree trenches;
 7. be integrated into the overall Structural Soil Cell system design and be integrated with the streetscape design requirements for Structural Soil Cell maintenance structures, such as access locations and sediment catch basins;
 8. be designed for freeze and thaw cycle if used as Stormwater Management Facilities; and
 9. mitigate buildup of road salts and walkway de-icing agents within planting soils if used as Stormwater Management Facilities.
- C. Coordination and written agreements with Utility Companies shall be required if franchise Utilities cross through or are located within Structural Soil Cells.
- D. All Structural Soil Cells shall be registered as buried Utilities with the City.
- E. Structural Soil Cells are not permitted to extend below Roadways or concrete verges.

2-14.19 TREE GRATES

- A. Where tree grates are provided in the Downtown Opportunity Area and the Jasper Place Opportunity Area, they shall conform to the requirements of Section 2-4.7 [Downtown Opportunity Area Special Requirements], Section 2-4.8 [Jasper Place Opportunity Area Special Requirements], Appendix 5-2A [102 Avenue – 107 Street Streetscape Drawings] and Appendix 5-2B [Jasper Place Opportunity Area Streetscape Drawings] of this Schedule.
- B. Notwithstanding Section 2-14.19A [*Tree Grates*] of this Schedule, all tree grates shall be:
1. “Jamison” by Urban Accessories or alternate acceptable to the City; and
 2. cast iron, raw natural finish.
- C. All tree grates shall meet HS 20 loading requirements and:
1. shall withstand proof test loading to 7257 kg concentrated on a 254 mm x 508 mm plate and held for one (1) minute, with no visible deflection or failure; and
 2. shall be supported on a separate, galvanized structural support frame.
- D. All tree grates shall be supplied by a manufacturer having a minimum twenty (20) years tree grate manufacturing experience.
- E. Provide a Manufacturer Warranty for tree grates for a minimum of one (1) year.

2-14.20 VERGES

- A. Roadway Boulevard Landscape Areas, Trackway Boulevard Landscape Areas, Roadway Median Landscape Areas and Roadway Island Landscape Areas require a 500 mm concrete verge adjacent to all locations where shrub beds are to be provided.
1. Verges shall be in accordance with drawing #5010 or #5011 Valley Line West LRT Roadways Design and Construction Standards.

2-14.21 TOPSOIL AND LID SOILS

- A. All topsoil shall conform to the Valley Line West LRT Landscape Design and Construction Standards.

- B. All LID soil shall conform to the LID Design Standards and the Valley Line West LRT Landscape Design and Construction Standards.

2-14.22 WOOD BUMPER POSTS

- A. All wood bumper posts shall conform to Drawing #LA404 of the Valley Line West LRT Landscape Design and Construction Standards.

2-14.23 IRRIGATION

- A. Passive irrigation systems are permitted in accordance with Sections 2-14.6.5 [*Under Guideway Landscape Area Special Requirements*] of this Schedule.
- B. Permanent active irrigation systems are not permitted in Landscaped Areas, except when existing active irrigation systems are impacted by Construction, in which case they shall be reinstated.
- C. Temporary active irrigation systems are permitted for landscape establishment but shall be removed by the Landscape and Vegetation Handback Date.

2-14.24 SHRUB BEDS

- A. Shrub beds shall include shrubs, perennials, or both shrubs and perennials.
- B. Not Used.
- C. Not Used.
- D. Not Used.
- E. Shrub beds shall be provided with an edge as follows:
 - 1. all planting beds adjacent to turf shall have a well-defined edge in accordance with Drawing #LA108 and #LA109 of the Valley Line West LRT Landscape Design and Construction Standards;
 - 2. PVC edging is not permitted; and
 - 3. edging shall be securely installed to prevent movement.
- F. Notwithstanding Section 2-14.24B [*Shrub Beds*] of this Schedule, where shrub beds are located in a Roadway Boulevard Landscaped Area, Trackway Boulevard Landscape Area or in a Roadway Median Landscape Area:
 - 1. plant materials located within 2 m from the face of curb shall be selected from Table 2-14.29.10 [*Shrub and Perennial Species for Roadway Boulevard and Roadway Median Landscape Areas*] of this Schedule; and
 - 2. plant materials located beyond 2 m from the face of curb may be selected from Table 2-14.29.6 [*Shrub and Perennial Species for Landscape Areas*] or Table 2-14.29.10 [*Shrub and Perennial Species for Roadway Boulevard and Roadway Median Landscape Areas*] of this Schedule.

2-14.25 WEED BARRIER FABRIC

- A. Weed barrier fabric shall not be installed in any shrub beds or tree planting trenches or pits.

2-14.26 TREE ROOT BARRIER

- A. Where tree root barriers are required, they shall be:

1. minimum 600mm depth; and
 2. securely installed to prevent movement from freezing ground.
- B. Provide a Manufacturer Warranty for tree root barriers for a minimum of twenty (20) years.

2-14.27 BOULDERS

- A. The use of boulders is encouraged to provide interest in the landscape design.
- B. Locate boulders in shrub beds, rip rap, and other non-mowed areas.
- C. When placed in a median or adjacent to a Roadway, boulders shall have a minimum horizontal clearance to the adjacent Roadway that adheres to the requirements of Section 4-1.8.2 [*Horizontal Clearances*] of this Schedule;

2-14.28 MULCHES

- A. All tree and shrub bed areas shall use mulches which conform to the Valley Line West LRT Landscape Design and Construction Standards.
- B. Native Forest Reclamation Areas and Naturalization Areas shall not use mulch, except as specified in Schedule 10 [*Environmental Performance Requirements*].

2-14.29 PLANT MATERIAL

- A. This Section 2-14.29 [*Plant Material*] sets out the Design and Construction requirements for plant material.

2-14.29.1 General Plant Selection Requirements

- A. Plant material selection and sizing shall conform to the Valley Line West LRT Landscape Design and Construction Standards.
- B. Except as noted in Section 2-14.5 [*Required Planting Setbacks*] of this Schedule, perennial and shrub beds must be planted in a manner such that the planting beds will have 100% plant material coverage when the plants reach maturity.
- C. Mass plantings shall provide continued visual interest without introducing visual clutter or monotony and:
1. the size and diversity of mass plantings shall reflect the context and Character Zone in which they are planted;
 2. mass plantings adjacent to pedestrian routes shall be medium in size, whereas mass plantings adjacent to Roadways or Trackways, but not adjacent to pedestrian routes, shall be large in size; and
 3. adjacent pedestrian, Roadway or Trackway focused mass plantings shall be complementary to each other, maintaining a sense of visual continuity despite a differentiation in planting size.
- D. Plant materials that bear edible foliage or fruit are not permitted in Known Contaminated Locations.

2-14.29.2 Plant Material Supply Source

- A. Plant Material supply sources shall conform to the Valley Line West LRT Landscape Design and Construction Standards.

- B. Native Forest Reclamation Area and Naturalization Area plant sourcing requirements shall be developed as part of the Native Forest Reclamation Plan and the Naturalization Plan as required in Schedule 10 [Environmental Performance Requirements].

2-14.29.3 Tree Species and Spread

- A. All trees in the Landscaped Areas, not including Native Forest Reclamation Areas, Naturalization Areas, Stormwater Management Facilities, Downtown Opportunity Area, and Jasper Place Opportunity Area, shall be selected from Table 2-14.29.3 [Tree Species for Landscaping] of this Schedule.

Table 2-14.29.3: Tree Species for Landscaping

Scientific Name	Common Name	Tree Canopy Width at Maturity (m)
Canopy Trees		
Fraxinus pennsylvanica 'Patmore'	Patmore Green Ash	8
Fraxinus pennsylvanica 'Bergeson'	Bergeson Green Ash	8
Fraxinus pennsylvanica 'Prairie Spire'	Prairie Spire Green Ash	8
Fraxinus pennsylvanica	Green Ash (seedless varieties only)	8
Malus x adstringens 'Durleo'	Gladiator Crabapple	3
Quercus macrocarpa	Bur Oak	8
Tilia americana	American Linden	8
Tilia cordata	Littleleaf Linden	10
Tilia x flavescens 'Dropmore'	Dropmore Linden	8
Ulmus americana	American Elm	10
Ulmus americana 'Brandon'	Brandon Elm	8
Deciduous Ornamental Trees		
Acer ginnala	Amur Maple	4
Betula papyrifera var. papyrifera	Paper Birch (only in naturalized parks)	8
Crataegus x mordenensis 'Snowbird'	Snowbird Hawthorn	5
Crataegus x mordenensis 'Toba'	Toba Hawthorn	4
Malus x adstringens (multiple varieties)	Ornamental Flowering Crabapple	5
Prunus maackii	Amur Cherry	8
Prunus virginiana 'Schubert'	Schubert Chokecherry	8
Populus x jaackii 'Northwest'	Northwest Poplar (naturalized parks)	10
Sorbus americana	American Mountain Ash	6
Sorbus decora	Showy Mountain Ash	4
Syringa reticulata 'Ivory Silk'	Ivory Silk Tree Lilac	5
Tilia cordata	Little-leaf Linden	10
Tilia x flavescens	Dropmore Linden	8
Malus x 'Jeflite'	Startlite Crabapple	5
Malus x 'Emerald Spire'	Emerald Spire Crabapple	5

Scientific Name	Common Name	Tree Canopy Width at Maturity (m)
Malus x 'Jefspire'	Purple Spire Crabapple	5
Syringa reticulata	Japanese Tree Lilac	5
Ornamental Coniferous Trees		
Abies balsamea	Balsam Fir	4
Larix laricina	Tamarack	8
Larix sibirica	Siberian Larch	8
Picea abies	Norway Spruce	8
Picea glauca	White Spruce	8
Picea glauca var. densata	Black Hills Spruce	9
Picea pungens	Colorado Spruce	8
Picea mariana	Black Spruce	3
Pinus banksiana	Jack Pine	4
Pinus cembra	Swiss Stone Pine	4
Pinus contortus var. latifolia	Lodgepole Pine	4
Pinus nigra	Austrian Pine	8
Pinus ponderosa	Ponderosa Pine	10
Pinus sylvestris	Scots Pine	8
Pseudotsuga menziesii	Douglas Fir	8
Columnar Trees		
Amelanchier x grandifolia	Autumn Brilliance Serviceberry	4
Caragana arborescens 'Sutherland'	Sutherland Caragana	3
Malus x baccata 'Columnaris'	Rosthern Crabapple	3
Malus x 'Jefspire'	Purple Spire Crabapple	3
Malus x 'Dreamweaver'	Dreamweaver Crabapple	1
Picea pungens fastigiata	Columnar Colorado Spruce	3
Picea pungens Hoopsii	Hoopsii Colorado Spruce	4
Populus tremula var. erecta	Swedish Columnar Aspen	2
Sorbus aucuparia 'Fastigiata'	Pyramidal Mountain Ash	4
Sorbus aucuparia 'Rossica'	Russian Mountain Ash	4

- B. Picea mariana shall only be permitted in bioswales and naturalization areas.
- C. Plant material shall be appropriate for the planting application, site conditions, and local climatic conditions.
- D. Tree species selections shall consider site specific CPTED principles and sightline concerns.
- E. Tree planting shall incorporate visual interest for the winter season. Winter interest may be introduced in a variety of ways, including use of:
 - 1. coniferous/evergreen plant materials; and/or
 - 2. plant materials that retain colourful or high texture foliage, fruit or stems and branching that contrast with the snow in the winter season.

- F. Selected tree species shall be appropriate for the planting application, site conditions, and local climatic conditions.

2-14.29.4 Tree Species Diversity

- A. Coniferous/deciduous tree mix shall be 60%/40% respectively within open spaces, not including Roadway Boulevard Landscape Areas, Roadway Median Landscape Areas, Roadway Island Landscape Areas, Trackway Boulevard Landscape Areas and parking lots.
- B. To provide Street Tree diversity, Street Tree species shall be consistent within each block and shall alternate between Roadway traffic intersections along the LRT Corridor, as shown in Figure 2-14.29.4 [*Street Tree Species Diversity*] of this Schedule.

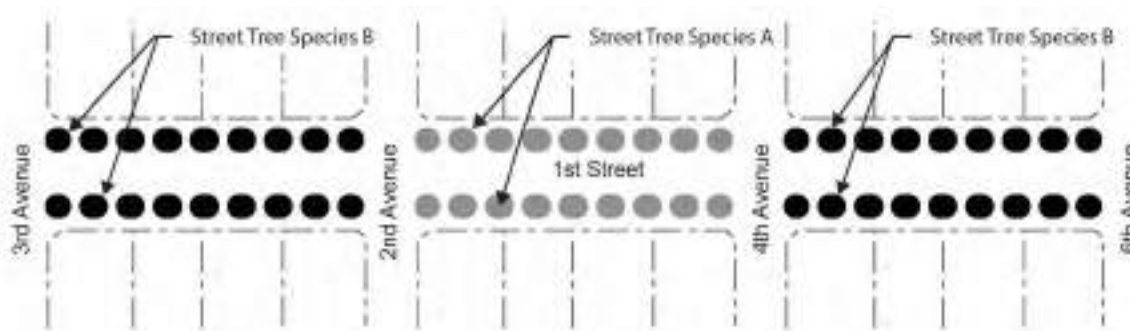

Figure 2-14.29.4: Street Tree Species Diversity

- C. The quantity of trees from any single genus shall not exceed 25% of the total amount of trees along the LRT Corridor.
- D. The quantity of *Fraxinus pennsylvanica* species and cultivars shall not exceed 5% of the total amount of trees along the LRT Corridor.

2-14.29.5 Stormwater Management Facility Plant Material

- A. Plant material below the 1:5 year water line of Stormwater Management Facilities shall be selected from Table 2-14.29.5.1 [*Tree Species for Stormwater Management Facilities*] and 2-14.29.5.2 [*Shrub and Perennial Species for Stormwater Management Facilities*] or from the City of Edmonton, Low Impact Development Best Management Practices Design Guide and City of Edmonton, Low Impact Development Construction, Inspection & Maintenance Guide.

Table 2-14.29.5.1: Tree Species for Stormwater Management Facilities

Scientific Name	Common Name	Tree Canopy Width at Maturity (m)
Evergreen Shrubs		
<i>Populus tremuloides</i>	Trembling Aspen	5
<i>Salix pentandra</i>	Laurel Leaf Willow	10

Table 2-14.29.5.2: Shrub and Perennial Species for Stormwater Management Facilities

Scientific Name	Common Name
<i>Salix integra</i> 'Albomaculata'	Tri-colour Willow

Scientific Name	Common Name
Festuca ovina	Sheep Fescue
Schizachyrium scoparium	Little Bluestem Grass
Agastache foeniculum	Giant Hyssop
Asclepias speciose	Showy Milkweed

- B. Plant spacing, selection and sizing in Stormwater Management Facilities shall conform to the Valley Line West LRT Landscape Design and Construction Standards.

2-14.29.6 Shrub and Perennial Species Selection

- A. All project shrubs and perennials for Landscaped Areas, not including Native Forest Reclamation Areas, Naturalization Areas, and Stormwater Management Facilities, shall be selected from the following Table 2-14.29.6 [*Shrub and Perennial Species for Landscape Areas*].

Table 2-14.29.6: Shrub and Perennial Species for Landscape Areas

Scientific Name	Common Name
Evergreen Shrubs	
Abies balsamea 'nana'	Dwarf Balsam Fir
Abies balsamea 'Montgomery Spruce'	Montgomery Blue Spruce
Juniperus chinensis; Juniperus horizontalis; Juniperus procumbens; Juniperus sabina; Juniperus communis	Horizontal juniper cultivars
Juniperus pfitzeriana 'Old gold'	Old Gold Juniper
Picea abies nidiformis	Nest Spruce
Picea abies pumila	Dwarf Norway Spruce
Picea abies 'Little Gem'	Little Gem Spruce
Microbiota decussata	Russian Cypress
Picea pungens 'globosa'	Globe Blue Spruce
Picea pungens 'Montgomery'	Montgomery Spruce
Pinus mugo 'Mops'	Mops Mugo Pine
Pinus mugo var. Pumillo	Dwarf Mugo Pine
Deciduous Shrubs	
Amelanchier alnifolia	Saskatoon
Acer tataricum 'Hot Wings'	Hot Wings Tatarian Maple
Caragana frutex 'globosa'	Globe Caragana
Caragana pygmaea	Pygmy Caragana
Cornus alba; Cornus stolonifera; Cornus sericea	Dogwood Cultivars
Elaeagnus commutata	Wolf Willow
Shepherdia canadensis	Buffaloberry
Berberis thunbergia sp.	Barberry Cultivars
Diervilla lonicera	Bush Honeysuckle

Scientific Name	Common Name
<i>Euonymus alatus</i>	Winged Burning Bush
<i>Euonymus nana</i> 'Turkestanica'	Turkestan Burning Bush
<i>Hydrangea arborescens</i> 'Anabelle'	Anabelle Hydrangea
<i>Hydrangea paniculata</i> 'Grandiflora'	Pee Gee Hydrangea
<i>Lonicera caerulea</i> ; <i>Lonicera</i> x <i>xylosteroides</i> 'Miniglobe'; <i>Lonicera</i> x <i>xylosteroides</i> 'Emerald Mound'	Honeysuckle Shrub Cultivars
<i>Philadelphus</i> sp.	Mockorange Cultivars
<i>Physocarpus opulifolius</i>	Ninebark Cultivars
<i>Prunus triloba</i> 'Multiplex'	Double Flowering Plum
<i>Potentilla fruticosa</i>	Potentilla Cultivars
<i>Ribes alpinum</i>	Alpine Current
<i>Rosa acicularis</i> ; <i>Rosa woodsii</i> var. <i>woodsii</i>	Native Wild Roses
<i>Rosa rugosa</i> ; <i>Rosa</i> (Explorer series); <i>Rosa</i> (Morden series); <i>Rosa rubrifolia</i> ; <i>Rosa</i> sp.	Hardy Roses
<i>Salix brachycarpa</i> ; <i>Salix purpurea</i>	Willow Shrubs
<i>Sambucus nigra</i> ; <i>Sambucus racemosa</i>	Elderberry
<i>Sorbaria sorbifolia</i>	False Spiraea
<i>Spiraea betulifolia</i> ; <i>Spiraea</i> x <i>bumalda</i> ; <i>Spiraea japonica</i> ; <i>Spiraea</i> sp.	Spiraea Cultivars
<i>Syringa</i> x <i>prestonae</i> ; <i>Syringa meyerii</i> ; <i>Syringa patula</i> ; <i>Syringa</i> (Fairytale series)	Lilacs (Non-Suckering Varieties)
<i>Symphoricarpos</i> sp.	Snowberry
<i>Viburnum opulus</i> 'nana'; <i>Viburnum trilobum</i> ; <i>Viburnum opulus</i> var. <i>americanum</i>	Cranberries
Perennials	
<i>Aconitum</i> sp.	Monkshood Cultivars
<i>Arctostaphylos uva-ursi</i>	Kinnikinnick
<i>Artemisia schmidtiana</i> 'Silver Mound'	Silver Mound Artemisia
<i>Aruncus dioicus</i>	Goatsbeard Cultivars
<i>Campanula carpatica</i>	Carpathian Bellflower Cultivars
<i>Campanula poscharskyana</i>	Serbian Bellflower Cultivars
<i>Chrysanthemum</i> (Morden hybrids)	Morden Chrysanthemum Cultivars
<i>Cimicifuga racemosa</i>	American Bugbane Cultivars
<i>Echinacea purpurea</i>	Purple Coneflower Cultivars
<i>Eupatorium maculatum</i>	Joe Pye Weed
<i>Filipendula rubra</i>	Queen Of The Prairie Cultivars
<i>Geranium</i> sp.	Cranesbill Cultivars
<i>Heliopsis helianthoides</i>	False Sunflower Cultivars
<i>Hemerocallis</i> sp.	Daylily Cultivars

Scientific Name	Common Name
Hosta sp.	Hosta Cultivars
Iris pallida 'variegata'	Variegated Sweet Iris
Iris sibirica	Siberian Iris Cultivars
Liatris spicata	Gayfeather Cultivars
Nepeta x faassenii	Catmint Cultivars
Paeonia sp.	Peony Cultivars
Perovskia atriplicifolia	Russian Sage Cultivars
Phlox paniculata	Garden Phlox Cultivars
Pulmonaria sp.	Lungwort Cultivars
Rudbeckia hirta	Rudbeckia Coneflower Cultivars
Salvia sp. (upright cultivars)	Blue Sage Cultivars
Sedum sp. (upright cultivars)	Tall Stonecrop Cultivars
Solidago canadensis	Golden Rod Cultivars
Trollius sp.	Globeflower Cultivars
Veronica spicata	Spike Speedwell Cultivars
Perennial Groundcovers	
Ajuga reptans	Bugleweed Cultivars
Artemesia stelleriana	Silver Brocade Artemesia
Bergenia cordifolia	Elephant Ears
Cerastium tomentosum	Snow-In-Summer
Convallaria majalis	Lily-Of-The-Valley
Dianthus deltoides	Maiden Pinks Cultivars
Geranium macrorrhizum	Big-Root Cranesbill Cultivars
Lamastrium galeobodon 'Herman's Pride'	Yellow Archangel
Lamium maculatum	Silver Deadnettle Cultivars
Phlox subulata	Moss Phlox Cultivars
Sedum kamtschaticum	Russian Stonecrop Cultivars
Sedum spurium	Dragon's Blood Stonecrop
Stachys byzantina	Lamb's Ears Cultivars
Thymus praecox	Creeping Thyme
Thymus psuedolanguinis	Wooly Thyme
Perennial Ornamental Grasses	
Calamagrostis x acutiflora	Feather Reed Grass Cultivars
Deschampsia cespitosa	Tufted Hair Grass Cultivars
Festuca glauca	Blue Fescue Cultivars
Helictotricon sempervirens	Blue Oat Grass
Phalaris arundinacea	Variegated Ribbon Grass
Vines/Climbing Plants	
Actinidia kolomikta	Arctic Kiwi Vine

Scientific Name	Common Name
Clematis tangutica	Golden Clematis
Clematis alpina	Alpine Clematis Cultivars
Humulus lupulus	Hops
Lonicera x brownii	Vine Honeysuckle
Lonicera dioica	Glaucous Honeysuckle Cultivars
Parthenocissus quinquefolia	Virigia Creeper And Englemann Ivy
Rosa sp. (Explorer series)	Hardy Climbing Rose Cultivars

- B. Selected shrub and perennial species shall be appropriate for the planting application, site conditions, and local climatic conditions.
- C. Shrub and perennial planting plans shall incorporate visual interest throughout all seasons including the winter season. Winter interest may be introduced in a variety of ways, including use of:
 1. coniferous/evergreen plant materials;
 2. shrubs and perennials that remain upright and protrude through snow-cover in the winter season; and/or
 3. plant materials that retain colourful foliage, fruit or stems that contrast with the snow in the winter season.
- D. Plant materials selected for use in Roadway Boulevard Landscape Areas, Trackway Boulevard Landscape Areas, Roadway Median Landscape Areas, which are located within 2.0 m of a Roadway shall be selected from Table 2-14.29.10 [*Perennial Species for Roadway Boulevard Landscape Areas, Trackway Boulevard Landscape Areas and Roadway Median Landscape Areas*].

2-14.29.7 Tree, Shrub and Perennial Plant Spacing

- A. Tree, shrub and perennial spacing, shall conform to the Valley Line West LRT Landscape Design and Construction Standards.
- B. Tree, shrub and perennial spacing shall consider site specific CPTED principles and sightline concerns.
- C. All trees shall be spaced according to the tree canopy width at maturity as set out in Table 2-14.29.3 [*Tree Species for Landscaping*] of this Schedule.
- D. All shrubs and perennials, not including those in Native Forest Reclamation Areas, Naturalization Areas and Stormwater Management Facilities, shall be spaced according to mature plant widths in accordance with *Alberta Yards and Gardens: What to Grow* by Alberta Agriculture Food & Rural Development:
 1. if plant species are not listed in *Alberta Yards and Gardens: What to Grow*, plants shall be spaced according to the mature width listed in an alternate reputable horticultural information resource; and
 2. the mature width of plants may be varied at the City's discretion to promote a full and lush landscape.
- E. All deciduous trees, not including columnar varieties or those planted in Native Forest Reclamation Areas and Naturalization Areas, shall be free of branches from the base to a point not less than 60% of the tree height or 1.5 m above ground and:

1. trees that overhang walkways, pedestrian areas, and Roadways shall be free of branches from the base to a height of at least 2.5 m.
- F. Individual tree spacing may be modified within +/-3 m of the tree canopy size at tree maturity where required to accommodate:
1. car door swings in areas with defined parallel parking stalls;
 2. Utility crossings, accesses, Structures and vaults;
 3. sightlines near driveways, pedestrian crossings, and intersections; or
 4. existing trees.
- G. Where coniferous trees are being used for screening purposes as identified in Section 2-14.6 [*West Edmonton Character Zone Landscape Requirements*] through Section 2-14.10 [*Utility Complex Site Landscaping*] of this Schedule, the minimum spacing may be reduced to:
1. 3.0m for Pinus species; and
 2. 6.0m for Picea species.

2-14.29.8 Native Forest Reclamation Area and Naturalization Area Plant Material

- A. Plant species, spacing, and sizing for Naturalization Areas shall be selected as part of the Native Forest Restoration Plan and the Naturalization Plan as required in Schedule 10 [*Environmental Performance Requirements*].
- B. Notwithstanding 2-14.29.8A [*Native Forest Reclamation Area and Naturalization Area Plant Material*] of this Schedule, where no plant materials are specified, all Native Forest Reclamation Area and Naturalization Area plant species selection, spacing and sizing shall conform to the Valley Line West LRT Landscape Design and Construction Standards.

2-14.29.9 Seeding and Sodding

- A. All turf areas shall be sodded, with the exception of the following turf areas, which may be seeded:
1. areas within the TUC which may be affected by landscape work;
 2. areas within the Aldergrove Park Storm Water Management Facility;
 3. areas within the Lewis Farms Storm Water Management Facility; and
 4. areas in the Under Guideway Landscape Area below the 87 Avenue Elevated Guideway as described in Section 2-14.6.5 [*Under Guideway Landscape Area Special Requirements*] of this Schedule.
- B. Seed mixes used within Native Forest Reclamation Areas and Naturalization Areas, as identified in Schedule 10 [*Environmental Performance Requirements*], shall be determined as part of the Native Forest Reclamation Plan and the Naturalization Plan.

2-14.29.10 Boulevard and Median Plant Materials

- A. All plant materials, excluding trees, in Roadway Boulevard Landscape Areas, Trackway Boulevard Landscape Areas, Roadway Median Landscape Areas, which are located within 2.0 m of a Roadway shall be selected from the following Table 2-14.29.10 [*Perennial Species for Roadway Boulevard Landscape Areas, Trackway Boulevard Landscape Areas and Roadway Median Landscape Areas*].

Table 2-14.29.10: Perennial Species for Roadway Boulevard Landscape Areas, Trackway Boulevard Landscape Areas and Roadway Median Landscape Areas

Scientific Name	Common Name
Perennials	
<i>Alium schoenoprasum</i>	Common Chive
<i>Artemesia</i> sp.	Artemesia species
<i>Aruncus dioicus</i>	Goatsbeard Cultivars
<i>Bergenia cordifolia</i>	Elephant Ears
<i>Echinacea purpurea</i>	Cone Flower Cultivars
<i>Hemerocallis</i> sp.	Daylily Cultivars
<i>Iris pallida</i> 'variegata'	Variegated Sweet Iris
<i>Iris sibirica</i>	Siberian Iris Cultivars
<i>Rheum palmatum</i>	Rhubarb Cultivars
<i>Salvia nemorosa</i>	Salvia Cultivars
<i>Sedum specatabile</i>	Sedum Cultivars
<i>Stachys byzantina</i>	Lamb's Ears Cultivars
<i>Tradescantia</i> sp.	Spiderwort
<i>Veronica spicata</i>	Spike Speedwell Cultivars
Perennial Ornamental Grasses	
<i>Bouteloua gracilis</i>	Blue Grama
<i>Calamagrostis x acutiflora</i>	Feather Reed Grass Cultivars
<i>Deschampsia cespitosa</i>	Tufted Hair Grass Cultivars
<i>Elymus Canadensis</i>	Canada Wild Rye
<i>Festuca glauca</i>	Blue Fescue Cultivars
<i>Helictotricon sempervirens</i>	Blue Oat Grass
<i>Koeleria cristata</i>	Prairie June Grass
<i>Leymus arenarius</i>	Lyme Grass
<i>Luzula sylvatica</i>	Greater Wood Rush
<i>Oryzopsis hymenoides</i>	Indian Rice Grass
<i>Panicum virgatum</i>	Switch Grass Cultivars
<i>Phalaris arundinacea</i>	Variegated Ribbon Grass
<i>Schizachyrium scoparium</i>	Little Bluestem Cultivars
<i>Sesleria argentea</i>	Green Moor Grass
<i>Sporobolus heterolepis</i>	Prairie Dropseed

- B. Selected plant species shall be appropriate for the planting application, site conditions, and local climatic conditions.
1. The typical composition of plant materials shall be one-third dicotyledons and two-thirds monocotyledons.
 2. Dicotyledons shall be planted in distinct masses.

3. Plant materials shall be selected for the expected chloride levels in their respective locations and shall be chloride tolerant as required.
- C. Plantings shall provide visual interest throughout all seasons. Winter interest may be introduced in a variety of ways, including use of:
1. plants materials that remain upright and protrude through snow-cover in the winter season; and
 2. plant materials that retain colourful foliage, fruit or stems that contrast with the snow in the winter season.
- D. Plugs are permitted in Roadway Boulevard and Roadway Median Landscape Areas as follows:
1. plugs are permitted for plant materials from the Poacea family;
 2. prior to Landscape Handback, all dead plant material shall be removed from beds and replaced to create a full bed appearance;
 3. survival of plugs at Landscape Handback shall be a minimum of 90% within each 3m² area;
 4. plugs shall be sized in accordance with the Valley Line West LRT Landscape Design and Construction Standards; and
 5. plugs of spreading plant materials shall be spaced at one-third of the mature spread of the plant in accordance with the book "*Perennial Gardening Guide*" by John M Valleau:
 - a. plant spacing may be varied at the City's discretion..

Section 2-15 - LANDSCAPE ESTABLISHMENT

- A. Without limiting Project Co's obligation to ensure that all Project Work described in Section 2-14 [*Landscape Architecture*] is completed by a date not later than the Construction Completion Date, Project Co shall maintain, water, repair, weed, reseed, replant, reinstall, and conduct other work in accordance with the requirements of Section 2-14 [*Landscape Architecture*], the Valley Line West LRT Landscape Design and Construction Standards and the landscape maintenance plans, and as otherwise required, to ensure that at the Landscape and Vegetation Handback Date, for all Landscaped Areas:
1. 100% of all plant materials are in place and in good horticultural condition;
 2. 100% of all site furnishings are in place and in pristine condition;
 3. all installations and measures are in place and meet the Valley Line West LRT Landscape Design and Construction Standards; and
 4. all areas meet the landscape maintenance outcomes specified in this Section 2-15 [*Landscape Establishment*] and in the Valley Line West LRT Landscape Design and Construction Standards; (collectively, the "**Landscape Handback Requirements**").
- B. Immediately after landscape installation, Project Co shall maintain all aspects of such landscape to the standards set out in the Valley Line West LRT Landscape Design and Construction Standards.
- C. Landscape maintenance practices shall focus on horticultural practices that produce vigorous and healthy plant material.
- D. Landscape maintenance shall provide the following results:
1. clean landscape areas, free of debris and refuse;
 2. aesthetic and high quality spaces;
 3. healthy and vigorous plant material; and
 4. landscape materials and elements free from damage or deterioration.
- E. Landscape maintenance shall employ only ecologically sound practices, including:
1. integrated pest management;
 2. plant health care;
 3. composting;
 4. application of organic mulches;
 5. use of organic fertilisers; and
 6. use of organic or environmentally-friendly weed control products and methods.
- F. Maintenance of existing trees which do not form part of the Infrastructure shall be the responsibility of the City.
- G. As part of the Final Design submission for each of the Landscaping Work Packages, submit to the City a landscape maintenance plan (the "**Landscape Maintenance Plan**") that includes detailed descriptions of maintenance strategies and practices required for all landscape areas. The

Landscape Maintenance Plan shall include strategies and methods for the following aspects of landscape maintenance:

1. weed control;
2. integrated pest management;
3. turf management, including reseeding;
4. fertilisers, top dressings and soil amendments;
5. mulches;
6. pruning;
7. mitigation measures for landscape areas affected by roadway salts; and
8. landscape protection measures to prevent third party damage.

42194693.2

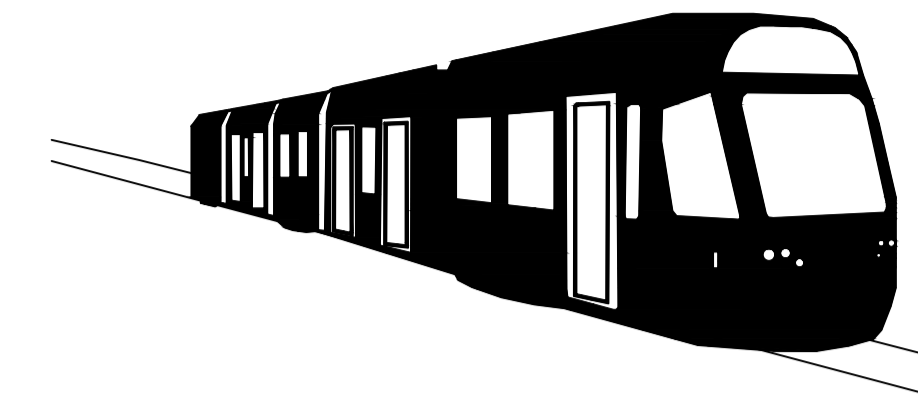

LEWIS FARMS TO DOWNTOWN

VALLEY LINE WEST LRT

102 AVENUE - 107 STREET STREETScape DRAWINGS

APPENDIX 5-2A
SEPTEMBER 18, 2020

THE CITY OF EDMONTON APPROVALS	SIGNATURE	DATE

DRAWING LIST		
SHEET	DESCRIPTION	DRAWING NUMBER
1	COVER SHEET	5-2A-0
2	107 STREET & 104 AVENUE	5-2A-1
3	107 STREET & 103 AVENUE	5-2A-2
4	106-107 STREET & 102 AVENUE	5-2A-3
5	105 STREET & 102 AVENUE	5-2A-4
6	104 STREET & 102 AVENUE	5-2A-5
7	102-103 STREET & 102 AVENUE	5-2A-6

DRAWING LIST		
SHEET	DESCRIPTION	DRAWING NUMBER
8	BENCH DETAIL	5-2A-7
9	AMENITY AREA PLANS	5-2A-8
10	AMENITY AREA CROSS SECTIONS	5-2A-9
11	AMENITY AREA LONGITUDINAL SECTIONS	5-2A-10
12	PLANTING PLANS	5-2A-11
13	ALEX DECOTEAU PARK PLANTING PLANS	5-2A-12
14	AMENITY & MEDIAN PLANTING PLANS	5-2A-13



Prime Consultant



Associate Consultants

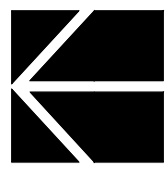

J:\PROJECTS\14000\14801\4854_VALLEY_LINE_LRT_WEST_DESIGN_OE\02_CADD\02_DRAFTING\0220_LANDSCAPE\041_00_LOCAL\REF\06_102_107 AND SPRV\LD-041-102_107 AND SPRV\LANDSCAPE LAYOUT.DWG

DRAWINGS ARE REPRESENTATIVE OF THE ANTICIPATED FINAL OUTCOME AND ARE NOT INTENDED FOR CONSTRUCTION

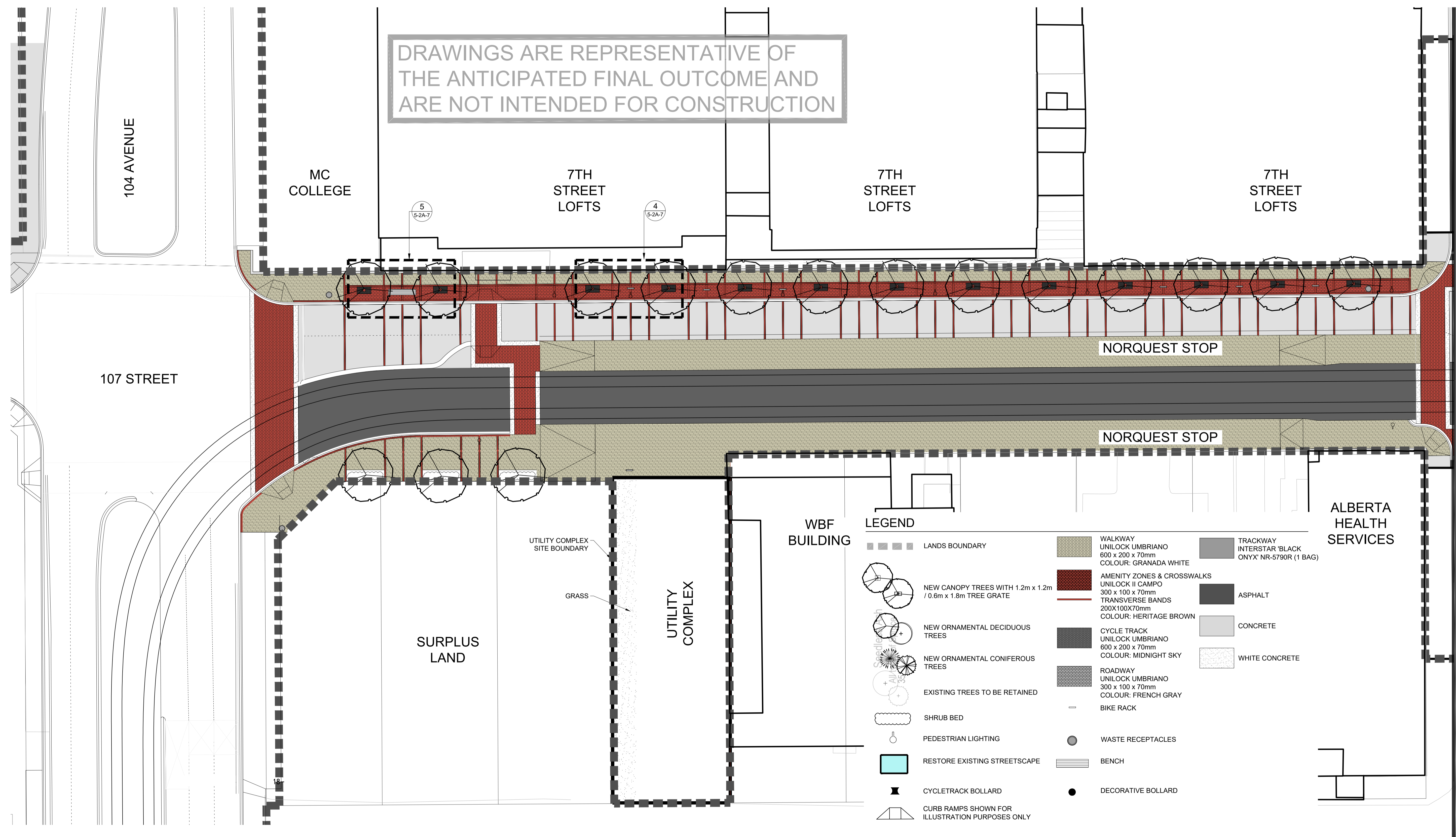

MATCHLINE - REFER TO DRAWING 5-2A-2

VALLEY LINE WEST LRT

no.	description	date	checked
4	ISSUED FOR PA V4	18-9-2020	J.S.
3	ISSUED FOR PA V3	23-7-2020	J.S.
2	ISSUED FOR PA V2	3-7-2020	B.D.
1	ISSUED FOR PA V1R	14-2-2020	B.D.
	revisions		

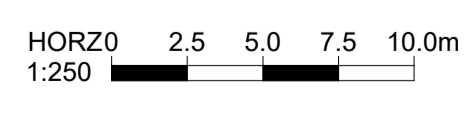

NOT FOR CONSTRUCTION

AECOM
Prime Consultant

Edmonton

HATCH

DIALOG

ISL Engineering and Land Services

M
MOTT MACDONALD

LANDSCAPE
STREETSCAPE DESIGN
107 STREET & 104 AVENUE

DRAWING NO: 5-2A-1

LEGEND

	LANDS BOUNDARY		WALKWAY UNILOCK UMBRIANO 600 x 200 x 70mm COLOUR: GRANADA WHITE		TRACKWAY INTERSTAR 'BLACK ONYX' NR-5790R (1 BAG)
	NEW CANOPY TREES WITH 1.2m x 1.2m / 0.6m x 1.8m TREE GRATE		AMENITY ZONES & CROSSWALKS UNILOCK II CAMPO 300 x 100 x 70mm TRANSVERSE BANDS 200X100X70mm COLOUR: HERITAGE BROWN		ASPHALT
	NEW ORNAMENTAL DECIDUOUS TREES		CYCLE TRACK UNILOCK UMBRIANO 600 x 200 x 70mm COLOUR: MIDNIGHT SKY		CONCRETE
	NEW ORNAMENTAL CONIFEROUS TREES		ROADWAY UNILOCK UMBRIANO 300 x 100 x 70mm COLOUR: FRENCH GRAY		WHITE CONCRETE
	EXISTING TREES TO BE RETAINED		BIKE RACK		WASTE RECEPTACLES
	SHRUB BED		BENCH		DECORATIVE BOLLARD
	PEDESTRIAN LIGHTING				
	RESTORE EXISTING STREETSCAPE				
	CYCLETRACK BOLLARD				
	CURB RAMPS SHOWN FOR ILLUSTRATION PURPOSES ONLY				

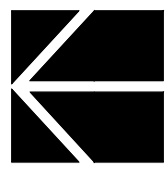

J:\PROJECTS\14000\14854_VALLEY_LINE_LRT_WEST_DESIGN_OE02_CADD\20_LANDSCAPE\041_00_LOCAL_XREF\06_102_107 AND SPRING STREETS LAYOUT.DWG

DRAWINGS ARE REPRESENTATIVE OF THE ANTICIPATED FINAL OUTCOME AND ARE NOT INTENDED FOR CONSTRUCTION

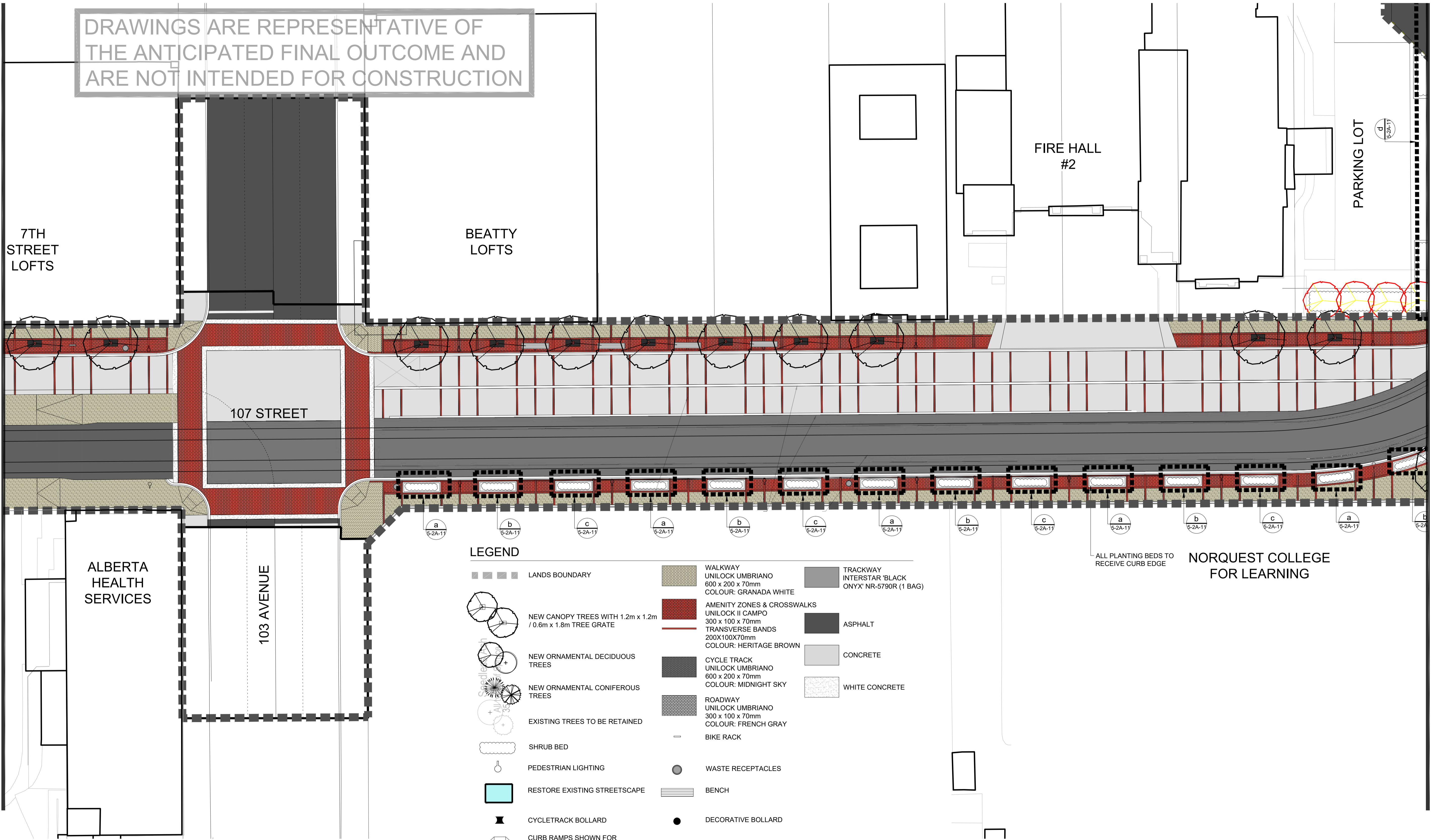

MATCHLINE - REFER TO DRAWING 5-2A-1

MATCHLINE - REFER TO DRAWING 5-2A-3

VALLEY LINE WEST LRT

LEGEND

- LANDS BOUNDARY
- WALKWAY
UNILOCK UMBRIANO
600 x 200 x 70mm
COLOUR: GRANADA WHITE
- AMENITY ZONES & CROSSWALKS
UNILOCK II CAMPO
300 x 100 x 70mm
TRANSVERSE BANDS
200X100X70mm
COLOUR: HERITAGE BROWN
- CYCLE TRACK
UNILOCK UMBRIANO
600 x 200 x 70mm
COLOUR: MIDNIGHT SKY
- ROADWAY
UNILOCK UMBRIANO
300 x 100 x 70mm
COLOUR: FRENCH GRAY
- BIKE RACK
- WASTE RECEPTACLES
- BENCH
- DECORATIVE BOLLARD
- TRACKWAY
INTERSTAR BLACK
ONYX NR-5790R (1 BAG)
- ASPHALT
- CONCRETE
- WHITE CONCRETE
- NEW CANOPY TREES WITH 1.2m x 1.2m / 0.6m x 1.8m TREE GRATE
- NEW ORNAMENTAL DECIDUOUS TREES
- NEW ORNAMENTAL CONIFEROUS TREES
- EXISTING TREES TO BE RETAINED
- SHRUB BED
- PEDESTRIAN LIGHTING
- RESTORE EXISTING STREETSCAPE
- CYCLETRACK BOLLARD
- CURB RAMPS SHOWN FOR ILLUSTRATION PURPOSES ONLY

ALL PLANTING BEDS TO RECEIVE CURB EDGE

no.	description	date	checked
4	ISSUED FOR PA V4	18-9-2020	J.S.
3	ISSUED FOR PA V3	23-7-2020	J.S.
2	ISSUED FOR PA V2	3-7-2020	B.D.
1	ISSUED FOR PA V1R	14-2-2020	B.D.
	revisions		

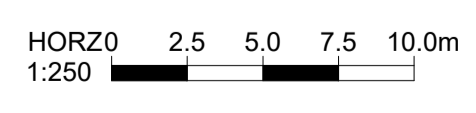

NOT FOR CONSTRUCTION



LANDSCAPE STREETSCAPE DESIGN
107 STREET & 103 AVENUE

DRAWING NO: 5-2A-2

J:\PROJECTS\14000\14001\4854_VALLEY_LINE_LRT_WEST_DESIGN_OE02_CADD\20_DRAFTING\2020_LANDSCAPE\041_102_107 AND SPRINGWAY\041-102_107 AND SPRINGWAY\041-102_107 AND SPRINGWAY_LAYOUT.DWG



MATCHLINE - REFER TO DRAWING 5-2A-2

MATCHLINE - REFER TO DRAWING 5-2A-4

VALLEY LINE WEST LRT

DRAWINGS ARE REPRESENTATIVE OF THE ANTICIPATED FINAL OUTCOME AND ARE NOT INTENDED FOR CONSTRUCTION

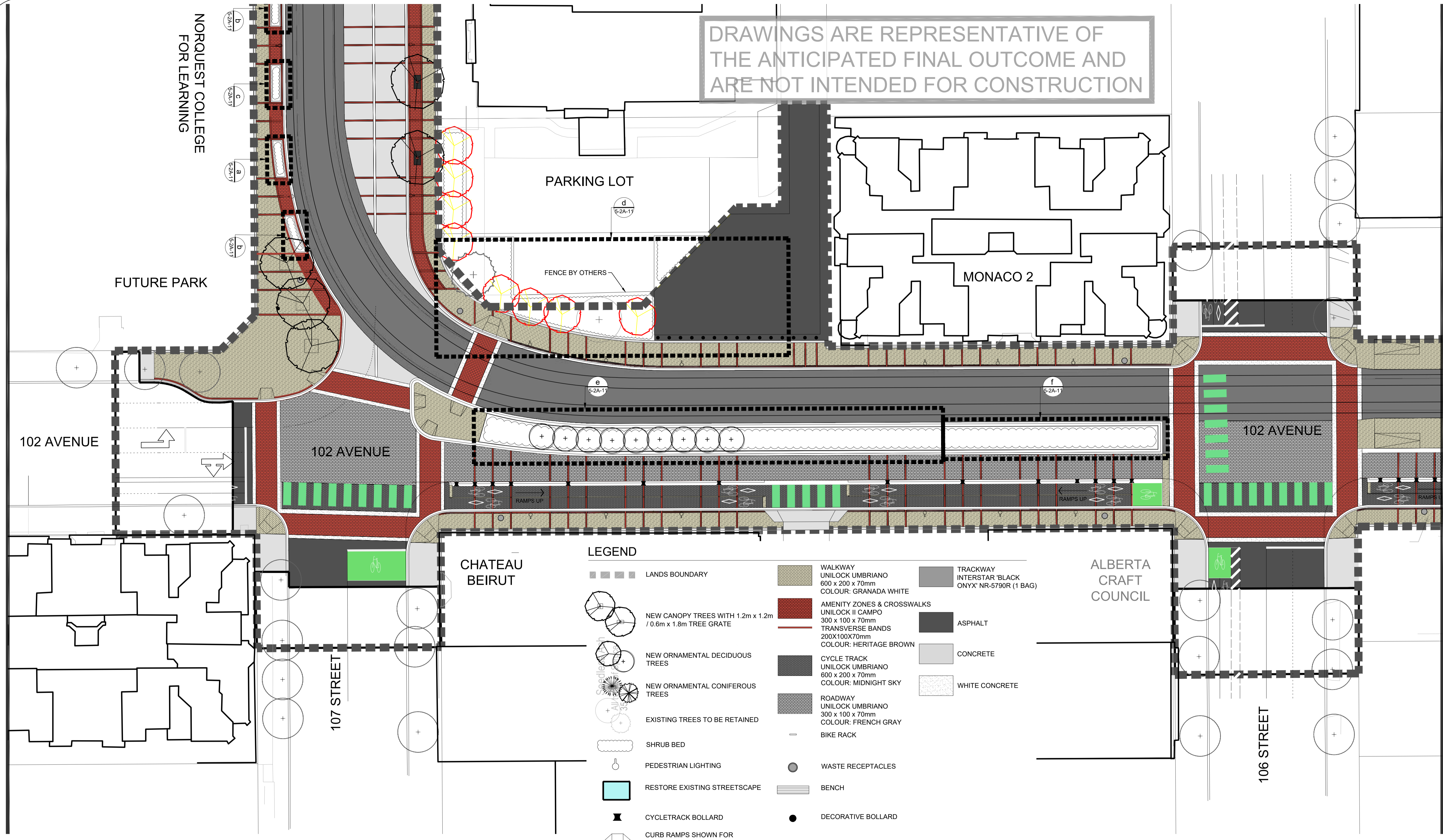

LEGEND

- LANDS BOUNDARY
- NEW CANOPY TREES WITH 1.2m x 1.2m / 0.6m x 1.8m TREE GRATE
- NEW ORNAMENTAL DECIDUOUS TREES
- NEW ORNAMENTAL CONIFEROUS TREES
- EXISTING TREES TO BE RETAINED
- SHRUB BED
- PEDESTRIAN LIGHTING
- RESTORE EXISTING STREETSCAPE
- CYCLETRACK BOLLARD
- CURB RAMPS SHOWN FOR ILLUSTRATION PURPOSES ONLY
- WALKWAY UNILOCK UMBRIANO 600 x 200 x 70mm COLOUR: GRANADA WHITE
- AMENITY ZONES & CROSSWALKS UNILOCK II CAMPO 300 x 100 x 70mm TRANSVERSE BANDS 200X100X70mm COLOUR: HERITAGE BROWN
- CYCLE TRACK UNILOCK UMBRIANO 600 x 200 x 70mm COLOUR: MIDNIGHT SKY
- ROADWAY UNILOCK UMBRIANO 300 x 100 x 70mm COLOUR: FRENCH GRAY
- BIKE RACK
- WASTE RECEPTACLES
- BENCH
- DECORATIVE BOLLARD
- TRACKWAY INTERSTAR 'BLACK ONYX' NR-5790R (1 BAG)
- ASPHALT
- CONCRETE
- WHITE CONCRETE

no.	description	date	checked
4	ISSUED FOR PA V4	18-9-2020	J.S.
3	ISSUED FOR PA V3	23-7-2020	J.S.
2	ISSUED FOR PA V2	3-7-2020	B.D.
1	ISSUED FOR PA V1R	14-2-2020	B.D.
	revisions		

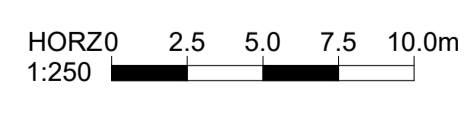

NOT FOR CONSTRUCTION

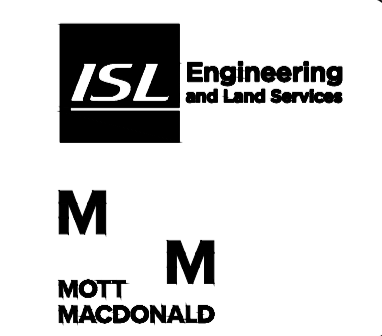

LANDSCAPE STREETScape DESIGN
106-107 STREET & 102 AVENUE

DRAWING NO: 5-2A-3

JOHNSON / September 14, 2020 / G:\PROJECTS\1400014854_VALLEY_LINE_LRT_WEST_DESIGN_OE102_CADD\20_DRAFTING\2020_LANDSCAPE\041_00_LOCAL_XREF\06_102_107 AND SPRING STREETScape LAYOUT.DWG



MATCHLINE - REFER TO DRAWING 5-2A-3

MATCHLINE - REFER TO DRAWING 5-2A-5

VALLEY LINE WEST LRT

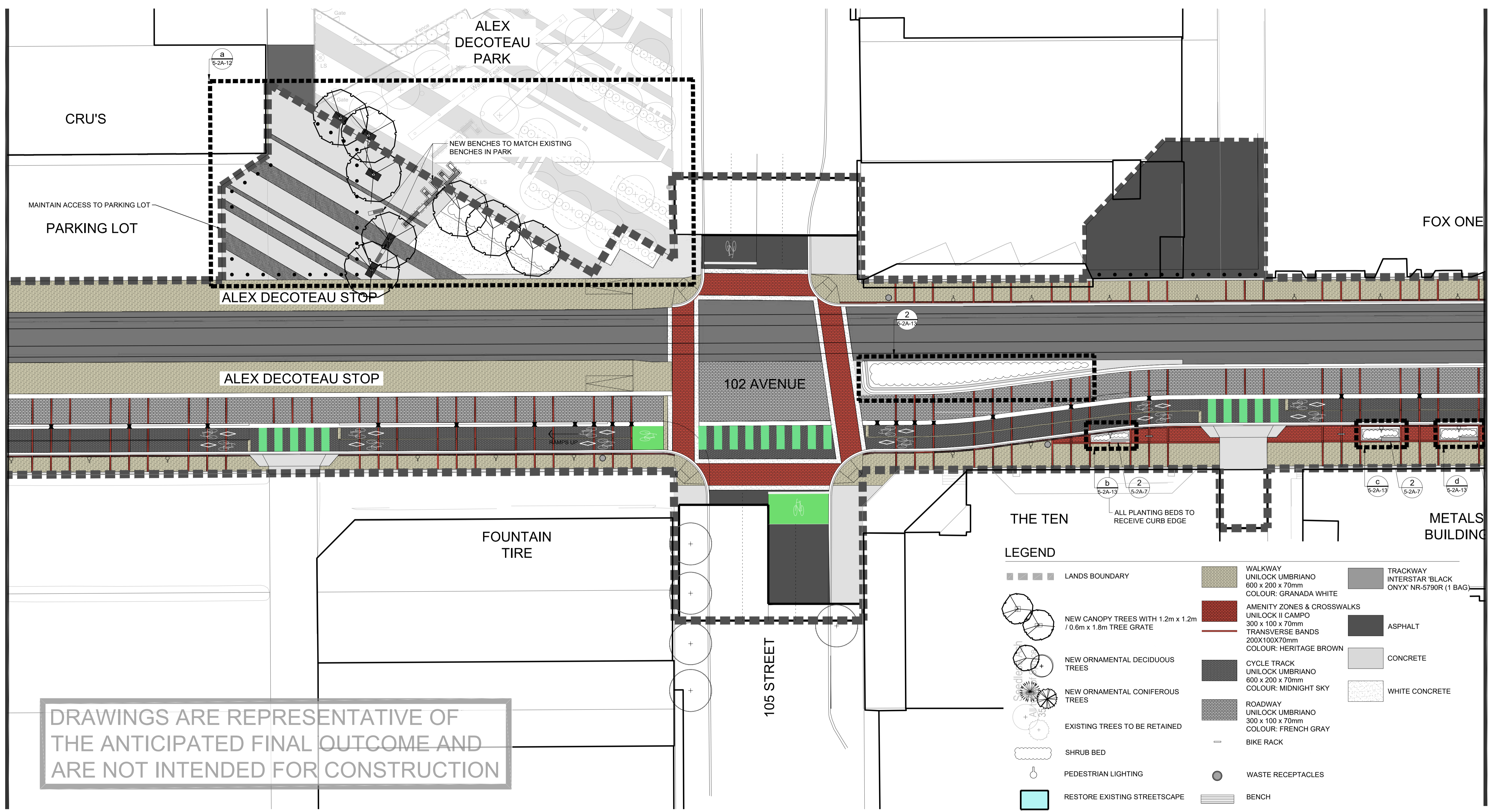

DRAWINGS ARE REPRESENTATIVE OF THE ANTICIPATED FINAL OUTCOME AND ARE NOT INTENDED FOR CONSTRUCTION

LEGEND

	LANDS BOUNDARY		WALKWAY UNILOCK UMBRIANO 600 x 200 x 70mm COLOUR: GRANADA WHITE		TRACKWAY INTERSTAR 'BLACK ONYX' NR-5790R (1 BAG)
	NEW CANOPY TREES WITH 1.2m x 1.2m / 0.6m x 1.8m TREE GRATE		AMENITY ZONES & CROSSWALKS UNILOCK II CAMPO 300 x 100 x 70mm TRANSVERSE BANDS 200X100X70mm COLOUR: HERITAGE BROWN		ASPHALT
	NEW ORNAMENTAL DECIDUOUS TREES		CYCLE TRACK UNILOCK UMBRIANO 600 x 200 x 70mm COLOUR: MIDNIGHT SKY		CONCRETE
	NEW ORNAMENTAL CONIFEROUS TREES		ROADWAY UNILOCK UMBRIANO 300 x 100 x 70mm COLOUR: FRENCH GRAY		WHITE CONCRETE
	EXISTING TREES TO BE RETAINED		BIKE RACK		
	SHRUB BED		WASTE RECEPTACLES		
	PEDESTRIAN LIGHTING		BENCH		
	RESTORE EXISTING STREETSCAPE		DECORATIVE BOLLARD		
	CYCLETRACK BOLLARD				
	CURB RAMPS SHOWN FOR ILLUSTRATION PURPOSES ONLY				

no.	description	date	checked
4	ISSUED FOR PA V4	18-9-2020	J.S.
3	ISSUED FOR PA V3	23-7-2020	J.S.
2	ISSUED FOR PA V2	3-7-2020	B.D.
1	ISSUED FOR PA V1R	14-2-2020	B.D.
	revisions		

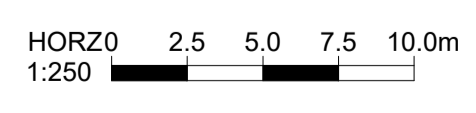

NOT FOR CONSTRUCTION

AECOM
Prime Consultant

Edmonton

HATCH

DIALOG

ISL Engineering and Land Services

M M
MOTT MACDONALD

LANDSCAPE
STREETSCAPE DESIGN
105 STREET & 102 AVENUE

DRAWING NO: 5-2A-4

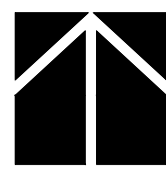

JOHNSON / September 14, 2020 / G:\PROJECTS\1400014854_VALLEY_LINE_LRT_WEST_DESIGN_OE02_CADD\20_DRAFTING\2020_LANDSCAPE\041_102_107 AND SPRING STREETS LAYOUT.DWG

MATCHLINE - REFER TO DRAWING 5-2A-4

MATCHLINE - REFER TO DRAWING 5-2A-6

VALLEY LINE WEST LRT

DRAWINGS ARE REPRESENTATIVE OF THE ANTICIPATED FINAL OUTCOME AND ARE NOT INTENDED FOR CONSTRUCTION

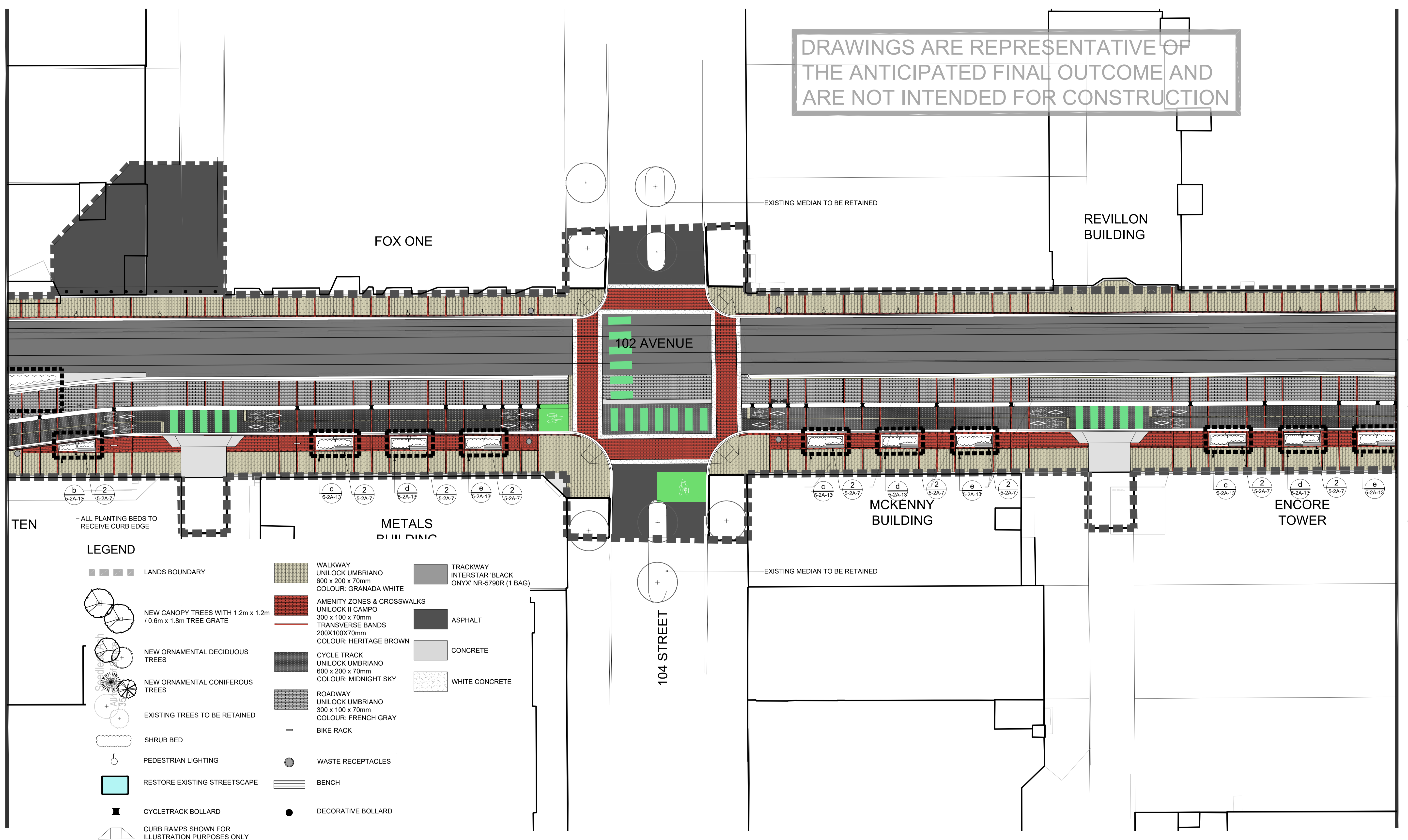

LEGEND

- LANDS BOUNDARY
- NEW CANOPY TREES WITH 1.2m x 1.2m / 0.6m x 1.8m TREE GRATE
- NEW ORNAMENTAL DECIDUOUS TREES
- NEW ORNAMENTAL CONIFEROUS TREES
- EXISTING TREES TO BE RETAINED
- SHRUB BED
- PEDESTRIAN LIGHTING
- RESTORE EXISTING STREETSCAPE
- CYCLETRACK BOLLARD
- CURB RAMPS SHOWN FOR ILLUSTRATION PURPOSES ONLY
- WALKWAY UNILOCK UMBRIANO 600 x 200 x 70mm COLOUR: GRANADA WHITE
- AMENITY ZONES & CROSSWALKS UNILOCK II CAMPO 300 x 100 x 70mm TRANSVERSE BANDS 200X100X70mm COLOUR: HERITAGE BROWN
- CYCLE TRACK UNILOCK UMBRIANO 600 x 200 x 70mm COLOUR: MIDNIGHT SKY
- ROADWAY UNILOCK UMBRIANO 300 x 100 x 70mm COLOUR: FRENCH GRAY
- BIKE RACK
- WASTE RECEPTACLES
- BENCH
- DECORATIVE BOLLARD
- TRACKWAY INTERSTAR 'BLACK ONYX' NR-5790R (1 BAG)
- ASPHALT
- CONCRETE
- WHITE CONCRETE

no.	description	date	checked
4	ISSUED FOR PA V4	18-9-2020	J.S.
3	ISSUED FOR PA V3	23-7-2020	J.S.
2	ISSUED FOR PA V2	3-7-2020	B.D.
1	ISSUED FOR PA V1R	14-2-2020	B.D.
	revisions		

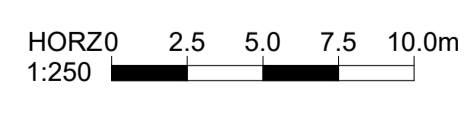

NOT FOR CONSTRUCTION



LANDSCAPE STREETScape DESIGN
104 STREET & 102 AVENUE
DRAWING NO: 5-2A-5

J:\JOHNSON\September 14, 2020\G:\PROJECTS\1400014854\VALLEY_LINE_LRT_WEST_DESIGN_0102_CADD\2020_DRAFTING\2020_LANDSCAPE\0411_102_107_AND_SPR\VALLEY_WEST_0411_102_107_AND_SPR_STREETSCAPE_LAYOUT.DWG

MATCHLINE - REFER TO DRAWING 5-2A-5

VALLEY LINE WEST LRT

DRAWINGS ARE REPRESENTATIVE OF THE ANTICIPATED FINAL OUTCOME AND ARE NOT INTENDED FOR CONSTRUCTION

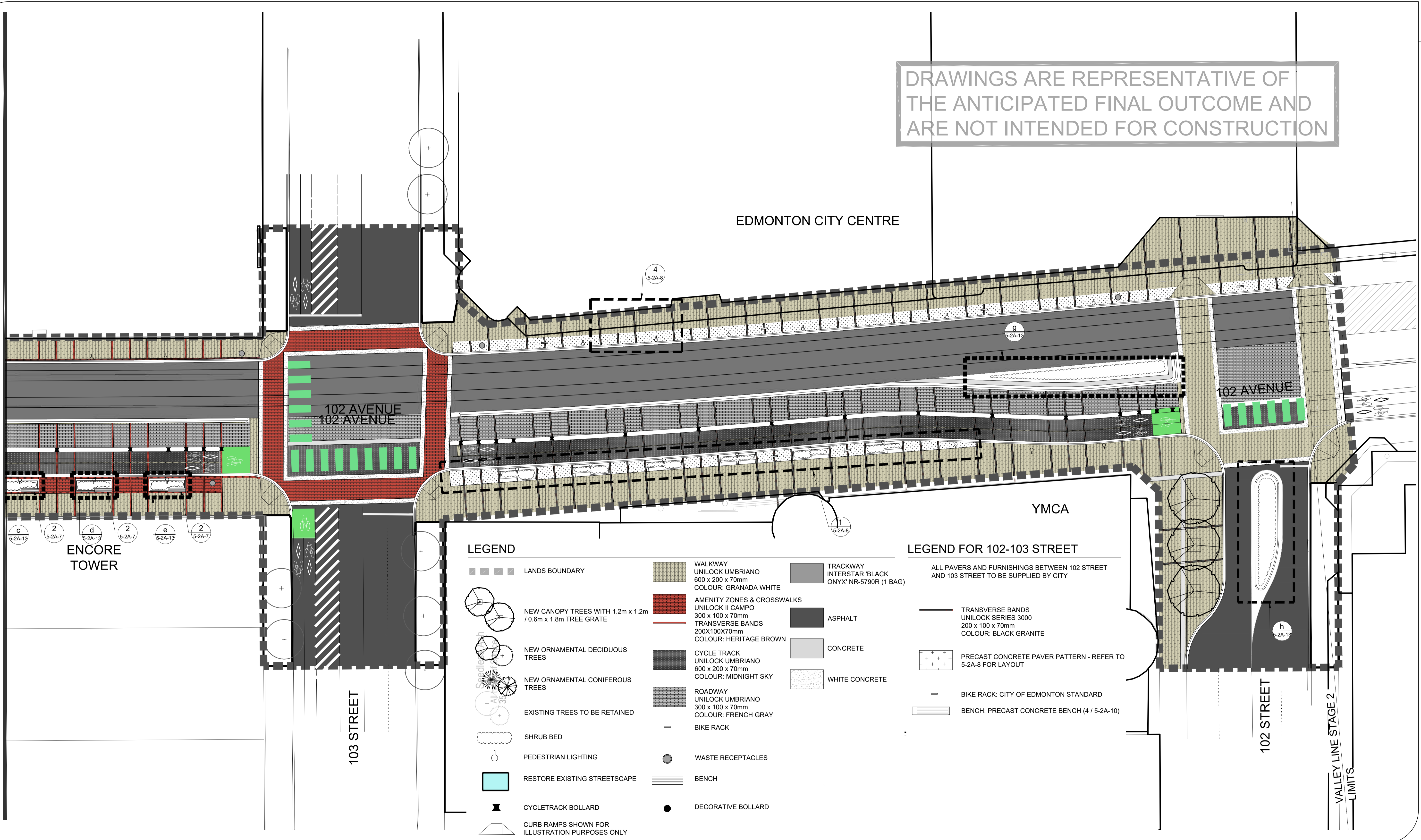

LEGEND

- LANDS BOUNDARY
- NEW CANOPY TREES WITH 1.2m x 1.2m / 0.6m x 1.8m TREE GRATE
- NEW ORNAMENTAL DECIDUOUS TREES
- NEW ORNAMENTAL CONIFEROUS TREES
- EXISTING TREES TO BE RETAINED
- SHRUB BED
- PEDESTRIAN LIGHTING
- RESTORE EXISTING STREETSCAPE
- CYCLETRACK BOLLARD
- CURB RAMPS SHOWN FOR ILLUSTRATION PURPOSES ONLY
- WALKWAY UNILOCK UMBRIANO 600 x 200 x 70mm COLOUR: GRANADA WHITE
- AMENITY ZONES & CROSSWALKS UNILOCK II CAMPO 300 x 100 x 70mm TRANSVERSE BANDS 200X100X70mm COLOUR: HERITAGE BROWN
- CYCLE TRACK UNILOCK UMBRIANO 600 x 200 x 70mm COLOUR: MIDNIGHT SKY
- ROADWAY UNILOCK UMBRIANO 300 x 100 x 70mm COLOUR: FRENCH GRAY
- BIKE RACK
- WASTE RECEPTACLES
- BENCH
- DECORATIVE BOLLARD
- TRACKWAY INTERSTAR 'BLACK ONYX' NR-5790R (1 BAG)
- ASPHALT
- CONCRETE
- WHITE CONCRETE

LEGEND FOR 102-103 STREET

- ALL PAVERS AND FURNISHINGS BETWEEN 102 STREET AND 103 STREET TO BE SUPPLIED BY CITY
- TRANSVERSE BANDS UNILOCK SERIES 3000 200 x 100 x 70mm COLOUR: BLACK GRANITE
- PRECAST CONCRETE PAVER PATTERN - REFER TO 5-2A-8 FOR LAYOUT
- BIKE RACK: CITY OF EDMONTON STANDARD
- BENCH: PRECAST CONCRETE BENCH (4 / 5-2A-10)

no.	description	date	checked
4	ISSUED FOR PA V4	18-9-2020	J.S.
3	ISSUED FOR PA V3	23-7-2020	J.S.
2	ISSUED FOR PA V2	3-7-2020	B.D.
1	ISSUED FOR PA V1R	14-2-2020	B.D.
revisions			

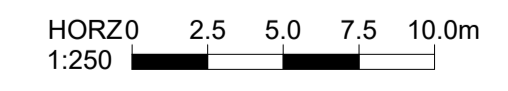

NOT FOR CONSTRUCTION



LANDSCAPE
STREETSCAPE DESIGN
102-103 STREET & 102 AVENUE
DRAWING NO: 5-2A-6

J:\JOHNSON\September 14, 2020\G:\PROJECTS\1400014854\VALLEY LINE_LRT_DESIGN_CADD\2020_DRAFTING\200_LANDSCAPE\0411_102_107 AND SPRING VALLEY WEST LRT_102_107 AND SPRING VALLEY WEST LRT_LAYOUT.DWG

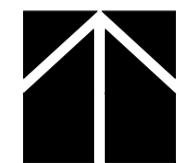
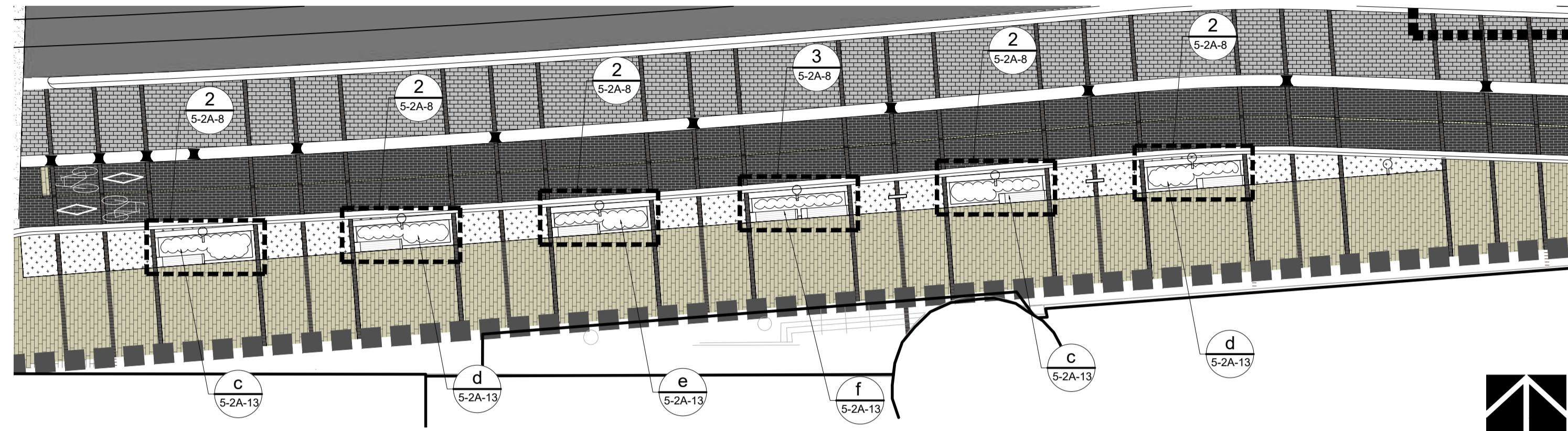

1 102-103 STREET AMENITY AREAS
5-2A-6

SCALE 1:200

DRAWINGS ARE REPRESENTATIVE OF THE ANTICIPATED FINAL OUTCOME AND ARE NOT INTENDED FOR CONSTRUCTION

PRECAST CONCRETE PAVER LEGEND (Applies to this sheet only)

- 600 x 200 x 100mm UMBRIANO MIDNIGHT SKY
- 600 x 200 x 70mm UMBRIANO MIDNIGHT SKY
- 600 x 200 x 70mm UMBRIANO FRENCH GREY
- 600 x 200 x 70mm UMBRIANO GRANADA WHITE
- 300 x 100 x 100mm UMBRIANO MIDNIGHT SKY
- 300 x 100 x 70mm UMBRIANO MIDNIGHT SKY
- 300 x 100 x 100mm UMBRIANO FRENCH GREY
- 300 x 100 x 70mm UMBRIANO FRENCH GREY
- 300 x 100 x 100mm UMBRIANO GRANADA WHITE
- 300 x 100 x 70mm UMBRIANO GRANADA WHITE
- 200 x 100 x 70mm SERIES 3000 BLACK GRANITE
- 300 x 100 x 100mm SERIES 3000 GLACIER

PAVERS BY UNILOCK

- LAFARGE ARTEVIA SLATES EXECUTIVE CONCRETE

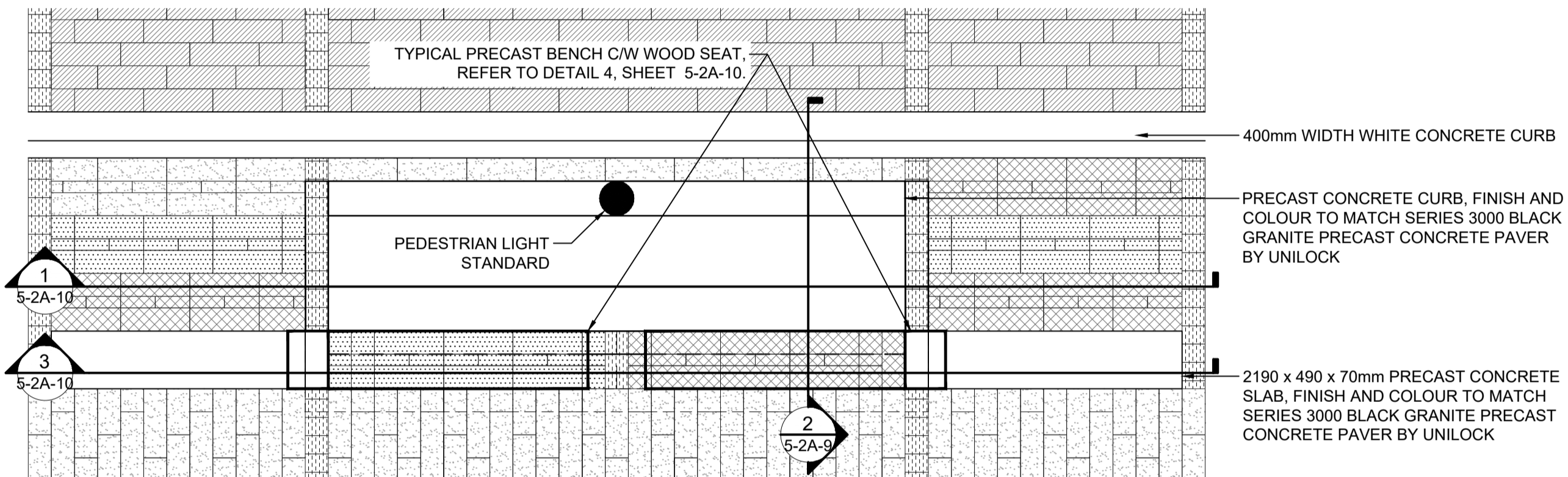

2 AMENITY AREA
5-2A-6

SCALE 1:40

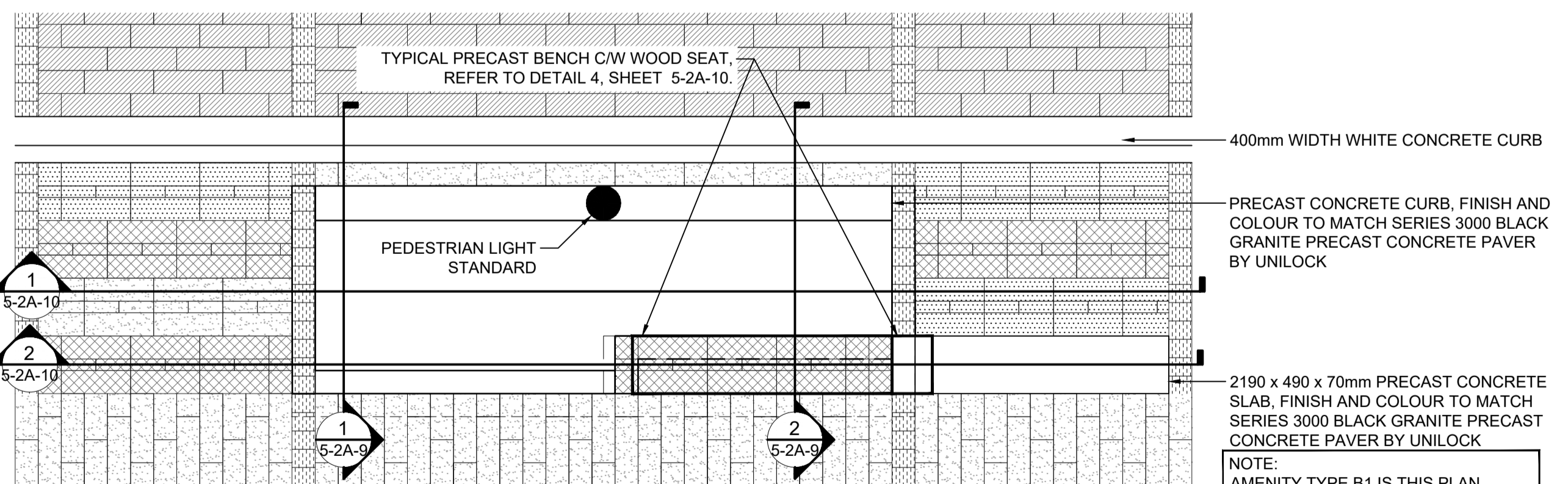

3 AMENITY B1 AREA
5-2A-6

SCALE 1:40

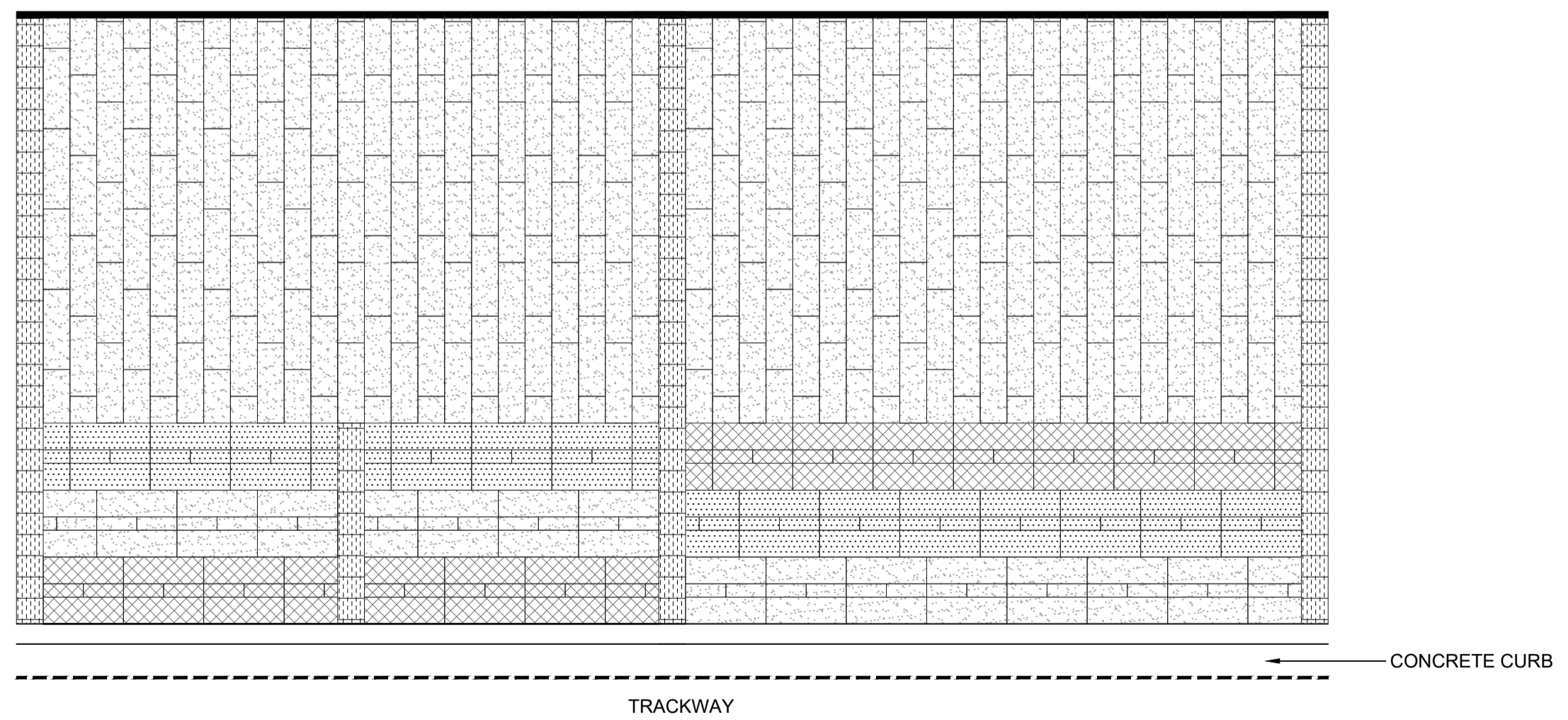

4 AMENITY AREA
5-2A-6

SCALE 1:40

no.	description	date	checked
4	ISSUED FOR PA V4	18-9-2020	J.S.
3	ISSUED FOR PA V3	23-7-2020	J.S.
2	ISSUED FOR PA V2	3-7-2020	B.D.
1	ISSUED FOR PA V1R	14-2-2020	B.D.
	revisions		

NOT FOR CONSTRUCTION



LANDSCAPE STREETScape DESIGN AMENITY AREA PLANS

DRAWING NO: 5-2A-8

VALLEY LINE WEST LRT

J:\JOHNSON\September 14, 2020\G:\PROJECTS\1400014854\VALLEY_LINE_LRT_WEST_DESIGN_0102_CADD\20_DRAFTING\200_LANDSCAPE\0411_102_107_AND_SPR\VALLEY-0411-102_107_AND_SPR-STREETSCAPE_LAYOUT.DWG

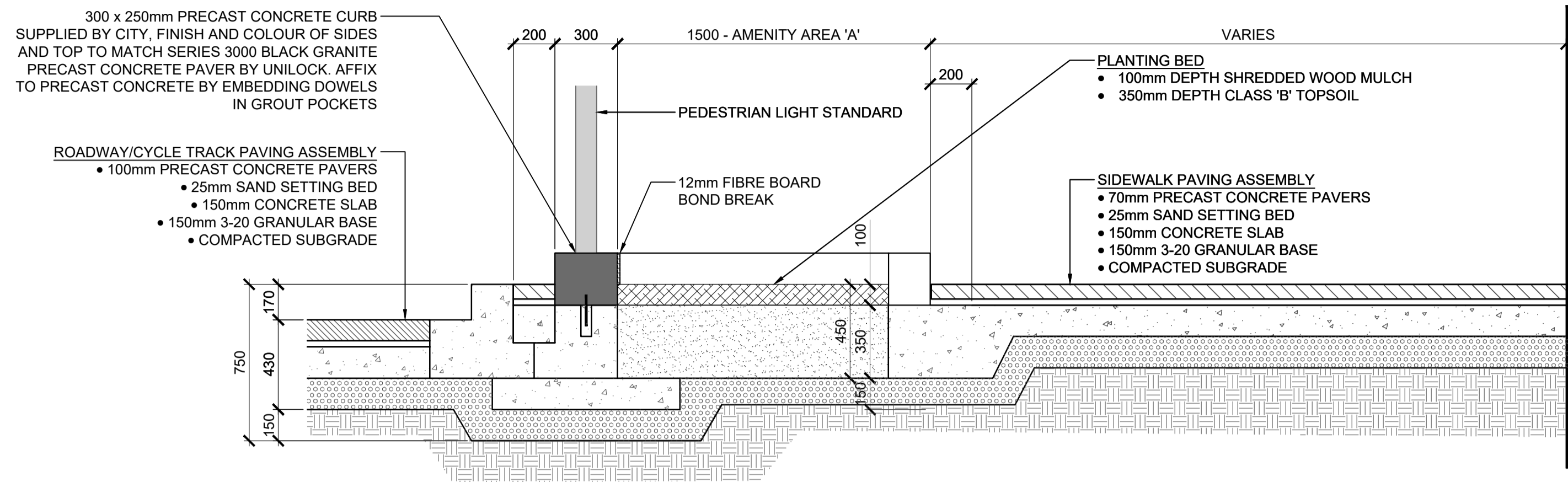

NOTE:
PRECAST CONCRETE CURB MAY BE
WIDENED LOCALLY TO
ACCOMMODATE PEDESTRIAN LIGHT

DRAWINGS ARE REPRESENTATIVE OF
THE ANTICIPATED FINAL OUTCOME AND
ARE NOT INTENDED FOR CONSTRUCTION

1 TYPICAL AMENITY SECTION TYPE A
5-2A-8 SCALE 1:40

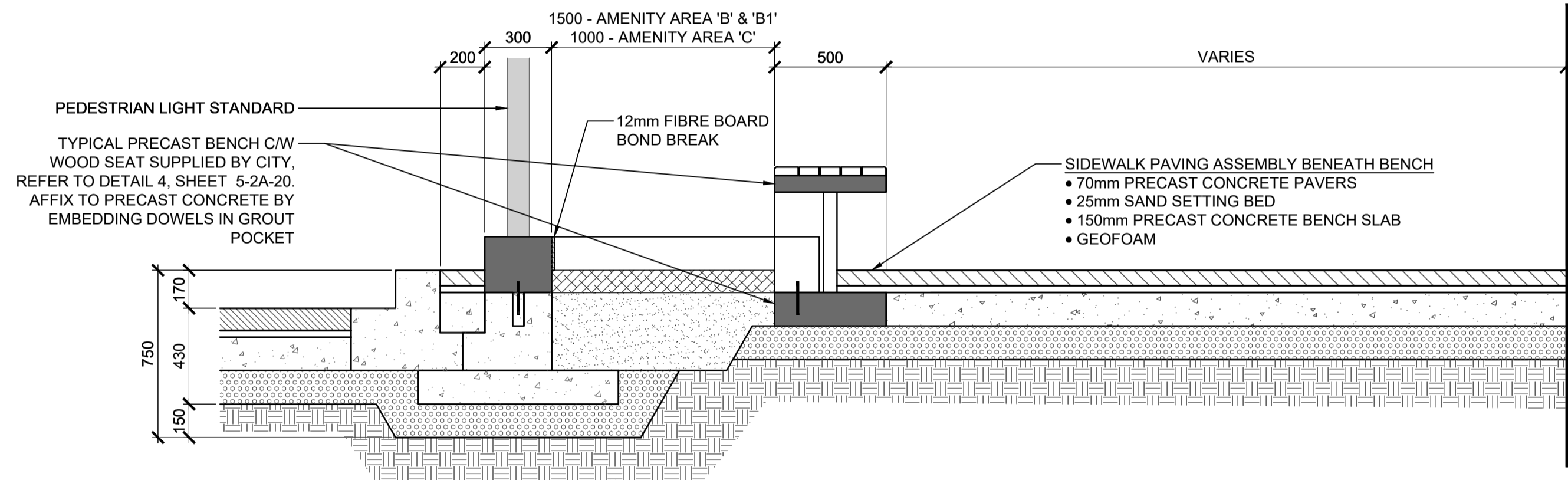

2 TYPICAL AMENITY SECTION WITH BENCH TYPE B, B1, AND C
5-2A-8 SCALE 1:40

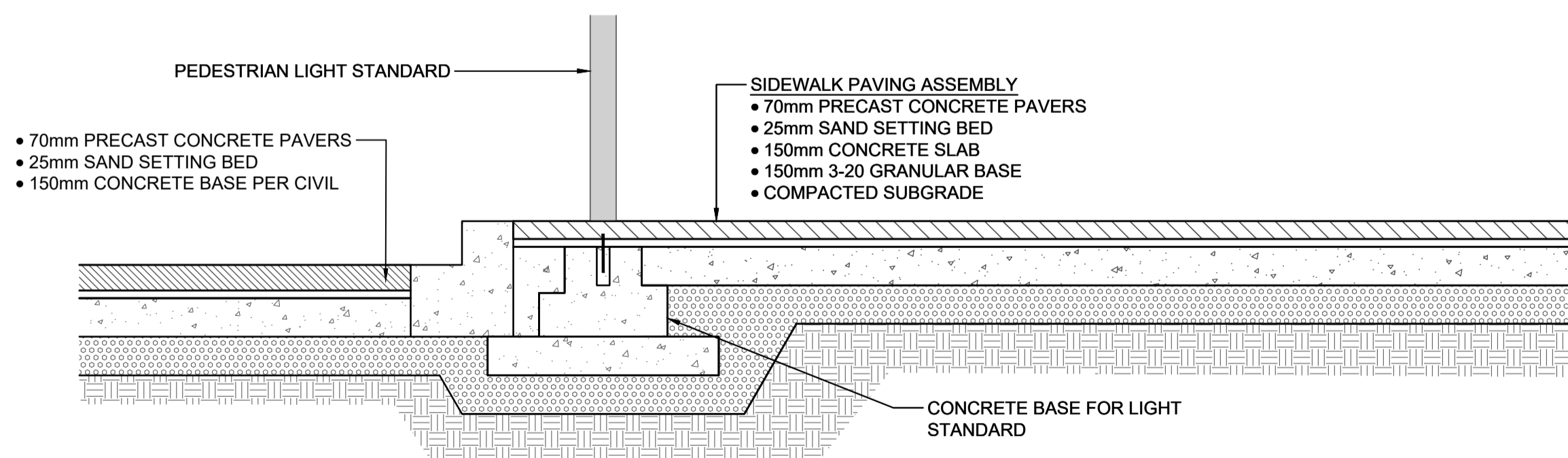

3 TYPICAL SECTION
5-2A-8 SCALE 1:40

VALLEY LINE WEST LRT

no.	description	date	checked
4	ISSUED FOR PA V4	18-9-2020	J.S.
3	ISSUED FOR PA V3	23-7-2020	J.S.
2	ISSUED FOR PA V2	3-7-2020	B.D.
1	ISSUED FOR PA V1R	14-2-2020	B.D.
	revisions		

NOT FOR
CONSTRUCTION

AECOM
Prime Consultant

camonton

HATCH

DIALOG

ISL Engineering and Land Services

M M
MOTT MACDONALD

LANDSCAPE
STREETSCAPE DESIGN
AMENITY AREA CROSS SECTIONS

DRAWING NO: 5-2A-9

J:\JOHNSON\September 14, 2020\G:\PROJECTS\1400014854\VALLEY_LINE_LRT_WEST_DESIGN_0102_CADD\20_DRAFTING\200_LANDSCAPE\0411_00_LOCAL_XREF\06_102_107 AND SPR\VALLEY LINE WEST LRT AND SPR STREETScape LAYOUT.DWG

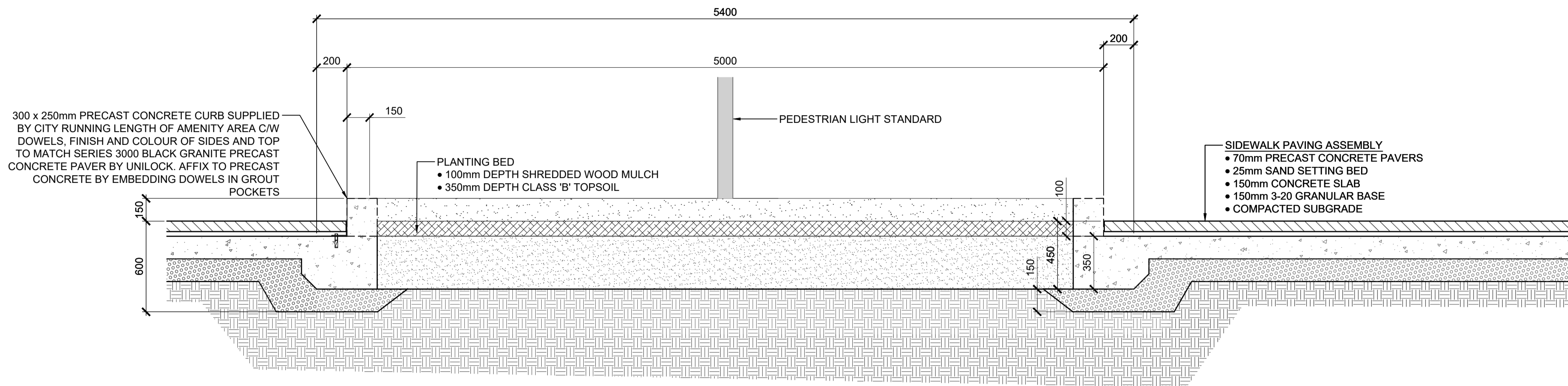

1 TYPICAL AMENITY LONGITUDINAL SECTION - A

5-2A-8

SCALE 1:40

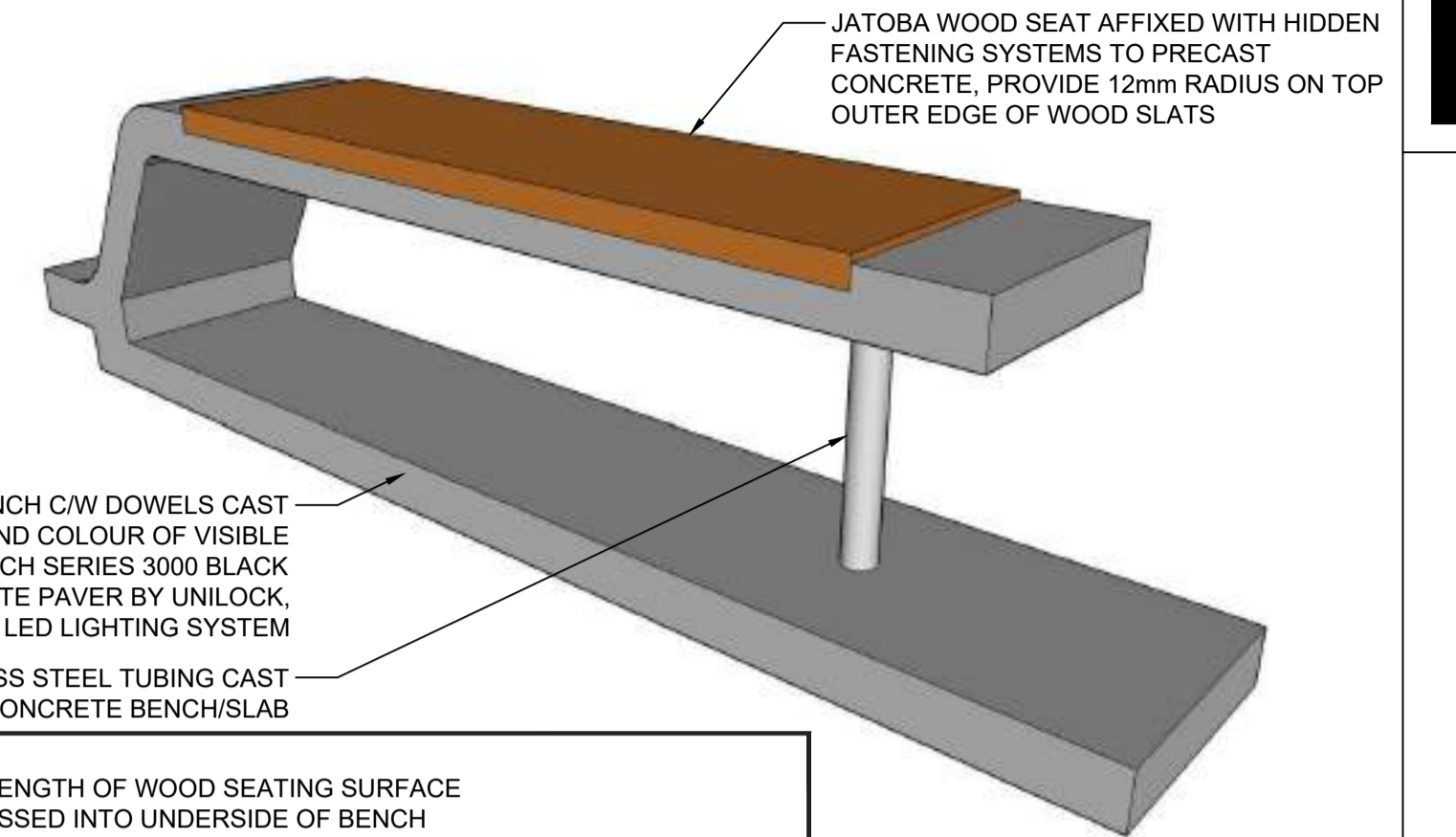

PRECAST CONCRETE BENCH C/W DOWELS CAST INTO UNDERSIDE. FINISH AND COLOUR OF VISIBLE CONCRETE TO MATCH SERIES 3000 BLACK GRANITE PRECAST CONCRETE PAVER BY UNILOCK. INCLUDE UNDERSEAT LED LIGHTING SYSTEM

- LED LIGHTING SYSTEM**
- LIGHT TO MATCH LENGTH OF WOOD SEATING SURFACE
 - LIGHT TO BE RECESSED INTO UNDERSIDE OF BENCH
 - JUNCTION BOX, BALLAST AND LIGHT UNIT TO BE HIDDEN FROM VIEW
 - FLEXIBLE LED CIRCUIT STRIP, FLEX II EXTERIOR BY ACCLAIM LIGHTING
 - ALUMINUM TRACKS TO HOUSE LED STRIP, FLEX CHANNEL BY ACCLAIM LIGHTING
 - POWER SUPPLY UNIT, APS-60-12 BY ACCLAIM LIGHTING

4 TYPICAL PRECAST BENCH SUPPLIED BY CITY

N.T.S.

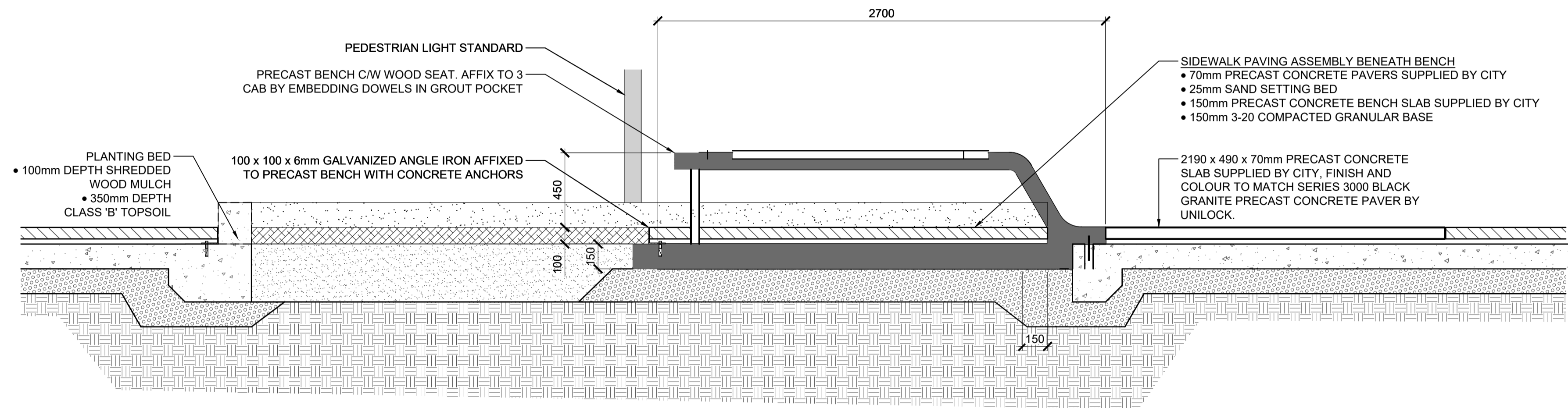

2 PLANTING BED SECTION WITH BENCH - B & B1

5-2A-8

SCALE 1:40

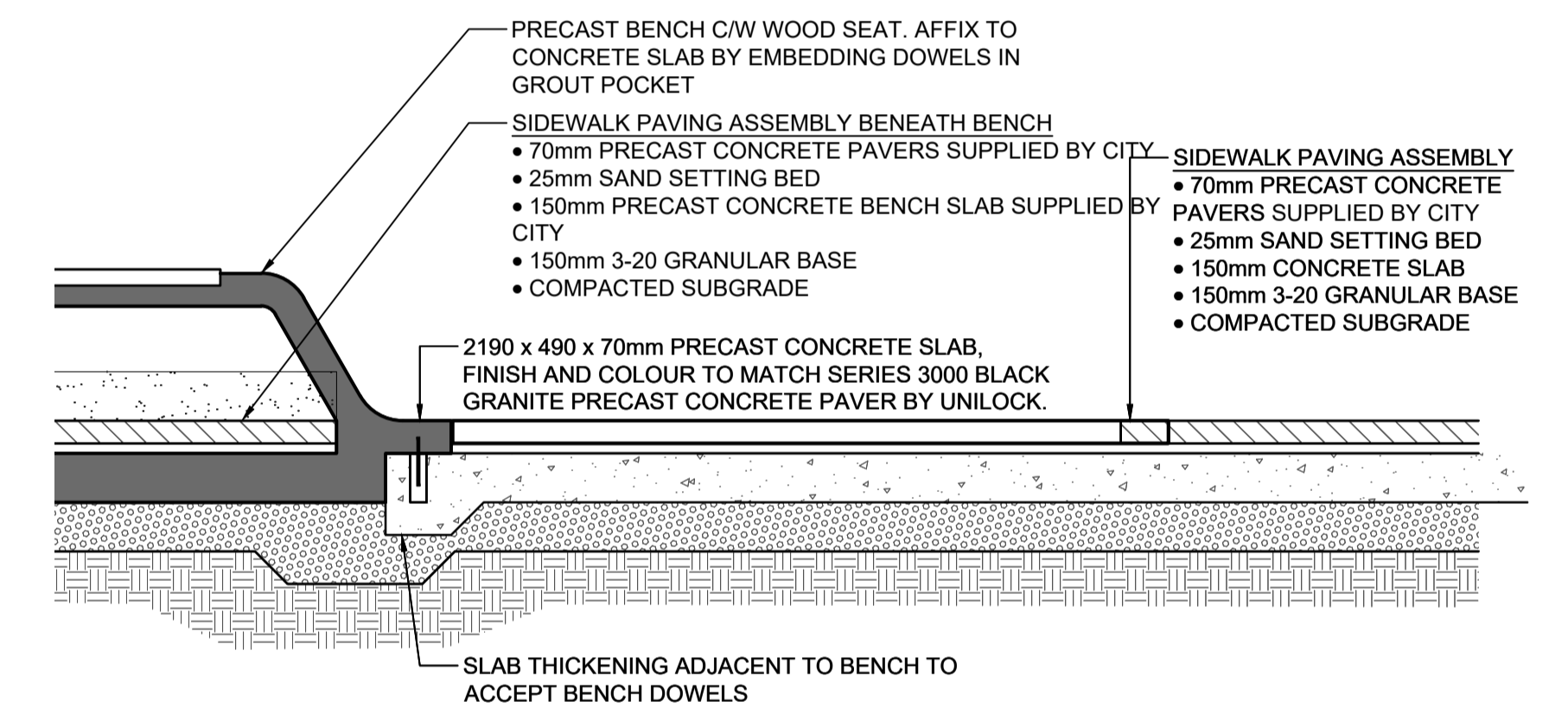

5 TYPICAL PRECAST BENCH MOUNTING ON GRADE

SCALE 1:40

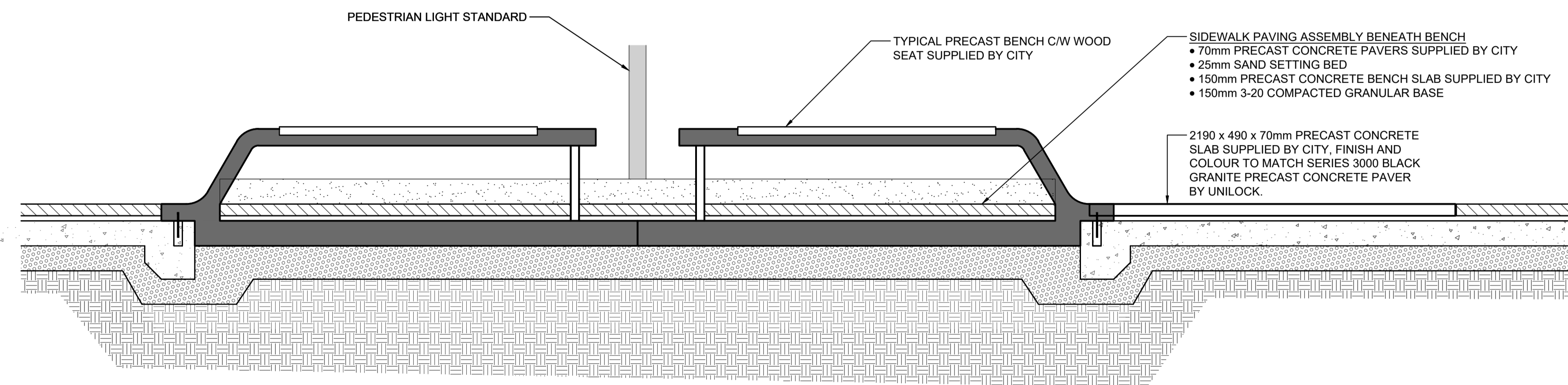

3 BENCH AND PAVING SECTION - C

5-2A-8

SCALE 1:40

DRAWINGS ARE REPRESENTATIVE OF THE ANTICIPATED FINAL OUTCOME AND ARE NOT INTENDED FOR CONSTRUCTION

no.	description	date	checked
4	ISSUED FOR PA V4	18-9-2020	J.S.
3	ISSUED FOR PA V3	23-7-2020	J.S.
2	ISSUED FOR PA V2	3-7-2020	B.D.
1	ISSUED FOR PA V1R	14-2-2020	B.D.
	revisions		

NOT FOR
CONSTRUCTION

AECOM
Prime Consultant

comonton

HATCH
DIALOG

ISL Engineering
and Land Services
M M
MOTT
MACDONALD

LANDSCAPE
STREETSCAPE DESIGN
AMENITY AREA LONGITUDINAL SECTIONS

DRAWING NO: 5-2A-10

VALLEY LINE WEST LRT

J:\JOHNSON\September 15, 2020\G:\PROJECTS\140001480014854 VALLEY LINE LRT WEST DESIGN_CADD\20_DRAFTING\2300_LANDSCAPE\0411_02_107 AND SPR PLANTING LAYOUT.DWG

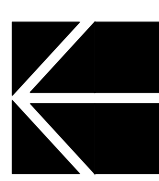

PLANT SCHEDULE 102-107 AVE

SHRUB AREAS	CODE	BOTANICAL NAME	COMMON NAME
	Bc	Bergenia cordifolia	Elephant Ears
	Ts	Tradescantia sp.	Spiderwort
	Ca	Calamagrostis acutiflora	Karl Foerster
	Dc	Deschampsia cespitosa	Tufted Hair Grass
	Fg	Festuca glauca	Blue Fescue
	Hs	Helictotrichon sempervirens	Blue Oat Grass
	Ho	Hemerocallis x 'Stella de Oro'	Stella de Oro Daylily
	Cm	Convallaria majalis	Lily-Of-The-Valley
	Is	Iris sibirica	Siberian Iris Cultivars
	Ss	Sedum spectabile 'Autumn Fire'	Showy Stonecrop
	Pa	Phalaris arundinacea	Variagated Ribbon Grass
	Ad	Aruncus dioicus	Goatsbeard Cultivars
	La	Leymus arenarius	Lyme Grass
		Turf	
		Lands Boundary	

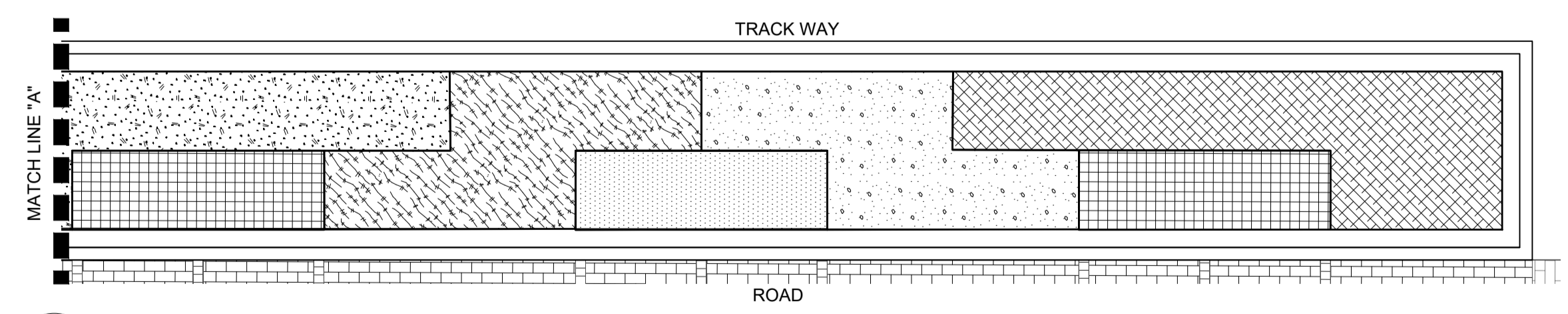
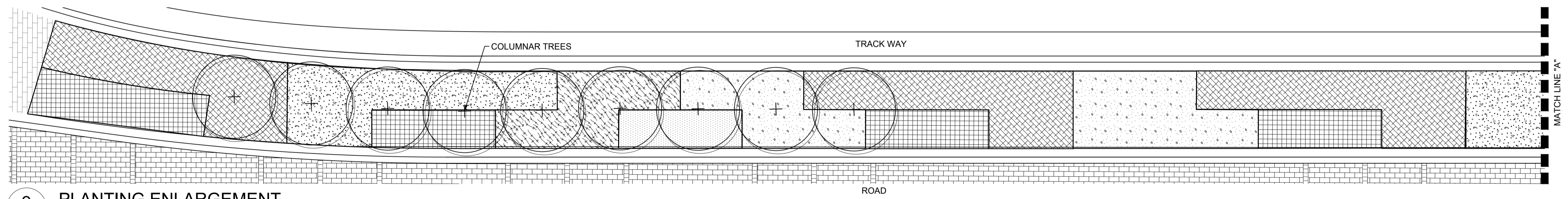
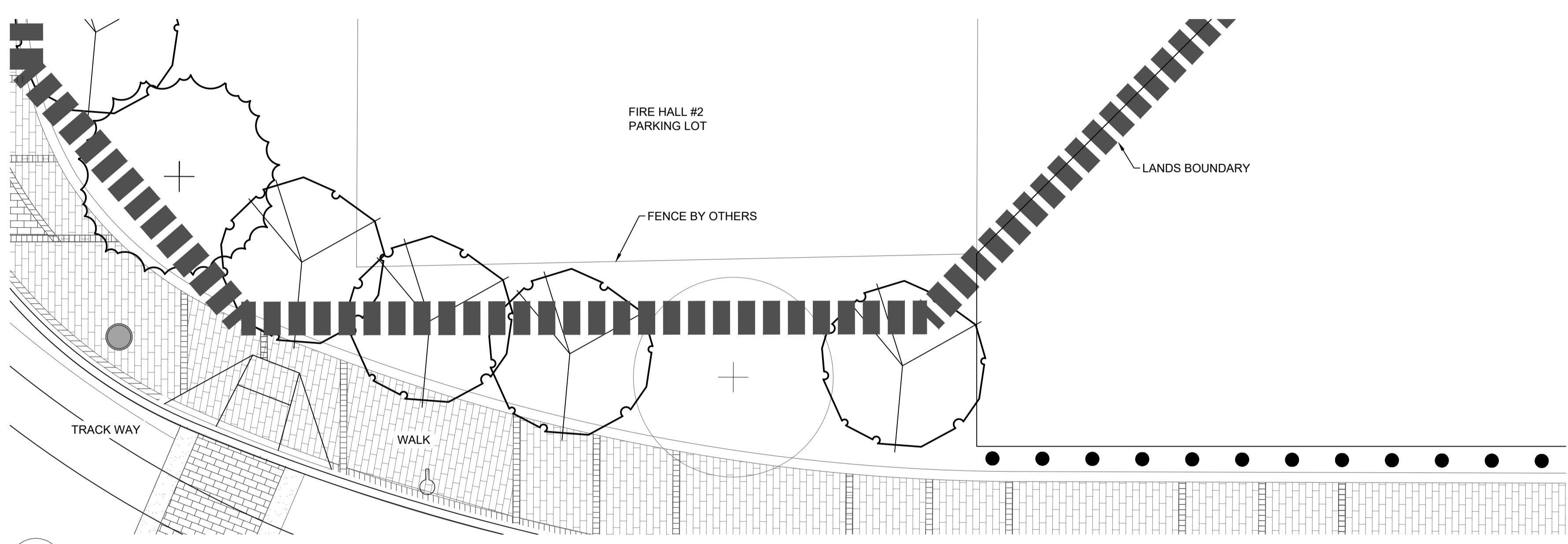
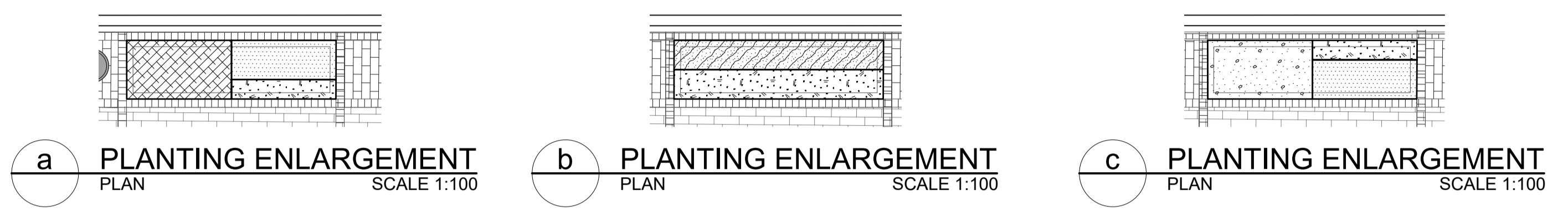

DRAWINGS ARE REPRESENTATIVE OF THE ANTICIPATED FINAL OUTCOME AND ARE NOT INTENDED FOR CONSTRUCTION

no.	description	date	checked
4	ISSUED FOR PA V4	18-9-2020	J.S.
3	ISSUED FOR PA V3	23-7-2020	J.S.
2	ISSUED FOR PA V2	3-7-2020	B.D.
1	ISSUED FOR PA V1R	14-2-2020	B.D.
	revisions		

NOT FOR CONSTRUCTION

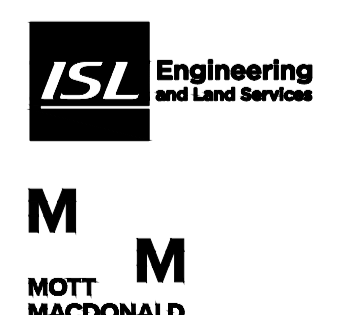

LANDSCAPE
STREETSCAPE DESIGN
107 STREET

DRAWING NO: 5-2A-11

VALLEY LINE WEST LRT

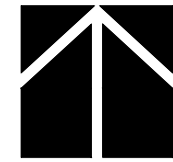

J.JOHNSON / September 15, 2020 / G:\PROJECTS\140001480014854_VALLEY_LINE_LRT_WEST_DESIGN_CHE02_CADD\20_DRAFTING\200_LANDSCAPE\0411_02_107 AND SPR PLANTING LAYOUT.DWG

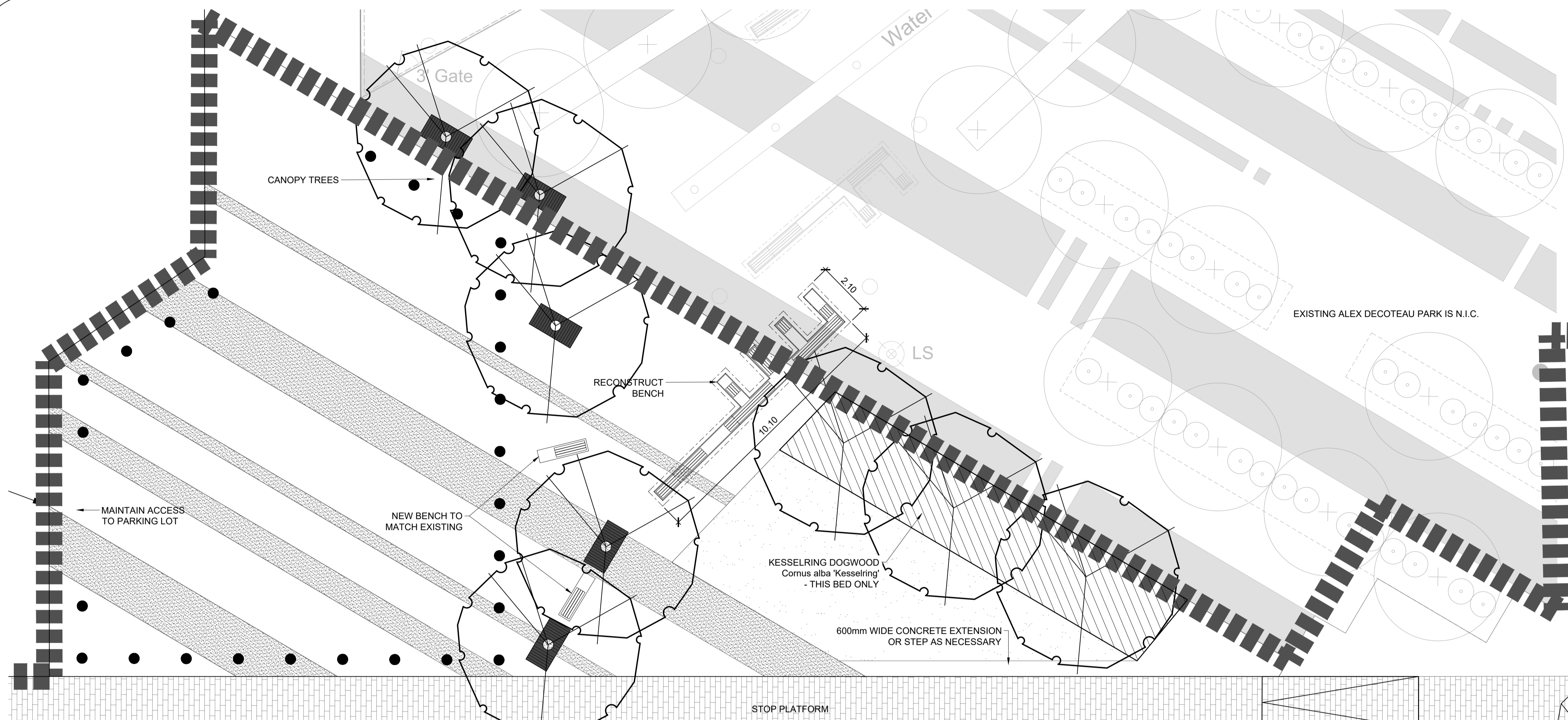

PLANT SCHEDULE 102-107 AVE

SHRUB AREAS	CODE	BOTANICAL NAME	COMMON NAME
	Bc	Bergenia cordifolia	Elephant Ears
	Ts	Tradescantia sp.	Spiderwort
	Ca	Calamagrostis acutiflora	Karl Foerster
	Dc	Deschampsia cespitosa	Tufted Hair Grass
	Fg	Festuca glauca	Blue Fescue
	Hs	Helictotrichon sempervirens	Blue Oat Grass
	Ho	Hemerocallis x 'Stella de Oro'	Stella de Oro Daylily
	Cm	Convallaria majalis	Lily-Of-The-Valley
	Is	Iris sibirica	Siberian Iris Cultivars
	Ss	Sedum spectabile 'Autumn Fire'	Showy Stonecrop
	Pa	Phalaris arundinacea	Variiegated Ribbon Grass
	Ad	Aruncus dioicus	Goatsbeard Cultivars
	La	Leymus arenarius	Lyme Grass
	Turf		
			Lands Boundary

a ALEX DECOTEAU PARK
PLAN

SCALE 1:100

DRAWINGS ARE REPRESENTATIVE OF THE ANTICIPATED FINAL OUTCOME AND ARE NOT INTENDED FOR CONSTRUCTION

VALLEY LINE WEST LRT

no.	description	date	checked
4	ISSUED FOR PA V4	18-9-2020	J.S.
3	ISSUED FOR PA V3	23-7-2020	J.S.
2	ISSUED FOR PA V2	3-7-2020	B.D.
1	ISSUED FOR PA V1R	14-2-2020	B.D.
	revisions		

NOT FOR CONSTRUCTION

NOT FOR CONSTRUCTION

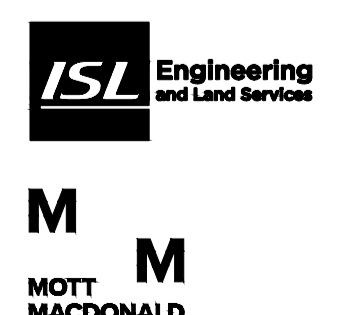

LANDSCAPE
STREETSCAPE DESIGN
102 AVENUE

DRAWING NO: 5-2A-12

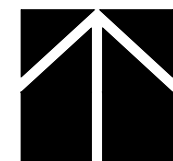

J:\JOHNSON\September 15, 2020\G:\PROJECTS\140001480014854_VALLEY_LINE_LRT_WEST_DESIGN_CAD\20_DRAFTING\2300_LANDSCAPE\0411_02_107 AND SPRV LAYOUT.DWG

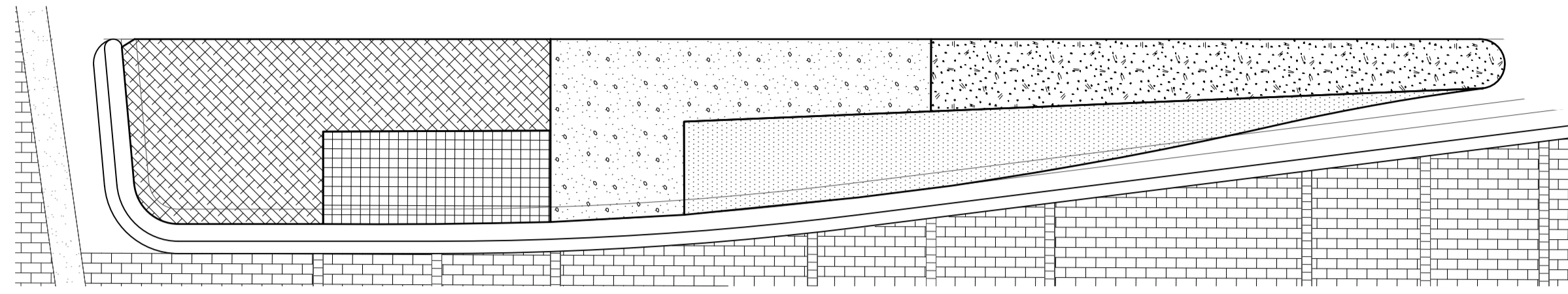

a PLANTING ENLARGEMENT
PLAN SCALE 1:100

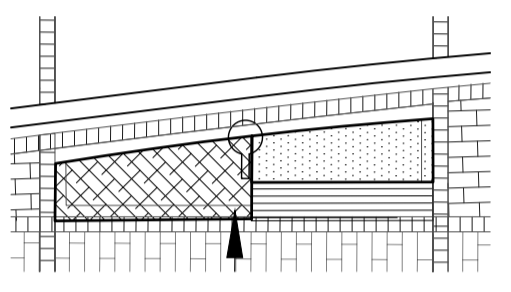

b PLANTING ENLARGEMENT
PLAN SCALE 1:100

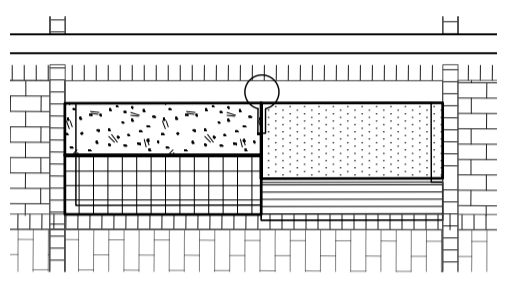

c PLANTING ENLARGEMENT
PLAN SCALE 1:100

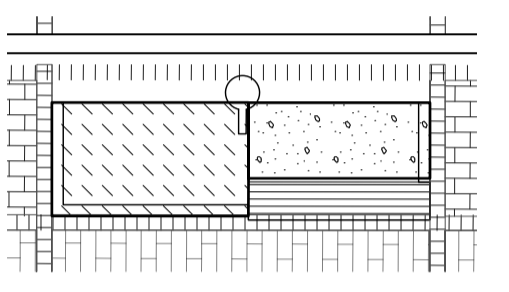

d PLANTING ENLARGEMENT
PLAN SCALE 1:100

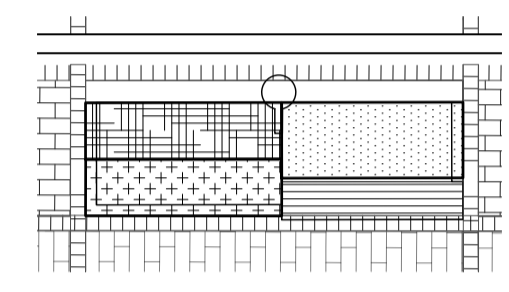

e PLANTING ENLARGEMENT
PLAN SCALE 1:100

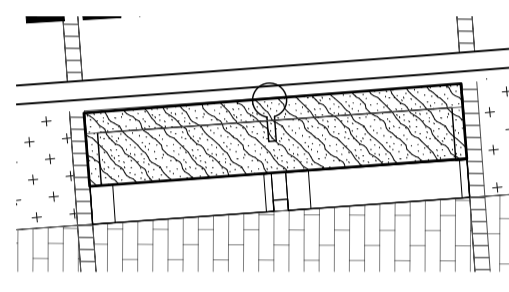

f PLANTING ENLARGEMENT
PLAN SCALE 1:100

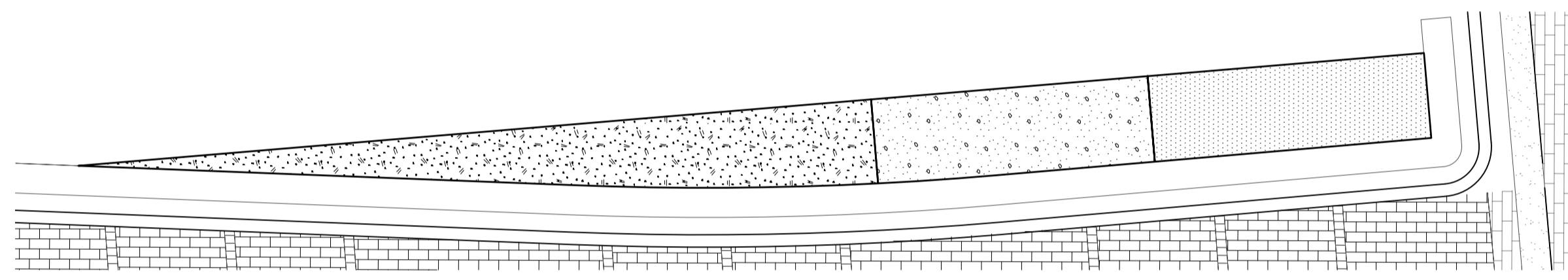

g PLANTING ENLARGEMENT
PLAN SCALE 1:100

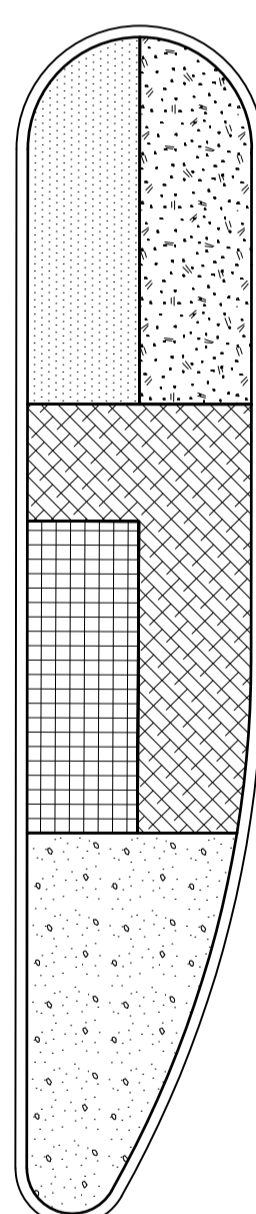

h PLANTING ENLARGEMENT
PLAN SCALE 1:100

PLANT SCHEDULE 102-107 AVE

SHRUB AREAS	CODE	BOTANICAL NAME	COMMON NAME
	Bc	Bergenia cordifolia	Elephant Ears
	Ts	Tradescantia sp.	Spiderwort
	Ca	Calamagrostis acutiflora	Karl Foerster
	Dc	Deschampsia cespitosa	Tufted Hair Grass
	Fg	Festuca glauca	Blue Fescue
	Hs	Helictotrichon sempervirens	Blue Oat Grass
	Ho	Hemerocallis x 'Stella de Oro'	Stella de Oro Daylily
	Cm	Convallaria majalis	Lily-Of-The-Valley
	Is	Iris sibirica	Siberian Iris Cultivars
	Ss	Sedum spectabile 'Autumn Fire'	Showy Stonecrop
	Pa	Phalaris arundinacea	Variiegated Ribbon Grass
	Ad	Aruncus dioicus	Goatsbeard Cultivars
	La	Leymus arenarius	Lyme Grass
	Turf		
	Lands Boundary		

DRAWINGS ARE REPRESENTATIVE OF THE ANTICIPATED FINAL OUTCOME AND ARE NOT INTENDED FOR CONSTRUCTION

no.	description	date	checked
4	ISSUED FOR PA V4	18-9-2020	J.S.
3	ISSUED FOR PA V3	23-7-2020	J.S.
2	ISSUED FOR PA V2	3-7-2020	B.D.
1	ISSUED FOR PA V1R	14-2-2020	B.D.
	revisions		

NOT FOR CONSTRUCTION

NOT FOR CONSTRUCTION



LANDSCAPE
STREETSCAPE DESIGN
102 AVENUE
DRAWING NO: 5-2A-13

VALLEY LINE WEST LRT

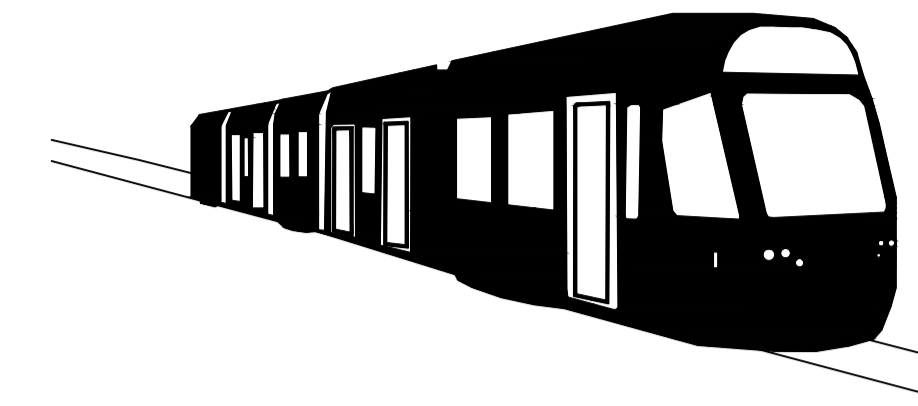

LEWIS FARMS TO DOWNTOWN

VALLEY LINE WEST LRT

JASPER PLACE OPPORTUNITY AREA STREETScape

APPENDIX 5-2B
SEPTEMBER 18, 2020

THE CITY OF EDMONTON APPROVALS	SIGNATURE	DATE

DRAWING LIST		
SHEET	DESCRIPTION	DRAWING NUMBER
1	COVER SHEET	5-2B-0
2	100 AVENUE & 156 STREET	5-2B-1
3	STONY PLAIN ROAD & 156 STREET	5-2B-2
4	STONY PLAIN ROAD & 156-155 STREET	5-2B-3
5	STONY PLAIN ROAD & 155-154 STREET	5-2B-4
6	STONY PLAIN ROAD & 154-153 STREET	5-2B-5
7	STONY PLAIN ROAD & 153-152 STREET	5-2B-6
8	STONY PLAIN ROAD & 152-151 STREET	5-2B-7
9	STONY PLAIN ROAD & 151-150 STREET	5-2B-8
10	STONY PLAIN ROAD & 150-149 STREET	5-2B-9
11	STONY PLAIN ROAD & 149-148 STREET	5-2B-10
12	FURNISHING ENLARGEMENT	5-2B-11

DRAWING LIST		
SHEET	DESCRIPTION	DRAWING NUMBER
13	156 STREET	5-2B-12
14	156 STREET	5-2B-13
15	STONY PLAIN ROAD & 156 STREET	5-2B-14
16	STONY PLAIN ROAD & 156 STREET	5-2B-15
17	STONY PLAIN ROAD	5-2B-16
18	STONY PLAIN ROAD	5-2B-17
19	STONY PLAIN ROAD	5-2B-18



Prime Consultant

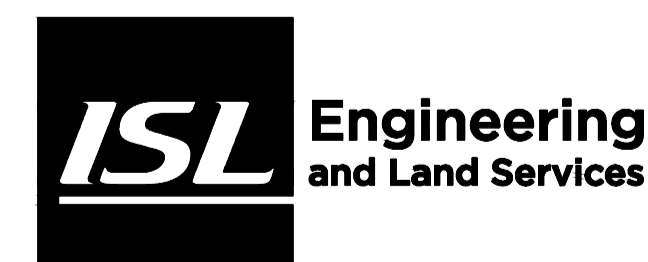

Associate Consultants

J:\JOHNSON\September 14, 2020\G:\PROJECTS\1400014854_VALLEY_LINE_LRT_WEST_DESIGN_CIE\02_CADD\00_DRAFTING\2200_LANDSCAPE\0411_102_107_AND_SPPRV\WDB-0411_102_107_AND_SPPR-STREETSCAPE_LAYOUT.DWG

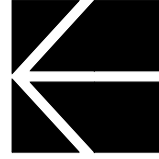

MATCHLINE - REFER TO DRAWING 5-2B-2

VALLEY LINE WEST LRT

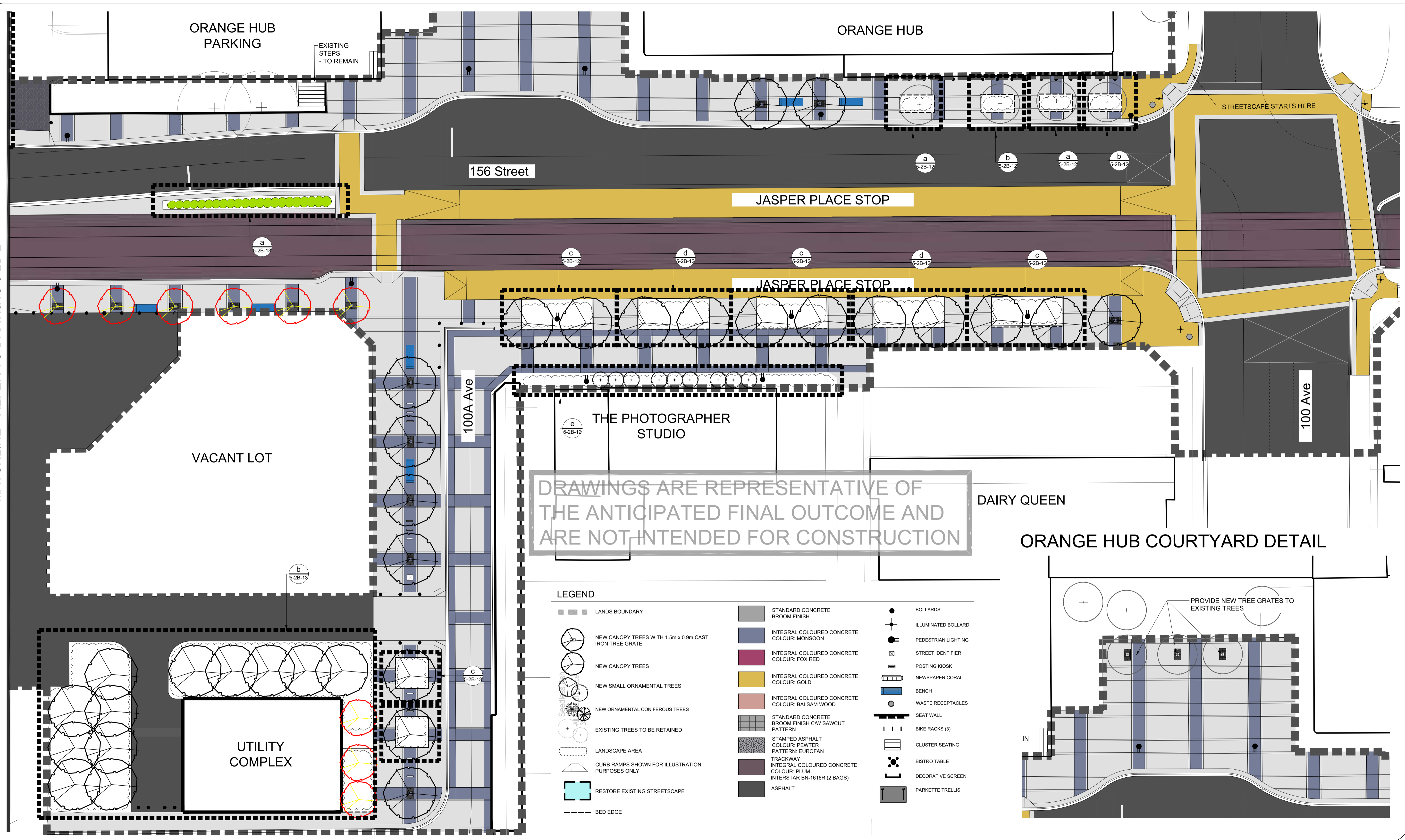

DRAWINGS ARE REPRESENTATIVE OF THE ANTICIPATED FINAL OUTCOME AND ARE NOT INTENDED FOR CONSTRUCTION

LEGEND

- LANDS BOUNDARY
- NEW CANOPY TREES WITH 1.5m x 0.9m CAST IRON TREE GRATE
- NEW CANOPY TREES
- NEW SMALL ORNAMENTAL TREES
- NEW ORNAMENTAL CONIFEROUS TREES
- EXISTING TREES TO BE RETAINED
- LANDSCAPE AREA
- CURB RAMPS SHOWN FOR ILLUSTRATION PURPOSES ONLY
- RESTORE EXISTING STREETSCAPE
- BED EDGE
- STANDARD CONCRETE BROOM FINISH
- INTEGRAL COLOURED CONCRETE COLOUR: MONSOON
- INTEGRAL COLOURED CONCRETE COLOUR: FOX RED
- INTEGRAL COLOURED CONCRETE COLOUR: GOLD
- INTEGRAL COLOURED CONCRETE COLOUR: BAL SAM WOOD
- STANDARD CONCRETE BROOM FINISH CW SAWCUT PATTERN
- STAMPED ASPHALT COLOUR: FEWTER PATTERN: EUROFAN
- TRACKWAY INTEGRAL COLOURED CONCRETE COLOUR: PLUM INTERSTAR BN-1616R (2 BAGS)
- ASPHALT
- BOLLARDS
- ILLUMINATED BOLLARD
- PEDESTRIAN LIGHTING
- STREET IDENTIFIER
- POSTING KIOSK
- NEWSPAPER CORAL
- BENCH
- WASTE RECEPTACLES
- SEAT WALL
- BIKE RACKS (3)
- CLUSTER SEATING
- BISTRO TABLE
- DECORATIVE SCREEN
- PARKETTE TRELLIS

ORANGE HUB COURTYARD DETAIL

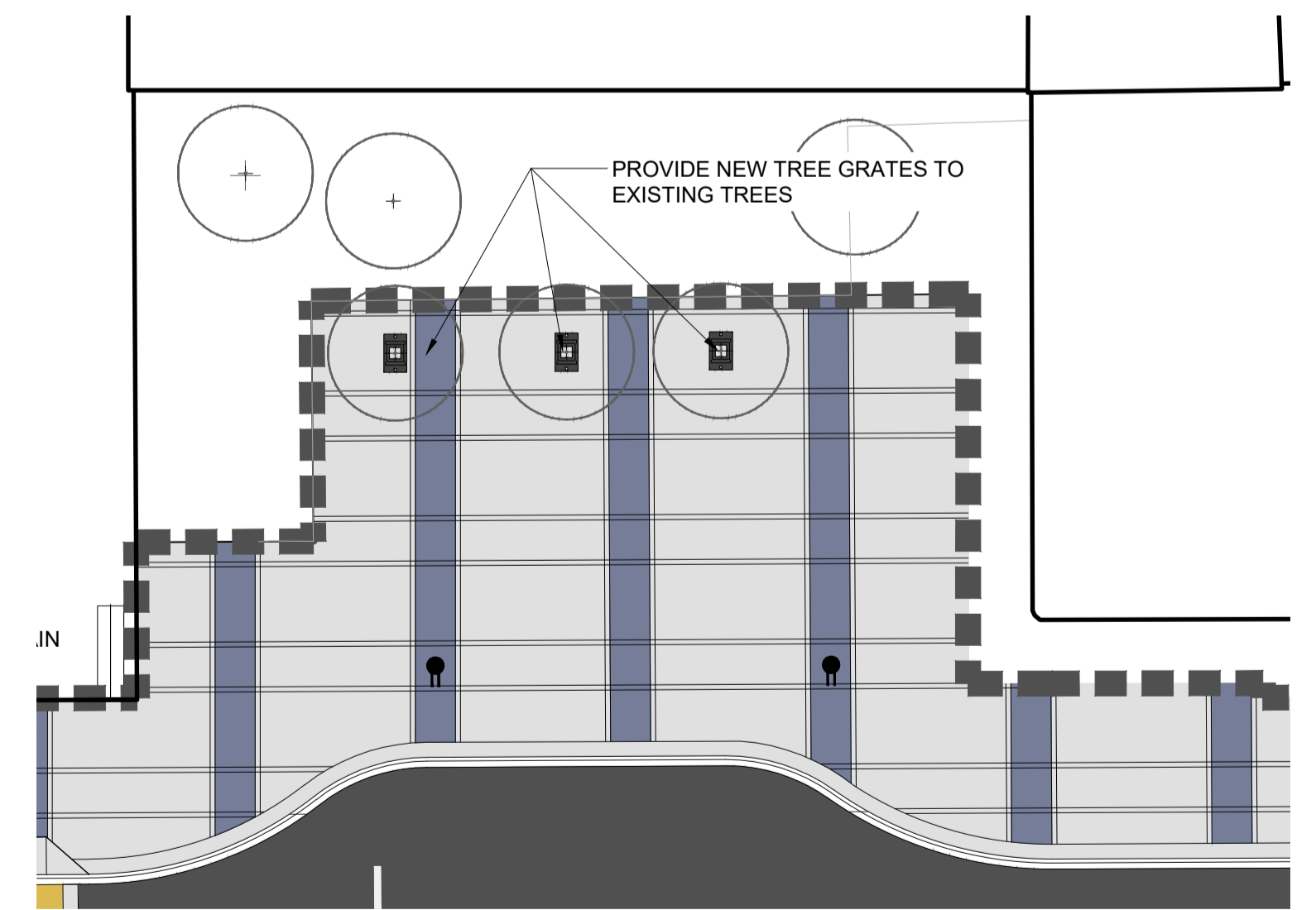

no.	description	date	checked
3	ISSUED FOR PA V4	18-9-2020	J.S.
2	ISSUED FOR PA V3	23-7-2020	J.S.
1	ISSUED FOR PA V1R	14-2-2020	B.D.
	revisions		



NOT FOR CONSTRUCTION



LANDSCAPE STREETSCAPE DESIGN
100 AVENUE & 156 STREET

DRAWING NO: 5-2B-1

J:\JOHNSON\September 14, 2020\G:\PROJECTS\1400014854_VALLEY_LINE_LRT_WEST_DESIGN_CIE02_CADD\20_DRAFTING\2200_LANDSCAPE\0411_00_LOCAL_XREF\06_102_107_AND_SPPRV\WB-0411_102_107_AND_SPPR-STREETSCAPE_LAYOUT.DWG

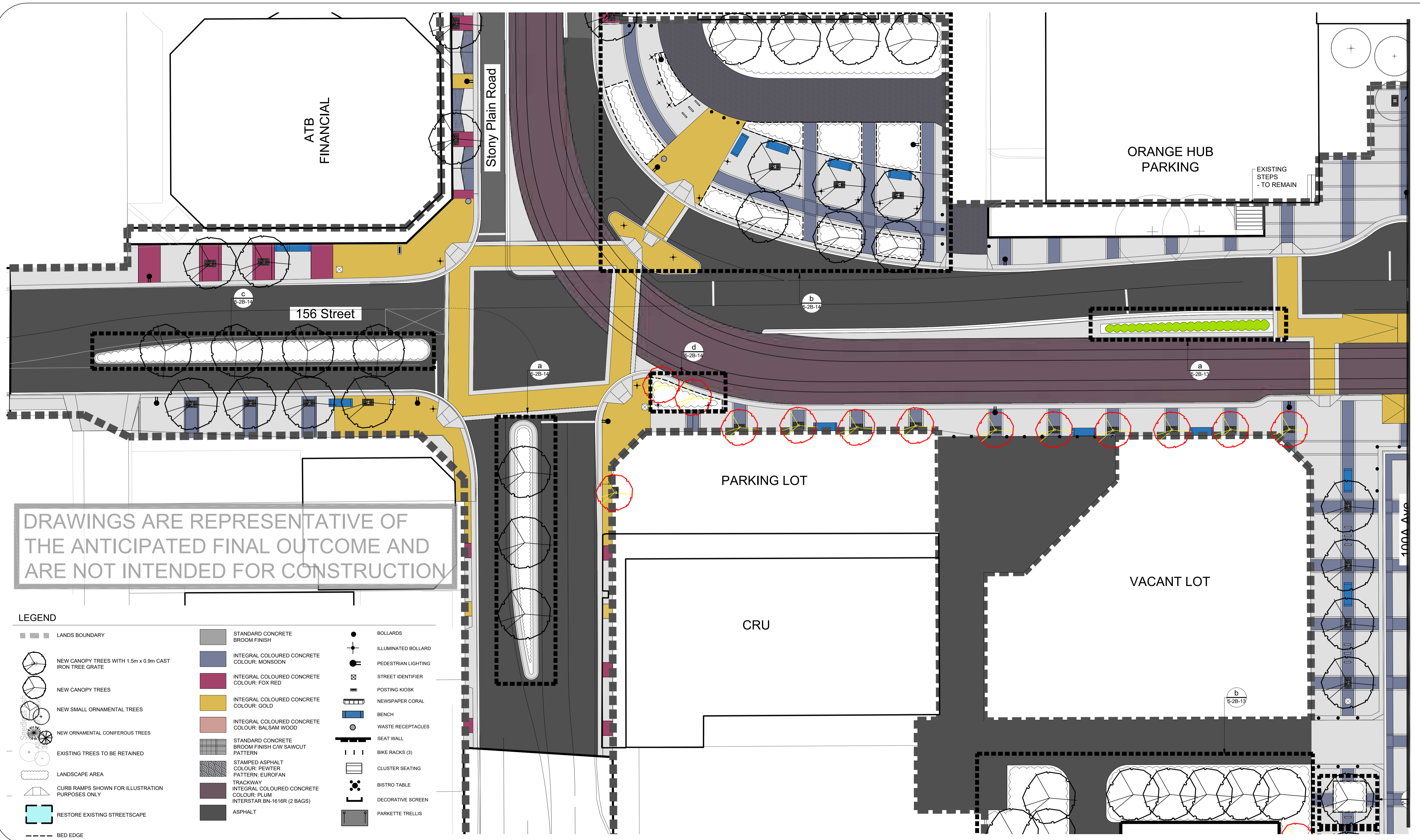
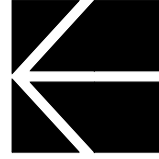

LEGEND

LANDS BOUNDARY	STANDARD CONCRETE BROOM FINISH	BOLLARDS
NEW CANOPY TREES WITH 1.5m x 0.9m CAST IRON TREE GRATE	INTEGRAL COLOURED CONCRETE COLOUR: MONSOON	ILLUMINATED BOLLARD
NEW CANOPY TREES	INTEGRAL COLOURED CONCRETE COLOUR: FOX RED	PEDESTRIAN LIGHTING
NEW SMALL ORNAMENTAL TREES	INTEGRAL COLOURED CONCRETE COLOUR: GOLD	STREET IDENTIFIER
NEW ORNAMENTAL CONIFEROUS TREES	INTEGRAL COLOURED CONCRETE COLOUR: BALSAM WOOD	POSTING KIOSK
EXISTING TREES TO BE RETAINED	STANDARD CONCRETE BROOM FINISH C/W SAWCUT PATTERN	NEWSPAPER CORAL
LANDSCAPE AREA	STAMPED ASPHALT COLOUR: PEWTER PATTERN: EUROFAN	BENCH
CURB RAMPS SHOWN FOR ILLUSTRATION PURPOSES ONLY	TRACKWAY	WASTE RECEPTACLES
RESTORE EXISTING STREETSCAPE	INTEGRAL COLOURED CONCRETE COLOUR: PLUM INTERSTAR BN-1616R (2 BAGS)	SEAT WALL
BED EDGE	ASPHALT	BIKE RACKS (3)
		CLUSTER SEATING
		BISTRO TABLE
		DECORATIVE SCREEN
		PARKETTE TRELLIS

DRAWINGS ARE REPRESENTATIVE OF THE ANTICIPATED FINAL OUTCOME AND ARE NOT INTENDED FOR CONSTRUCTION

no.	description	date	checked
3	ISSUED FOR PA V4	18-9-2020	J.S.
2	ISSUED FOR PA V3	23-7-2020	J.S.
1	ISSUED FOR PA V1R	14-2-2020	B.D.
	revisions		

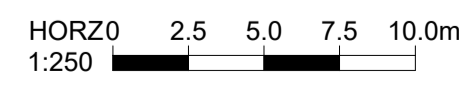

NOT FOR CONSTRUCTION

AECOM
Prime Consultant

Edmonton

HATCH

DIALOG

ISL Engineering and Land Services

M
MOTT MACDONALD

LANDSCAPE
STREETSCAPE DESIGN
STONY PLAIN ROAD & 156 STREET

DRAWING NO: 5-2B-2

MATCHLINE - REFER TO DRAWING 5-2B-1

VALLEY LINE WEST LRT

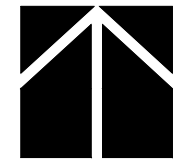

J:\JOHNSON / September 14, 2020 / G:\PROJECTS\1400014854_VALLEY_LINE_LRT_WEST_DESIGN_CAD\20_DRAFTING\2200_LANDSCAPE\0411_102_107_AND_SFR-STREETSCAPE_LAYOUT.DWG

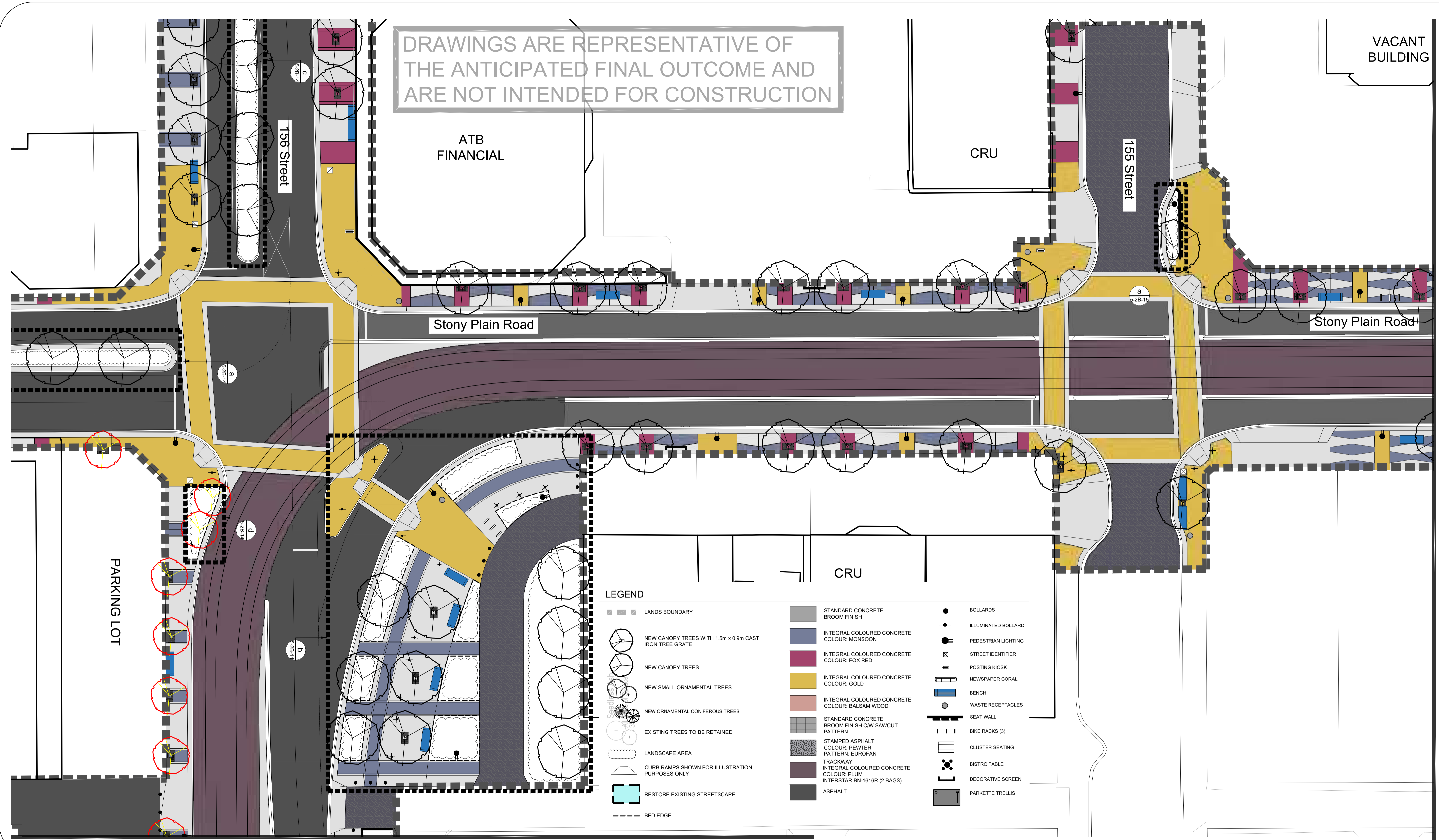

MATCHLINE - REFER TO DRAWING 5-2B-4

VALLEY LINE WEST LRT

MATCHLINE - REFER TO DRAWING 5-2B-2

LEGEND

- LANDS BOUNDARY
- NEW CANOPY TREES WITH 1.5m x 0.9m CAST IRON TREE GRATE
- NEW CANOPY TREES
- NEW SMALL ORNAMENTAL TREES
- NEW ORNAMENTAL CONIFEROUS TREES
- EXISTING TREES TO BE RETAINED
- LANDSCAPE AREA
- CURB RAMPS SHOWN FOR ILLUSTRATION PURPOSES ONLY
- RESTORE EXISTING STREETSCAPE
- BED EDGE
- STANDARD CONCRETE BROOM FINISH
- INTEGRAL COLOURED CONCRETE COLOUR: MONSOON
- INTEGRAL COLOURED CONCRETE COLOUR: FOX RED
- INTEGRAL COLOURED CONCRETE COLOUR: GOLD
- INTEGRAL COLOURED CONCRETE COLOUR: BALSAM WOOD
- STANDARD CONCRETE BROOM FINISH C/W SAWCUT PATTERN
- STAMPED ASPHALT COLOUR: PEWTER PATTERN: EUROFAN
- TRACKWAY INTEGRAL COLOURED CONCRETE COLOUR: PLUM INTERSTAR BN-1616R (2 BAGS)
- ASPHALT
- BOLLARDS
- ILLUMINATED BOLLARD
- PEDESTRIAN LIGHTING
- STREET IDENTIFIER
- POSTING KIOSK
- NEWSPAPER CORAL
- BENCH
- WASTE RECEPTACLES
- SEAT WALL
- BIKE RACKS (3)
- CLUSTER SEATING
- BISTRO TABLE
- DECORATIVE SCREEN
- PARKETTE TRELLIS

no.	description	date	checked
3	ISSUED FOR PA V4	18-9-2020	J.S.
2	ISSUED FOR PA V3	23-7-2020	J.S.
1	ISSUED FOR PA V1R	14-2-2020	B.D.
	revisions		

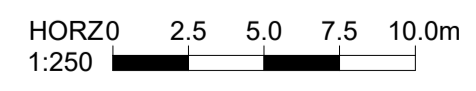

NOT FOR CONSTRUCTION



LANDSCAPE STREETSCAPE DESIGN STONY PLAIN ROAD & 155 STREET

DRAWING NO: 5-2B-3

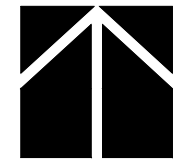

J:\JOHNSON\September 14, 2020\G:\PROJECTS\1400014854_VALLEY_LINE_LRT_WEST_DESIGN_CAD\20_DRAFTING\2200_LANDSCAPE\0411_00_LOCAL_XREF\06_102_107_AND_SPPR\LV\06-0411_102_107_AND_SPPR-STREETSCAPE_LAYOUT.DWG

MATCHLINE - REFER TO DRAWING 5-2B-3

MATCHLINE - REFER TO DRAWING 5-2B-5

VALLEY LINE WEST LRT

DRAWINGS ARE REPRESENTATIVE OF THE ANTICIPATED FINAL OUTCOME AND ARE NOT INTENDED FOR CONSTRUCTION

VACANT BUILDING

CRU

155 Street

AARON'S

154 Street

JASPER PLACE

Stony Plain Road

Ston

CRU

LEGEND

- LANDS BOUNDARY
- NEW CANOPY TREES WITH 1.5m x 0.9m CAST IRON TREE GRATE
- NEW CANOPY TREES
- NEW SMALL ORNAMENTAL TREES
- NEW ORNAMENTAL CONIFEROUS TREES
- EXISTING TREES TO BE RETAINED
- LANDSCAPE AREA
- CURB RAMPS SHOWN FOR ILLUSTRATION PURPOSES ONLY
- RESTORE EXISTING STREETSCAPE
- BED EDGE
- STANDARD CONCRETE BROOM FINISH
- INTEGRAL COLOURED CONCRETE COLOUR: MONSOON
- INTEGRAL COLOURED CONCRETE COLOUR: FOX RED
- INTEGRAL COLOURED CONCRETE COLOUR: GOLD
- INTEGRAL COLOURED CONCRETE COLOUR: BALSAM WOOD
- STANDARD CONCRETE BROOM FINISH C/W SAWCUT PATTERN
- STAMPED ASPHALT COLOUR: PEWTER PATTERN: EUROFAN
- TRACKWAY INTEGRAL COLOURED CONCRETE COLOUR: PLUM INTERSTAR BN-1616R (2 BAGS)
- ASPHALT
- BOLLARDS
- ILLUMINATED BOLLARD
- PEDESTRIAN LIGHTING
- STREET IDENTIFIER
- POSTING KIOSK
- NEWSPAPER CORAL
- BENCH
- WASTE RECEPTACLES
- SEAT WALL
- BIKE RACKS (3)
- CLUSTER SEATING
- BISTRO TABLE
- DECORATIVE SCREEN
- PARKETTE TRELLIS

no.	description	date	checked
3	ISSUED FOR PA V4	18-9-2020	J.S.
2	ISSUED FOR PA V3	23-7-2020	J.S.
1	ISSUED FOR PA V1R	14-2-2020	B.D.
	revisions		

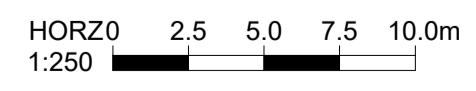

NOT FOR CONSTRUCTION



LANDSCAPE STREETSCAPE DESIGN STONY PLAIN ROAD & 154 STREET

DRAWING NO: 5-2B-4

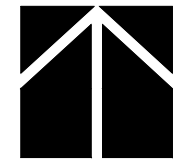

J:\JOHNSON\September 14, 2020\G:\PROJECTS\1400014854_VALLEY_LINE_LRT_WEST_DESIGN_CAD\20_DRAFTING\2200_LANDSCAPE\0411_00_LOCAL_XREF\06_102_107_AND_SFR-STREETSCAPE_LAYOUT.DWG

MATCHLINE - REFER TO DRAWING 5-2B-4

MATCHLINE - REFER TO DRAWING 5-2B-6

VALLEY LINE WEST LRT

DRAWINGS ARE REPRESENTATIVE OF THE ANTICIPATED FINAL OUTCOME AND ARE NOT INTENDED FOR CONSTRUCTION

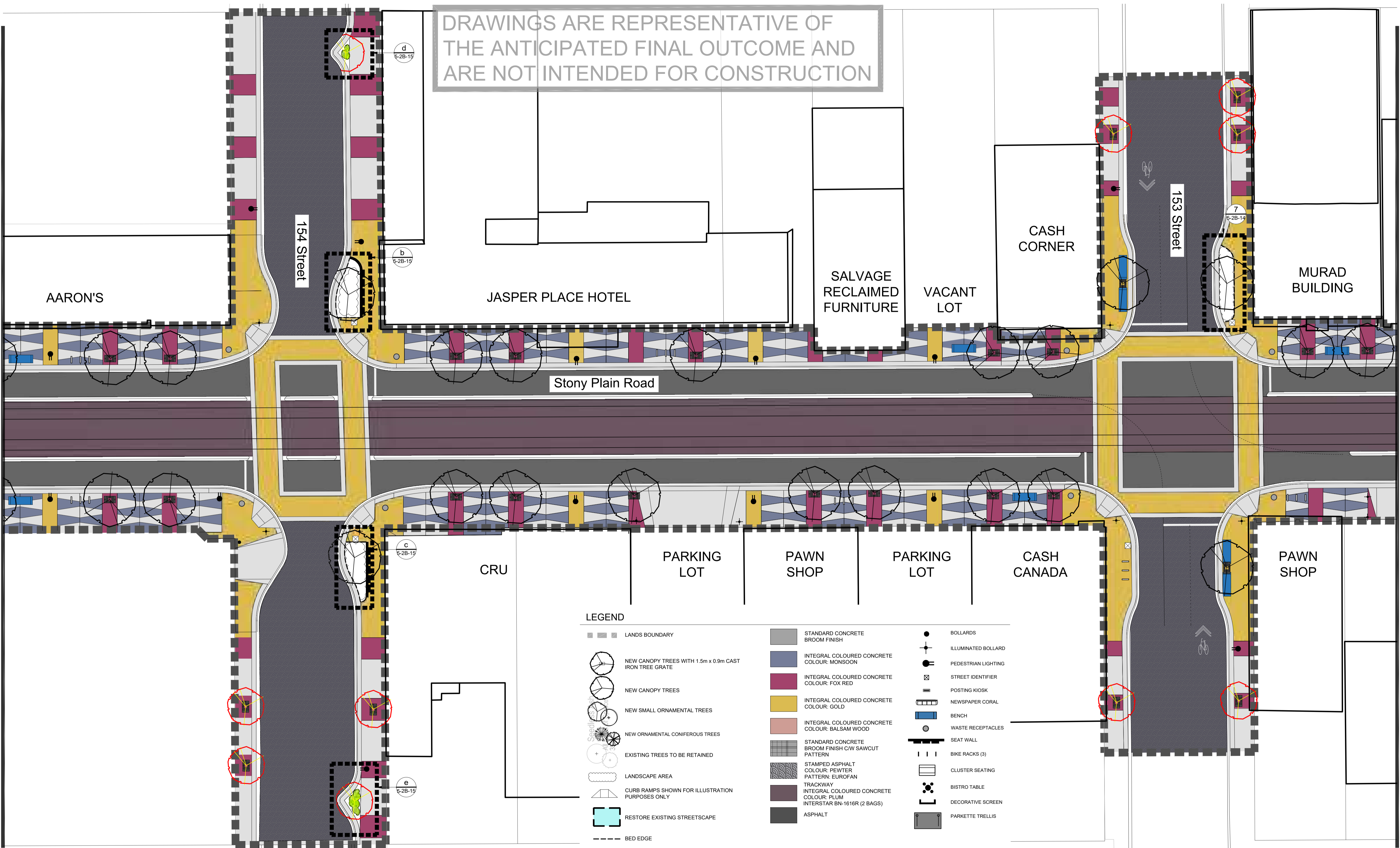

LEGEND

- LANDS BOUNDARY
- NEW CANOPY TREES WITH 1.5m x 0.9m CAST IRON TREE GRATE
- NEW CANOPY TREES
- NEW SMALL ORNAMENTAL TREES
- NEW ORNAMENTAL CONIFEROUS TREES
- EXISTING TREES TO BE RETAINED
- LANDSCAPE AREA
- CURB RAMPS SHOWN FOR ILLUSTRATION PURPOSES ONLY
- RESTORE EXISTING STREETSCAPE
- BED EDGE
- STANDARD CONCRETE BROOM FINISH
- INTEGRAL COLOURED CONCRETE COLOUR: MONSOON
- INTEGRAL COLOURED CONCRETE COLOUR: FOX RED
- INTEGRAL COLOURED CONCRETE COLOUR: GOLD
- INTEGRAL COLOURED CONCRETE COLOUR: BALSAM WOOD
- STANDARD CONCRETE BROOM FINISH C/W SAWCUT PATTERN
- STAMPED ASPHALT COLOUR: PEWTER PATTERN: EUROFAN
- TRACKWAY INTEGRAL COLOURED CONCRETE COLOUR: PLUM INTERSTAR BN-1616R (2 BAGS)
- ASPHALT
- BOLLARDS
- ILLUMINATED BOLLARD
- PEDESTRIAN LIGHTING
- STREET IDENTIFIER
- POSTING KIOSK
- NEWSPAPER CORAL
- BENCH
- WASTE RECEPTACLES
- SEAT WALL
- BIKE RACKS (3)
- CLUSTER SEATING
- BISTRO TABLE
- DECORATIVE SCREEN
- PARKETTE TRELLIS

no.	description	date	checked
3	ISSUED FOR PA V4	18-9-2020	J.S.
2	ISSUED FOR PA V3	23-7-2020	J.S.
1	ISSUED FOR PA V1R	14-2-2020	B.D.
	revisions		

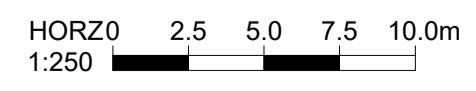

NOT FOR CONSTRUCTION



LANDSCAPE STREETSCAPE DESIGN STONY PLAIN ROAD & 153 STREET

DRAWING NO: 5-2B-5

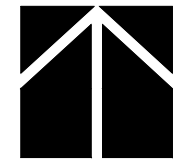

J:\JOHNSON\September 14, 2020\G:\PROJECTS\1400014854_VALLEY_LINE_LRT_WEST_DESIGN_CAD\20_DRAFTING\2200_LANDSCAPE\0411_00_LOCAL_XREF\06_102_107_AND_SPPRV\LD-DB-0411_102_107_AND_SPPR-STREETSCAPE_LAYOUT.DWG

MATCHLINE - REFER TO DRAWING 5-2B-5

MATCHLINE - REFER TO DRAWING 5-2B-7

VALLEY LINE WEST LRT

DRAWINGS ARE REPRESENTATIVE OF THE ANTICIPATED FINAL OUTCOME AND ARE NOT INTENDED FOR CONSTRUCTION

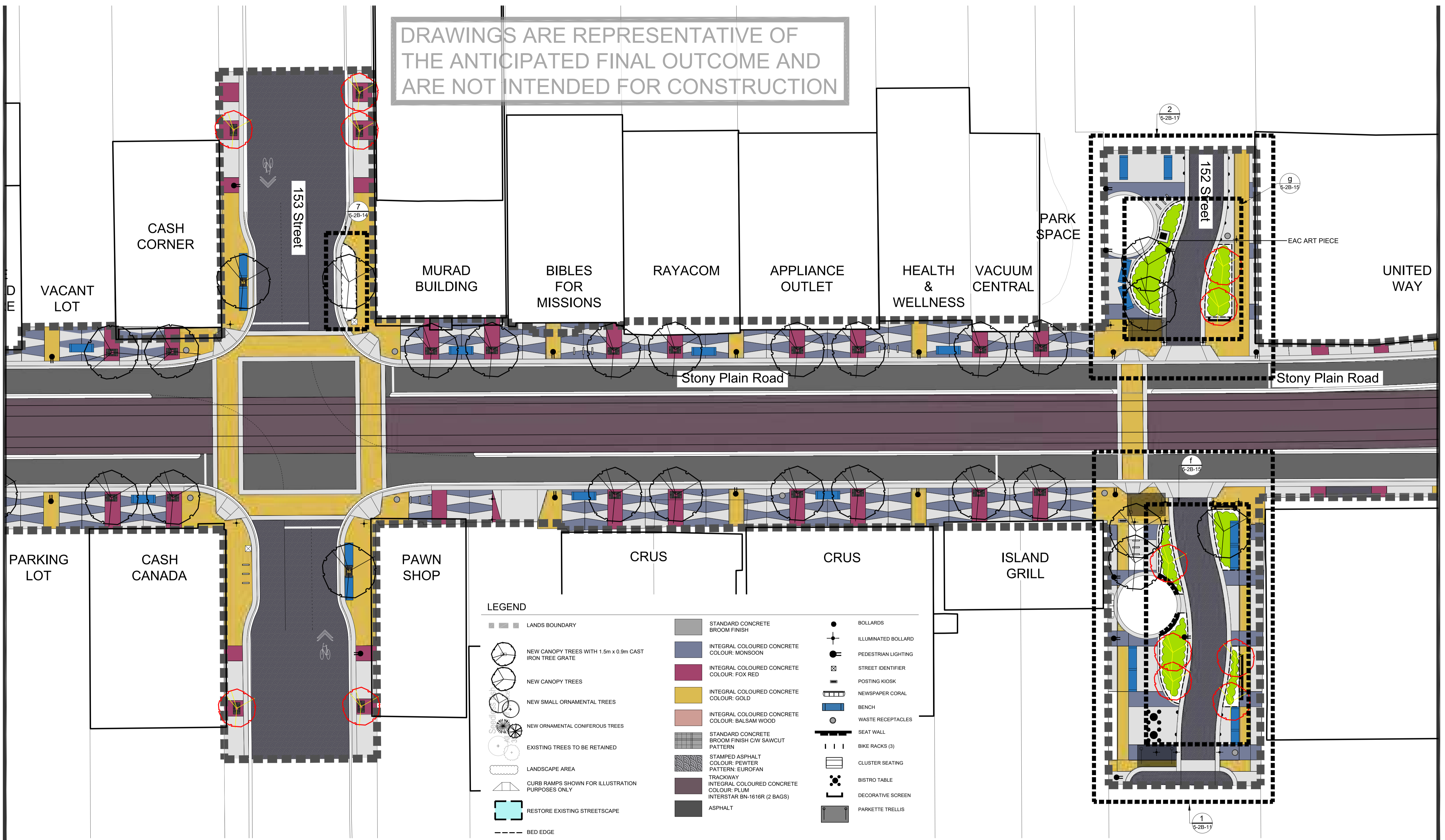

LEGEND

LANDS BOUNDARY	STANDARD CONCRETE BROOM FINISH	BOLLARDS
NEW CANOPY TREES WITH 1.5m x 0.9m CAST IRON TREE GRATE	INTEGRAL COLOURED CONCRETE COLOUR: MONSOON	ILLUMINATED BOLLARD
NEW CANOPY TREES	INTEGRAL COLOURED CONCRETE COLOUR: FOX RED	PEDESTRIAN LIGHTING
NEW SMALL ORNAMENTAL TREES	INTEGRAL COLOURED CONCRETE COLOUR: GOLD	STREET IDENTIFIER
NEW ORNAMENTAL CONIFEROUS TREES	INTEGRAL COLOURED CONCRETE COLOUR: BALSAM WOOD	POSTING KIOSK
EXISTING TREES TO BE RETAINED	STANDARD CONCRETE BROOM FINISH C/W SAWCUT PATTERN	NEWSPAPER CORAL
LANDSCAPE AREA	STAMPED ASPHALT COLOUR: PEWTER PATTERN: EUROFAN	BENCH
CURB RAMPS SHOWN FOR ILLUSTRATION PURPOSES ONLY	TRACKWAY INTEGRAL COLOURED CONCRETE COLOUR: PLUM INTERSTAR BN-1616R (2 BAGS)	WASTE RECEPTACLES
RESTORE EXISTING STREETSCAPE	ASPHALT	SEAT WALL
BED EDGE		BIKE RACKS (3)
		CLUSTER SEATING
		BISTRO TABLE
		DECORATIVE SCREEN
		PARKETTE TRELLIS

no.	description	date	checked
3	ISSUED FOR PA V4	18-9-2020	J.S.
2	ISSUED FOR PA V3	23-7-2020	J.S.
1	ISSUED FOR PA V1R	14-2-2020	B.D.
	revisions		

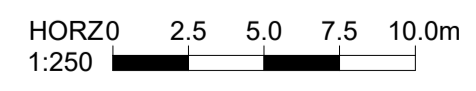

NOT FOR CONSTRUCTION

AECOM
Prime Consultant

Edmonton

HATCH

DIALOG

ISL Engineering and Land Services

M M
MOTT MACDONALD

LANDSCAPE
STREETSCAPE DESIGN
STONY PLAIN ROAD & 152 STREET

DRAWING NO: 5-2B-6

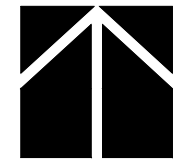

J:\JOHNSON\September 14, 2020\G:\PROJECTS\1400014854_VALLEY_LINE_LRT_WEST_DESIGN_CAD\20_DRAFTING\2200_LANDSCAPE\0411_00_LOCAL_XREF\06_102_107_AND_SPPRV\LD-DB-0411_102_107_AND_SPPR-STREETSCAPE_LAYOUT.DWG

MATCHLINE - REFER TO DRAWING 5-2B-6

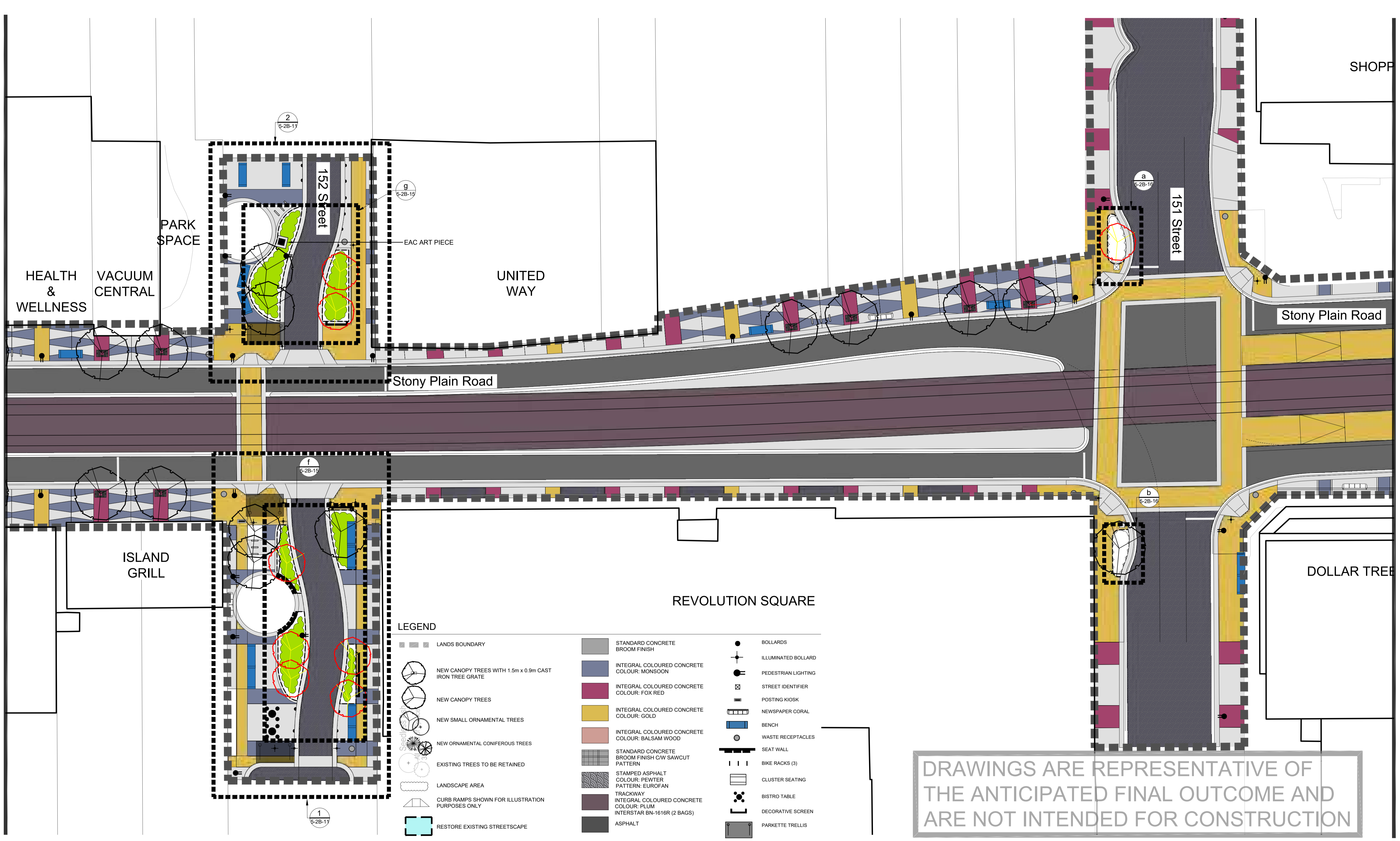

MATCHLINE - REFER TO DRAWING 5-2B-8

VALLEY LINE WEST LRT

LEGEND

- LANDS BOUNDARY
- NEW CANOPY TREES WITH 1.5m x 0.9m CAST IRON TREE GRATE
- NEW CANOPY TREES
- NEW SMALL ORNAMENTAL TREES
- NEW ORNAMENTAL CONIFEROUS TREES
- EXISTING TREES TO BE RETAINED
- LANDSCAPE AREA
- CURB RAMPS SHOWN FOR ILLUSTRATION PURPOSES ONLY
- RESTORE EXISTING STREETSCAPE
- BED EDGE
- STANDARD CONCRETE BROOM FINISH
- INTEGRAL COLOURED CONCRETE COLOUR: MONSOON
- INTEGRAL COLOURED CONCRETE COLOUR: FOX RED
- INTEGRAL COLOURED CONCRETE COLOUR: GOLD
- INTEGRAL COLOURED CONCRETE COLOUR: BALSAM WOOD
- STANDARD CONCRETE BROOM FINISH C/W SAWCUT PATTERN
- STAMPED ASPHALT COLOUR: FEWTER PATTERN: EUROFAN TRACKWAY
- INTEGRAL COLOURED CONCRETE COLOUR: PLUM INTERSTAR BN-1616R (2 BAGS)
- ASPHALT
- BOLLARDS
- ILLUMINATED BOLLARD
- PEDESTRIAN LIGHTING
- STREET IDENTIFIER
- POSTING KIOSK
- NEWSPAPER CORAL
- BENCH
- WASTE RECEPTACLES
- SEAT WALL
- BIKE RACKS (3)
- CLUSTER SEATING
- BISTRO TABLE
- DECORATIVE SCREEN
- PARKETTE TRELLIS

DRAWINGS ARE REPRESENTATIVE OF THE ANTICIPATED FINAL OUTCOME AND ARE NOT INTENDED FOR CONSTRUCTION

no.	description	date	checked
3	ISSUED FOR PA V4	18-9-2020	J.S.
2	ISSUED FOR PA V3	23-7-2020	J.S.
1	ISSUED FOR PA V1R	14-2-2020	B.D.
	revisions		

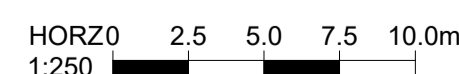

NOT FOR CONSTRUCTION



LANDSCAPE STREETSCAPE DESIGN STONY PLAIN ROAD & 151 STREET

DRAWING NO: 5-2B-7

J:\JOHNSON / September 14, 2020 / G:\PROJECTS\1400014854_VALLEY_LINE_LRT_WEST_DESIGN_CAD\20_DRAFTING\2200_LANDSCAPE\0411_102_107_AND_SPPRV\LD-DB-0411_102_107_AND_SPPR-STREETSCAPE_LAYOUT.DWG

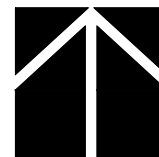

MATCHLINE - REFER TO DRAWING 5-2B-7

MATCHLINE - REFER TO DRAWING 5-2B-9

VALLEY LINE WEST LRT

DRAWINGS ARE REPRESENTATIVE OF THE ANTICIPATED FINAL OUTCOME AND ARE NOT INTENDED FOR CONSTRUCTION

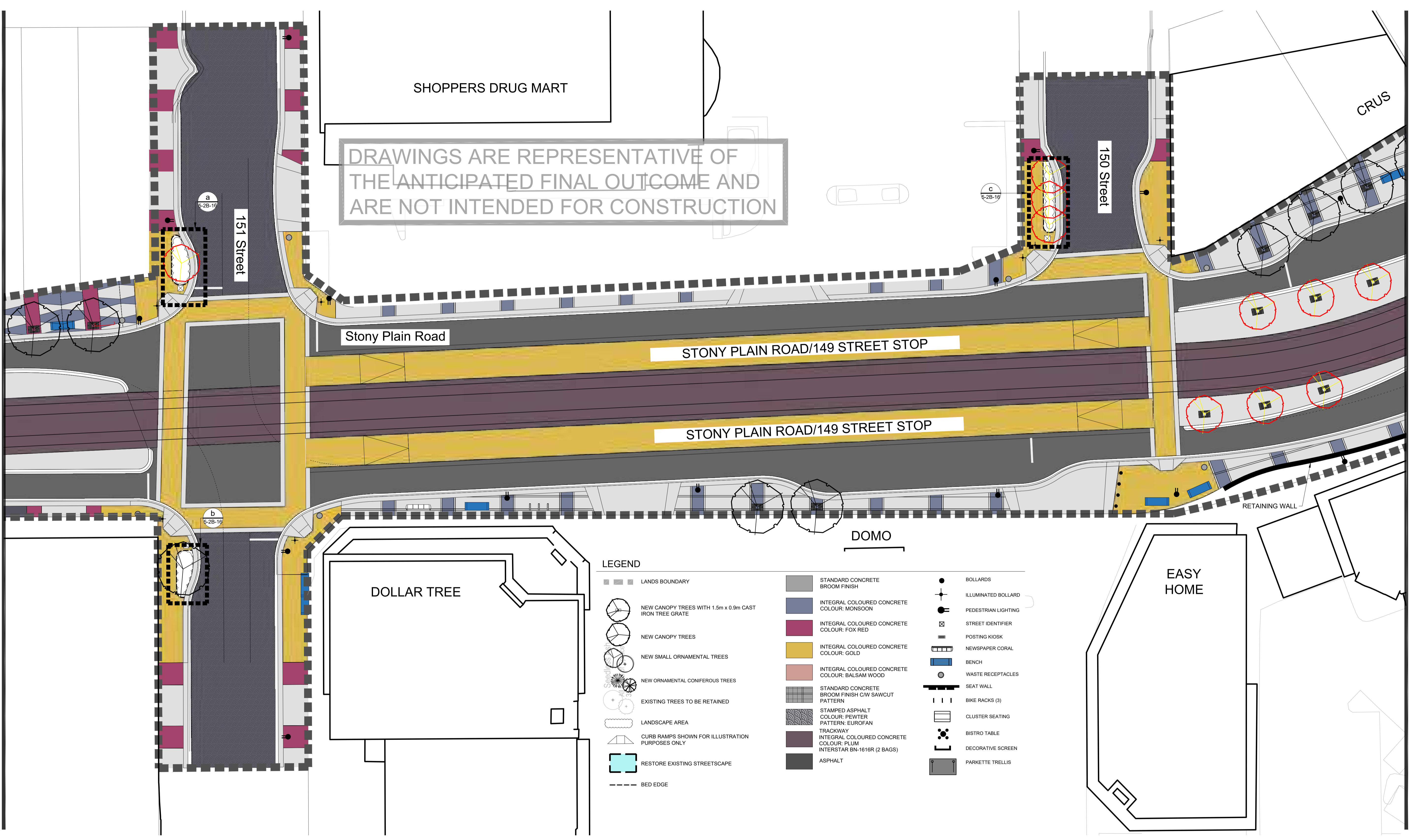

LEGEND

- LANDS BOUNDARY
- NEW CANOPY TREES WITH 1.5m x 0.9m CAST IRON TREE GRATE
- NEW CANOPY TREES
- NEW SMALL ORNAMENTAL TREES
- NEW ORNAMENTAL CONIFEROUS TREES
- EXISTING TREES TO BE RETAINED
- LANDSCAPE AREA
- CURB RAMPS SHOWN FOR ILLUSTRATION PURPOSES ONLY
- RESTORE EXISTING STREETSCAPE
- BED EDGE
- STANDARD CONCRETE BROOM FINISH
- INTEGRAL COLOURED CONCRETE COLOUR: MONSOON
- INTEGRAL COLOURED CONCRETE COLOUR: FOX RED
- INTEGRAL COLOURED CONCRETE COLOUR: GOLD
- INTEGRAL COLOURED CONCRETE COLOUR: BALSAM WOOD
- STANDARD CONCRETE BROOM FINISH C/W SAWCUT PATTERN
- STAMPED ASPHALT COLOUR: PEWTER PATTERN: EUROFAN
- TRACKWAY INTEGRAL COLOURED CONCRETE COLOUR: PLUM INTERSTAR BN-1616R (2 BAGS)
- ASPHALT
- BOLLARDS
- ILLUMINATED BOLLARD
- PEDESTRIAN LIGHTING
- STREET IDENTIFIER
- POSTING KIOSK
- NEWSPAPER CORAL
- BENCH
- WASTE RECEPTACLES
- SEAT WALL
- BIKE RACKS (3)
- CLUSTER SEATING
- BISTRO TABLE
- DECORATIVE SCREEN
- PARKETTE TRELLIS

no.	description	date	checked
3	ISSUED FOR PA V4	18-9-2020	J.S.
2	ISSUED FOR PA V3	23-7-2020	J.S.
1	ISSUED FOR PA V1R	14-2-2020	B.D.
	revisions		

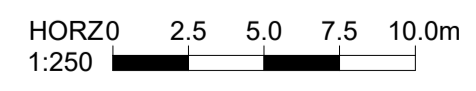

NOT FOR CONSTRUCTION



LANDSCAPE STREETSCAPE DESIGN
STONY PLAIN ROAD & 150 STREET

DRAWING NO: 5-2B-8

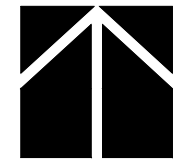

LEGEND

- LANDS BOUNDARY
- NEW CANOPY TREES WITH 1.5m x 0.9m CAST IRON TREE GRATE
- NEW CANOPY TREES
- NEW SMALL ORNAMENTAL TREES
- NEW ORNAMENTAL CONIFEROUS TREES
- EXISTING TREES TO BE RETAINED
- LANDSCAPE AREA
- CURB RAMPS SHOWN FOR ILLUSTRATION PURPOSES ONLY
- RESTORE EXISTING STREETScape
- BED EDGE
- STANDARD CONCRETE BROOM FINISH
- INTEGRAL COLOURED CONCRETE COLOUR: MONSOON
- INTEGRAL COLOURED CONCRETE COLOUR: FOX RED
- INTEGRAL COLOURED CONCRETE COLOUR: GOLD
- INTEGRAL COLOURED CONCRETE COLOUR: BALSAM WOOD
- STANDARD CONCRETE BROOM FINISH C/W SAWCUT PATTERN
- STAMPED ASPHALT COLOUR: PEWTER PATTERN: EUROFAN
- TRACKWAY INTEGRAL COLOURED CONCRETE COLOUR: PLUM INTERSTAR BN-1616R (2 BAGS)
- ASPHALT
- BOLLARDS
- ILLUMINATED BOLLARD
- PEDESTRIAN LIGHTING
- STREET IDENTIFIER
- POSTING KIOSK
- NEWSPAPER CORAL
- BENCH
- WASTE RECEPTACLES
- SEAT WALL
- BIKE RACKS (3)
- CLUSTER SEATING
- BISTRO TABLE
- DECORATIVE SCREEN
- PARKETTE TRELLIS

MATCHLINE - REFER TO DRAWING 5-2B-8

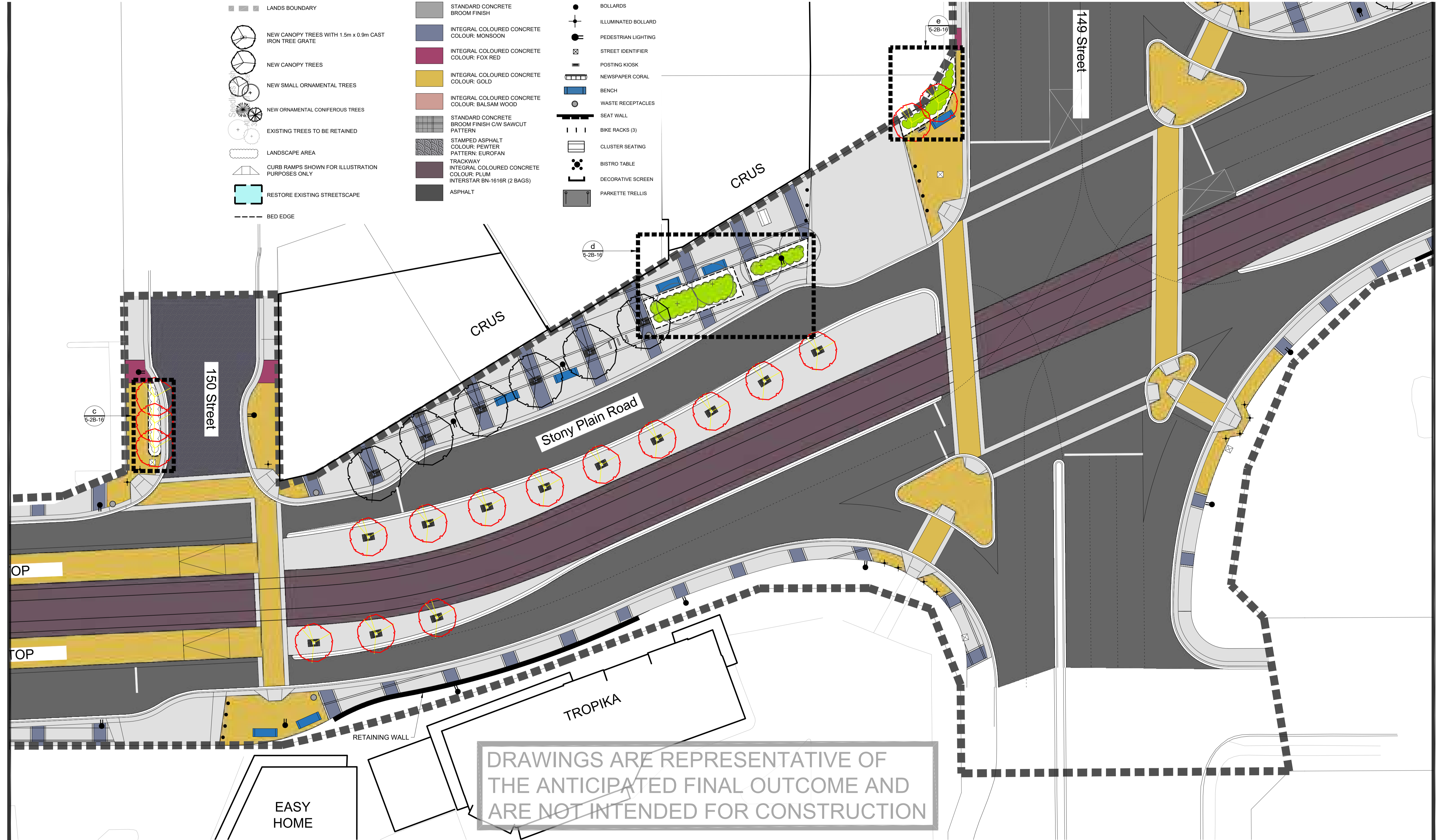

MATCHLINE - REFER TO DRAWING 5-2B-10

VALLEY LINE WEST LRT

DRAWINGS ARE REPRESENTATIVE OF THE ANTICIPATED FINAL OUTCOME AND ARE NOT INTENDED FOR CONSTRUCTION

no.	description	date	checked
3	ISSUED FOR PA V4	18-9-2020	J.S.
2	ISSUED FOR PA V3	23-7-2020	J.S.
1	ISSUED FOR PA V1R	14-2-2020	B.D.
	revisions		

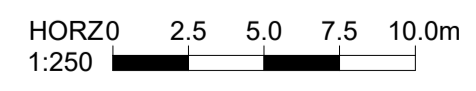

NOT FOR CONSTRUCTION



LANDSCAPE STREETScape DESIGN
STONY PLAIN ROAD & 149 STREET
DRAWING NO: 5-2B-9

J:\JOHNSON\September 14, 2020\G:\PROJECTS\140001480014854_VALLEY_LINE_LRT_WEST_DESIGN_CAD\20_DRAFTING\2200_LANDSCAPE\0411_102_107_AND_SPPR\1400014854_VALLEY_LINE_LRT_WEST_DESIGN_CAD\20_DRAFTING\2200_LANDSCAPE\0411_102_107_AND_SPPR-STREETScape_LAYOUT.DWG

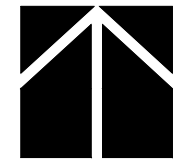

J:\JOHNSON\September 14, 2020\G:\PROJECTS\1400014854_VALLEY_LINE_LRT_WEST_DESIGN_CADD\20_DRAFTING\2200_LANDSCAPE\0411_102_107_AND_SPPRV\WDB-0411-102_107_AND_SPP-STREETSCAPE_LAYOUT.DWG

MATCHLINE - REFER TO DRAWING 5-2B-9

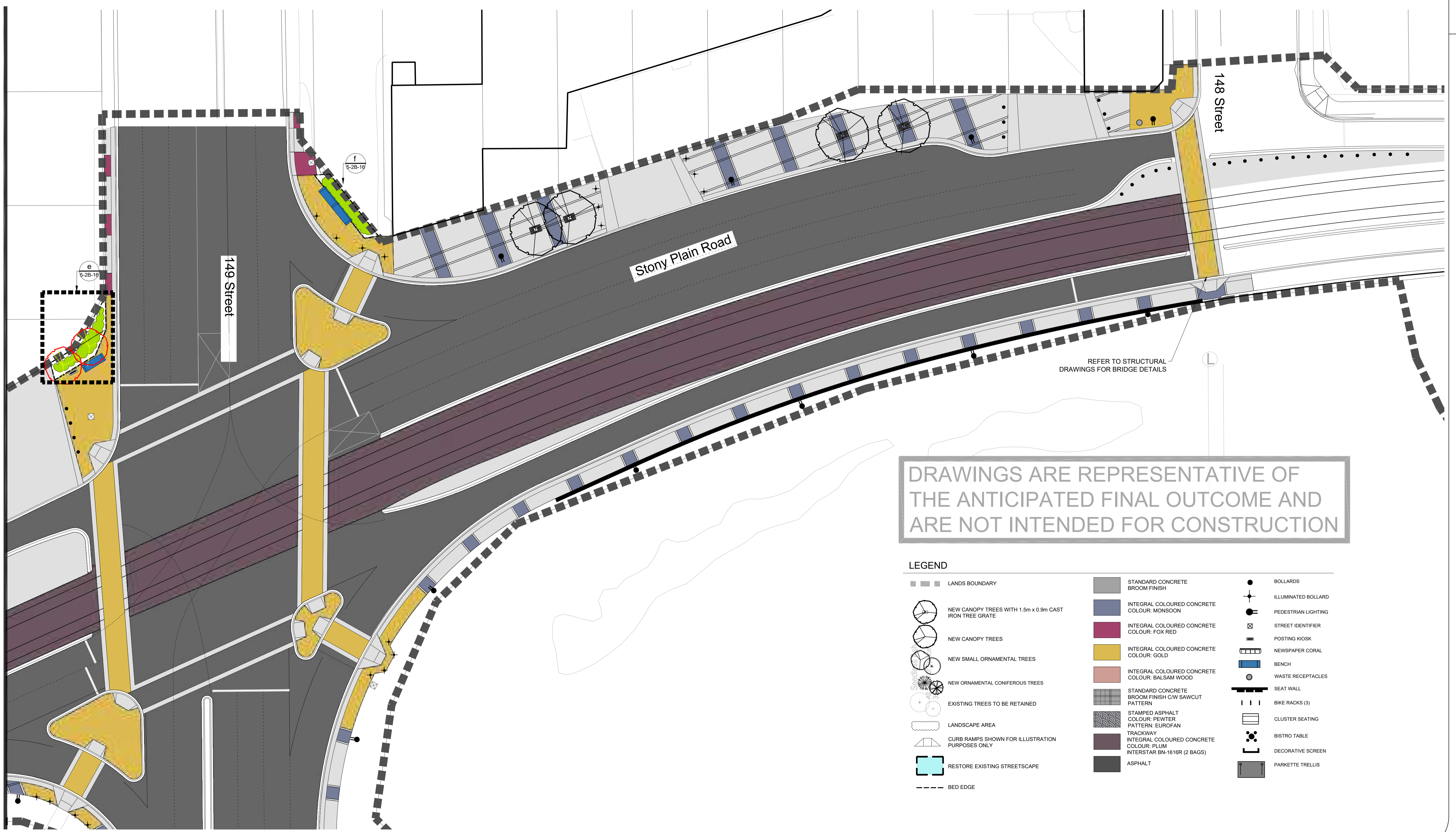

DRAWINGS ARE REPRESENTATIVE OF THE ANTICIPATED FINAL OUTCOME AND ARE NOT INTENDED FOR CONSTRUCTION

LEGEND

- LANDS BOUNDARY
- NEW CANOPY TREES WITH 1.5m x 0.9m CAST IRON TREE GRATE
- NEW CANOPY TREES
- NEW SMALL ORNAMENTAL TREES
- NEW ORNAMENTAL CONIFEROUS TREES
- EXISTING TREES TO BE RETAINED
- LANDSCAPE AREA
- CURB RAMPS SHOWN FOR ILLUSTRATION PURPOSES ONLY
- RESTORE EXISTING STREETSCAPE
- BED EDGE
- STANDARD CONCRETE BROOM FINISH
- INTEGRAL COLOURED CONCRETE COLOUR: MONSOON
- INTEGRAL COLOURED CONCRETE COLOUR: FOX RED
- INTEGRAL COLOURED CONCRETE COLOUR: GOLD
- INTEGRAL COLOURED CONCRETE COLOUR: BALSAM WOOD
- STANDARD CONCRETE BROOM FINISH C/W SAWCUT PATTERN
- STAMPED ASPHALT COLOUR: PEWTER PATTERN: EUROFAN TRACKWAY
- INTEGRAL COLOURED CONCRETE COLOUR: PLUM INTERSTAR BN-1616R (2 BAGS)
- ASPHALT
- BOLLARDS
- ILLUMINATED BOLLARD
- PEDESTRIAN LIGHTING
- STREET IDENTIFIER
- POSTING KIOSK
- NEWSPAPER CORAL
- BENCH
- WASTE RECEPTACLES
- SEAT WALL
- BIKE RACKS (3)
- CLUSTER SEATING
- BISTRO TABLE
- DECORATIVE SCREEN
- PARKETTE TRELLIS

REFER TO STRUCTURAL DRAWINGS FOR BRIDGE DETAILS

VALLEY LINE WEST LRT

no.	description	date	checked
3	ISSUED FOR PA V4	18-9-2020	J.S.
2	ISSUED FOR PA V3	23-7-2020	J.S.
1	ISSUED FOR PA V1R	14-2-2020	B.D.
	revisions		

HORZO 1:250 2.5 5.0 7.5 10.0m

NOT FOR CONSTRUCTION

AECOM Prime Consultant

Edmonton

HATCH

DIALOG

ISL Engineering and Land Services

M M MOTT MACDONALD

LANDSCAPE STREETSCAPE DESIGN STONY PLAIN ROAD & 148 STREET

DRAWING NO: 5-2B-10

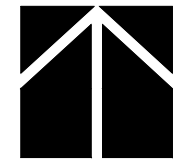

J:\JOHNSON\September 14, 2020\G:\PROJECTS\1400014854_VALLEY_LINE_LRT_WEST_DESIGN_CED\2_CADD\30_DRAFTING\2200_LANDSCAPE\0411_00_LOCAL_XREF\06_102_107_AND_SPPRV\WDB-0411-102_107_AND_SPPR-STREETSCAPE_LAYOUT.DWG

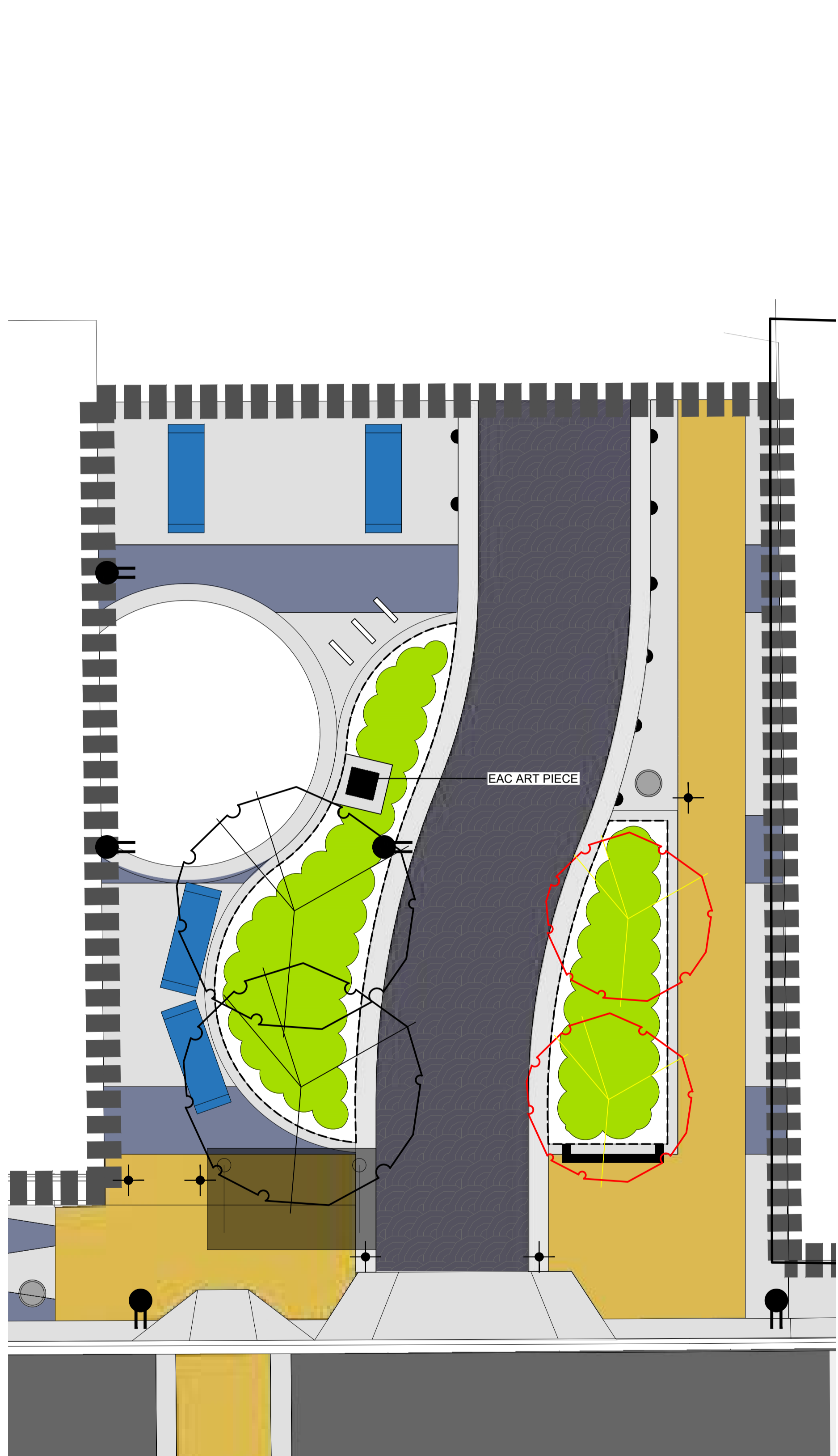
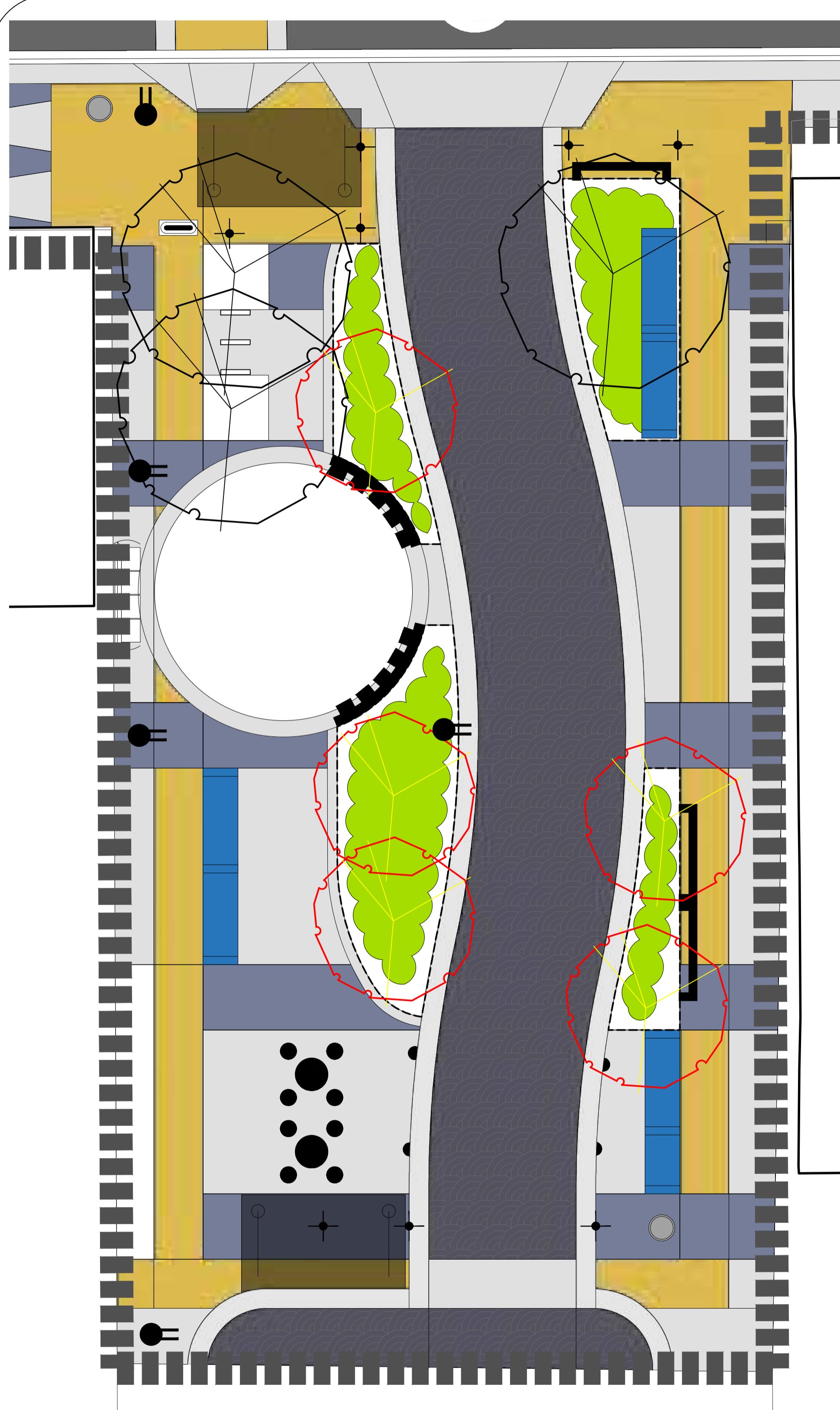

LEGEND

- LANDS BOUNDARY
- NEW CANOPY TREES WITH 1.5m x 0.9m CAST IRON TREE GRATE
- NEW CANOPY TREES
- NEW SMALL ORNAMENTAL TREES
- NEW ORNAMENTAL CONIFEROUS TREES
- EXISTING TREES TO BE RETAINED
- LANDSCAPE AREA
- CURB RAMPS SHOWN FOR ILLUSTRATION PURPOSES ONLY
- RESTORE EXISTING STREETSCAPE
- BED EDGE
- STANDARD CONCRETE BROOM FINISH
- INTEGRAL COLOURED CONCRETE COLOUR: MONSOON
- INTEGRAL COLOURED CONCRETE COLOUR: FOX RED
- INTEGRAL COLOURED CONCRETE COLOUR: GOLD
- INTEGRAL COLOURED CONCRETE COLOUR: BALSAM WOOD
- STANDARD CONCRETE BROOM FINISH CW SAWCUT PATTERN
- STAMPED ASPHALT COLOUR: PEWTER PATTERN: EUROFAN
- TRACKWAY INTEGRAL COLOURED CONCRETE COLOUR: PLUM INTERSTAR BN-1616R (2 BAGS)
- ASPHALT
- BOLLARDS
- ILLUMINATED BOLLARD
- PEDESTRIAN LIGHTING
- STREET IDENTIFIER
- POSTING KIOSK
- NEWSPAPER CORAL
- BENCH
- WASTE RECEPTACLES
- SEAT WALL
- BIKE RACKS (3)
- CLUSTER SEATING
- BISTRO TABLE
- DECORATIVE SCREEN
- PARKETTE TRELLIS

DRAWINGS ARE REPRESENTATIVE OF THE ANTICIPATED FINAL OUTCOME AND ARE NOT INTENDED FOR CONSTRUCTION

1 STREETScape ENLARGEMENT 152 ST SOUTH SCALE 1:100

2 STREETScape ENLARGEMENT 152 ST NORTH SCALE 1:100

3 CAST-IN-PLACE PLANTER CURB SCALE 1:5

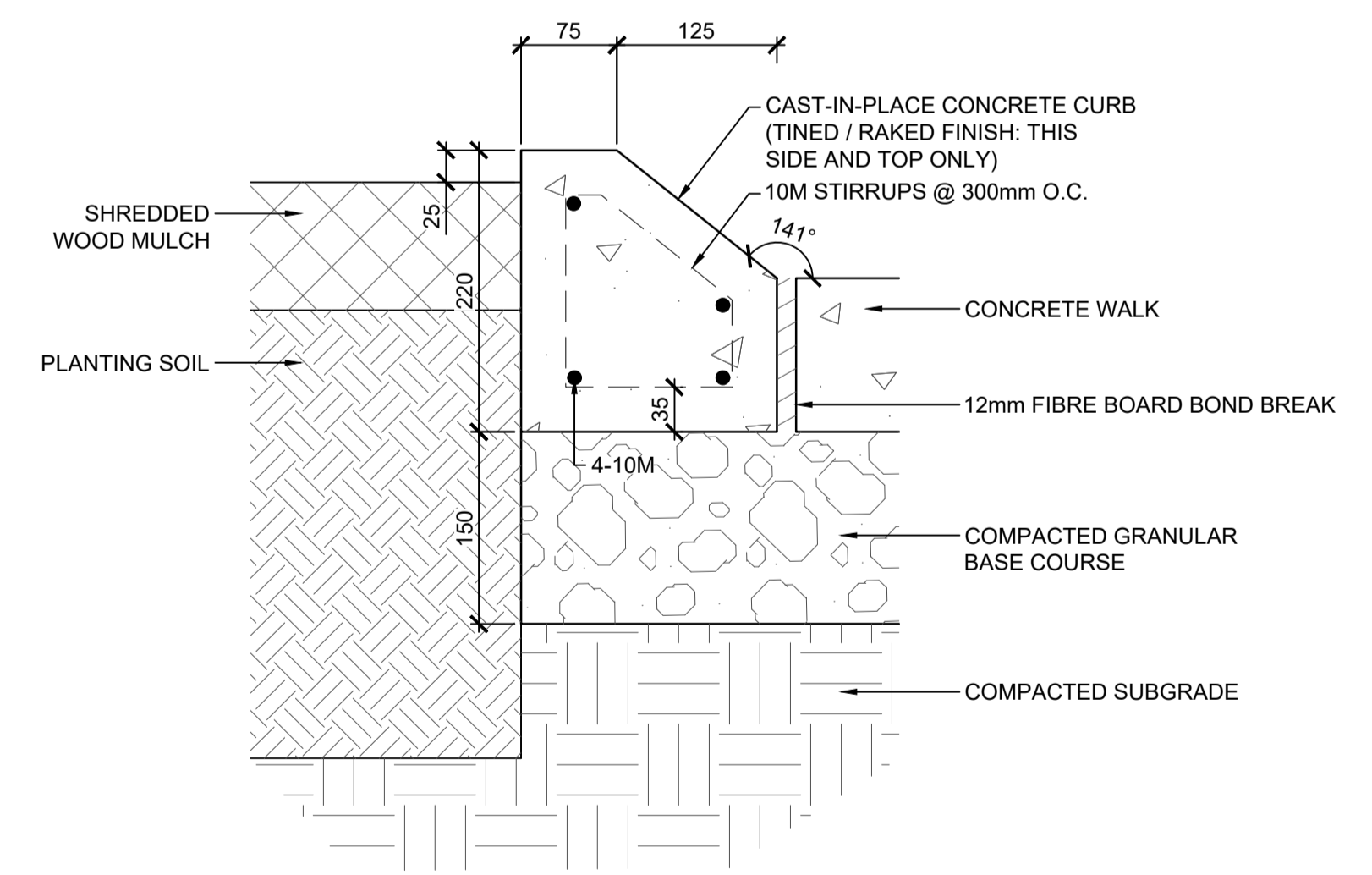

no.	description	date	checked
3	ISSUED FOR PA V4	18-9-2020	J.S.
2	ISSUED FOR PA V3	23-7-2020	J.S.
1	ISSUED FOR PA VIR	14-2-2020	B.D.
	revisions		

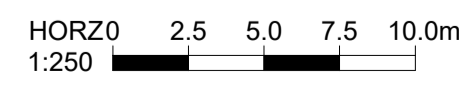

NOT FOR CONSTRUCTION



LANDSCAPE STREETScape DESIGN STONY PLAIN ROAD

DRAWING NO: 5-2B-11

VALLEY LINE WEST LRT

J:\JOHNSON / September 15, 2020 / G:\PROJECTS\140001480014854_VALLEY_LINE_LRT_WEST_DESIGN_CADD\20_DRAFTING\200_LANDSCAPE\0411_00_LOCAL_XREF\06_102_107_AND_SRRV\LD-DB-0411-102_107_AND_SRRV_PLANTING_LAYOUT.DWG

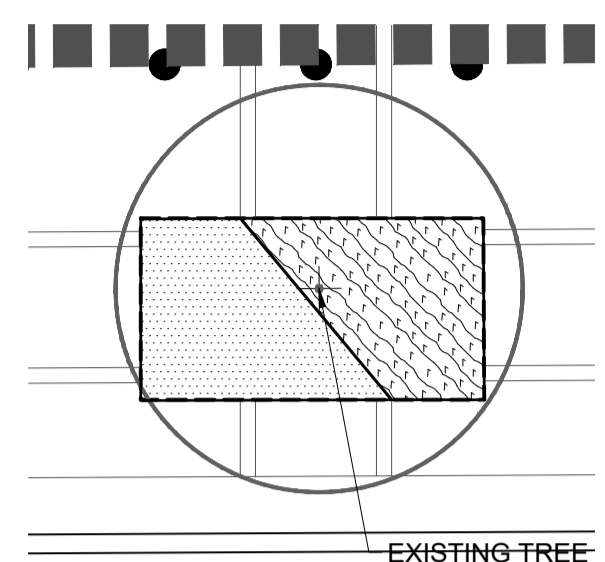

a PLANTING ENLARGEMENT
PLAN SCALE 1:100

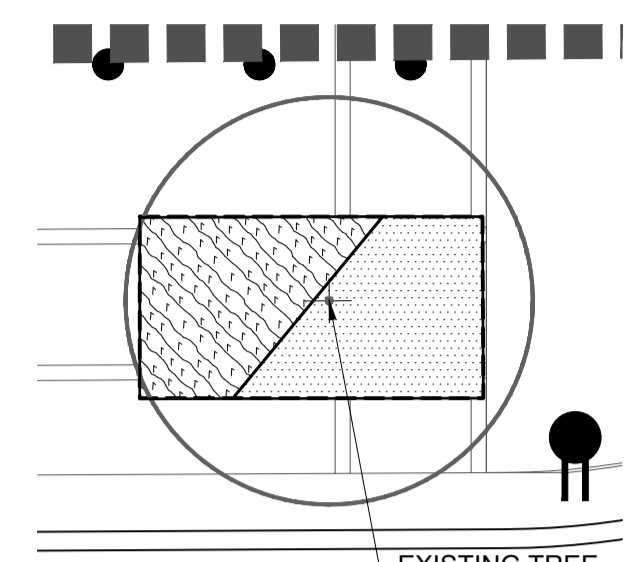

b PLANTING ENLARGEMENT
PLAN SCALE 1:100

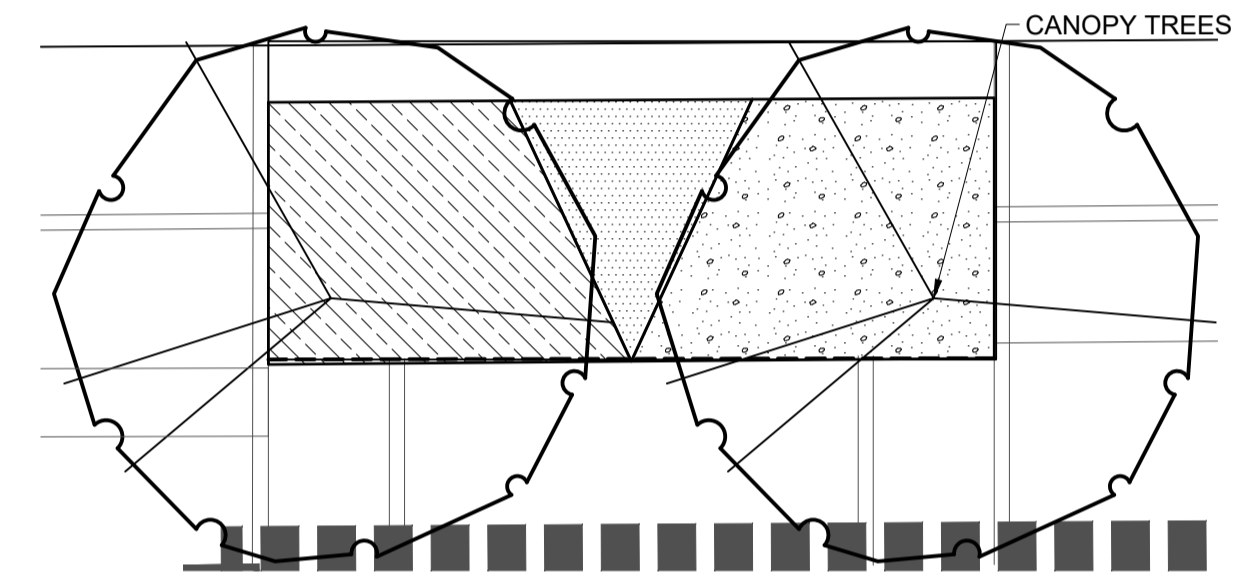

c PLANTING ENLARGEMENT
PLAN SCALE 1:100

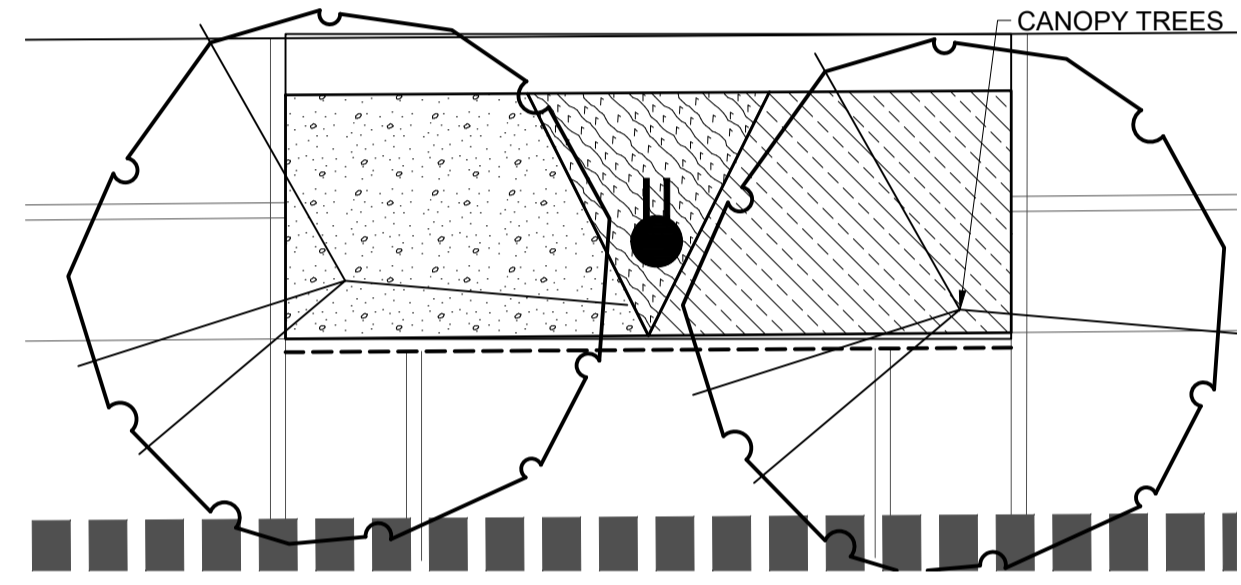

d PLANTING ENLARGEMENT
PLAN SCALE 1:100

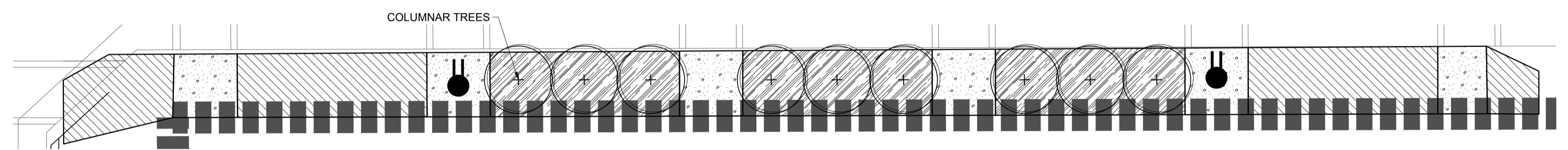

e PLANTING ENLARGEMENT
PLAN SCALE 1:100

PLANT SCHEDULE JASPER PLACE

SHRUB AREAS	CODE	BOTANICAL NAME	COMMON NAME
	Br	Berberis thunbergii 'Rose Glow'	Rosy Glow Barberry
	Bt	Berberis x 'Tara' TM	Emerald Carousel Barberry
	Bc	Bergenia cordifolia	Heartleaf Bergenia
	Fg	Festuca glauca	Blue Fescue
	Ho	Hemerocallis x 'Stella de Oro'	Stella de Oro Daylily
	Jb	Juniperus horizontalis 'Blue Prince'	Blue Prince Juniper
	Ps	Panicum virgatum 'Shenandoah'	Switch Grass
	Pd	Physocarpus opulifolius 'Diabolo'	Diablo Ninebark
	Pa	Potentilla fruticosa 'Abbotswood'	Abbotswood Potentilla
	Sa	Spiraea x arguta 'Compacta'	Dwarf Garland Spirea
	Vn	Viburnum opulus 'Nanum'	Dwarf European Cranberry
	Turf		
			Lands Boundary

DRAWINGS ARE REPRESENTATIVE OF THE ANTICIPATED FINAL OUTCOME AND ARE NOT INTENDED FOR CONSTRUCTION

VALLEY LINE WEST LRT

no.	description	date	checked
3	ISSUED FOR PA V4	18-9-2020	J.S.
2	ISSUED FOR PA V3	23-7-2020	J.S.
1	ISSUED FOR PA V1R	14-2-2020	B.D.
	revisions		

NOT FOR CONSTRUCTION

NOT FOR CONSTRUCTION



LANDSCAPE
STREETSCAPE DESIGN
156 STREET

DRAWING NO: 5-2B-12

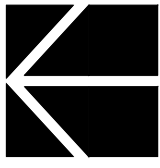

DRAWINGS ARE REPRESENTATIVE OF THE ANTICIPATED FINAL OUTCOME AND ARE NOT INTENDED FOR CONSTRUCTION

PLANT SCHEDULE JASPER PLACE

SHRUB AREAS	CODE	BOTANICAL NAME	COMMON NAME
	Br	Berberis thunbergii 'Rose Glow'	Rosy Glow Barberry
	Bt	Berberis x 'Tara' TM	Emerald Carousel Barberry
	Bc	Bergenia cordifolia	Heartleaf Bergenia
	Fg	Festuca glauca	Blue Fescue
	Ho	Hemerocallis x 'Stella de Oro'	Stella de Oro Daylily
	Jb	Juniperus horizontalis 'Blue Prince'	Blue Prince Juniper
	Ps	Panicum virgatum 'Shenandoah'	Switch Grass
	Pd	Physocarpus opulifolius 'Diabolo'	Diablo Ninebark
	Pa	Potentilla fruticosa 'Abbotswood'	Abbotswood Potentilla
	Sa	Spiraea x arguta 'Compacta'	Dwarf Garland Spirea
	Vn	Viburnum opulus 'Nanum'	Dwarf European Cranberry
		Turf	
		Lands Boundary	

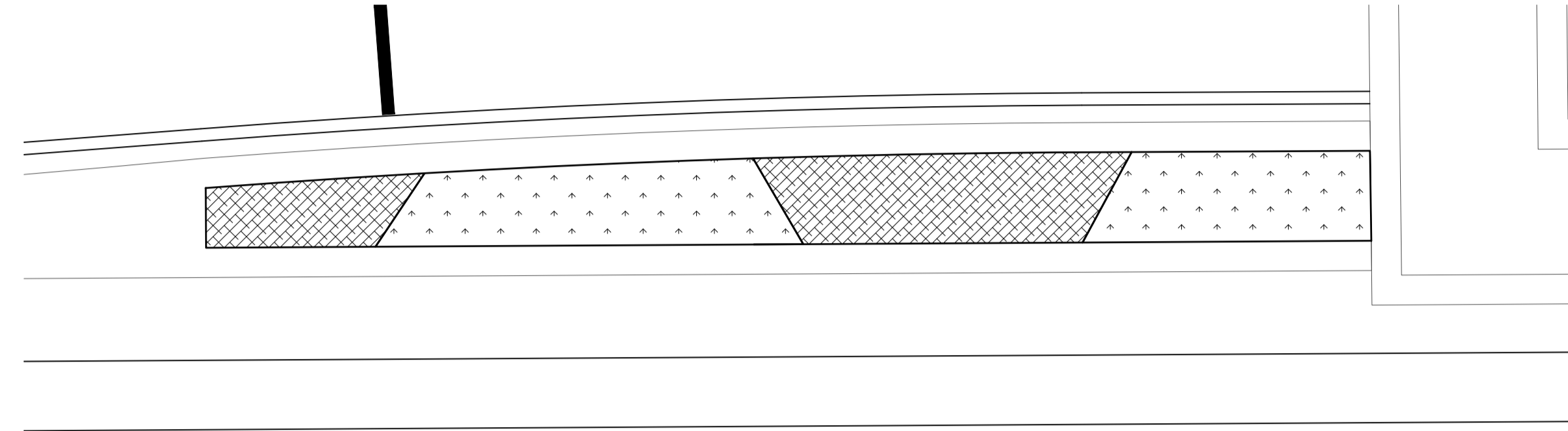

a PLANTING ENLARGEMENT
PLAN SCALE 1:100

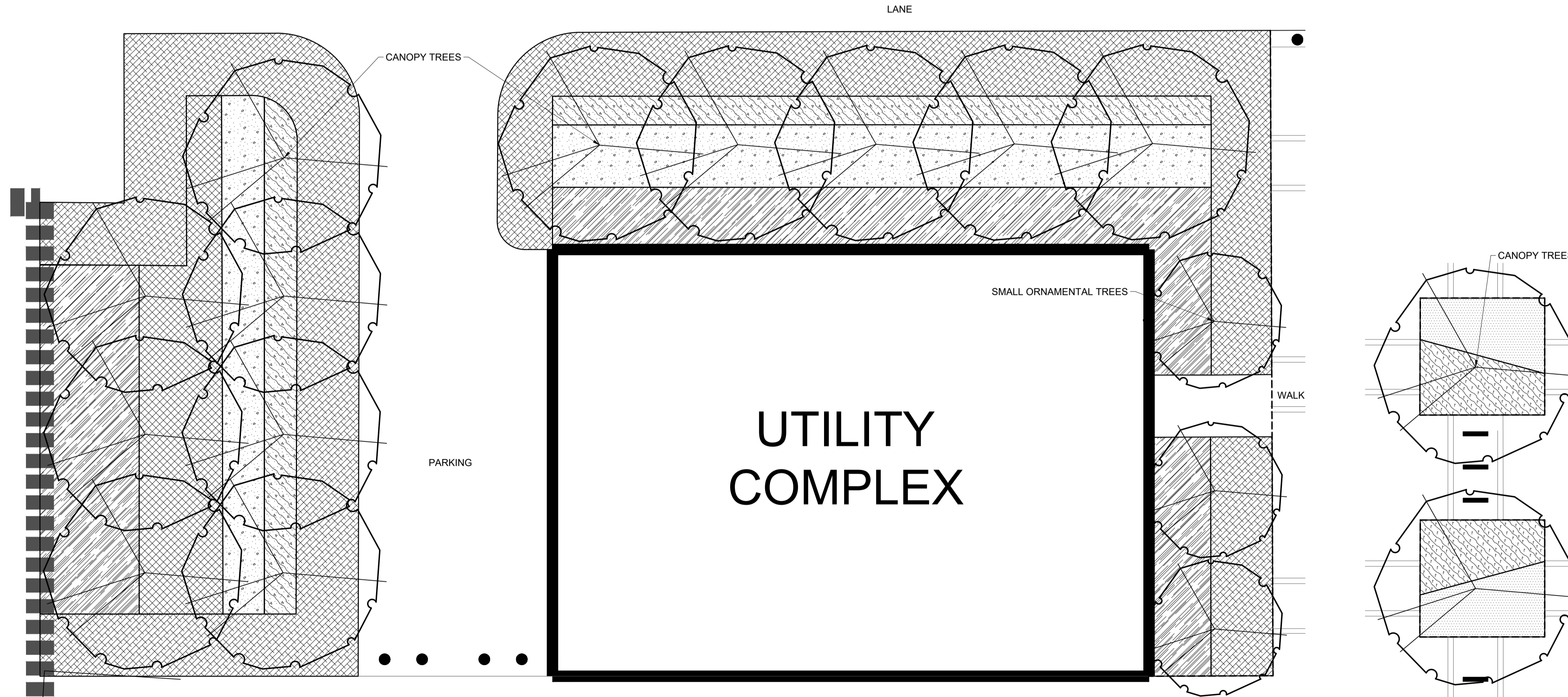

b PLANTING ENLARGEMENT
PLAN SCALE 1:100

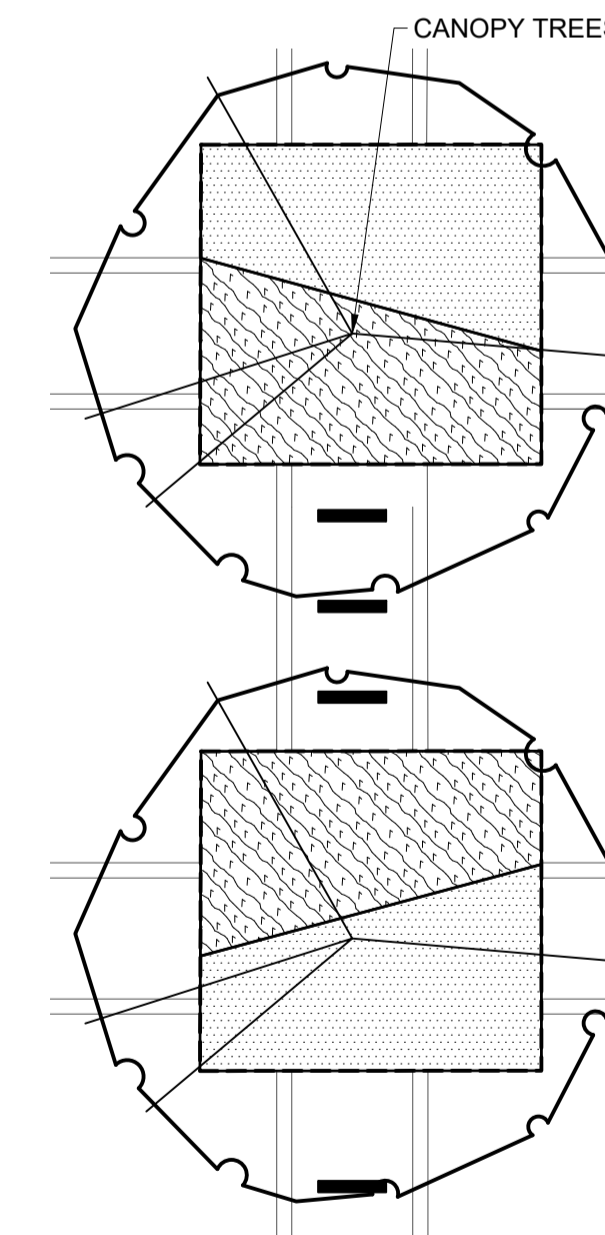

c PLANTING ENLARGEMENT
PLAN SCALE 1:100

J:\JOHNSON\September 15, 2020\G:\PROJECTS\140001480014854_VALLEY_LINE_LRT_WEST_DESIGN_CHEU2_CADD\20_DRAFTING\2200_LANDSCAPE\0411_02_LOCAL\XREF\06_102_107_AND_SPPV\LW-DB-0411-102_107_AND_SPPV_PLANTING_LAYOUT.DWG

VALLEY LINE WEST LRT

no.	description	date	checked
3	ISSUED FOR PA V4	18-9-2020	J.S.
2	ISSUED FOR PA V3	23-7-2020	J.S.
1	ISSUED FOR PA V1R	14-2-2020	B.D.
	revisions		

NOT FOR CONSTRUCTION



LANDSCAPE
STREETSCAPE DESIGN
156 STREET

DRAWING NO: 5-2B-13

J:\JOHNSON / September 15, 2020 / G:\PROJECTS\14000148001\4854 VALLEY LINE LRT WEST DESIGN_CAD\200_DRAFTING\200_LANDSCAPE\0411_02_107 AND SPR PLANTING LAYOUT.DWG

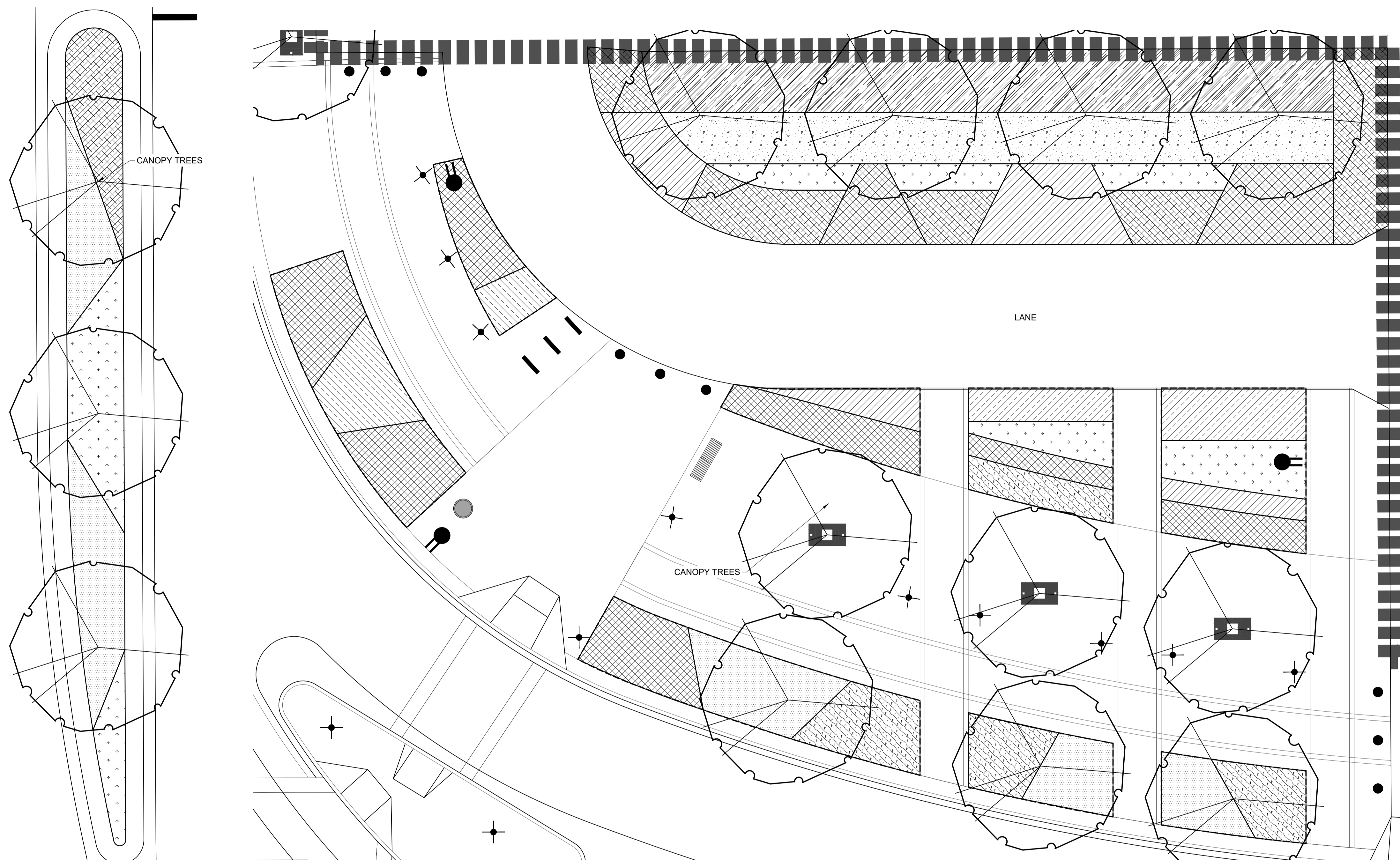
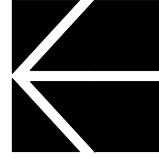

PLANT SCHEDULE JASPER PLACE

SHRUB AREAS	CODE	BOTANICAL NAME	COMMON NAME
	Br	Berberis thunbergii 'Rose Glow'	Rosy Glow Barberry
	Bt	Berberis x 'Tara' TM	Emerald Carousel Barberry
	Bc	Bergenia cordifolia	Heartleaf Bergenia
	Fg	Festuca glauca	Blue Fescue
	Ho	Hemerocallis x 'Stella de Oro'	Stella de Oro Daylily
	Jb	Juniperus horizontalis 'Blue Prince'	Blue Prince Juniper
	Ps	Panicum virgatum 'Shenandoah'	Switch Grass
	Pd	Physocarpus opulifolius 'Diabolo'	Diablo Ninebark
	Pa	Potentilla fruticosa 'Abbotswood'	Abbotswood Potentilla
	Sa	Spiraea x arguta 'Compacta'	Dwarf Garland Spirea
	Vn	Viburnum opulus 'Nanum'	Dwarf European Cranberry
	Turf		
			Lands Boundary

DRAWINGS ARE REPRESENTATIVE OF THE ANTICIPATED FINAL OUTCOME AND ARE NOT INTENDED FOR CONSTRUCTION

a PLANTING ENLARGEMENT
PLAN SCALE 1:100

b PLANTING ENLARGEMENT
PLAN SCALE 1:100

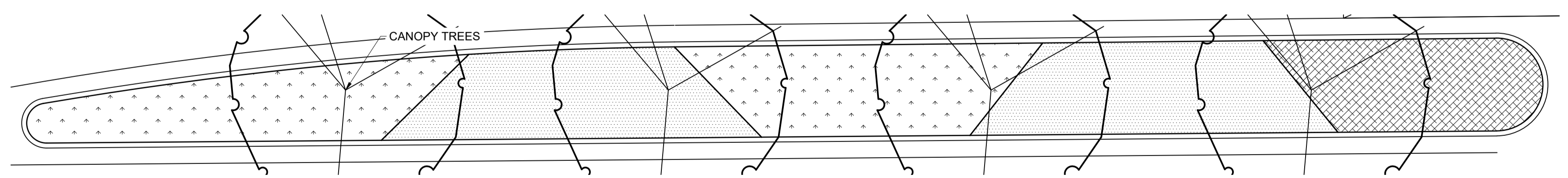

c PLANTING ENLARGEMENT
PLAN SCALE 1:100

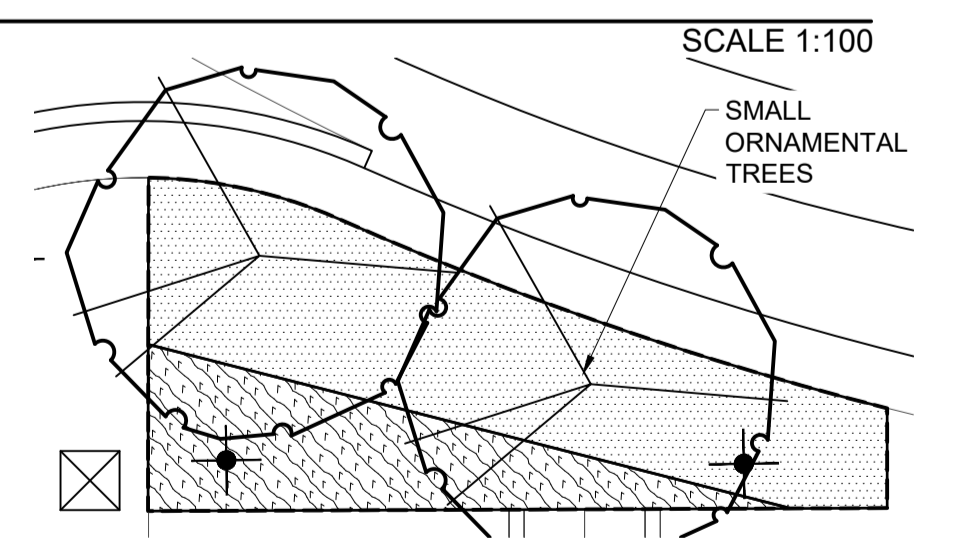

4 PLANTING ENLARGEMENT
PLAN SCALE 1:100

no.	description	date	checked
3	ISSUED FOR PA V4	18-9-2020	J.S.
2	ISSUED FOR PA V3	23-7-2020	J.S.
1	ISSUED FOR PA V1R	14-2-2020	B.D.
	revisions		

NOT FOR CONSTRUCTION



LANDSCAPE
STREETSCAPE DESIGN
STONY PLAIN ROAD & 156 STREET
DRAWING NO: 5-2B-14

VALLEY LINE WEST LRT

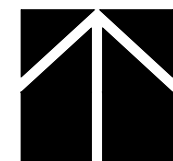

DRAWINGS ARE REPRESENTATIVE OF THE ANTICIPATED FINAL OUTCOME AND ARE NOT INTENDED FOR CONSTRUCTION

PLANT SCHEDULE JASPER PLACE

SHRUB AREAS	CODE	BOTANICAL NAME	COMMON NAME
	Br	Berberis thunbergii 'Rose Glow'	Rosy Glow Barberry
	Bt	Berberis x 'Tara' TM	Emerald Carousel Barberry
	Bc	Bergenia cordifolia	Heartleaf Bergenia
	Fg	Festuca glauca	Blue Fescue
	Ho	Hemerocallis x 'Stella de Oro'	Stella de Oro Daylily
	Jb	Juniperus horizontalis 'Blue Prince'	Blue Prince Juniper
	Ps	Panicum virgatum 'Shenandoah'	Switch Grass
	Pd	Physocarpus opulifolius 'Diabolo'	Diablo Ninebark
	Pa	Potentilla fruticosa 'Abbotswood'	Abbotswood Potentilla
	Sa	Spiraea x arguta 'Compacta'	Dwarf Garland Spirea
	Vn	Viburnum opulus 'Nanum'	Dwarf European Cranberry
		Turf	
		Lands Boundary	

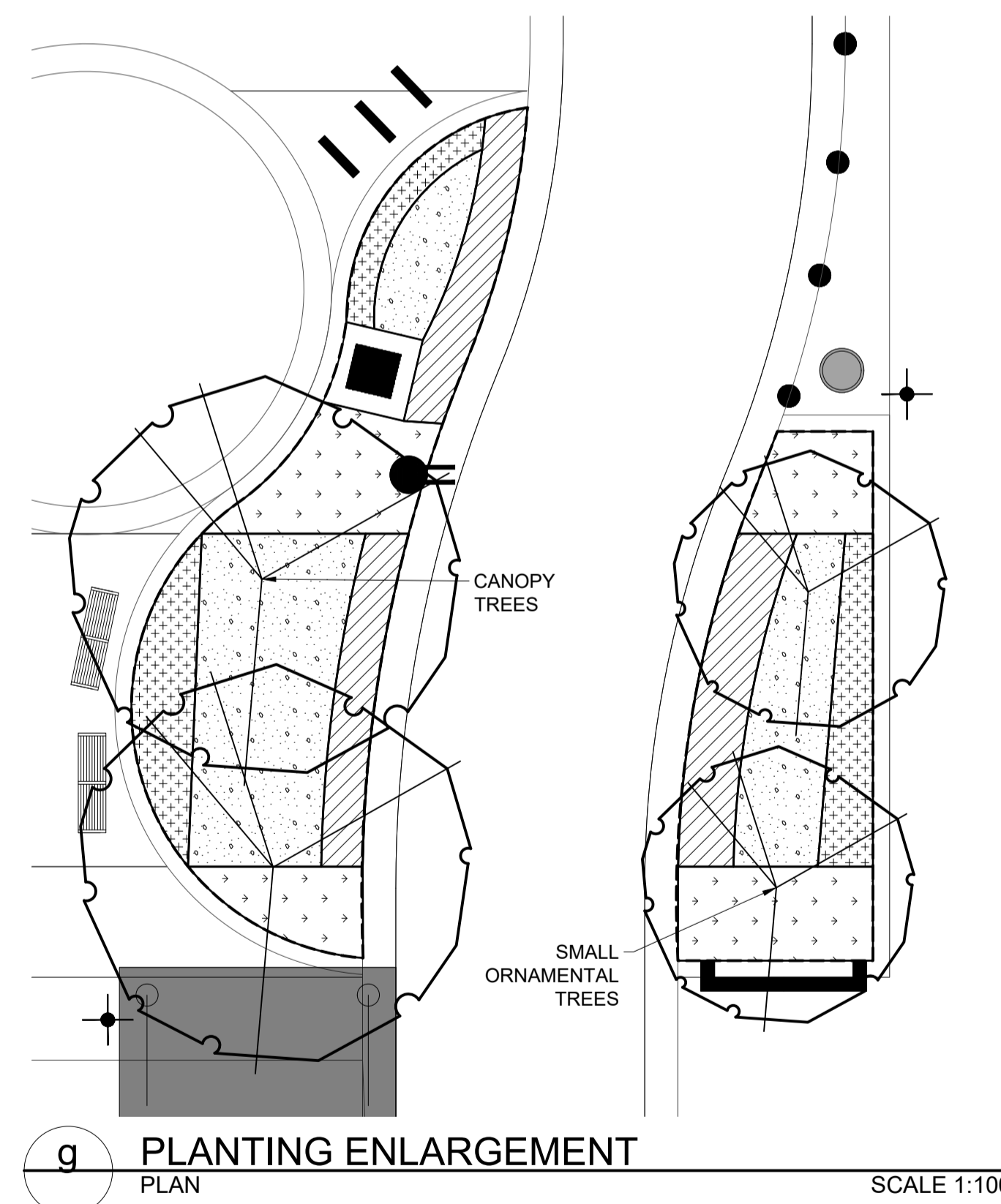
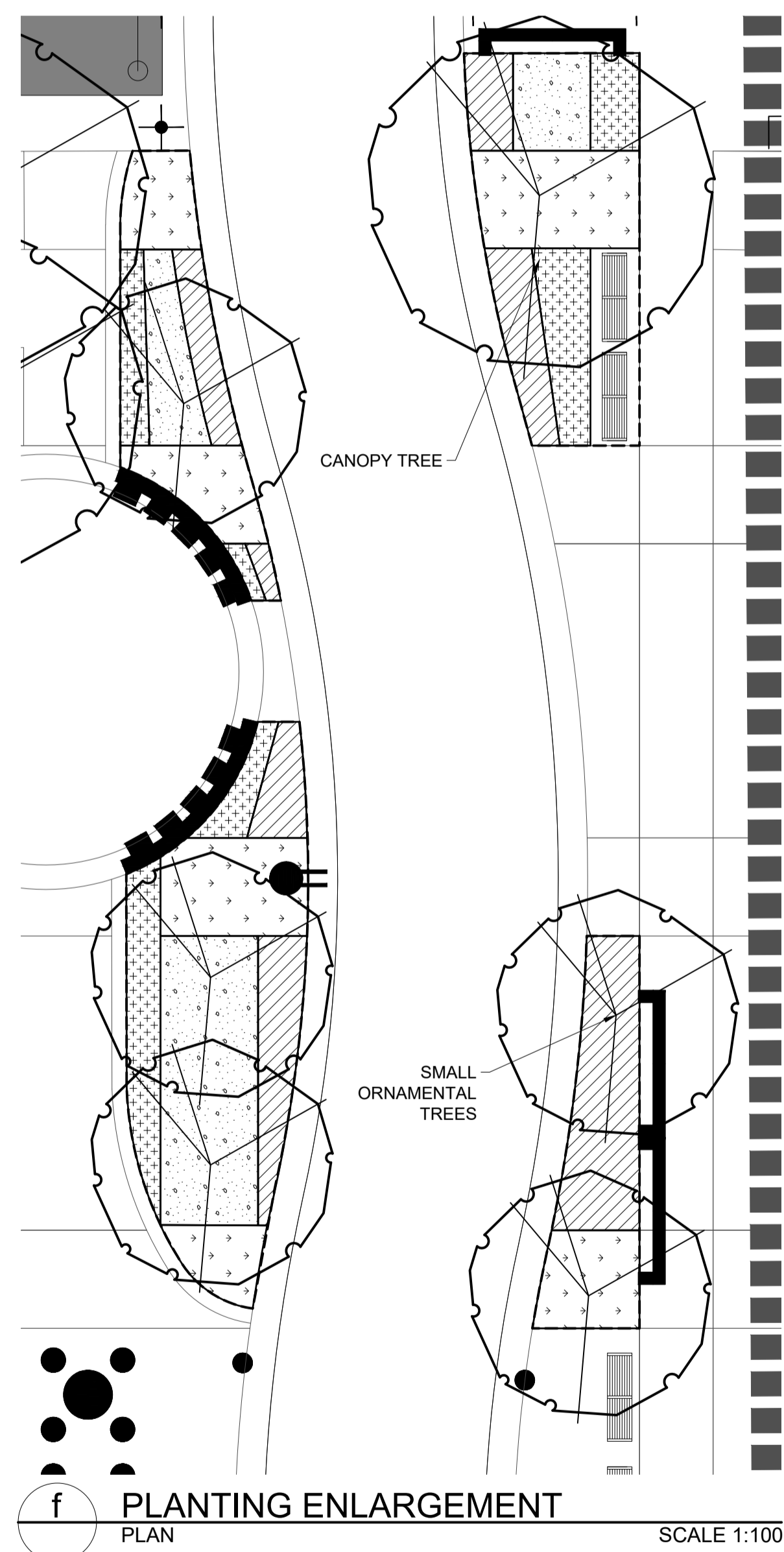
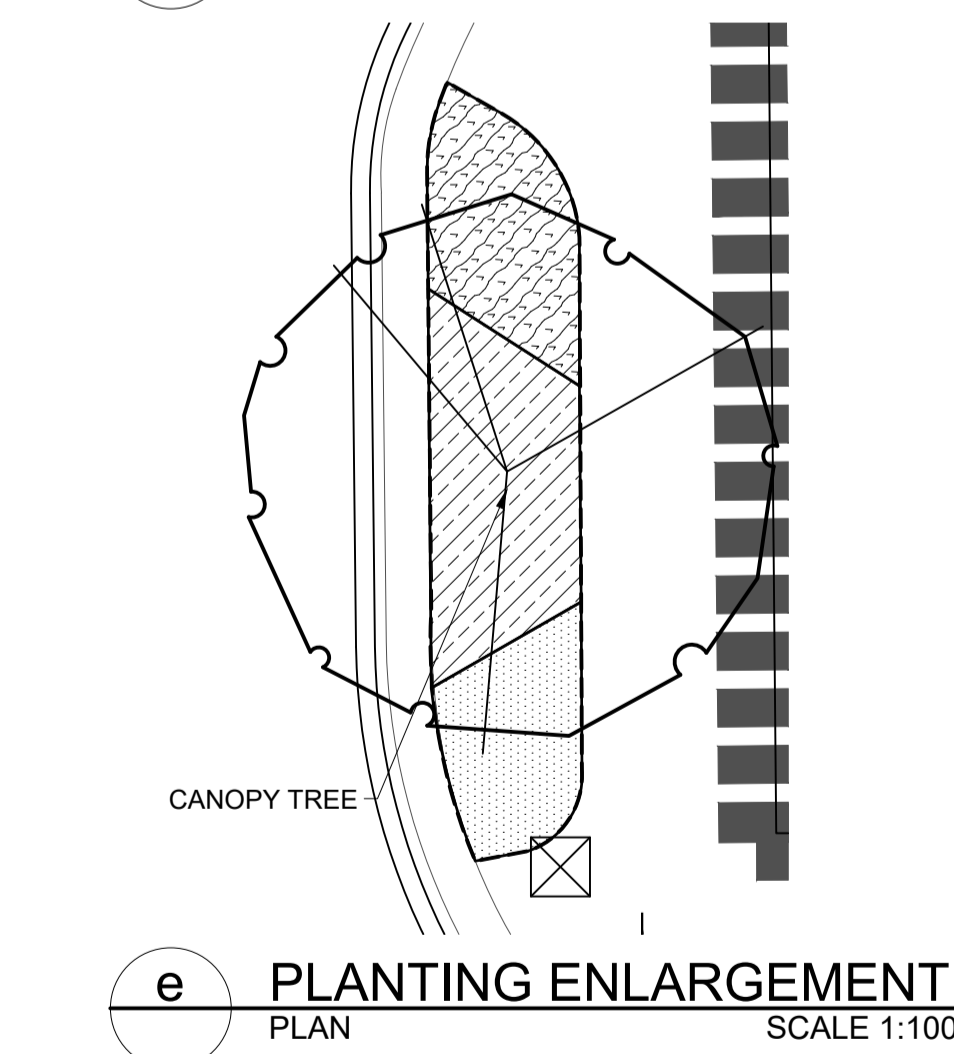
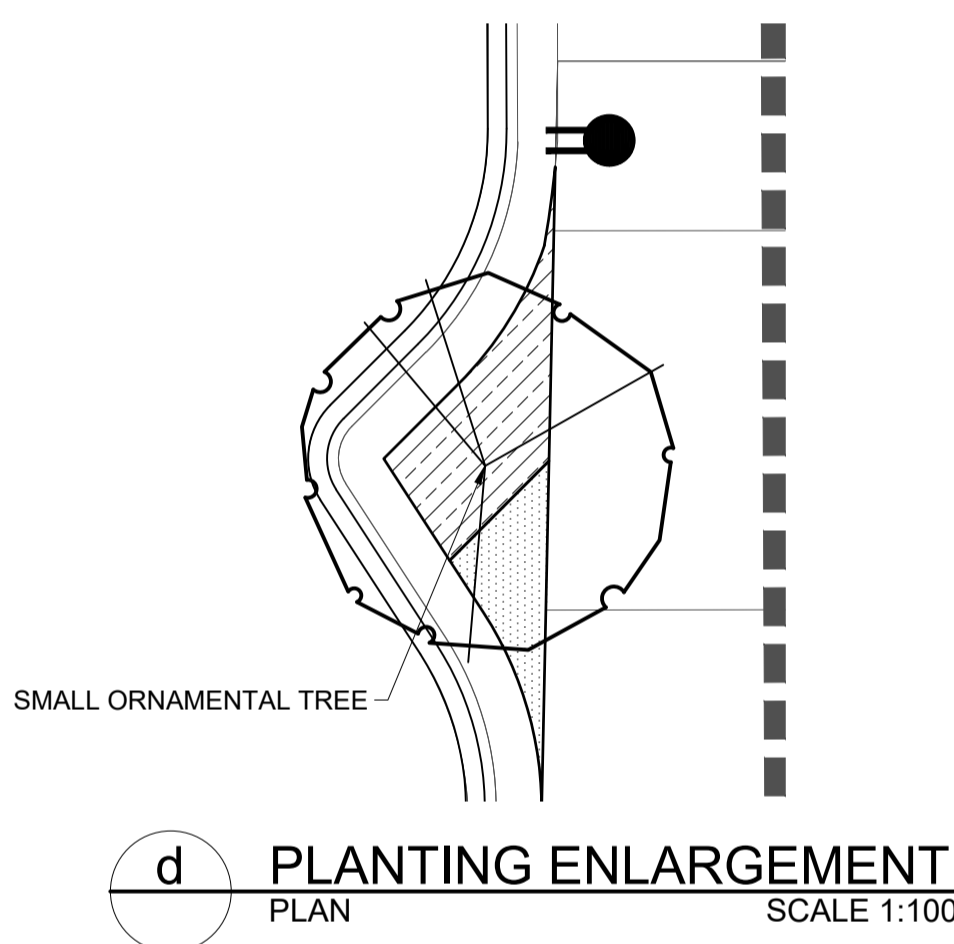
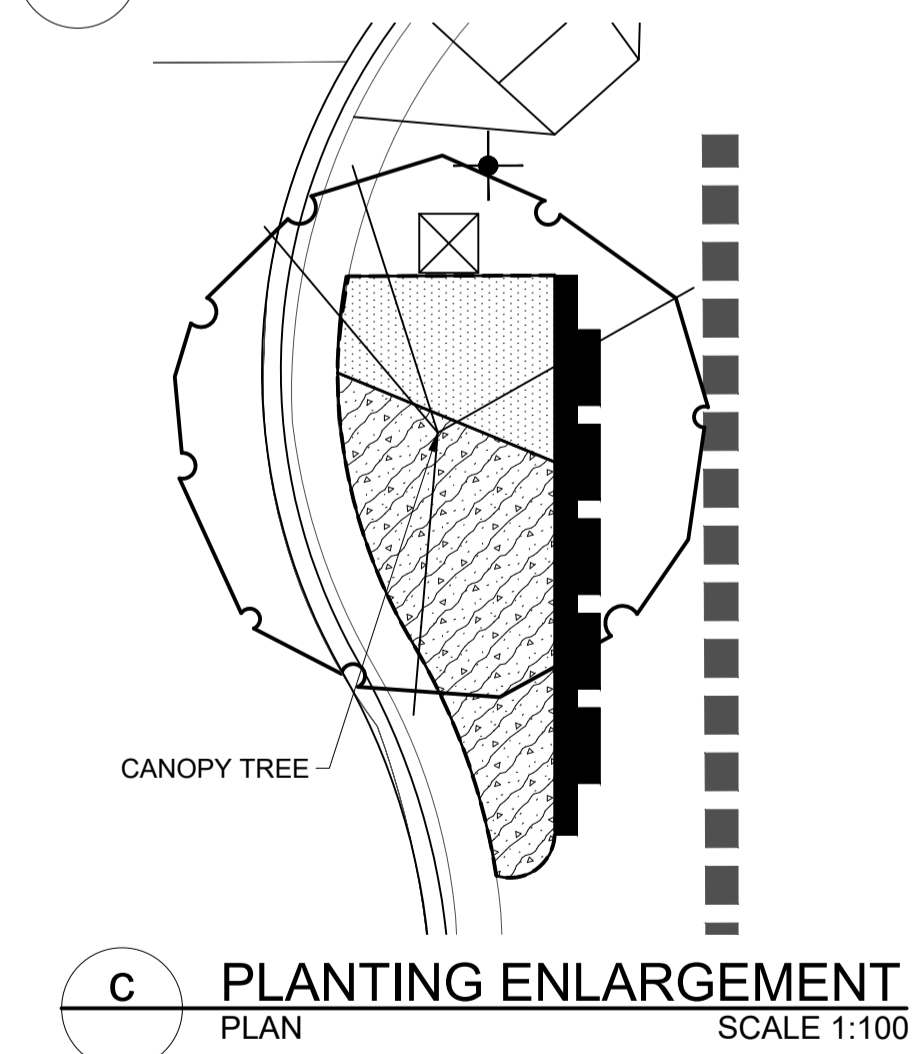
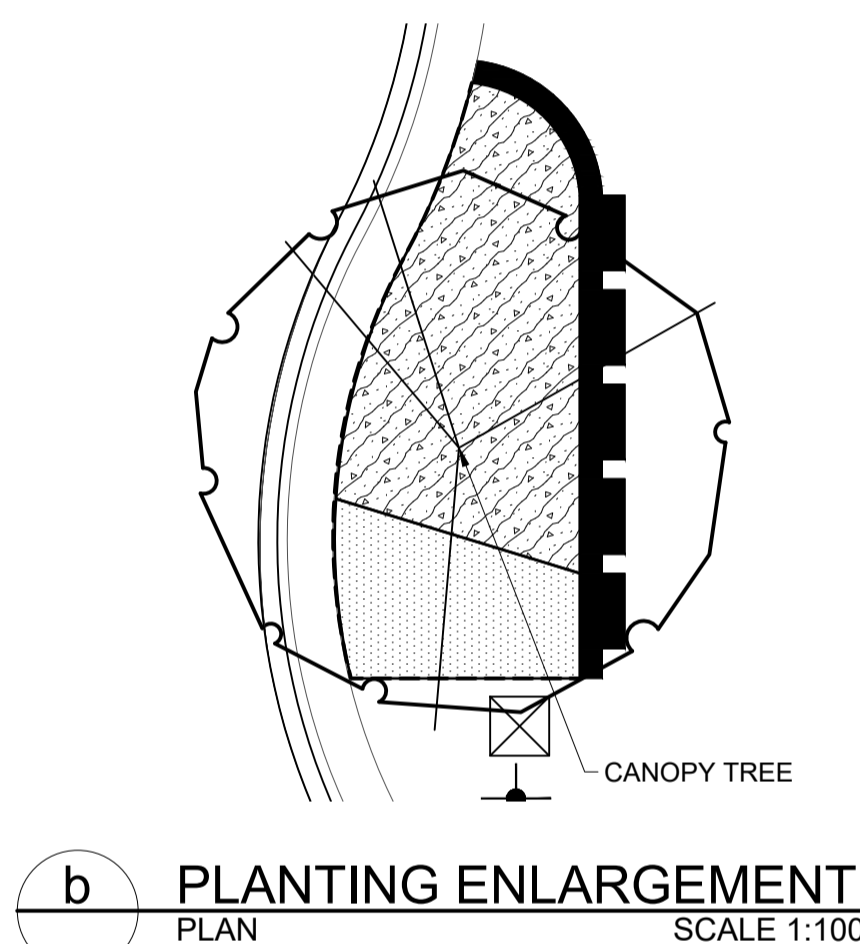
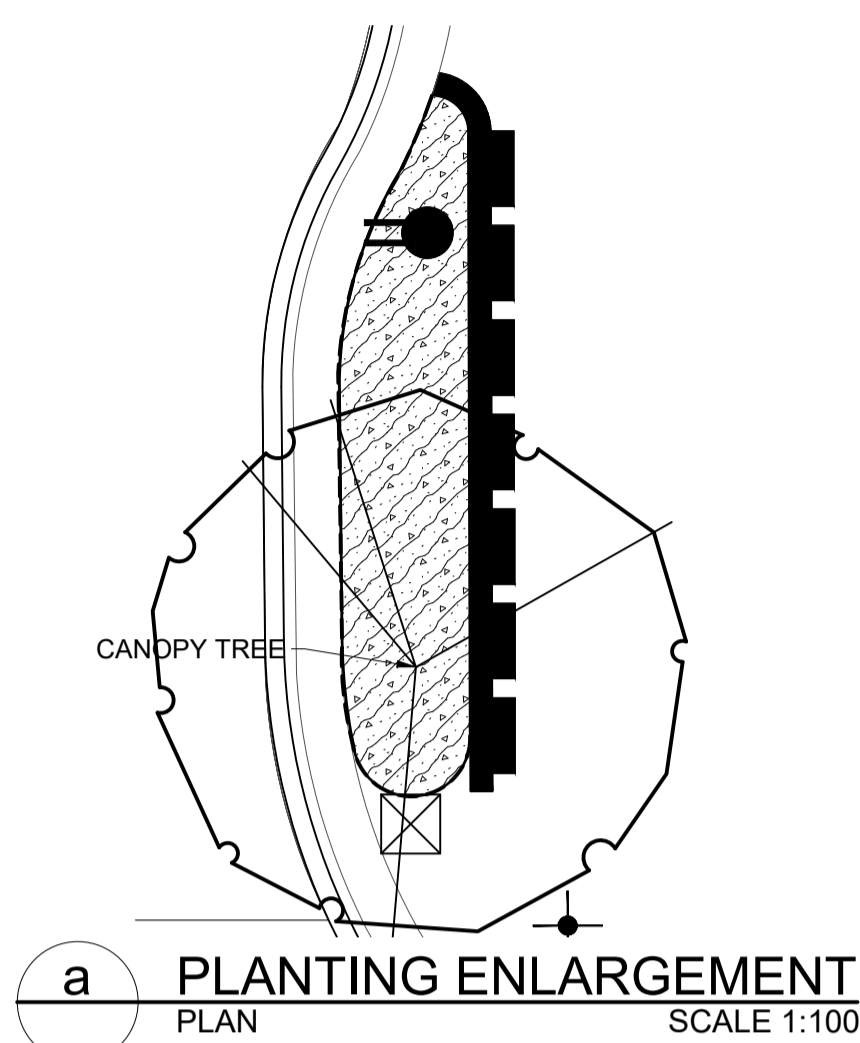

J:\JOHNSON\September 15, 2020\G:\PROJECTS\14000148001\4854_VALLEY_LINE_LRT_WEST_DESIGN_CIE\2_CADD\20_DRAFTING\2300_LANDSCAPE\0411_02_107_AND_SPRV\1\01-DB-0411-102_107_AND_SPRV\LANDSCAPE_LAYOUT.DWG

VALLEY LINE WEST LRT

no.	description	date	checked
3	ISSUED FOR PA V4	18-9-2020	J.S.
2	ISSUED FOR PA V3	23-7-2020	J.S.
1	ISSUED FOR PA V1R	14-2-2020	B.D.
	revisions		

NOT FOR CONSTRUCTION



LANDSCAPE
STREETSCAPE DESIGN
STONY PLAIN ROAD

DRAWING NO: 5-2B-15

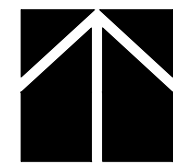

J:\JOHNSON\September 15, 2020\GIS\PROJECTS\140001480014854_VALLEY_LINE_LRT_WEST_DESIGN_CAD\20_DRAFTING\200_LANDSCAPE\041_00_LOCAL_XREF\06_102_107_AND_SPPRV\W-DB-0411-102_107_AND_SPPR_PLANTING_LAYOUT.DWG

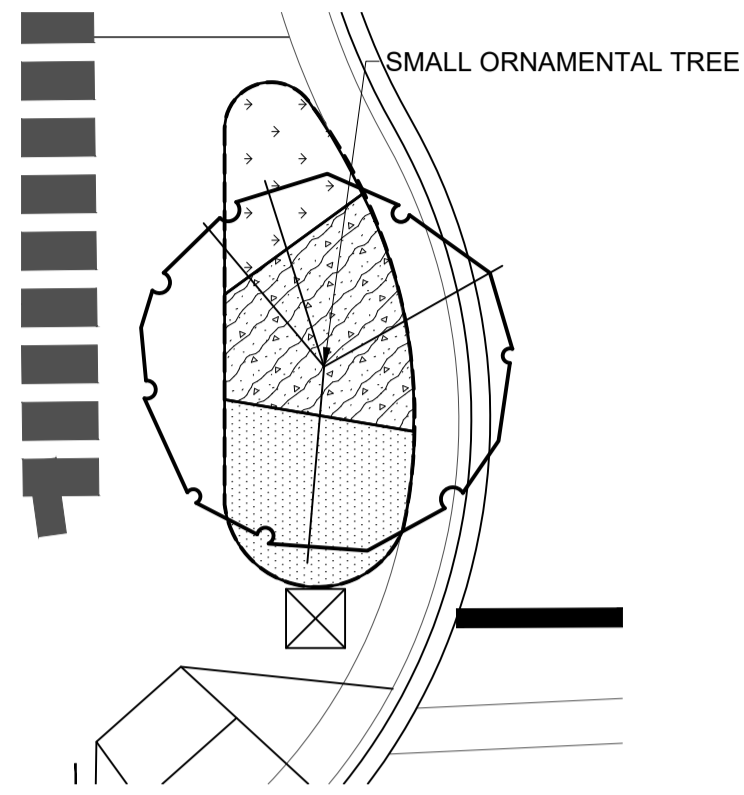

a PLANTING ENLARGEMENT
PLAN SCALE 1:100

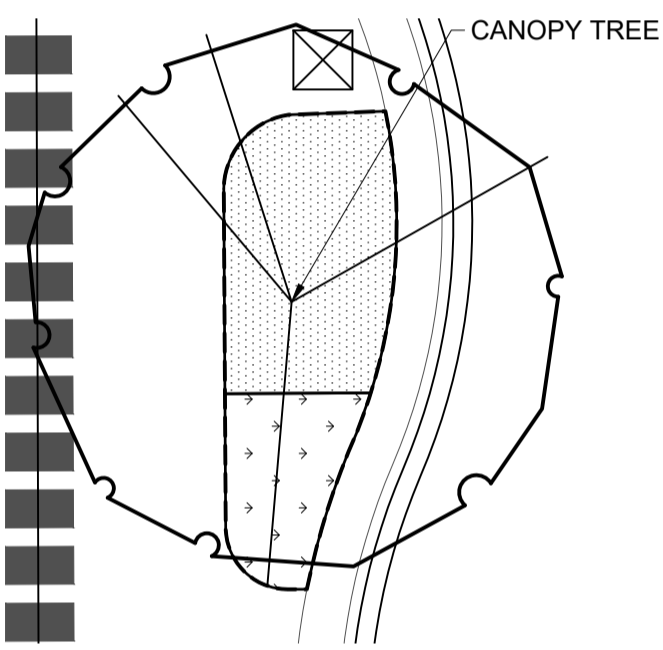

b PLANTING ENLARGEMENT
PLAN SCALE 1:100

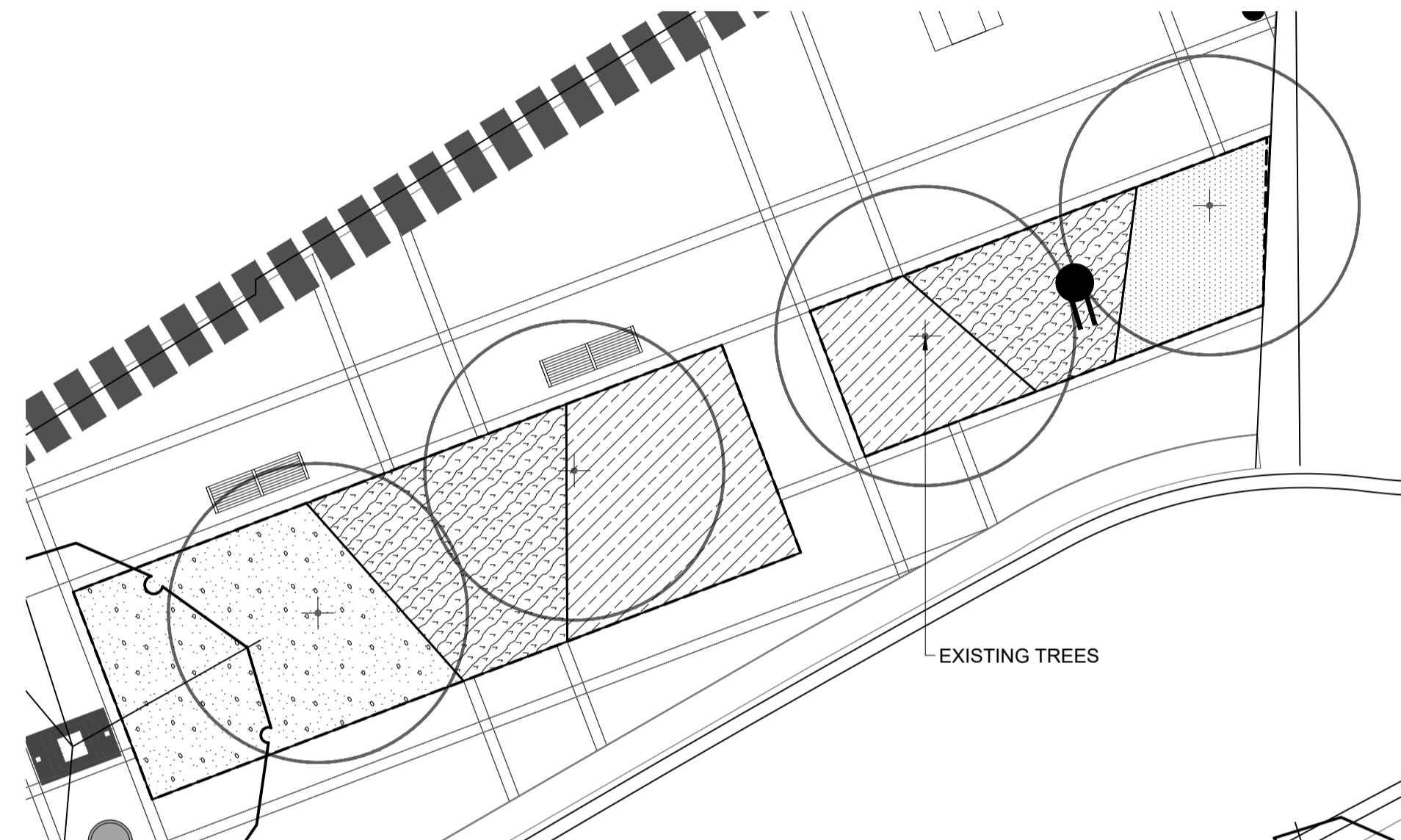

d PLANTING ENLARGEMENT
PLAN SCALE 1:100

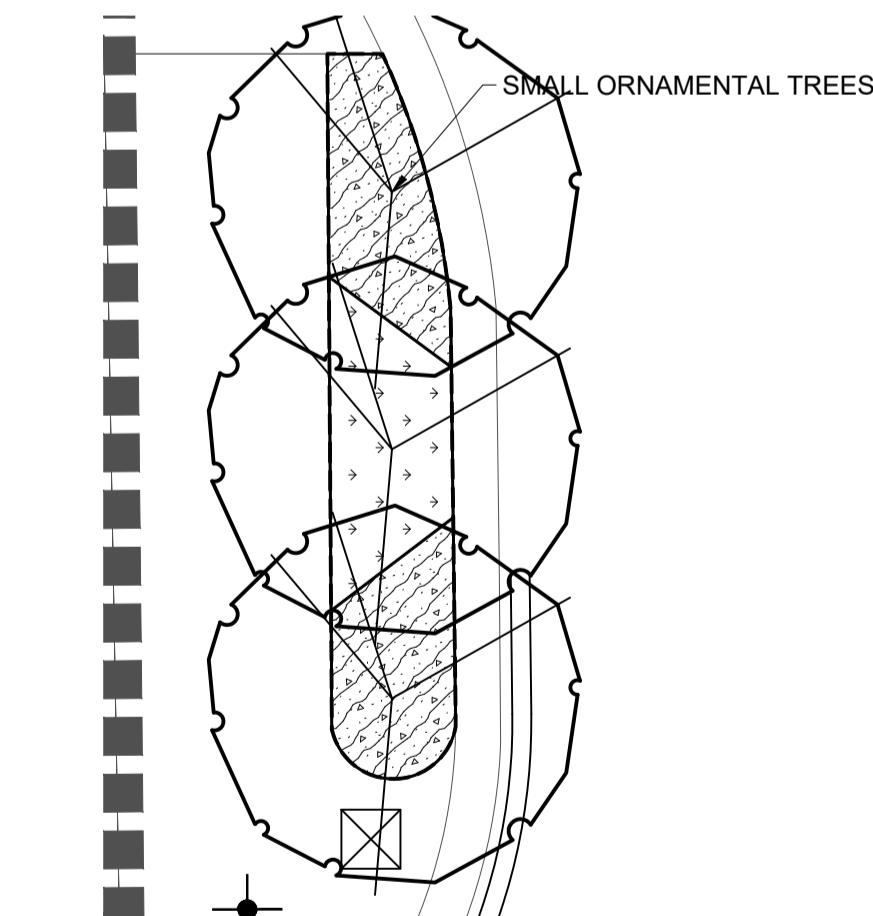

c PLANTING ENLARGEMENT
PLAN SCALE 1:100

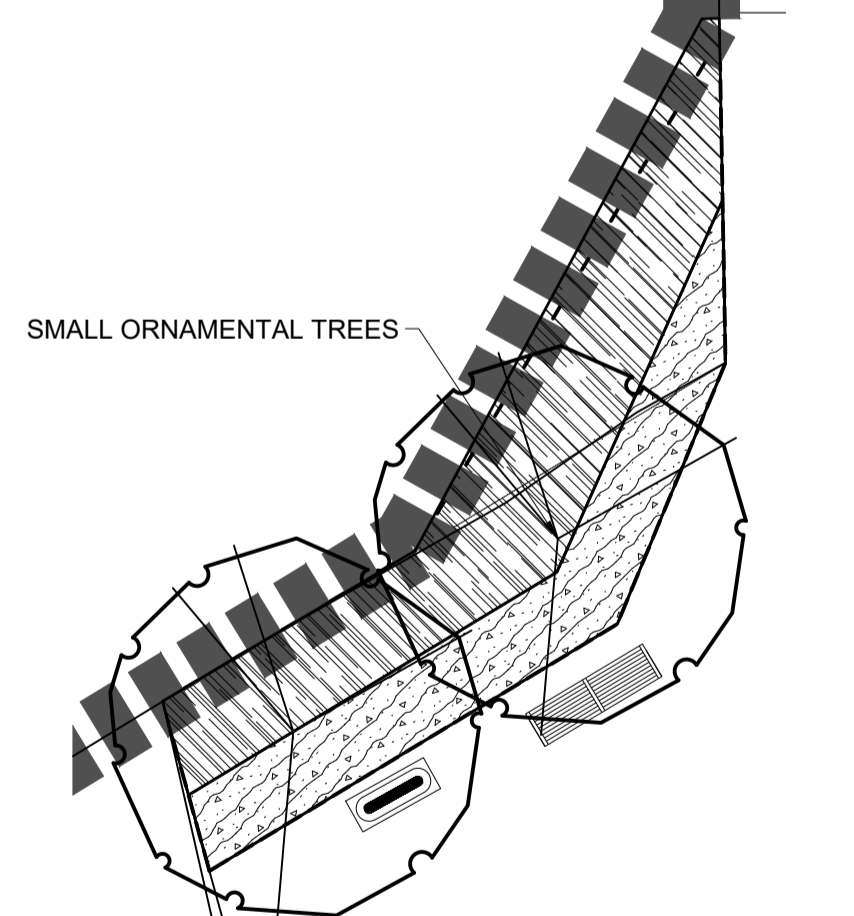

e PLANTING ENLARGEMENT
PLAN SCALE 1:100

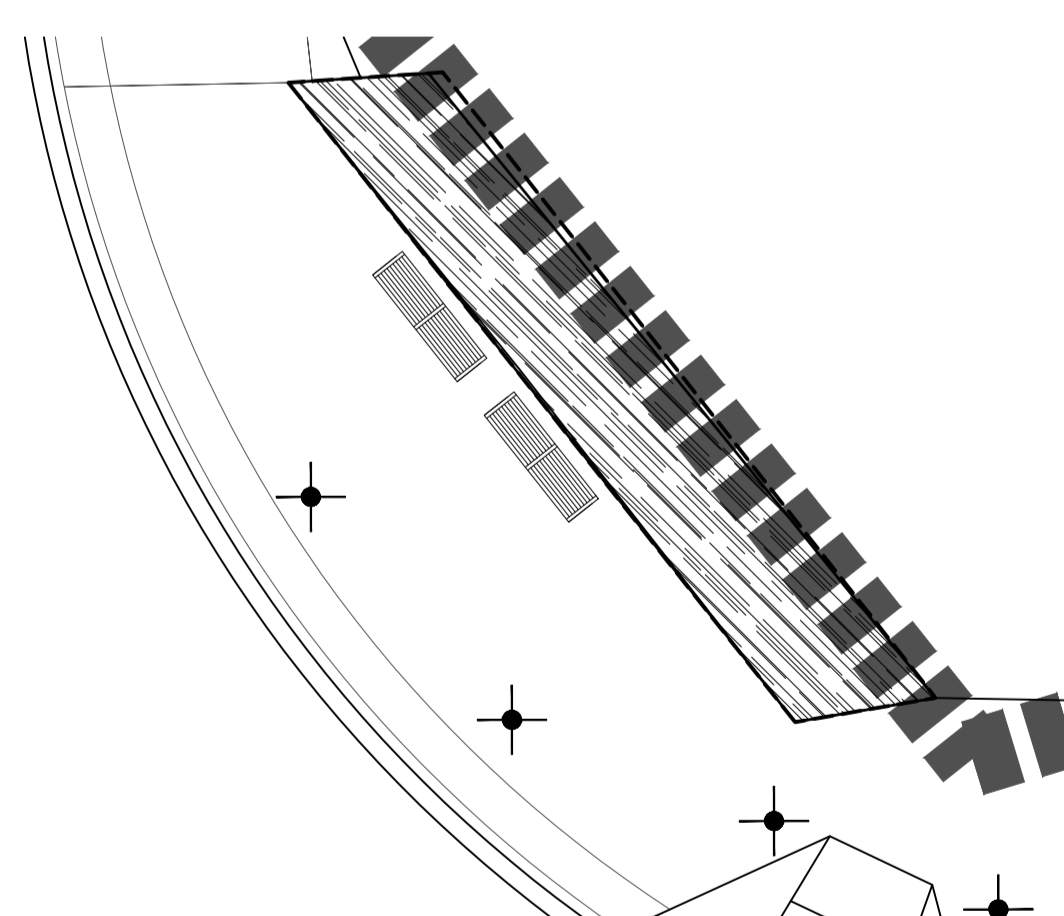

f PLANTING ENLARGEMENT
PLAN SCALE 1:100

PLANT SCHEDULE JASPER PLACE

SHRUB AREAS	CODE	BOTANICAL NAME	COMMON NAME
	Br	Berberis thunbergii 'Rose Glow'	Rosy Glow Barberry
	Bt	Berberis x 'Tara' TM	Emerald Carousel Barberry
	Bc	Bergenia cordifolia	Heartleaf Bergenia
	Fg	Festuca glauca	Blue Fescue
	Ho	Hemerocallis x 'Stella de Oro'	Stella de Oro Daylily
	Jb	Juniperus horizontalis 'Blue Prince'	Blue Prince Juniper
	Ps	Panicum virgatum 'Shenandoah'	Switch Grass
	Pd	Physocarpus opulifolius 'Diabolo'	Diablo Ninebark
	Pa	Potentilla fruticosa 'Abbotswood'	Abbotswood Potentilla
	Sa	Spiraea x arguta 'Compacta'	Dwarf Garland Spirea
	Vn	Viburnum opulus 'Nanum'	Dwarf European Cranberry
		Turf	
		Lands Boundary	

DRAWINGS ARE REPRESENTATIVE OF THE ANTICIPATED FINAL OUTCOME AND ARE NOT INTENDED FOR CONSTRUCTION

VALLEY LINE WEST LRT

no.	description	date	checked
3	ISSUED FOR PA V4	18-9-2020	J.S.
2	ISSUED FOR PA V3	23-7-2020	J.S.
1	ISSUED FOR PA V1R	14-2-2020	B.D.
	revisions		

NOT FOR CONSTRUCTION



LANDSCAPE
STREETSCAPE DESIGN
STONY PLAIN ROAD

DRAWING NO: 5-2B-16

APPENDIX 2C

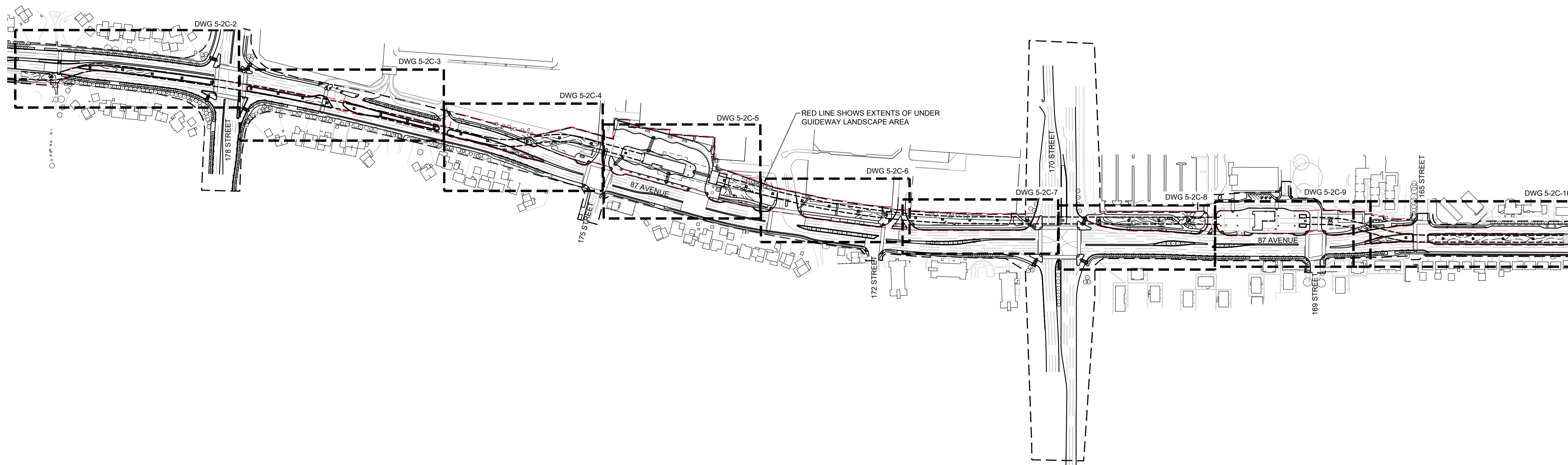
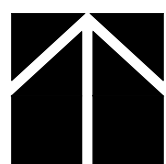

KEY PLAN

DRAWINGS ARE REPRESENTATIVE OF THE ANTICIPATED FINAL OUTCOME AND ARE NOT INTENDED FOR CONSTRUCTION

no.	description	date	checked
3	ISSUED FOR PA V4	18-09-20	J.S.
2	ISSUED FOR PA V3	23-07-20	J.S.
1	ISSUED FOR PA V1	01-05-20	B.D.
	revisions		

HORZ 0 25 50 75 100m
1:2500

NOT FOR CONSTRUCTION

AECOM
Prime Consultant

Edmonton

HATCH

DIALOG

ISL Engineering and Land Services

M
MOTT
MACDONALD

LANDSCAPE STREETScape DESIGN UNDER GUIDEWAY LANDSCAPE AREA

DRAWING NO: 5-2C-1



B:\PROJECTS\1400014854_VALLEY_LINE_LRT_WEST_DESIGN_CADD\2020_DRAFTING\2020_LANDSCAPE\0411_00_LOCAL_XREF\17_UNDER GUIDEWAY LANDSCAPE AREA\4854_LG_LAND.DWG

MATCHLINE - REFER TO DRAWING 5-2C-2

MATCHLINE - REFER TO DRAWING 5-2C-3

MATCHLINE - REFER TO DRAWING 5-2C-4

MATCHLINE - REFER TO DRAWING 5-2C-3

VALLEY LINE WEST LRT

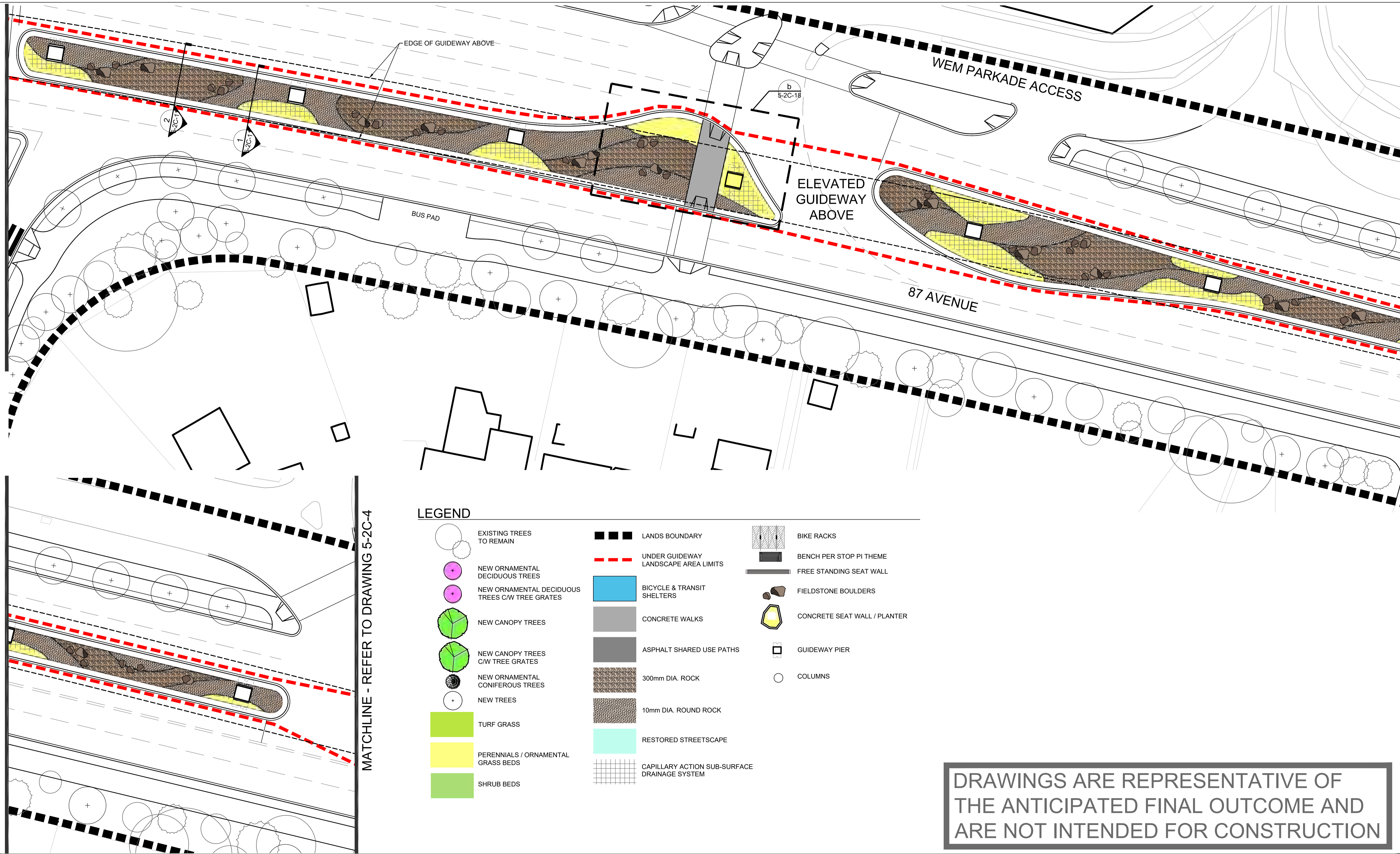

LEGEND

- EXISTING TREES TO REMAIN
- NEW ORNAMENTAL DECIDUOUS TREES
- NEW ORNAMENTAL DECIDUOUS TREES C/W TREE GRATES
- NEW CANOPY TREES
- NEW CANOPY TREES C/W TREE GRATES
- NEW ORNAMENTAL CONIFEROUS TREES
- NEW TREES
- TURF GRASS
- PERENNIALS / ORNAMENTAL GRASS BEDS
- SHRUB BEDS
- LANDS BOUNDARY
- UNDER GUIDEWAY LANDSCAPE AREA LIMITS
- BICYCLE & TRANSIT SHELTERS
- CONCRETE WALKS
- ASPHALT SHARED USE PATHS
- 300mm DIA. ROCK
- 10mm DIA. ROUND ROCK
- RESTORED STREETSCAPE
- CAPILLARY ACTION SUB-SURFACE DRAINAGE SYSTEM
- BIKE RACKS
- BENCH PER STOP PI THEME
- FREE STANDING SEAT WALL
- FIELDSTONE BOULDERS
- CONCRETE SEAT WALL / PLANTER
- GUIDEWAY PIER
- COLUMNS

DRAWINGS ARE REPRESENTATIVE OF THE ANTICIPATED FINAL OUTCOME AND ARE NOT INTENDED FOR CONSTRUCTION

no.	description	date	checked
3	ISSUED FOR PA V4	18-09-20	J.S.
2	ISSUED FOR PA V3	23-07-20	J.S.
1	ISSUED FOR PA V1	01-05-20	B.D.
revisions			

HORZO 2.5 5.0 7.5 10.0m
1:250

NOT FOR CONSTRUCTION

AECOM
Prime Consultant

Edmonton

HATCH

DIALOG

ISL Engineering
and Land Services

M M
MOTT
MACDONALD

LANDSCAPE
UNDER GUIDEWAY LANDSCAPE AREA

DRAWING NO: 5-2C-3



DRAWINGS ARE REPRESENTATIVE OF THE ANTICIPATED FINAL OUTCOME AND ARE NOT INTENDED FOR CONSTRUCTION

MATCHLINE - REFER TO DRAWING 5-2C-3

MATCHLINE - REFER TO DRAWING 5-2C-5

VALLEY LINE WEST LRT

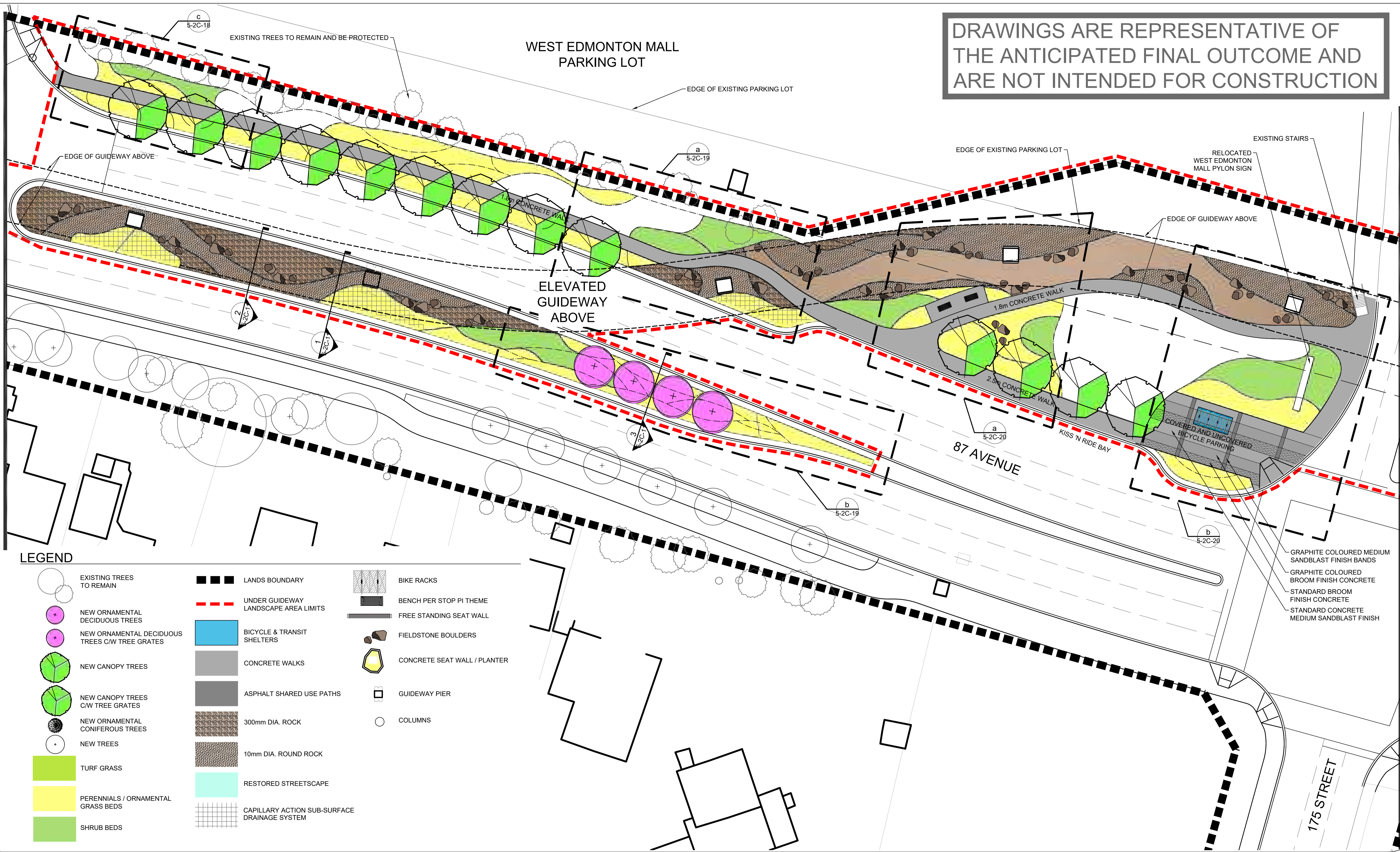

LEGEND

- EXISTING TREES TO REMAIN
- NEW ORNAMENTAL DECIDUOUS TREES
- NEW ORNAMENTAL DECIDUOUS TREES C/W TREE GRATES
- NEW CANOPY TREES
- NEW CANOPY TREES C/W TREE GRATES
- NEW ORNAMENTAL CONIFEROUS TREES
- NEW TREES
- TURF GRASS
- PERENNIALS / ORNAMENTAL GRASS BEDS
- SHRUB BEDS
- LANDS BOUNDARY
- UNDER GUIDEWAY LANDSCAPE AREA LIMITS
- BICYCLE & TRANSIT SHELTERS
- CONCRETE WALKS
- ASPHALT SHARED USE PATHS
- 300mm DIA. ROCK
- 10mm DIA. ROUND ROCK
- RESTORED STREETSCAPE
- CAPILLARY ACTION SUB-SURFACE DRAINAGE SYSTEM
- BIKE RACKS
- BENCH PER STOP PI THEME
- FREE STANDING SEAT WALL
- FIELDSTONE BOULDERS
- CONCRETE SEAT WALL / PLANTER
- GUIDEWAY PIER
- COLUMNS

no.	description	date	checked
3	ISSUED FOR PA V4	18-09-20	J.S.
2	ISSUED FOR PA V3	23-07-20	J.S.
1	ISSUED FOR PA V1	01-05-20	B.D.
	revisions		

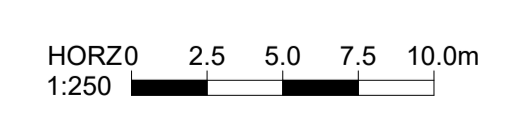

NOT FOR CONSTRUCTION



LANDSCAPE UNDER GUIDEWAY LANDSCAPE AREA
DRAWING NO: 5-2C-4

B:\DWG\2014\September 14, 2020\G:\PROJECTS\1400014854\VALLEY_LINE_LRT_WEST_DESIGN_C6202_CADD\20_DRAFTING\2020_LANDSCAPE\0411_00_LOCAL_XREF\17_UNDER GUIDEWAY LANDSCAPE AREA\4854_LUG_LAND.DWG



DRAWINGS ARE REPRESENTATIVE OF THE ANTICIPATED FINAL OUTCOME AND ARE NOT INTENDED FOR CONSTRUCTION

- LEGEND**
- EXISTING TREES TO REMAIN
 - NEW ORNAMENTAL DECIDUOUS TREES
 - NEW ORNAMENTAL DECIDUOUS TREES C/W TREE GRATES
 - NEW CANOPY TREES
 - NEW CANOPY TREES C/W TREE GRATES
 - NEW ORNAMENTAL CONIFEROUS TREES
 - NEW TREES
 - TURF GRASS
 - PERENNIALS / ORNAMENTAL GRASS BEDS
 - SHRUB BEDS
 - LANDS BOUNDARY
 - UNDER GUIDEWAY LANDSCAPE AREA LIMITS
 - BICYCLE & TRANSIT SHELTERS
 - CONCRETE WALKS
 - ASPHALT SHARED USE PATHS
 - 300mm DIA. ROCK
 - 10mm DIA. ROUND ROCK
 - RESTORED STREETSCAPE
 - CAPILLARY ACTION SUB-SURFACE DRAINAGE SYSTEM
 - BIKE RACKS
 - BENCH PER STOP PI THEME
 - FREE STANDING SEAT WALL
 - FIELDSTONE BOULDERS
 - CONCRETE SEAT WALL / PLANTER
 - GUIDEWAY PIER
 - COLUMNS

MATCHLINE - REFER TO DRAWING 5-2C-4

MATCHLINE - REFER TO DRAWING 5-2C-6

VALLEY LINE WEST LRT

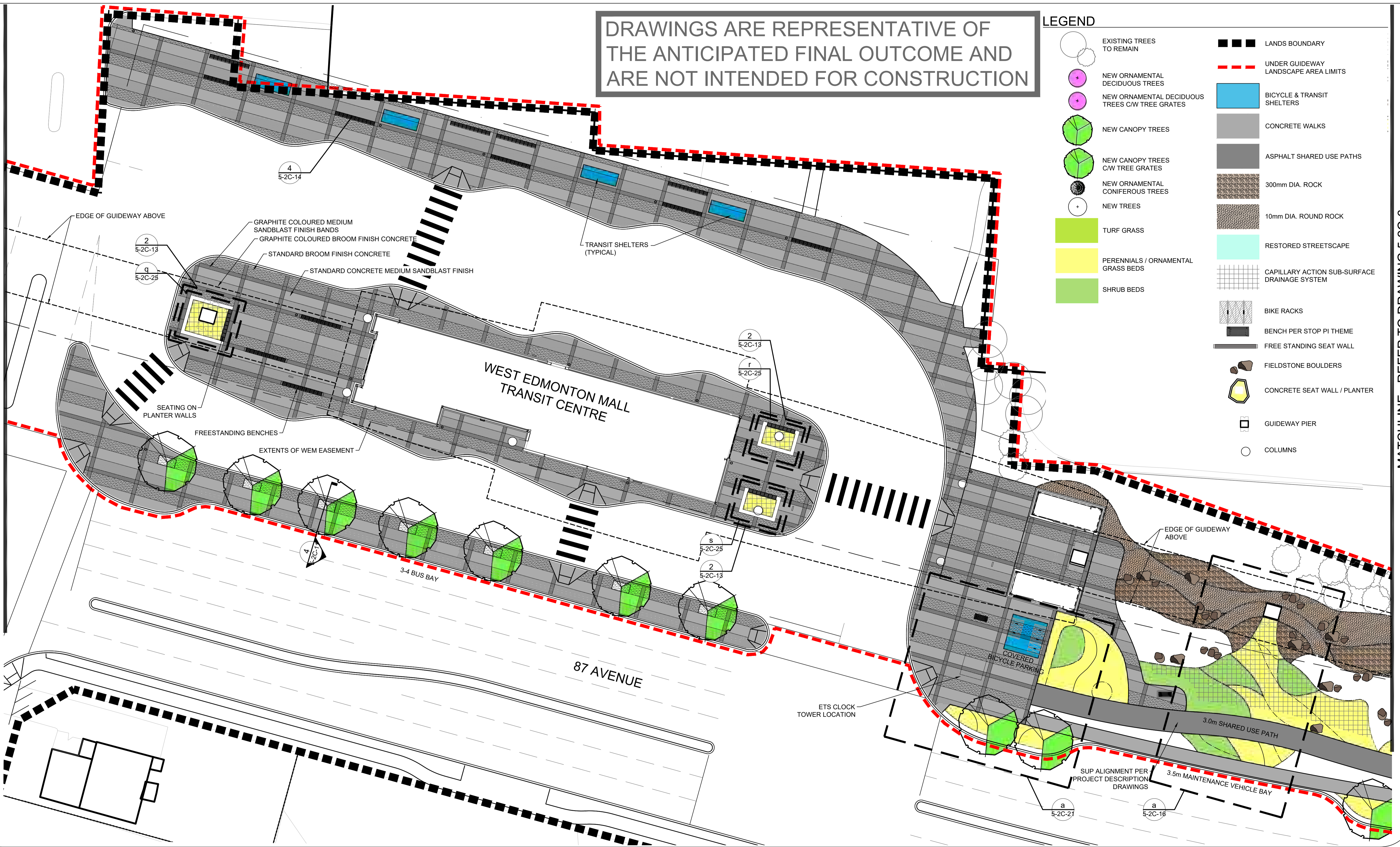

BDAVIDSON / September 14, 2020 / G:\PROJECTS\140001\48001\4854_VALLEY_LINE_LRT_WEST_LANDSCAPE\0411_00_LOCAL_XREF\17_UNDERGUIDEWAY_LANDSCAPE\AREA\4854_LG_LAND.DWG

no.	description	date	checked
3	ISSUED FOR PA V4	18-09-20	J.S.
2	ISSUED FOR PA V3	23-07-20	J.S.
1	ISSUED FOR PA V1	01-05-20	B.D.
revisions			

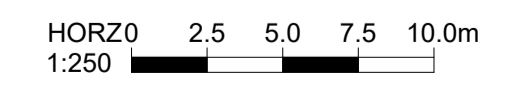

NOT FOR CONSTRUCTION

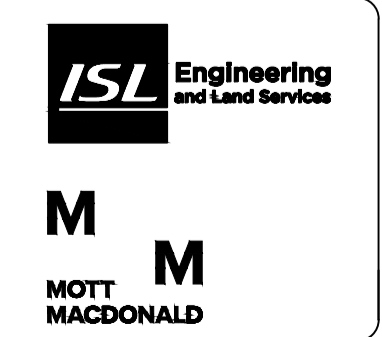

LANDSCAPE UNDER GUIDEWAY LANDSCAPE AREA

DRAWING NO: 5-2C-5



B:\DWG\DWG\14_2020\G:\PROJECTS\140001\48001\4854_VALLEY_LINE_LRT_WEST_DESIGN_06202_CADD\20_LANDSCAPE\200_LANDSCAPE\041_00_LOCAL_XREF\17_UNDER GUIDEWAY LANDSCAPE AREA\4854_LG_LAND.DWG

MATCHLINE - REFER TO DRAWING 5-2C-5

MATCHLINE - REFER TO DRAWING 5-2C-7

VALLEY LINE WEST LRT

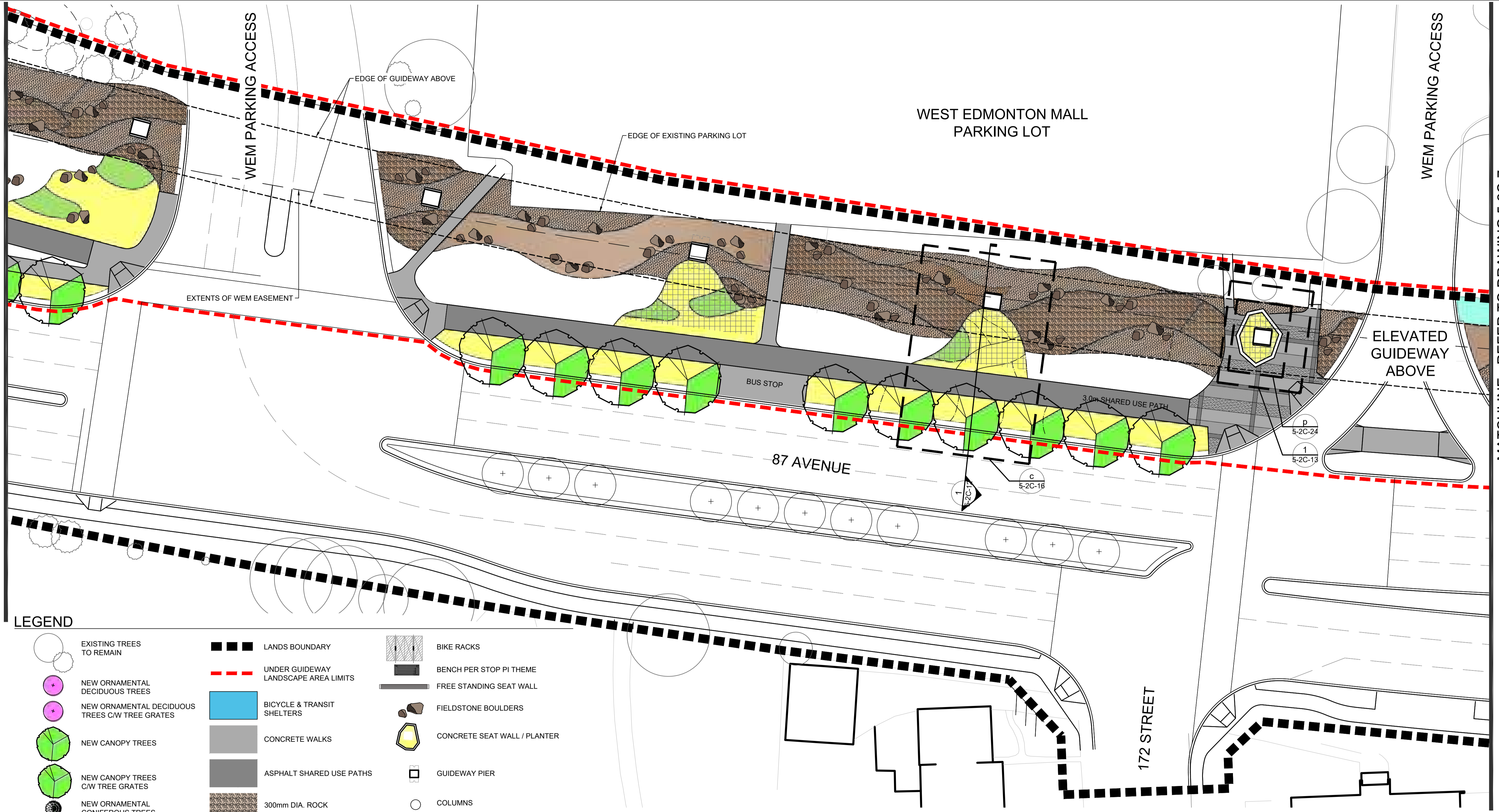

LEGEND

- EXISTING TREES TO REMAIN
- NEW ORNAMENTAL DECIDUOUS TREES
- NEW ORNAMENTAL DECIDUOUS TREES C/W TREE GRATES
- NEW CANOPY TREES
- NEW CANOPY TREES C/W TREE GRATES
- NEW ORNAMENTAL CONIFEROUS TREES
- NEW TREES
- TURF GRASS
- PERENNIALS / ORNAMENTAL GRASS BEDS
- SHRUB BEDS
- LANDS BOUNDARY
- UNDER GUIDEWAY LANDSCAPE AREA LIMITS
- BICYCLE & TRANSIT SHELTERS
- CONCRETE WALKS
- ASPHALT SHARED USE PATHS
- 300mm DIA. ROCK
- 10mm DIA. ROUND ROCK
- RESTORED STREETSCAPE
- CAPILLARY ACTION SUB-SURFACE DRAINAGE SYSTEM
- BIKE RACKS
- BENCH PER STOP PI THEME
- FREE STANDING SEAT WALL
- FIELDSTONE BOULDERS
- CONCRETE SEAT WALL / PLANTER
- GUIDEWAY PIER
- COLUMNS

DRAWINGS ARE REPRESENTATIVE OF THE ANTICIPATED FINAL OUTCOME AND ARE NOT INTENDED FOR CONSTRUCTION

no.	description	date	checked
3	ISSUED FOR PA V4	18-09-20	J.S.
2	ISSUED FOR PA V3	23-07-20	J.S.
1	ISSUED FOR PA V1	01-05-20	B.D.
revisions			

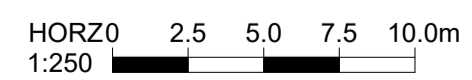

NOT FOR CONSTRUCTION



LANDSCAPE UNDER GUIDEWAY LANDSCAPE AREA

DRAWING NO: 5-2C-6



B:\DWG\2019\14\2020\G:\PROJECTS\140001\4801\4854_VALLEY_LINE_LRT_WEST_DESIGN_CADD\2020_DRAFTING\2020_LANDSCAPE\0411_00_LOCAL_XREF\17_UNDERGUIDEWAY_LANDSCAPEAREA\4854_LG_LAND.DWG

MATCHLINE - REFER TO DRAWING 5-2C-6

MATCHLINE - REFER TO DRAWING 5-2C-8

VALLEY LINE WEST LRT

WEST EDMONTON MALL PARKING LOT

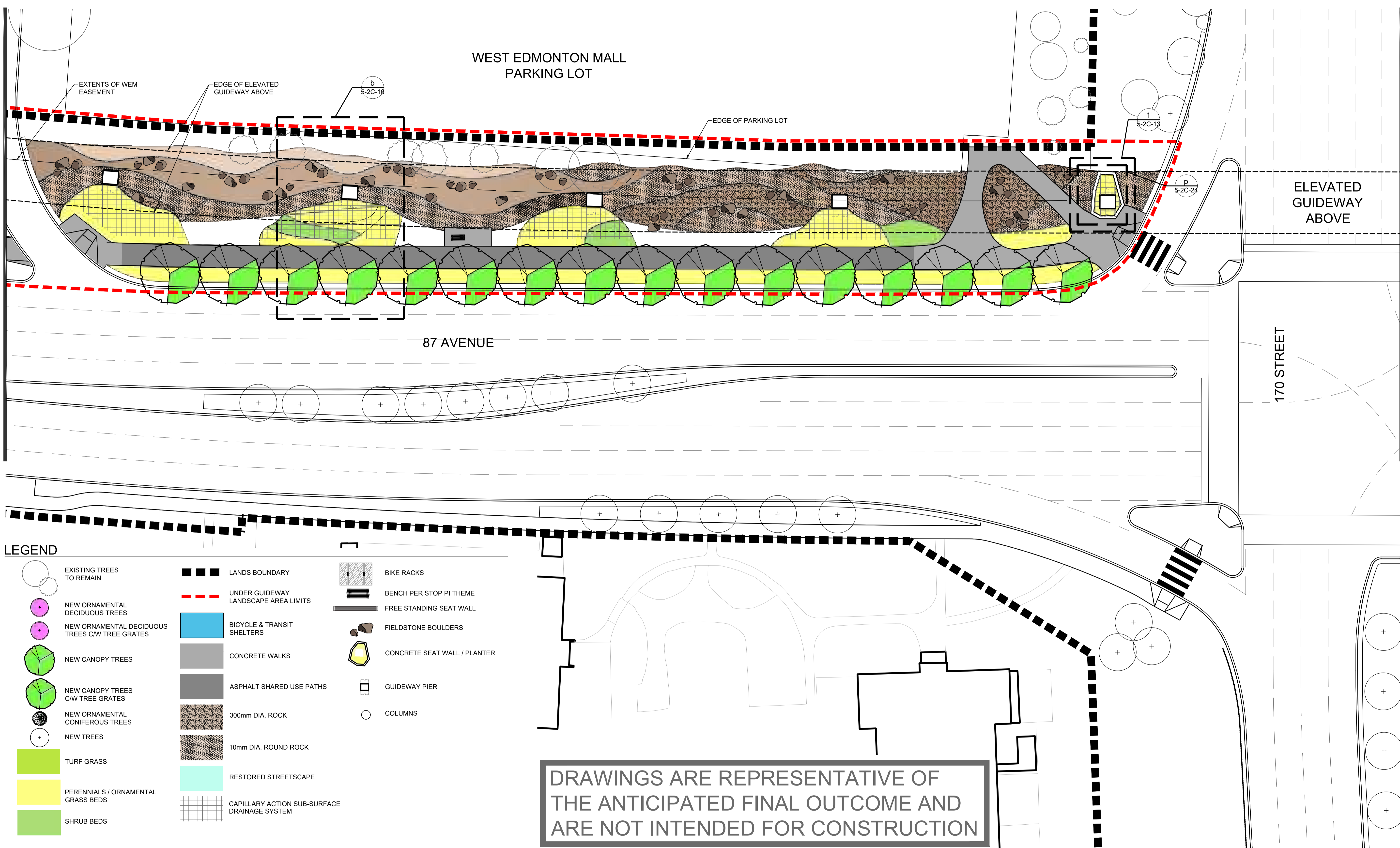

LEGEND

- | | | | | | |
|--|--|--|--|--|------------------------------|
| | EXISTING TREES TO REMAIN | | LANDS BOUNDARY | | BIKE RACKS |
| | NEW ORNAMENTAL DECIDUOUS TREES | | UNDER GUIDEWAY LANDSCAPE AREA LIMITS | | BENCH PER STOP PI THEME |
| | NEW ORNAMENTAL DECIDUOUS TREES C/W TREE GRATES | | BICYCLE & TRANSIT SHELTERS | | FREE STANDING SEAT WALL |
| | NEW CANOPY TREES | | CONCRETE WALKS | | FIELDSTONE BOULDERS |
| | NEW CANOPY TREES C/W TREE GRATES | | ASPHALT SHARED USE PATHS | | CONCRETE SEAT WALL / PLANTER |
| | NEW ORNAMENTAL CONIFEROUS TREES | | 300mm DIA. ROCK | | GUIDEWAY PIER |
| | NEW TREES | | 10mm DIA. ROUND ROCK | | COLUMNS |
| | TURF GRASS | | RESTORED STREETSCAPE | | |
| | PERENNIALS / ORNAMENTAL GRASS BEDS | | CAPILLARY ACTION SUB-SURFACE DRAINAGE SYSTEM | | |
| | SHRUB BEDS | | | | |

DRAWINGS ARE REPRESENTATIVE OF THE ANTICIPATED FINAL OUTCOME AND ARE NOT INTENDED FOR CONSTRUCTION

no.	description	date	checked
3	ISSUED FOR PA V4	18-09-20	J.S.
2	ISSUED FOR PA V3	23-07-20	J.S.
1	ISSUED FOR PA V1	01-05-20	B.D.
	revisions		

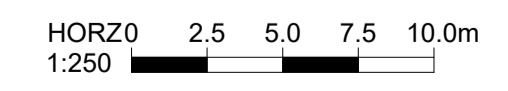

NOT FOR
CONSTRUCTION

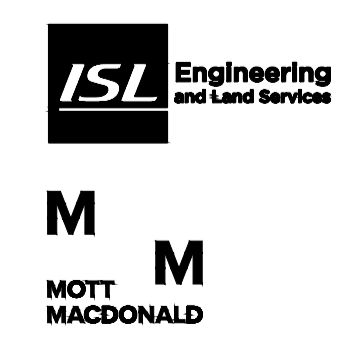

LANDSCAPE
UNDER GUIDEWAY LANDSCAPE AREA

DRAWING NO: 5-2C-7

BD\WORK\September 14, 2020\G:\PROJECTS\1400014854_VALLEY_LINE_LRT_WEST_DESIGN_C6202_CADD\2020_DRAFTING\2020_LANDSCAPE\AREA14854_LG_LAND.DWG



MATCHLINE - REFER TO DRAWING 5-2C-7

MATCHLINE - REFER TO DRAWING 5-2C-9

VALLEY LINE WEST LRT

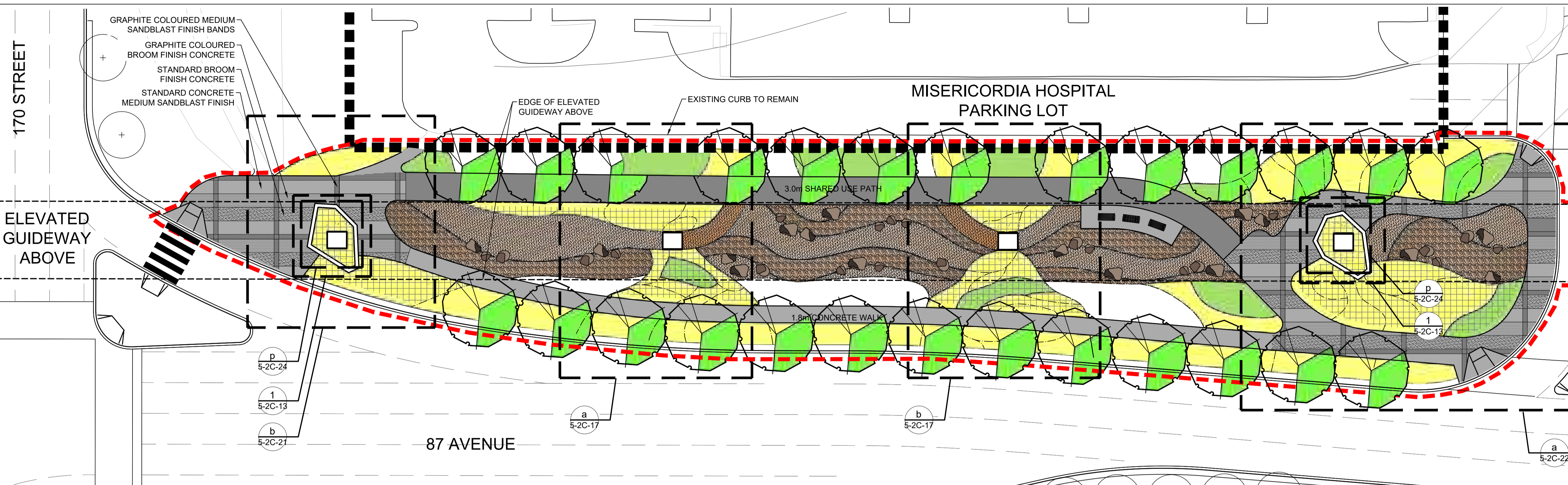

LEGEND

- EXISTING TREES TO REMAIN
- NEW ORNAMENTAL DECIDUOUS TREES
- NEW ORNAMENTAL DECIDUOUS TREES C/W TREE GRATES
- NEW CANOPY TREES
- NEW CANOPY TREES C/W TREE GRATES
- NEW ORNAMENTAL CONIFEROUS TREES
- NEW TREES
- TURF GRASS
- PERENNIALS / ORNAMENTAL GRASS BEDS
- SHRUB BEDS
- LANDS BOUNDARY
- UNDER GUIDEWAY LANDSCAPE AREA LIMITS
- BICYCLE & TRANSIT SHELTERS
- CONCRETE WALKS
- ASPHALT SHARED USE PATHS
- 300mm DIA. ROCK
- 10mm DIA. ROUND ROCK
- RESTORED STREETSCAPE
- CAPILLARY ACTION SUB-SURFACE DRAINAGE SYSTEM
- BIKE RACKS
- BENCH PER STOP PI THEME
- FREE STANDING SEAT WALL
- FIELDSTONE BOULDERS
- CONCRETE SEAT WALL / PLANTER
- GUIDEWAY PIER
- COLUMNS

DRAWINGS ARE REPRESENTATIVE OF THE ANTICIPATED FINAL OUTCOME AND ARE NOT INTENDED FOR CONSTRUCTION

no.	description	date	checked
3	ISSUED FOR PA V4	18-09-20	J.S.
2	ISSUED FOR PA V3	23-07-20	J.S.
1	ISSUED FOR PA V1	01-05-20	B.D.
revisions			

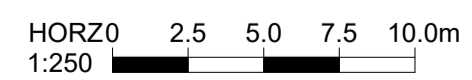

NOT FOR CONSTRUCTION

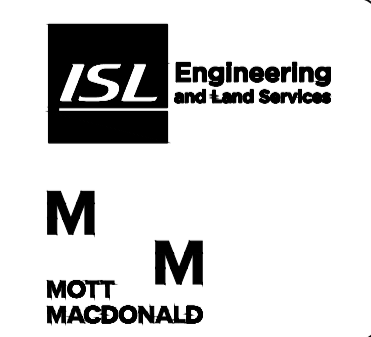

LANDSCAPE UNDER GUIDEWAY LANDSCAPE AREA
DRAWING NO: 5-2C-8



DRAWINGS ARE REPRESENTATIVE OF THE ANTICIPATED FINAL OUTCOME AND ARE NOT INTENDED FOR CONSTRUCTION

LEGEND

- BIKE RACKS
- BENCH PER STOP PI THEME
- FREE STANDING SEAT WALL
- FIELDSTONE BOULDERS
- CONCRETE SEAT WALL / PLANTER
- GUIDEWAY PIER
- COLUMNS
- EXISTING TREES TO REMAIN
- NEW ORNAMENTAL DECIDUOUS TREES
- NEW ORNAMENTAL DECIDUOUS TREES C/W TREE GRATES
- NEW CANOPY TREES
- NEW CANOPY TREES C/W TREE GRATES
- NEW ORNAMENTAL CONIFEROUS TREES
- NEW TREES
- TURF GRASS
- PERENNIALS / ORNAMENTAL GRASS BEDS
- SHRUB BEDS
- LANDS BOUNDARY
- UNDER GUIDEWAY LANDSCAPE AREA LIMITS
- BICYCLE & TRANSIT SHELTERS
- CONCRETE WALKS
- ASPHALT SHARED USE PATHS
- 300mm DIA. ROCK
- 10mm DIA. ROUND ROCK
- RESTORED STREETSCAPE
- CAPILLARY ACTION SUB-SURFACE DRAINAGE SYSTEM

MATCHLINE - REFER TO DRAWING 5-2C-8

MATCHLINE - REFER TO DRAWING 5-2C-10

VALLEY LINE WEST LRT

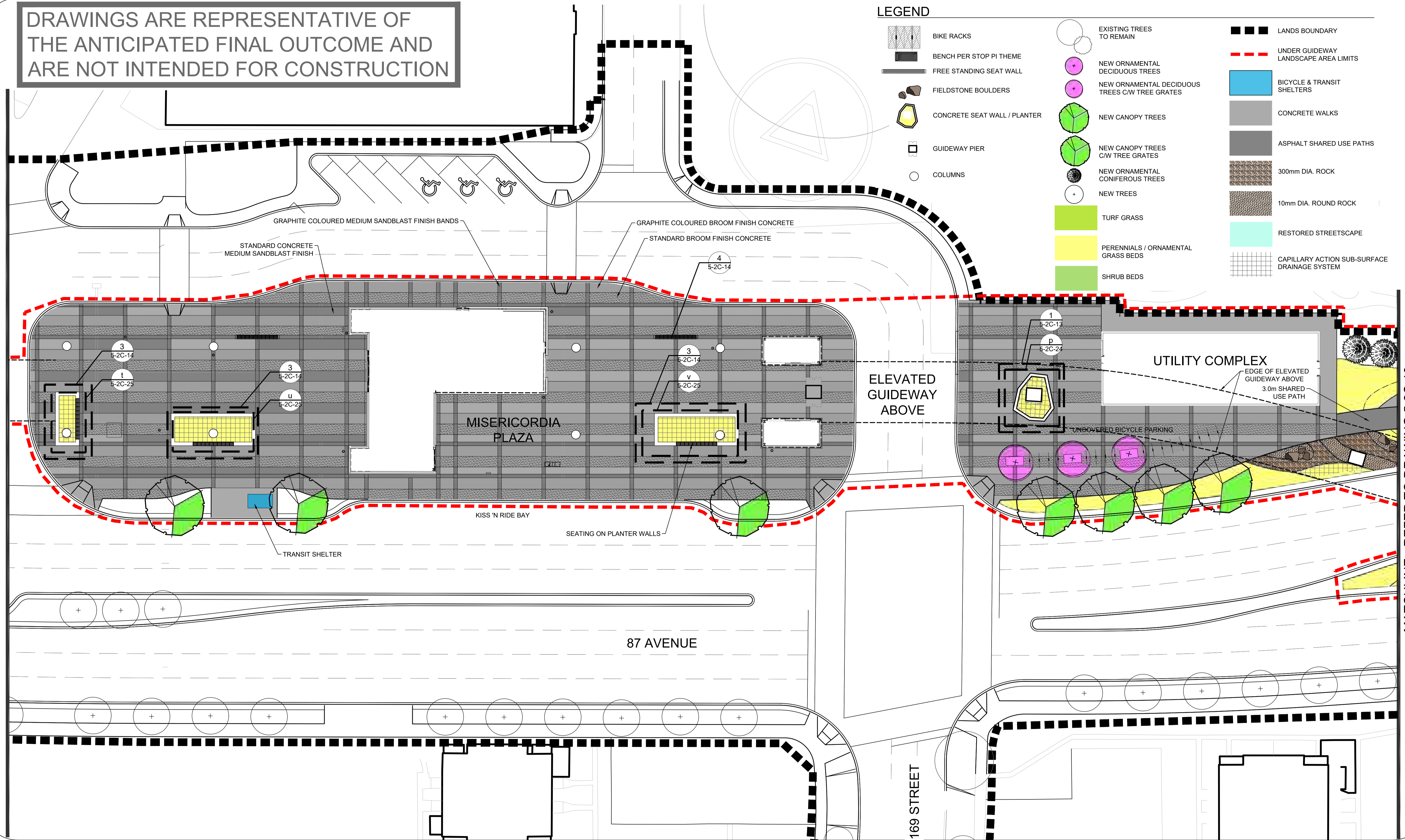

no.	description	date	checked
3	ISSUED FOR PA V4	18-09-20	J.S.
2	ISSUED FOR PA V3	23-07-20	J.S.
1	ISSUED FOR PA V1	01-05-20	B.D.
	revisions		

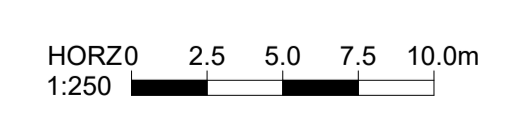

NOT FOR CONSTRUCTION

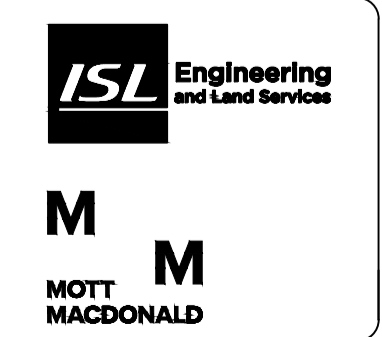

LANDSCAPE UNDER GUIDEWAY LANDSCAPE AREA
DRAWING NO: 5-2C-9

BD\DAVIDSON\September 14, 2020\G:\PROJECTS\140001\48001\4854_VALLEY_LINE_LRT_WEST_DESIGN_C6302_CADD\20_DRAFTING\2020_LANDSCAPE\0411_00_LOCAL_XREF\17_UNDER GUIDEWAY LANDSCAPE AREA\4854_LG_LAND.DWG



B:\DWG\2019\September 14, 2020\G:\PROJECTS\1400014864\VALLEY_LINE_LRT_WEST_DESIGN_C6202_CADD\20_LANDSCAPE\2000_LANDSCAPE\AREA\4864_LUG_LAND.DWG

MATCHLINE - REFER TO DRAWING 5-2C-9

MATCHLINE - REFER TO DRAWING 5-2C-10

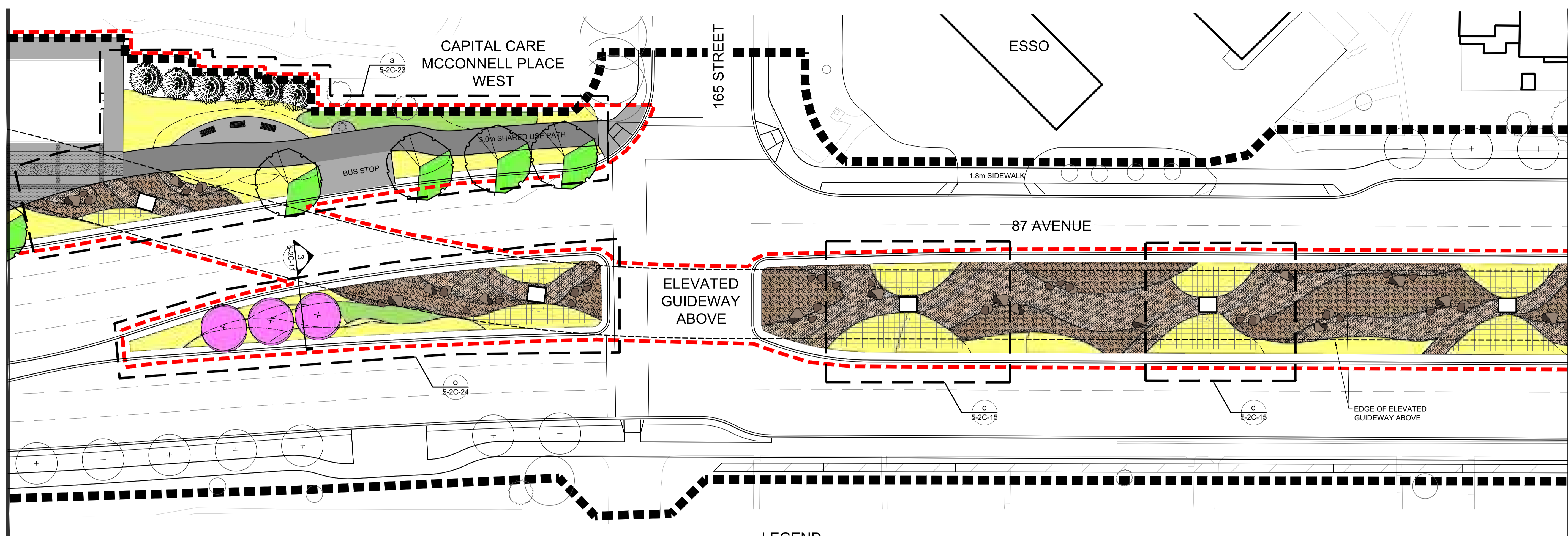

MATCHLINE - REFER TO DRAWING 5-2C-10

VALLEY LINE WEST LRT

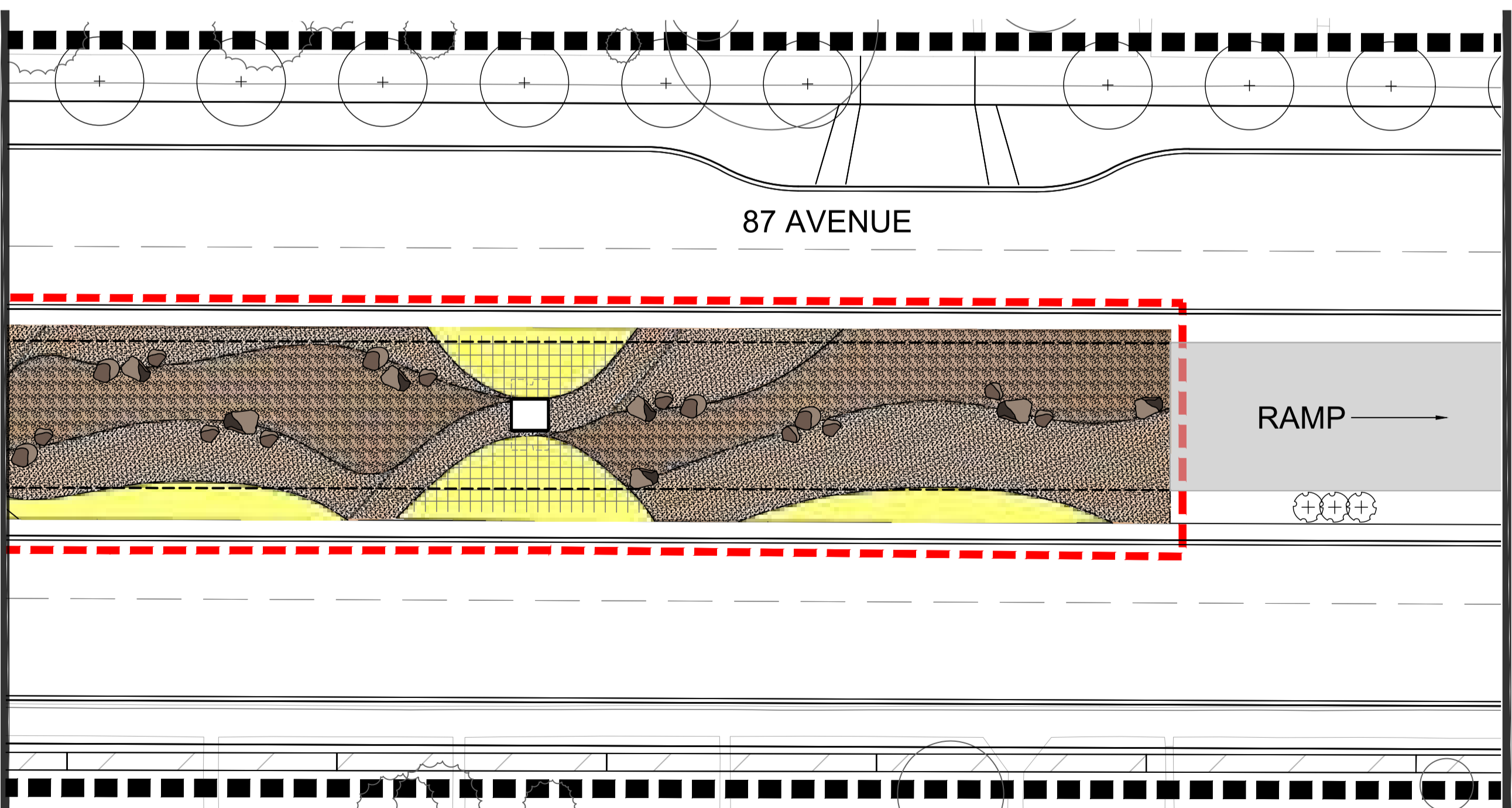

LIMIT OF UNDER GUIDEWAY LANDSCAPE AREA

LEGEND

- EXISTING TREES TO REMAIN
- NEW ORNAMENTAL DECIDUOUS TREES
- NEW ORNAMENTAL DECIDUOUS TREES C/W TREE GRATES
- NEW CANOPY TREES
- NEW CANOPY TREES C/W TREE GRATES
- NEW ORNAMENTAL CONIFEROUS TREES
- NEW TREES
- TURF GRASS
- PERENNIALS / ORNAMENTAL GRASS BEDS
- SHRUB BEDS
- LANDS BOUNDARY
- UNDER GUIDEWAY LANDSCAPE AREA LIMITS
- BICYCLE & TRANSIT SHELTERS
- CONCRETE WALKS
- ASPHALT SHARED USE PATHS
- 300mm DIA. ROCK
- 10mm DIA. ROUND ROCK
- RESTORED STREETSCAPE
- CAPILLARY ACTION SUB-SURFACE DRAINAGE SYSTEM
- BIKE RACKS
- BENCH PER STOP PI THEME
- FREE STANDING SEAT WALL
- FIELDSTONE BOULDERS
- CONCRETE SEAT WALL / PLANTER
- GUIDEWAY PIER
- COLUMNS

DRAWINGS ARE REPRESENTATIVE OF THE ANTICIPATED FINAL OUTCOME AND ARE NOT INTENDED FOR CONSTRUCTION

no.	description	date	checked
3	ISSUED FOR PA V4	18-09-20	J.S.
2	ISSUED FOR PA V3	23-07-20	J.S.
1	ISSUED FOR PA V1	01-05-20	B.D.
revisions			

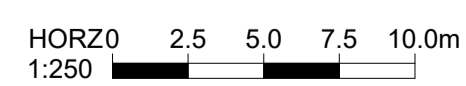

NOT FOR
CONSTRUCTION



LANDSCAPE
UNDER GUIDEWAY LANDSCAPE AREA

DRAWING NO: 5-2C-10